

FALCON™

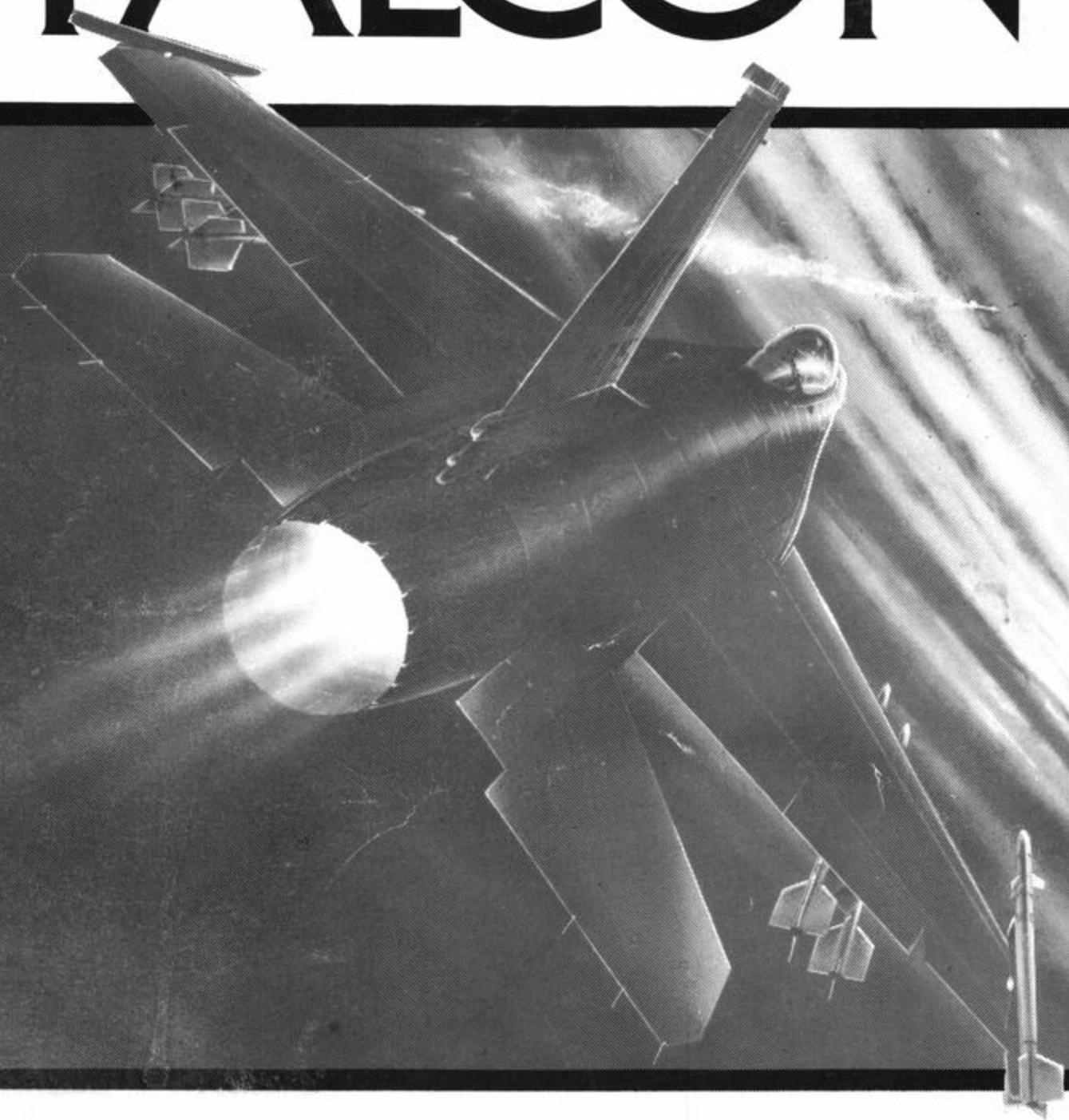

THE F-16 FIGHTER SIMULATION

FALCON , Spectrum HoloByte, and the Spectrum HoloByte logo are trademarks of Sphere, Inc.

Copyright © 1988 Sphere, Inc. All rights reserved.

Published in Europe by Mirrorsoft Ltd

FALCON has been and is being developed for many computer formats. The screen samples and example drawings in this manual have been selected to properly represent all the features of the simulation, regardless of the particular format being discussed. Screen resolution and item location on your computer format may differ slightly from the examples shown. However, any screen differences will be minor and cosmetic in nature. The program functions exactly as stated in the manual.

FALCONTM

Good airplanes are more important than superiority in numbers.

Air Vice-Marshal J.E. "Johnnie" Johnson, RAF

FLIGHT MANUAL

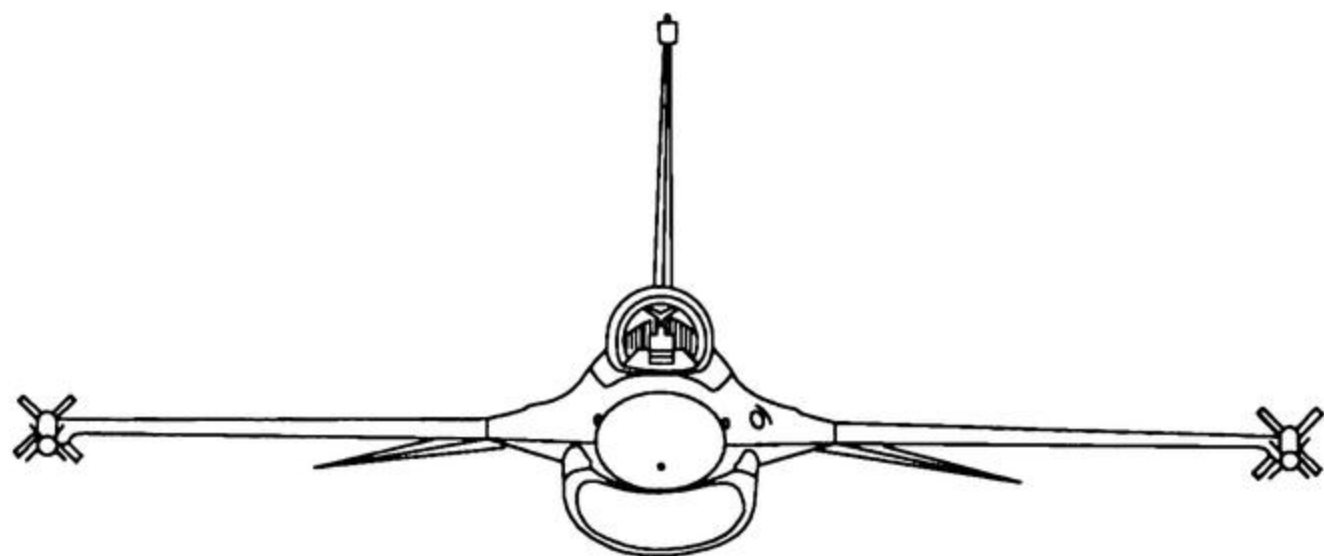

Spectrum HoloByte™

division of Sphere, Inc.
2061 Challenger Drive
Alameda, CA 94501
(415) 522-3584

FALCON concept and design by Gilman "Chopstick" Louie.
ATARI ST and Amiga versions programmed by Chris Orton, Colin Bell, Russell Payne.
Program graphics by Martin Wainwright, David Whitenide.
Sound effects by Russell Payne, Judy Fisher. Conversions managed by Rod Hyde.

Falcon published in Europe by Mirrorsoft Ltd..

If you have questions regarding the use of **FALCON**, or any of our other products, please call Mirrorsoft Customer Support:

(01) 377 4645

or write to:
Mirrorsoft Ltd
Headway House
66-73 Shoe Lane
London EC4P 4AB

This program is dedicated to the brave men and women of the U.S. Armed Forces, and to the employees of General Dynamics, who make a heck of an airplane.

Contents

Introduction	1
<i>About This Manual</i>	1
Hardware Requirements	3
Part I: Your First Flight in the FALCON	5
Setup and Loading Instructions	6
Cockpit Orientation	14
Takeoff Procedure and First Flight	20
Encountering the Enemy	37
Part II: The FALCON Experience:	
A Guide to the F-16	47
Keyboard Command Layout	48
Keyboard Command Descriptions	49
The FALCON Armament	54
The FALCON Cockpit	58
<i>Head-Up Displays (HUD)</i>	58
<i>Front Panel</i>	78
<i>Left View</i>	89
<i>Right View</i>	91
Part III: Military Ranks and Missions	95
The Ranks	96
The Missions	100
<i>Mission Results: Snapshots, Awards, and Merits</i>	106
Part IV: Advanced Fighter Training	112
General Flight Performance of the F-16	113
Air Combat Maneuvers	121
Black Box	127
Glossary and Abbreviations	131
The F-16: Specifications	134
The MiG-21: Specifications	135
Index	137
Additional Reading	141

Introduction

*Our hopes, like towering falcons, aim
At objects in an airy height;
The little pleasure of the game
Is from afar to view the flight.*

Matthew Prior

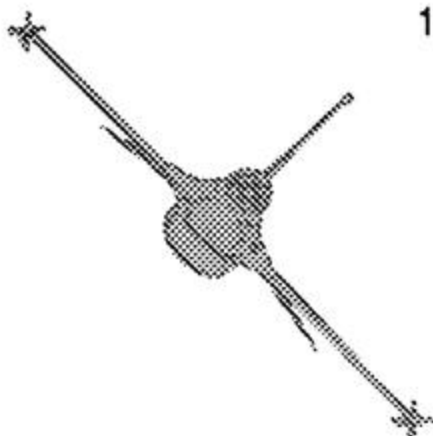

In the wild, the falcon is the most effective predator for its size compared to any other. While many birds hunt for their prey nocturnally, the falcon searches only during the day, being an aggressive natural hunter. It is considered to be equally as effective at fighting in the air as striking a target on the ground.

This natural inspiration spurred development of the most versatile jet fighter in the air today, the F-16A Fighting Falcon from General Dynamics.

FALCON was designed to be a highly realistic simulation of the F-16, yet you have the opportunity to fly this powerful jet with tremendous ease. As you progress in flying skill, the ability to take over more control of **FALCON's** detailed F-16 features will strongly test your mastery of flying in air combat, and provide many hours of enjoyment.

About This Manual

Fighter pilots have to spend much of their lives learning everything there is to know about their airplanes, along with understanding the enemy's planes and pilots they may go up against in battle. A considerable time will pass in training before they even take a seat in a fighter jet. We obviously don't plan to put you through such rigorous training just so you can fly **FALCON**. However, in such a thorough simulation, there is a great deal to learn over the course of playing **FALCON** that will determine how well you perform, especially at the upper levels.

Therefore, in **Part I** of the manual, we're going to send you for a test flight at the lowest level of the program. This will enable you to get a feel for the basics of flying the F-16. Most of the plane's true characteristics will be toned down a bit, and it will be impossible to crash or be shot down.

After you've gone for a few introductory flights and are feeling pretty comfortable, read **Part II** of the manual to learn all the commands available to you while flying the **FALCON**, along with a few hints about what to expect while flying at the higher levels of the program. We cover some of the basics that one has to learn in order to be trained as a real fighter pilot.

FALCON presents game difficulty levels according to a military pilot's rank. **Part III** covers the different ranks that you'll be striving to perform at, from First Lieutenant all the way to Colonel. This section also covers the variety of air-to-air combat and ground strike missions that you can select from.

Part IV moves deeper into the strategy and tactics involved in air combat, including maneuvers that the enemy MiGs will be performing as they engage you in dogfights. Learning how to perform some basic maneuvers yourself will help your performance at upper levels of the simulation.

We have purposely designed the lower levels of the program to be relatively easy to perform, so you can gradually develop the skills necessary to enter combat at higher ranks. If you're familiar with how jet fighters like the F-16 operate, either through reading or the play of other computer simulations (Maybe you're a real fighter jock!), you may be tempted to skim over the manual and dive into the upper levels of the simulation. Be forewarned though, at the Colonel level of **FALCON**, the simulation is very faithful to the operation of the real F-16, and the MiGs you will be battling are close to invincible.

We recommend that you fly at the lower ranks until you have a firm grasp of the plane's characteristics and the nature of air battle. Then you can attempt to rise in rank and fly an increasingly more realistic F-16 against more formidable opponents.

It goes without saying that we want you to have fun playing with **FALCON**. We certainly have! At the same time, we hope we've given you an opportunity to learn a little about an exciting, important subject. And maybe you'll discover, as we did, a newfound respect for the pilots who fly these planes every day in the service of their countries.

Hardware Requirements

FALCON requires:

ATARI

- Atari 520 ST/FM
- Atari 1040 ST/FM

AMIGA

- At least 512k RAM

Note that the black box feature and certain sound and graphic enhancements are only available on the 1 Mb models.

A joystick or mouse is optional.

- If you plan to employ the option to direct-connect two machines and dogfight against another **FALCON** owner, you'll need a special cable (or cables) to connect the two machines. *See the special insert for information on this option.*

Future Plans for FALCON

Let us know what you like and dislike about the program so we can reflect your wishes when releasing updated versions. We plan to enhance and provide additional disks for **FALCON** over time so that it remains the premier jet fighter simulation on personal computers. Returning your registration card is the first step in making sure you'll know all that is planned. Be a part of the process and tell us what you want to see in the program!

Part I: Your First Flight in the FALCON

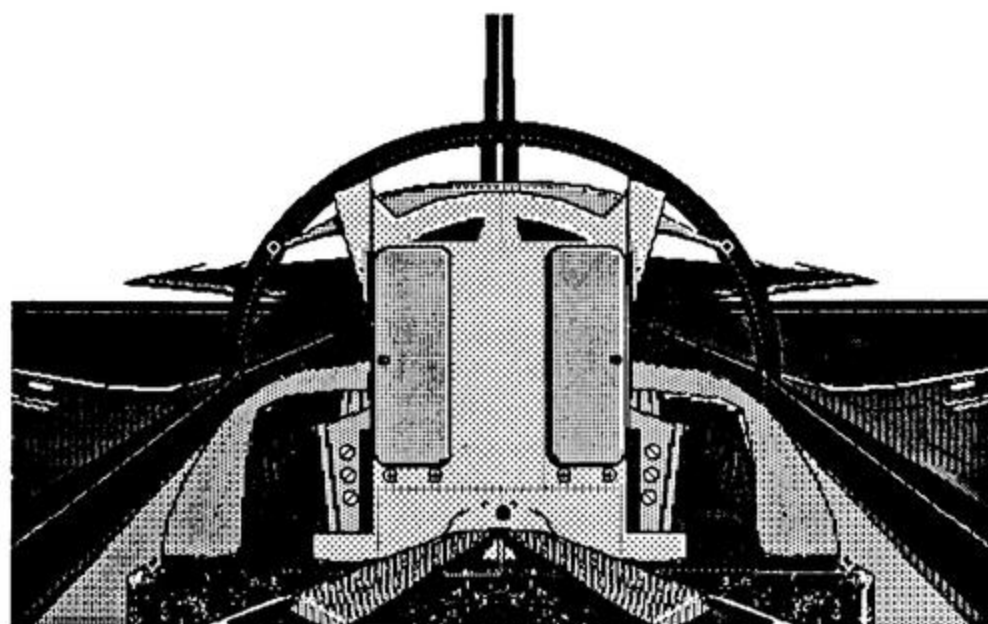

ARMAMENT			
AIM 19J	169lb	4	
 Sidewinder			
AIM 9L	195lb	0	
 Sidewinder All Aspect			
AGM 65	464lb	0	
 Maverick			
Mk 84	1970lb	2	
 2000lb Low Drag			
Durandal	751lb	0	
 Anti-Runway			
ALQ 131	675lb	0	
 ECM			
300 gal	2304lb	0	
 Fuel Tank			
<p>Good Morning, Sir. How's the wife and kids?</p>			
TOTAL WEIGHT: 27707			

Setup and Loading Instructions

It is assumed that you are familiar with the basic terms and operations of your computer. If this is the first program you have run on your computer, refer to the Owner's Manual to become familiar with how to operate your system.

Loading the Program

ATARI ST

- Insert disk and reset your system, insert disk 2 on the screen prompts.

AMIGA

- Insert the Amiga kickstart disk in the drive (this is not necessary if you have an A500 or an A2000). When the "Workbench" icon appears on the screen, press the eject button and remove the kickstart disk. Insert FALCON 1 disk in the disk drive. It loads automatically. Insert disk 2 on the screen prompts.

Menus

When **FALCON** has loaded you will see the DUTY ROSTER, on top of which is a list of menus. With the exception of the COMMS menu, these menus are not operable until you have made your armament selection. However it is appropriate at this stage to give an explanation of the menus.

File

The following options are available:

- Return to cockpit — Used where you have pressed the Esc key to make a choice from one of the menus.
- Abort Mission — Returns you to the Duty Roster
- End Mission — When you have completed a mission and landed safely, choose this option to see the Awards screen.
- Read Mission Disk — You will not need this option until you have purchased a Mission Disk.

- Quit — Returns you to the computer operating system.

ACM

- This option enables you to practice Air Combat Maneuvers. See the section entitled “Air Combat Maneuvers” for details of the maneuvers.

Scenery

- Dots only
- Detail only
- Dots and Detail

The less the scenery on display the faster the program will run.

Control

- Mouse
- Keyboard
- Joystick
- Mouse 2 (You are able to “centre the stick” by clicking and releasing the right hand mouse button.

Options

- Normal scale
- Large scale

You are able to change the size of the MiGs.

- Sound on
- Engine off
- Sound off

We recommend that you play with the sound of the engine off.

- Training

With this option you will see that in ACM the MiG will have his flight path indicated by squares which you should fly through to if you wish to follow his track.

- Super MiG — If you think the normal MiG pilots are not good enough, try this option!

COMMS

Leave this choice at the default selection of **SINGLE PLAYER**. If you are going to be the only participant experiencing **FALCON** (on one machine), as would normally be the case. However, if you wish to hook your machine up to another so you and another player can “dogfight” against each other, select **TWO**. See the insert for information on connecting the two machines.

If you select **TWO** for **NUMBER OF PLAYERS**, make sure the selection for the **BAUDRATE** (speed) that your computers will communicate at is correct.

Duty Roster

The **DUTY ROSTER** maintains a record for up to ten “active” (meaning still alive!) players. The last rank achieved and total “merits” (points) attained are displayed along with the pilots’ names. (*Since no one’s played from your disk as yet, all pilot name lines show a call sign of “ROOKIE” with zero merits.*) If you expect to have several people playing the game and want to make sure that someone’s name isn’t accidentally erased, we suggest designating one of the name slots (say, the last one) as the “floater”, for newcomers and occasional players to use.

- On this first entry, highlight any of the “ROOKIE” name lines and click with the mouse button. Type in the name you want to use for yourself at the top. Remember, every fighter jock has a call sign! Be as creative as you like, just keep the name within fifteen characters. (You can use the **Backspace** key to correct any error, and to erase ROOKIE.)

When you’re finished typing your name, press the OK box.

You can override a listed pilot's name at any time if you want to add a new person or name to the game. You might even want to keep separate "names" of yourself for practice reasons. Just make sure not to overwrite an active pilot for whom you want to maintain a record.

The **DUTY ROSTER** includes pilots who are still alive and haven't been either taken as a prisoner of war (POW), or court-martialed for unacceptable actions. This list is different from the "**SIERRA HOTEL**", which contains the top ten **FALCON** pilots who have ever played from your disk, whether they are still alive (ACTIVE); or have been killed in action (KIA), declared missing in action (MIA), or court-martialed (BUSTED), or RETIRED when the pilot's name has been changed.

After you've selected a name for the **DUTY ROSTER**, the next screen allows you to select the level of difficulty at which you will fly, along with the specific objective.

Use the **mouse pointer** to move between topics. Use the mouse button to highlight a selection within a topic. When you are satisfied with your selections, click on the **ARMAMENT** box to proceed to the next screen.

Rank

Select from a listed rank to determine the difficulty level. The order is from **First Lieutenant** (easiest) all the way to **Colonel** (highest difficulty). (Note: Part III of the manual discusses the differences between ranks, plus how they affect your plane's performance and that of the enemy.) You select a rank by simply highlighting the desired rank line and clicking on the name button.

Leave the selection at **1st LT. (First Lieutenant)** for your initial flight.

Missions

This is where you choose from any of twelve different missions involving air-to-air combat, air-to-ground strikes, or a lot of both! There is a ribbon to the left of each mission name, which will be awarded to you if the mission is completed successfully. (Note: Part III of the manual describes details of the different missions.) Just like rank, you select a mission by highlighting the mission name.

Leave the selection at **Milk Run**, which is a simple flying and bombing exercise.

Maximum Number of MIGS

You can choose between zero, one, two, or three as the total number of enemy MiG planes (within rank and mission limits) possible to be onscreen at any particular time. Clicking on the box will cycle through the number of MiG planes you require.

Program speed degradation may occur with more than one plane onscreen at a time, depending on your hardware.

There are no MiGs on the Milk Run mission (if you stay in the mission area, that is!). Even so, just to make sure you don't encounter any this first time up, click on the MAX# of MIGS box to eliminate the MiG picture. You'll have plenty of time to battle the enemy's planes later.

- After you've finished making rank and mission selections, click on the ARMAMENT box to proceed to the armament selection screen.

Armament Selection

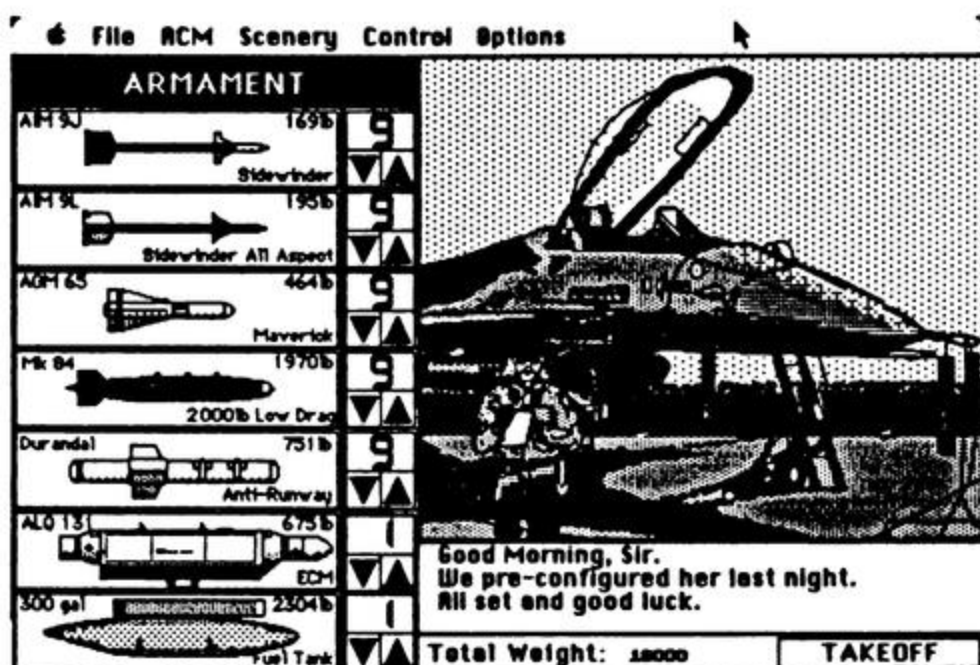

Because you're flying at First Lieutenant level for the first flight, you have unlimited armament available. Therefore, you won't make any choices from the Armament selection screen like you would at other ranks.

Even so, take a look at the Armament selection screen and read the following information just to get familiar with the procedure for future use.

*This is where you make selections to outfit your F-16 for a particular mission or exercise. Actually, what happens is you make **requests** to the crew chief ("Sarge"), and he will inform you whether the armament requested is available. There may be times when certain arms are out of stock, for one reason or another. On busy days at the base, other planes taking off on the adjacent runway may have taken the last of the items you've requested. Situations like these will test your mettle as a pilot, depending on the mission that you've selected to perform. Like most fighter jocks, you realize how important the Sarge and his crew are to your job as a pilot, and you treat them with the utmost respect. (Remember the unspoken law: You're only borrowing "his" plane.) There's no room for ego trips around here, just because you're an officer. Because of the good relationship, Sarge will warn you if he thinks you're arming the plane with too much weight. He'll make sure that your load is symmetric (weight equally distributed) and won't allow the placement of more weapons on a station than is structurally possible; but within these guidelines, the total weight is up to you. Any decisions you make here in arming your F-16 will affect how well the plane performs in the sky (at upper ranks). If you carry too many missiles and bombs on a particular flight, your plane isn't going to maneuver very well, and you can expect a lecture from the Sarge before you take off. You must make your decisions based upon the mission you are embarking on and the armament in stock.*

Selection Procedure (All Ranks Except First Lieutenant)

- **Click on the up or down arrows to the right of each weapon to increase or decrease the number you wish to carry on your mission.** If you request an additional item of any type and the Sarge has it available for you, he'll say so, and the tally number to the right of the weapon will increase accordingly. If you change your mind about any piece of weaponry and decide to **decrease** the amount carried, **click the down arrow** to decrease the number for that particular item, all the way down to zero, if you wish. On any mission that you embark upon (except those at First Lieutenant rank), the program defaults to a basic configuration of (2) AIM-9J Air-to-Air Missiles. Of course, you don't have to accept this basic configuration if you don't want to take these weapons along, and the Sarge has other desired weapons available. (At First Lieutenant rank, nines (9) will appear beside all weapons to show that armament is unlimited. The ALQ-131 ECM Pod and External Fuel Tanks show a one (1), but they are unlimited as well.)

Before flying at Captain rank or higher, you should take a look at the armament configuration drawing on page 56 to see how weapons are placed onto your F-16.

At this point, you may have noticed that the Menu Bar at the top of the screen has become completely activated. You'll learn about all the selections in due time, but for now the only menu selection you need to make is the device you will be using as your F-16's directional

("stick") control. Pressing `Esc` will bring up this menu bar during a mission.

Go to the **"Control"** Menu and select **Mouse, Key, Joy or Mouse 2** depending on whether you want to use the mouse, your keyboard, or a Joystick as your respective input device for directional ("stick") control of your plane. Mouse2 is not self centering until the right-hand button is pressed.

***Note:** Fighter pilots have told us that they get a little rusty at using their "stick" (directional control) if they haven't been inside a plane for some time. It takes them a while to get the feel back. Because we've tried to simulate the F-16's handling characteristics so closely, you might want to start off using the **keyboard** for directional (stick) control, because it tends to be a little more forgiving at first.*

IMPORTANT!

Don't make any selections from the ACM Menu at this time or you will go immediately into a training mode for learning Air Combat Maneuvers when you enter the cockpit. These maneuvers require some previous experience with the program for you to use effectively. If you make a selection from this menu by accident and go off into one of the maneuvers, press the `Esc` key to bring the Menu Bar back. Go to the "File" menu and select "Abort Mission" to return to the DUTY ROSTER screen. Make the same choices as before to return to this point.

- When you've completed your selections, click in the **TAKEOFF** box to accept the armament and proceed to "takeoff ready" position. The Sarge will have a few words to say before the armament selection screen disappears. Get in the habit of reading any messages he has for you, because they may save your life later on when you are flying at a higher rank.

Note: You won't exactly be alone in the air after the Sarge signs off. Your ground support crew will contact you occasionally (via messages along the top of your front cockpit view) when MiGs are sighted as well as confirming your successful hits in air battle. They will also notify you when you're flying off course.

Cockpit Orientation

After the Sarge signs off, the next screen has you seated in the **FALCON**, ready for takeoff. Your plane is resting on Runway # 36.

Take some time to get familiar with your F-16. Inside the plane, you are facing the front of the cockpit, which contains the most important displays and controls to be used in the simulation. Look at the components of the cockpit, and compare them to the illustrations in your Flight Manual and reference card. You don't need to know what every item represents just now, since all the F-16's characteristics aren't activated at **First Lieutenant** rank. (All cockpit features are discussed in detail in **Part II** of the Flight Manual.)

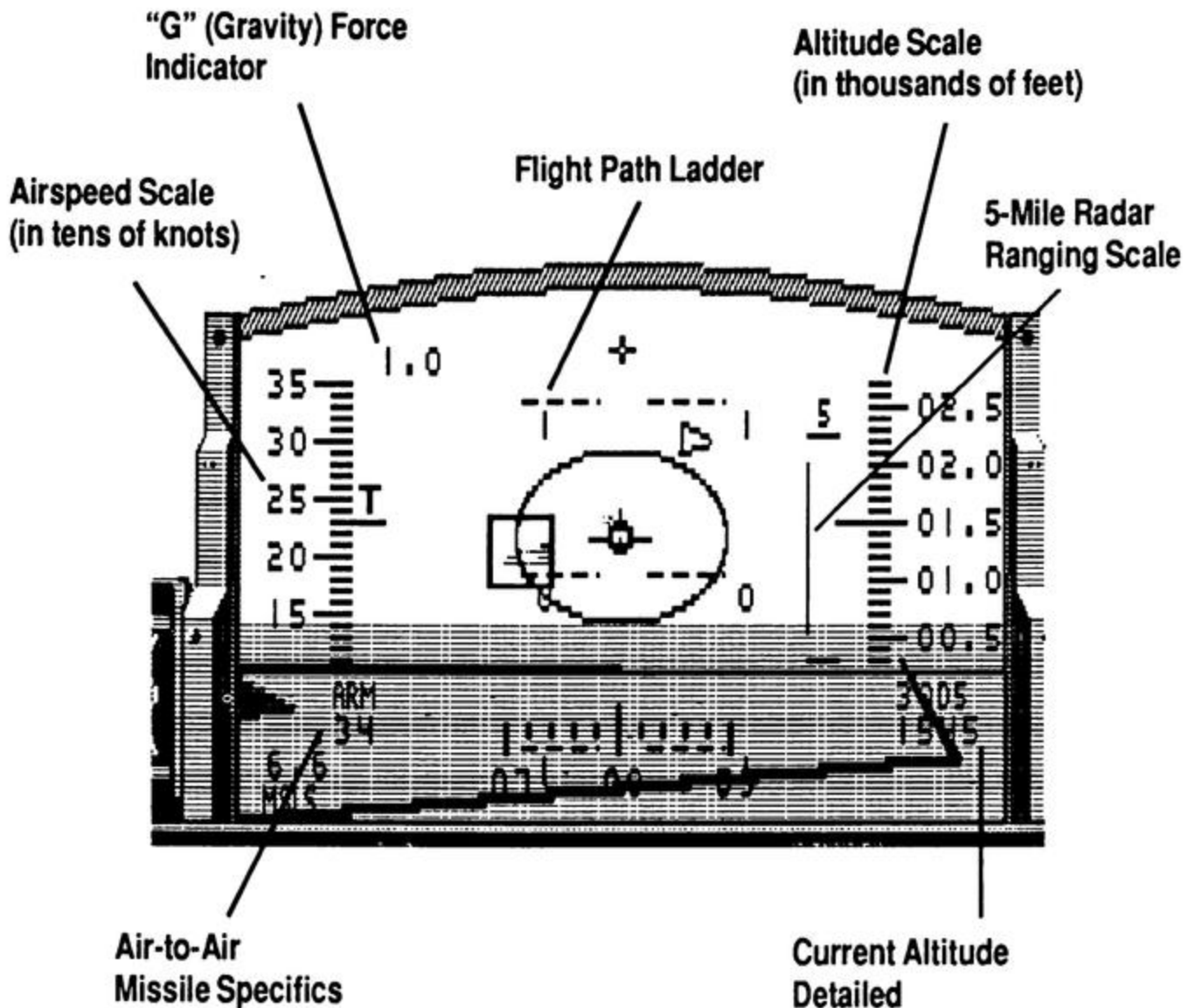

HEAD-UP DISPLAY (HUD) IN "AIR-TO-AIR" MODE

Now, let's discuss the ones you *do* need to watch on your first flight.

- The most prominent feature of the cockpit is the **Head-Up Display**, or **HUD**, which is located in the upper middle of the screen. The HUD is a piece of glass (separate from the canopy) upon which important data is displayed electronically. By having vital information displayed directly in front of your eyes, you don't have to look around the cockpit as much, which helps to maintain your concentration in battle. Although there are several different HUD types, it starts off in "**Air-to-Air**" Mode and displays essential items such as airspeed, heading, gravity forces, altitude, and the flight path ladder.

Brief Description of HUD components

Let's examine the main features of the Air-to-Air HUD.

Flight Path Ladder

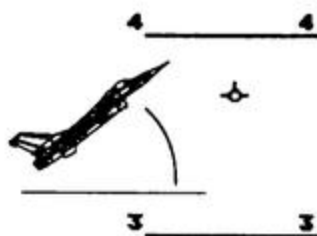

Represents your plane's angle of climb. When positive numbers (0 through 9) are showing, the plane is in an upward climb. Negative numbers (-0 through -9) signify a dive. Each number represents an increment of ten degrees, from 0° to 90° in either direction. The ladder displayed here shows the F-16 in a 38 degree climb. (Negative numbers also shown by dotted line.)



Air-to-Air Missile Specifics (Discretés)

Data relating to the specific HUD mode, in this case "Air-to-Air." The type and status of the weaponry is displayed. You'll learn more about this later.



Aiming Reticle

This represents the effective aiming area for missile hits when battling enemy MiGs. **Part II** will explain its usage.



Airspeed Scale

Displays the plane's true speed (in tens of knots).



"G" (Gravity) Force Indicator

Shows the amount of centrifugal force that is acting upon you and your plane at any time due to a number of factors, including turning (banking) rate and airspeed.



Heading Scale

Displays the direction (magnetic scale, and in tens of degrees) that your F-16 is heading. You should note that the plane starts off on the runway at a 0° heading, which represents due north. East is 90°, south is 180°, and west is 270°.



Altitude Scale

Displays your plane's altitude (in thousands of feet). Note that the current altitude is always detailed at the bottom of the HUD, directly below the Altitude Scale.

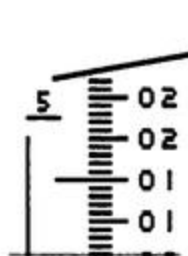

5-Mile Radar Ranging Scale

Specific to Air-to-Air HUDs, this scale's pointer starts to slide downward when an enemy plane has approached within five miles of your F-16. More on this later

To glance at the other HUD modes, press the **Return** key repeatedly to look at other Air-to-Air Modes (used for dogfighting enemy planes), or press the **Backspace** key in succession to examine Air-to-Ground Modes (used for ground strike missions). The **F7** key brings up a special Landing HUD.

The Rest of the Cockpit

- The **AOA Indexer** (left of the HUD) and **AOA Indicator** (beneath the HUD) are used when landing your plane and during battle. They display your "angle of attack". They aren't necessary at lower ranks, but after your first few landings, become adept at using them because it's a necessary skill for landing the F-16 at higher ranks.

AOA INDEXER

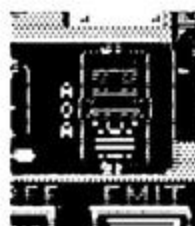

AOA INDICATOR



- The **JFS** (Jet Fuel System) **Start** button will light up when you start your engine.

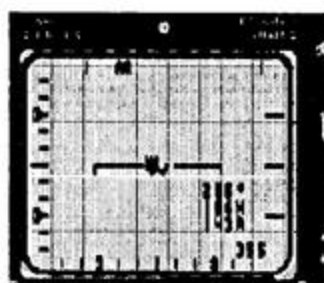

- Directly underneath the HUD glass is a combination Radar/Map screen, called the **COMED** (Combined Map/Electronic Display). It will be the second most-watched item in your cockpit after the HUD. In **Radar** mode, it monitors details like the horizon and relative position of enemy planes to yours. In **Map** mode, it shows your current location in the **FALCON** world, along with landmarks to guide you during missions. Press the "**C**" key to toggle between **Radar** and **Map**. The default selection is **Radar**.



- The **Military Power/Afterburner** Indicator shows whether you are currently invoking the engine's Afterburner (**AB**) for extra acceleration, or if you're using standard Military Power (**ML**), which is a term for normal engine usage and acceleration. Press the "/" key to start the afterburner (stage one). Press the ">" key to increase the afterburner stage up to a maximum of 5. Press "<" to decrease the stage or press "/" (**Slash**) key to go immediately to 100% Military Power. The default setting is **ML**.



- The **Attitude Director Indicator (ADI)** aids in orienting your plane to the horizon while pitching and rolling. Use it in combination with the "waterline" (your plane's position parallel to the horizon) and visual contact with the real horizon to orient the plane directionally.



- The **RPM Gauge** represents the percentage (%) of power that has been applied with the Throttle ("+") key. (This example shows just over 70% of power being applied.)



- The **Wheel Brakes** light is on, signifying that your wheel brakes are set. This keeps the plane from rolling when the engine is started.

Before taking off, take a look out the other views from your cockpit, specifically the **Left View** ("4" key-top row) and **Right View** ("6" key-top row). You'll learn more about the additional gauges and panels later. For now, you might note the initial compass heading in the Left View (**due north**) and how it matches up to the degree heading in the HUD and your current location on the COMED Map mode. These indicators can help you find your way back to the landing strip if you're lost or returning home from a mission that takes place a long distance away.

You also have a variety of out-of-cockpit views that give you an entirely different perspective on the world you are flying in. You might want to take a moment now to examine these different views, although they will probably be more spectacular when you're in the air.

To see a satellite view or look down, press key U. Key 8 will show the tower view, whilst key 9 will show an outsiders view of the F16 (TRACK view). The track view can be seen from a different position by pressing key 2. In addition the view can be zoomed by the use of keys F1 and F2..

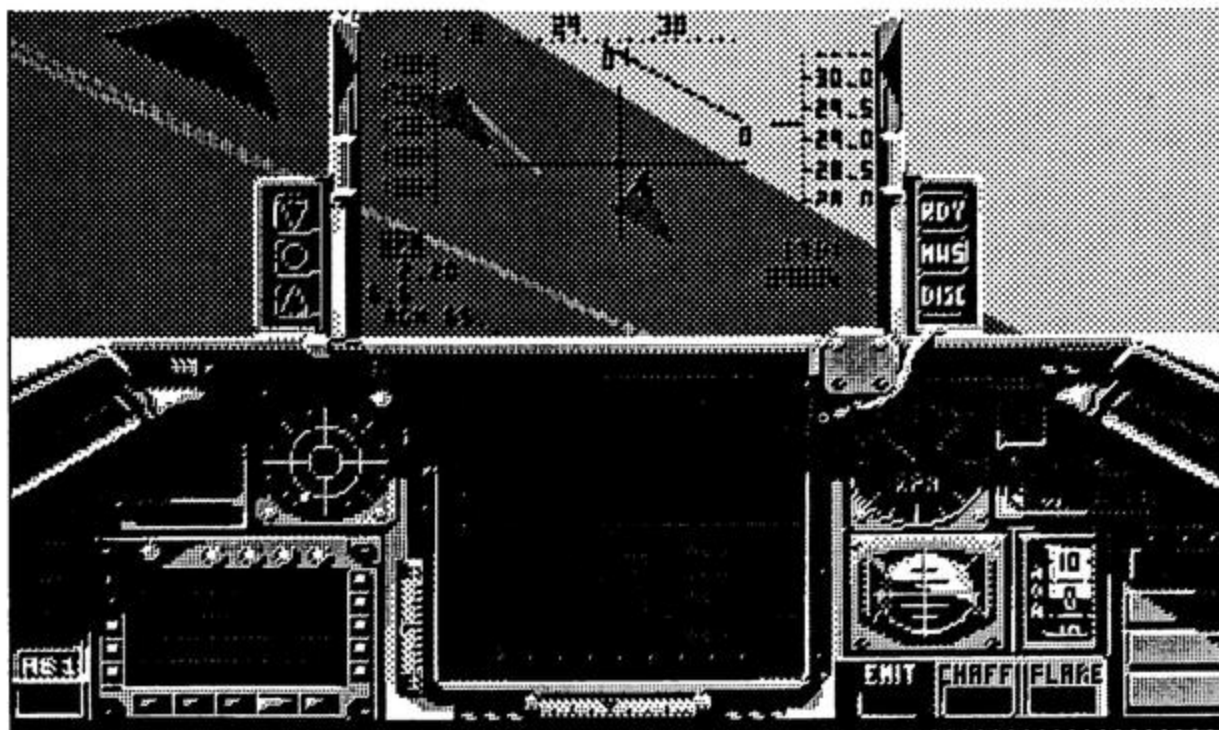

About the Milk Run

The objective of the **Milk Run** mission is to destroy one or more of the buildings located 5 miles east of your home base.

On this mission, you'll use AGM-65 "Maverick" air-to-ground missiles.

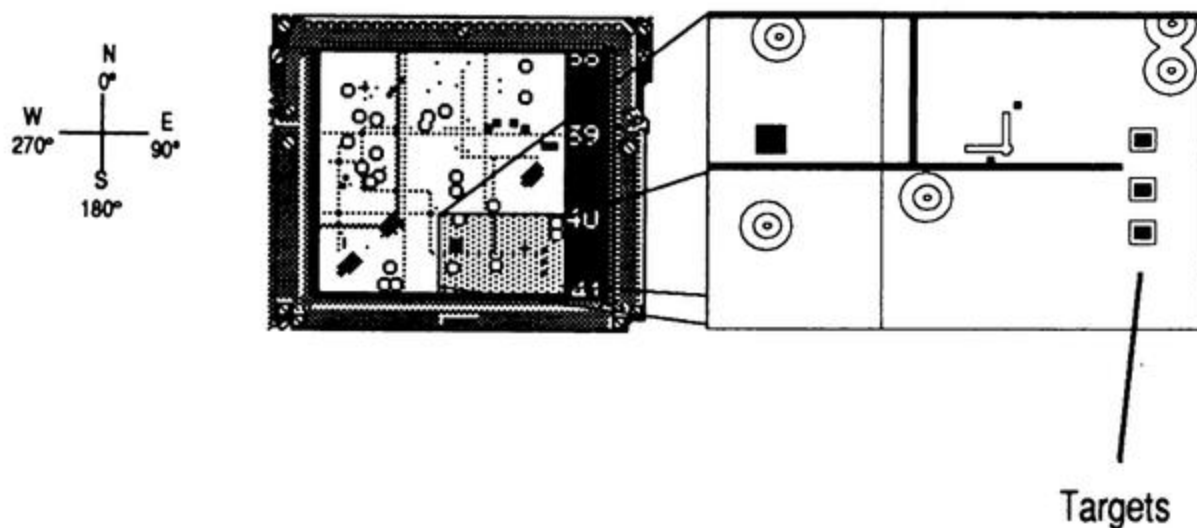

Takeoff Procedure and First Flight

You'll probably want to have your quick reference card close by during the takeoff procedure.

IMPORTANT!

Even though we've tried to pattern this initial flight instruction for a first-time user, the **FALCON** cockpit has so many features that, even at First Lieutenant rank, things may seem overwhelming at first. This is reason enough for including a **"pause"** key in the game. If you're at a certain point in the procedure and want to read ahead to prepare for the next action, simply press the **"P"** key to pause the simulation. When you're ready to continue, press the **"P"** key again to resume flying. After a few flights, everything will become second nature to you.

At times in this section, we'll discuss a procedure in light of what the same situation might require in skill at upper ranks. However, operation-wise, everything still performs according to First Lieutenant rank restrictions. You might want to look at the charts in **Part III** that cover what performance differences occur between the various ranks.

Directional Control (Flying with the "Stick")

Fighter pilots control the directional movement of their planes with a hand control commonly known as the **"stick"**. The following images show the ways you can control the same directional movement of *your* F-16, depending on whether you prefer to use the **keyboard** or a **joystick**.

Throughout the rest of the manual, we will use an **"operation" with the stick** as a common way to describe a needed directional change at a particular time. For example, **"pull back on the stick"** will equate to *pressing the **Down Arrow** (↓) key on the keypad*, or *moving the joystick handle backwards*, depending on the input device you're using. The following images have the corresponding **"stick"** operation printed in boldface next to the particular movement control.

Keyboard

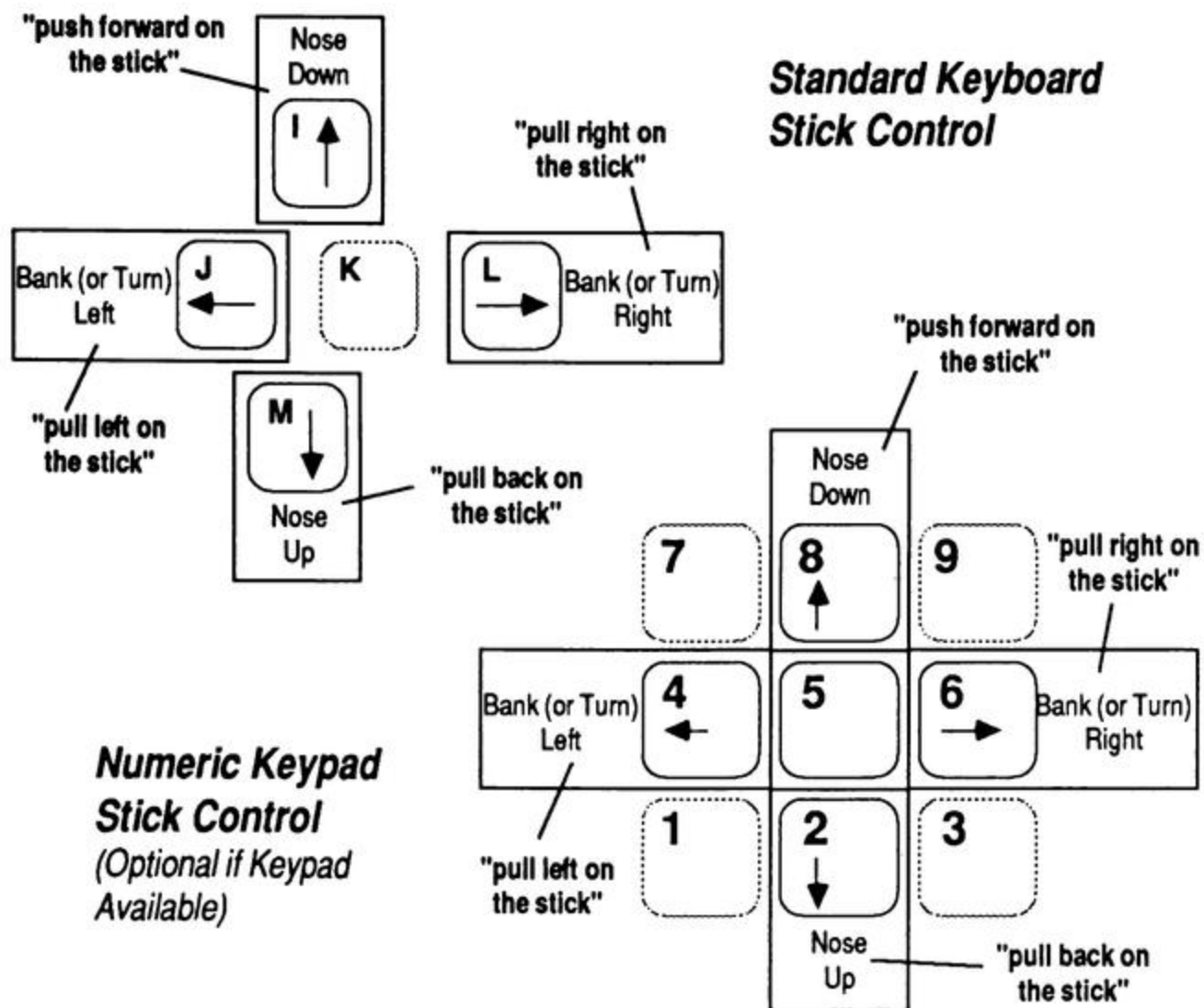

Under the default setup, when you use the keyboard to control directional movement of your plane, the F-16's **stick** automatically centers itself after each keypress. This enables you to easily maintain a constant rate of turn. In other words, if you press the **Left Arrow** (←) key once, your plane will bank left at a small constant rate, and continue to do so until you make another directional change. **If you want to increase the degree of turn (or any other directional change), you need to hold the particular key down for a longer period of time. Also, the longer you hold the particular key down, the faster the rate of change will take place (all other things being equal).**

This is always true at lower ranks (with "super engine"). However, at higher ranks, where your "normal engine" has many factors operating on it, things may not be quite so predictable. Refer to **Part III (Ranks)** on the differences between "super engine" and "normal engine"

Joystick

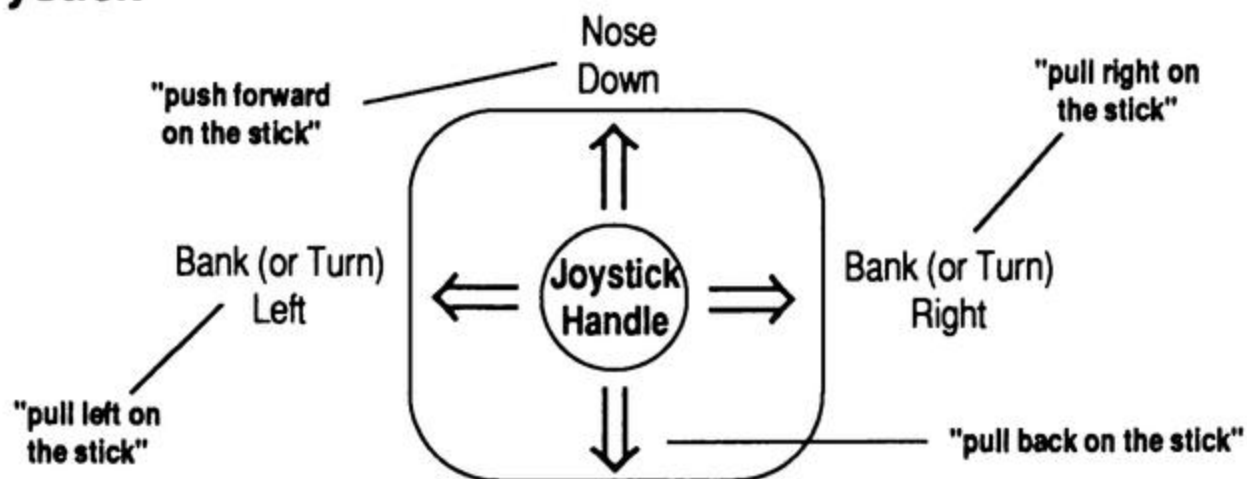

Joystick Button - Trigger (used for firing weapons)

Mouse

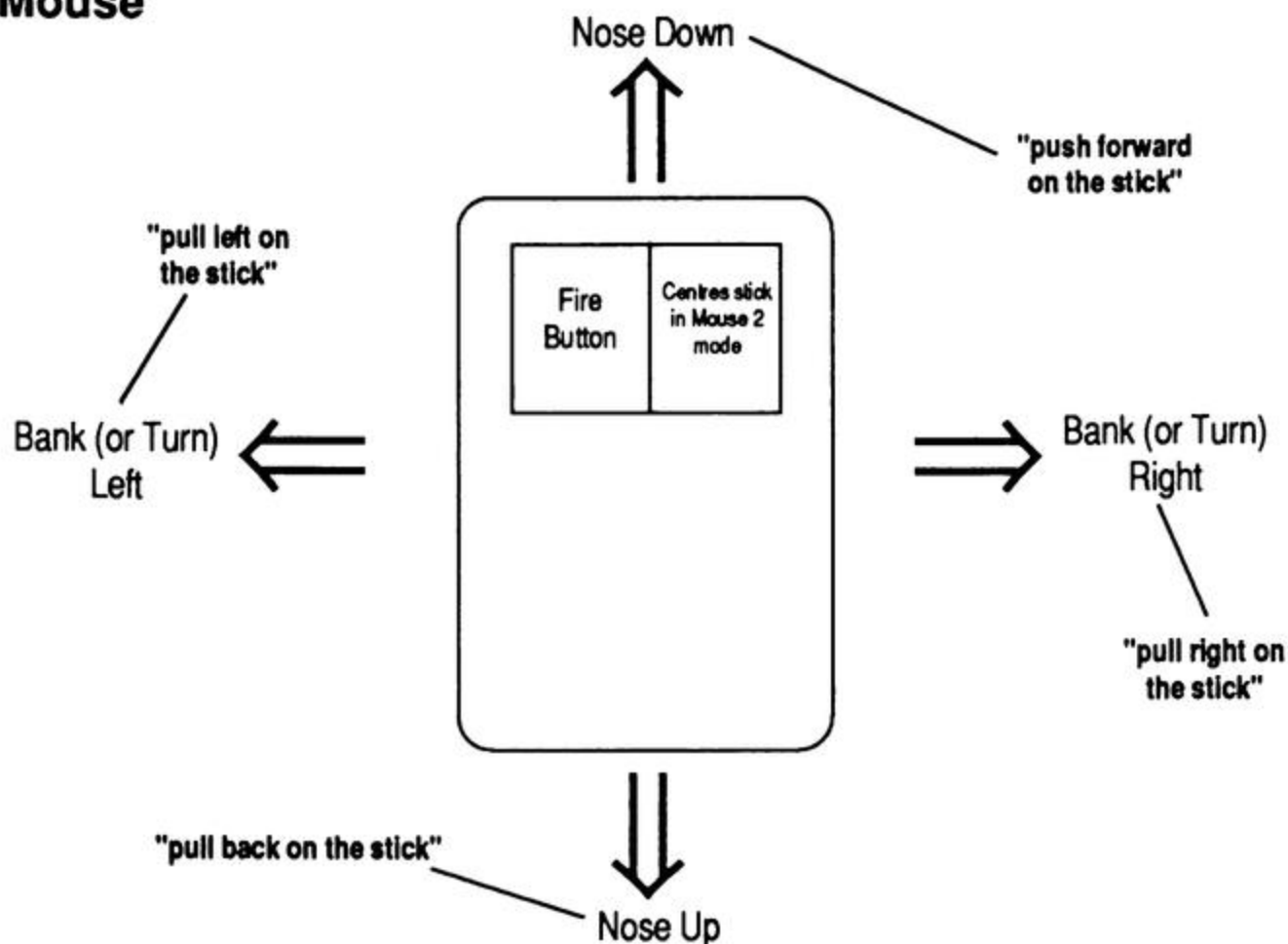

Sliding the mouse in a particular direction to change the pitch or bank of your plane is not so different from using the keyboard. When you slide the mouse to effect a change in any direction, the plane responds by changing its direction until you stop sliding the mouse, which **"centers the stick"**. When the mouse stops moving and the "stick" is therefore "centered", your plane continues on the same path until the mouse is moved again.

Mouse 2

This is an alternative method of mouse control. The "stick" is not centered until the right hand button has been clicked and released.

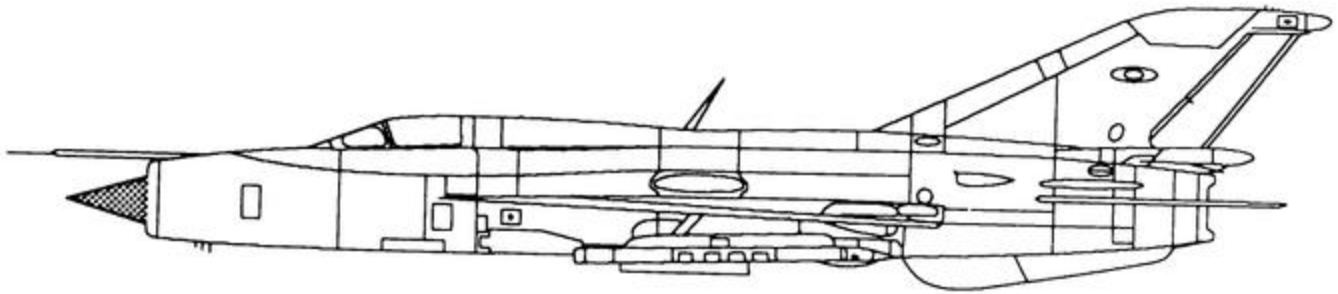

On the Ground

- If you haven't done so already, press the "3" key (top row) to return to the **Front View**.
- Check the front panel to make sure **Wheel Brakes** are engaged (the **WL BRK** light should be on). If not, press the "W" key to apply them. Now it's time to fire 'er up! Activating the **Jet Fuel System** will start the F-100 engine. To engage the JFS, press the **Throttle Increase** key ("+") once and the **JFS Start** light on the front panel will illuminate. By watching the **RPM Gauge**, you'll see the engines automatically rev up to **60% RPM**.

How to Taxi Your Aircraft

Even though it's not necessary to taxi the aircraft, you may want to in order to get familiar with the **Nose Wheel Steering (NWS) System**. To the right of the HUD you'll see the **NWS System/Landing Gear Status Indicator**. The **RY** ("ready") light at the top should be lit, indicating that your Landing Gear (which includes the NWS system) is in "down" position and operational.

- To taxi, rev your engines (to 65%) by pressing the **Throttle Increase** key ("+") until **RPM** reaches **65%**.
- Release the **Wheel Brakes** ("W" key) and your plane should start rolling. **Never exceed 80% RPM with the Wheel Brakes engaged, or your aircraft may be damaged.** Your Nose Wheel Steering light (**NS**: the one in the middle) will illuminate once the plane is moving. At this point you can use the stick controls to steer your F-16 on the runway.
- To turn left, **pull the stick to the left**. To turn right, **pull the stick to the right**. The faster your taxi speed, the wider your turns. Keep taxi speed under 50 knots while varying your throttle to control the speed of the aircraft.

Takeoff

WARNING

Get in the habit of keeping your plane on the runway. Grass takeoffs are fine for whirlybirds, Harriers, insects, and other assorted creatures, but not for your F-16. **At upper ranks, you must stay on the runway unless you want to be permanently grounded!**

- If you haven't already done so, release your Wheel Brakes. (The **WL BRK** light should be off. If not, press "W".)
- Next, hold the **Throttle Increase** key ("+") down until your engines have reached **100% RPM**.
- Continue to roll straight down the runway until your airspeed has reached **150 knots (15 on the HUD Airspeed Scale)**. You'll notice that the **NWS System** light (**NS**) will disengage once your speed has exceeded **90 knots**. **This means that you will no longer be able to steer your aircraft.**

For faster takeoffs and to compensate for heavier payloads, light your Afterburner for that extra needed power (at the expense of using more fuel). **Afterburner (AB)** is engaged by pressing the "/" key. The **AB1** light on the front panel will turn on. *Non-afterburner takeoffs are called full military power takeoffs.* The **ML** indicator light will be on instead of the **AB** light on military power takeoffs.

- When your airspeed reaches the takeoff speed of **150 knots**, **gently pull back on the stick until you reach a climb angle of 8 to 12 degrees**. As your plane leaves the ground, the 10 degree step of the Flight Path Ladder on the HUD should cross the HUD center point, indicating a 10 degree climb angle.

CAUTION

Trying to lift off at speeds less than 150 knots can result in skipping, stalling, or crashing into the runway.



Note that the **DC** (disconnect) light on the **NWS System/LG Status Indicator** illuminates once your plane has left the ground. This serves as a signal to raise the landing gear.

- After takeoff, you need to retract your landing gear by pressing the "G" key. Switch to the **Left View** ("4" key: top row). Look at the Landing Gear (**LG**) Indicator. All three lights should be black if you've successfully raised the landing gear. Switching back to the **Front View** ("3" key: top row), you'll also notice that all lights in the NWS System/LG Status Indicator turn off once the gear has been raised.

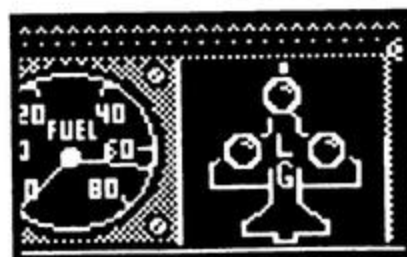

Faster Climb Rate

- You should continue on an **8-12 degree climb angle** until reaching **400 knots airspeed**. At this point you may increase the rate of climb. **A climb angle of 30 to 40 degrees is ideal.** *Afterburner will also increase your climb rate.*

Don't allow your airspeed to fall under 125 knots. There are four ways to increase your airspeed: increase throttle, light the afterburner, dive, or reduce the rate of climb.

Moving into Position and Finding the Target

- Climb to an altitude of **25,000ft** using a **30 degree climb** at **450 knots**. Your engine should be at **72% RPM Military (ML) Power**. "Level off" the plane by **pushing the stick forward** until your **Flight Path Ladder** crosses the center of the HUD at the **0 (zero)** degree step.

The most trustworthy navigational aid you have is your own pair of eyes. As you fly, look around at the different views. Try to identify natural and man-made landmarks such as mountain ranges, bridges, lakes, and buildings.

- Invoke the **Map** mode on your **Combined Map/Electronic Display (COMED)** by pressing the "**C**" key. The **Radar** mode will be replaced with a 2-D reduced map of the **FALCON** landscape.

Note your current position on the map (flashing black square) in relation to those objects around you. After you've played **FALCON** for a while, you'll become familiar enough with the landscape to identify where you are without using the **COMED**. *This will be a very important skill, especially if you navigation system is damaged during combat.*

Since you took off from Runway # 36, your plane should be heading due north. Use your **Compass** on the **Left View** panel or check your **Heading Scale** on the HUD. *(The heading should be 0 (zero) degrees.)*

- Slowly bank your F-16 to the right until the plane is at a 45-50 degree angle. The F-16 should begin a nice easy turn at this bank angle. The steeper the bank, the faster the turn. Speed also affects your rate of turning. It's just like driving a car: the faster you travel, the wider your turn radius. *Travelling at 450 knots, the turn radius will be a little over a mile (6288 feet to be exact), but at 900 knots your turn radius is a staggering 5 miles.*

You'll need to fly toward a new heading of 135 degrees (halfway between 13 and 14 on the **Heading Scale**) to intercept the targets. Ease out of the roll once you've achieved the new heading. Take a look at the map and outside the Front View. You should be heading directly toward the buildings.

Air-to-Ground Missiles

The AGM-65B Missile is designed to be visually locked-on to a ground target by the pilot. In the front end of each Maverick missile is a TV camera with a zoom lens. The television image is fed to the pilot through the **COMED**. *This allows you to acquire your target electronically from distances beyond visual range.*

- Switch your HUD into Air-to-Ground mode by pressing the **Backspace** key. Keep pressing **Backspace** until the **M65** HUD mode indicator appears in the bottom left corner of the HUD. Also, make sure your radar is on ("R"), and that the radar screen rather than the area map is showing on the **COMED**. (Press "C"). Here's an overview of the upcoming missile attempt.
- Once you've visually acquired what looks like your target (one of the three buildings), fly directly toward it. Look down at the radar screen. You may be able to see the target here before you can see it accurately out the cockpit.
- As you move closer to your target, maneuver the **FALCON** so that the crosshairs in the middle of the HUD (and the crosshairs in the middle of the radar screen) are lined up on the target. Press the **Spacebar** to "pickle" or **target designate** the target. The HUD discrete will change from ARM to LOCK, and the target designator (a square) will appear over the target. Note: If the target designator isn't aligned directly over the target, clear the pickle by pressing the **Clear A-G Target Lock** key (X) and try again. Watch for the **In Range** discrete (IN RNG). When it appears, press the **Spacebar** again, and watch the Maverick head for the target.



- *Pull back on your stick to execute a climb, so as to clear the debris area and avoid crashing into the ground. It'll take a few seconds for your missile to reach the target and detonate. If you struck the target, the building image will appear damaged. Otherwise, you'll see a crater in the ground.*

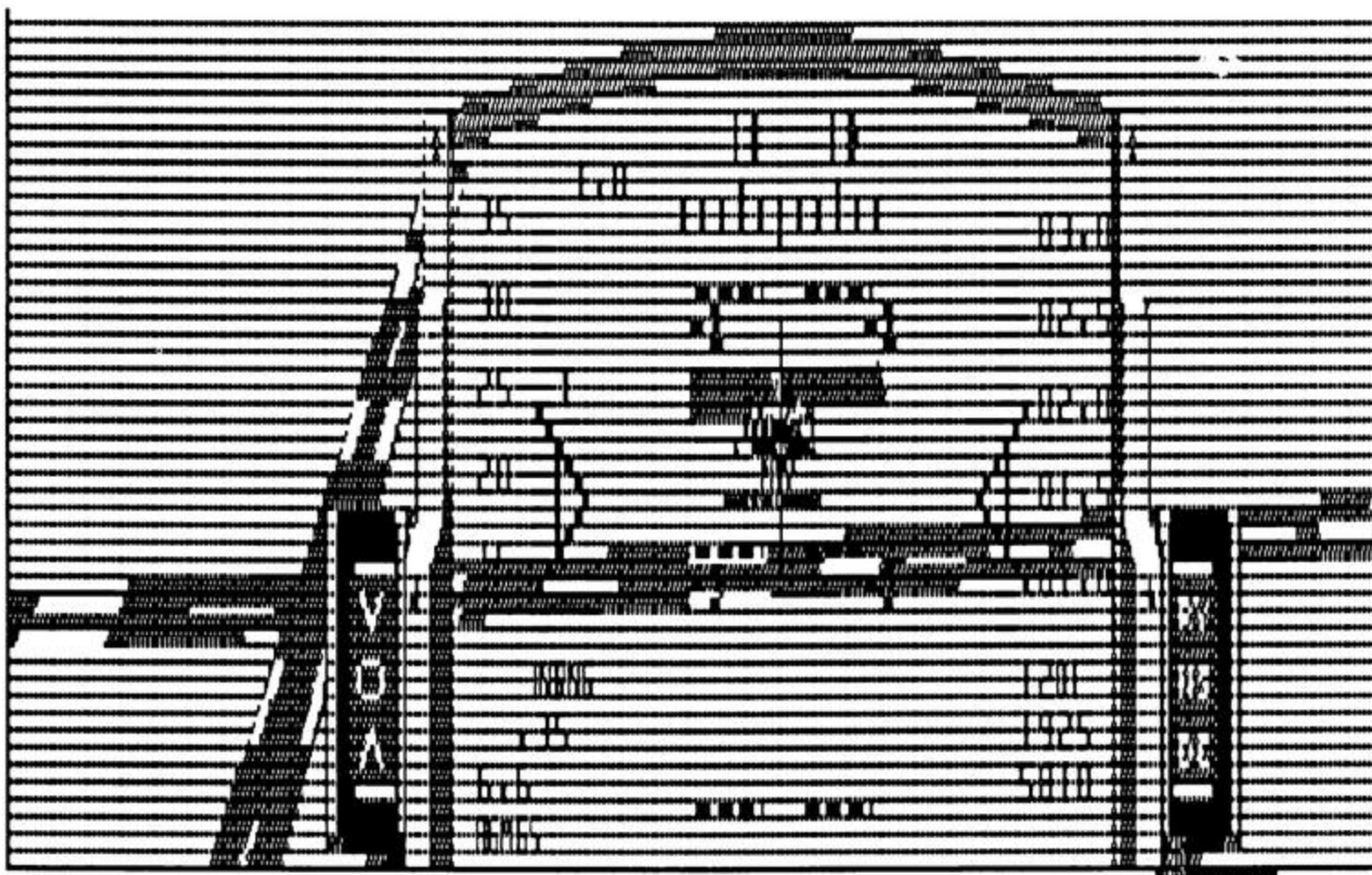

When you try to pull up into a climb at upper ranks, you're going to need all the power you can muster to avoid stalling. Therefore, practice kicking in your **Afterburner** and rev the engine to **100% power**. **Remember: At First Lieutenant rank, you really don't "crash" even if you hit the ground. You're able to get back into the air.** Note the side arrows warning you to pull up.

WARNING!

It's tempting to go back and get a visual confirmation of hitting the target. At **First Lieutenant** rank, this isn't a problem. However, at higher ranks it can be extremely dangerous. You give the enemy more time to get a bearing on your position. Let Intelligence confirm your hits and tell you about them after your mission is completed. Good pilots don't fret about merits and medals. They just want to return their "rented" planes in one piece to the crew chief.

Landing

Getting into the Proper Frame of Mind

Remember, the mission isn't over until your bird is on the ground. Landing takes skilled flying, a steady hand, and a calm state of mind. The worst thing you can do is panic and try to slam your plane onto the ground. A good landing feels as if your plane has floated down onto the runway. *Never be afraid to abort a landing and come around for another try. It's better to be a little embarrassed than end up as a picture on the wall of an airfield cantina.*

Since the **First Lieutenant** rank doesn't allow your plane to crash, use this level to practice your landing skills. At upper ranks, being able to shoot up things is only part of being a "complete" pilot.

Setting up the Landing

Half the process is getting your plane into approach position. You're going to land on **Runway # 9** approaching from the west. It's important that you give yourself plenty of airspace for the approach.

- If it isn't already on, switch to **Map** mode on the **COMED** screen ("**C**" key).
- Fly to the position indicated in the diagram below and turn to a **heading of 90 degrees** at an **altitude of 37,000 ft.**

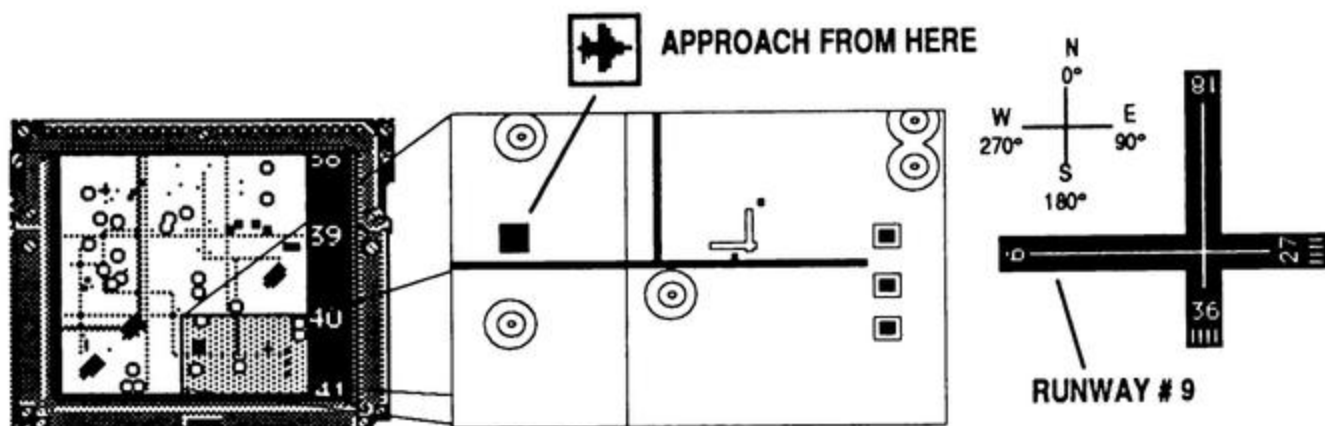

- Reduce your speed by **throttling down** with the "**-**" (**Minus**) key to about **300 knots**.

The following illustration points out all the important components of your landing (ILS) Head-Up Display, AOA Indexer, and AOA Indicator.

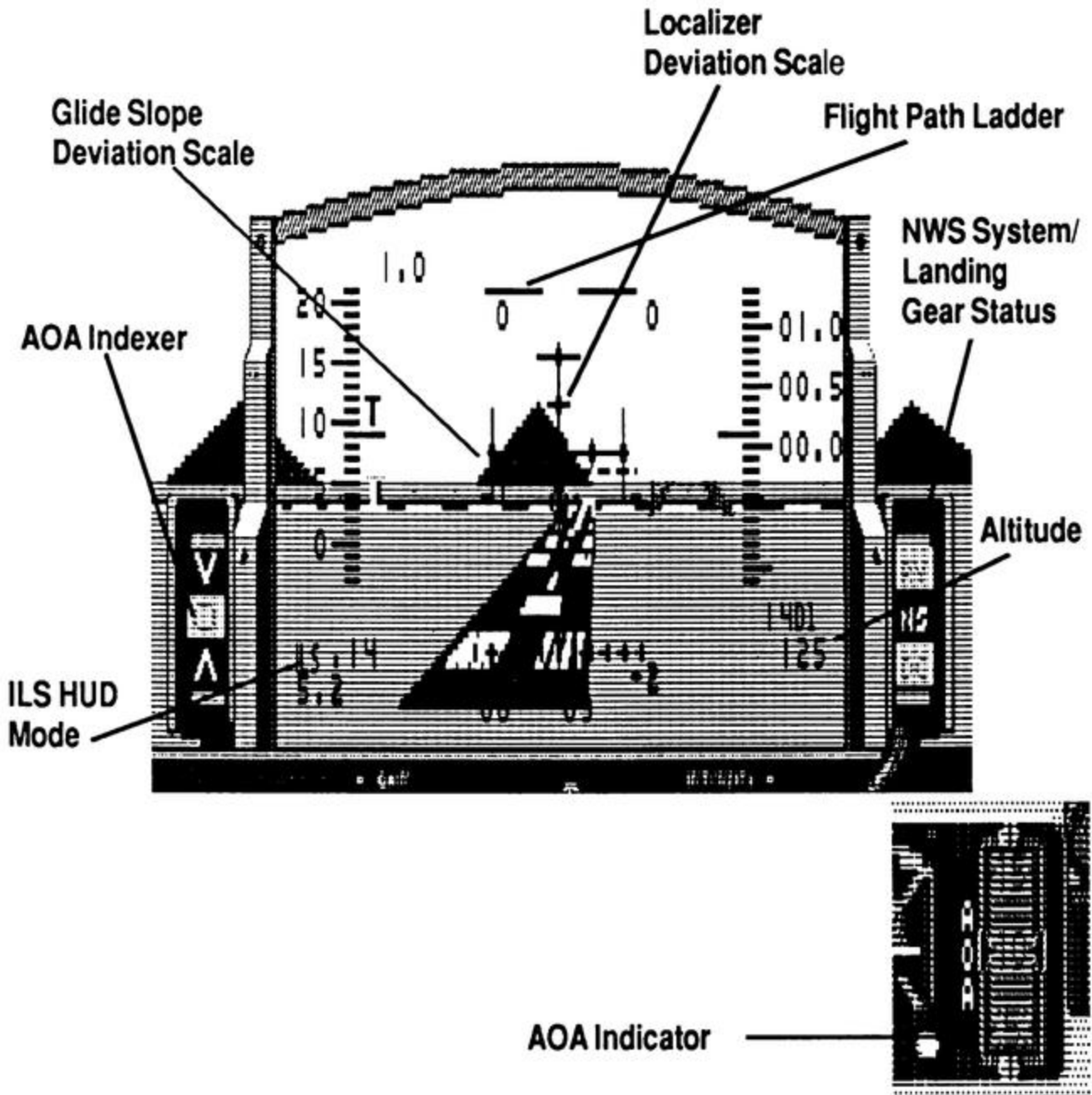

Instrument Landing System (ILS) HUD Mode

- From here you can start a downward approach. Switch on your **Instrument Landing System (ILS) HUD mode** by pressing the F7 key. *We suggest you press the **Pause** key ("P") here and read about the landing procedure before continuing.*

The ILS is designed to assist a pilot in making a smooth landing. The whole idea behind the ILS is that an imaginary beam is projected from the runway. A pilot must "ride down the beam" to make a perfect approach. *Runways have to be specially equipped to handle ILS landings. In FALCON, only Runway #9 is set up to handle ILS landings.*

The ILS Hud has two principal components: the **Glide Slope Deviation (GSD) Scale** and **Localizer Deviation (LD) Scale**. The **LD Scale** displays angle variance between the correct heading approach angle (90 degrees in this case) and the angle between your current position and the runway. The further **you** are to the **right**, the further the **GSD Scale** slides to the **left**, and vice versa.

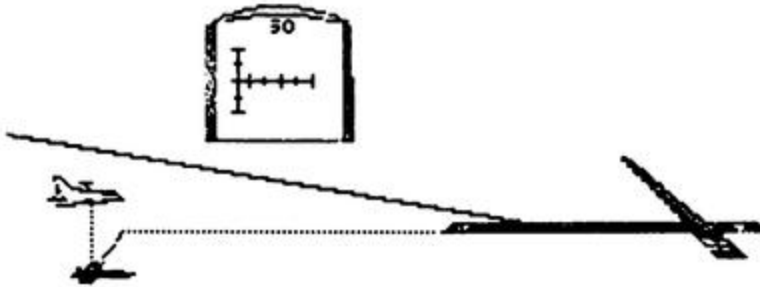

The **Glide Slope Deviation Scale** displays the angle offset between the beam and your intercept angle to the runway. The **higher** above the ILS beam **you** go, the **lower** the **LD Scale** slides down the HUD, and vice versa.

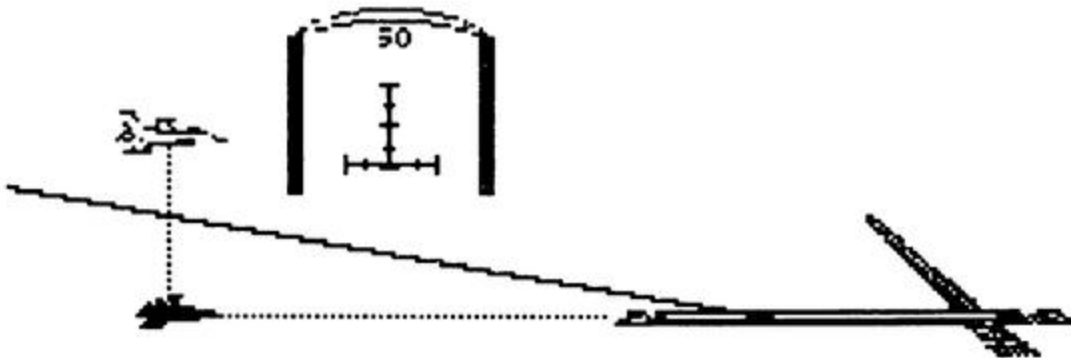

To get in perfect position for landing, steer the plane toward the LD and GSD scales. (This is called "following the needle.") If you are too high, the GSD scale will be below the center of the HUD. You should decrease your altitude until the GSD scale is in the center of the HUD.

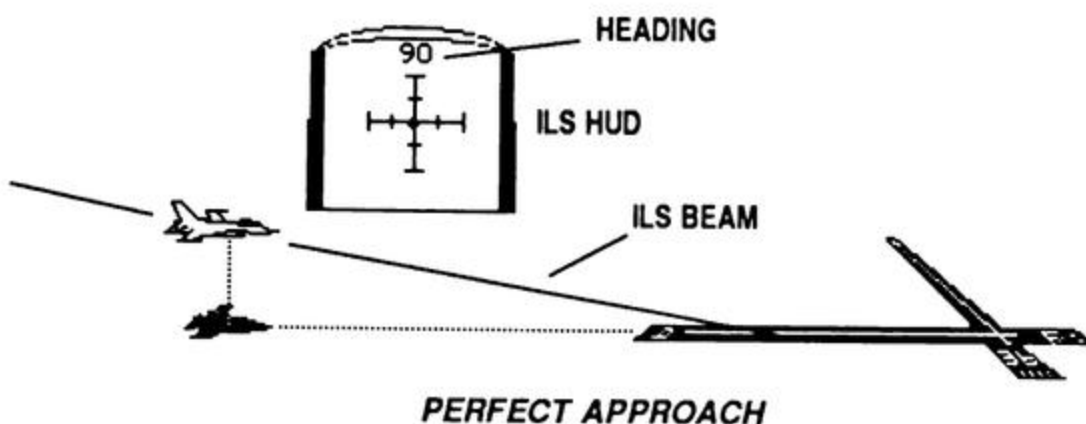

If you are too far left of the runway, the LD scale will be to the right of the HUD's center. Bank your plane to the right so that the LD scale is in the center.

A perfect approach angle will show the GSD and LD coming together so that the middle of each scale crosses at the center point of the HUD to form a perfect cross.

It's important to understand that your *heading* has nothing to do with where the GSD and LD are placed on the HUD. The ILS only checks for deviation between the current intercept of the aircraft with required approach angle. *That's why you still need to monitor the heading scale during landing.* The next example shows a pilot who failed to monitor his heading. For a brief moment, the ILS appeared to be perfectly aligned, because the current aircraft position just happened to cross the ILS at the correct point. Notice how everything is aligned in the HUD, yet the heading is incorrect.

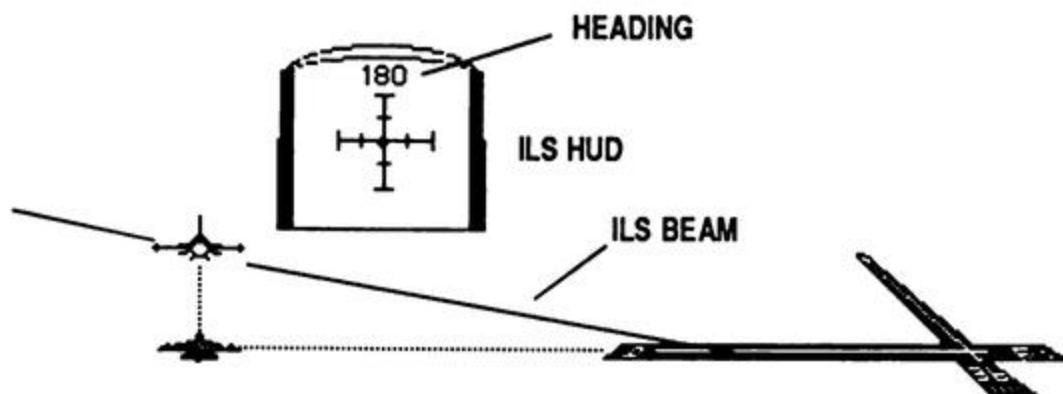

INCORRECT HEADING, YET SEEMS TO BE PERFECT INTERSECTION WITH ILS BEAM

- Continue your downward approach, making sure that the GSD and LD are kept in alignment. Use small movements to make course and altitude correction. *Don't over-compensate.* Once you've fallen below 5,000ft, throttle back to about 68% RPM and reduce your airspeed to 125-150 knots. Use the Air Brakes ("B" key) to help you decrease speed. *However, make sure your airspeed doesn't fall below 100 knots. At higher ranks, falling below 100 knots can result in a stall, followed by a funeral.*

At upper ranks, a correct Angle of Attack (AOA) is extremely important to the success of your landing. A plane's AOA should lie between 8 and 13 degrees (on the AOA Indicator). *Dropping airspeed will increase your AOA.* Take a look at your AOA Indexer on the left side of the HUD. If the top light is on, then you are coming in too steep and too slow. If the bottom light is on, then your airspeed is too fast and AOA is too shallow. A center light indicates that your airspeed and AOA are perfect. (You'll learn more later on AOA.)

- When you get below 4,000ft, drop your **Landing Gear** by pressing the "G" key. Your **NWS System/Landing Gear Status Indicator "RY"** (ready) light should be illuminated (just like it was before raising the gear earlier upon takeoff). *Check the **Left View** to make sure all three wheel lights are lit.* If not, you better prepare for a crash landing (remember, upper ranks only). Here's a typical view at 125 ft:

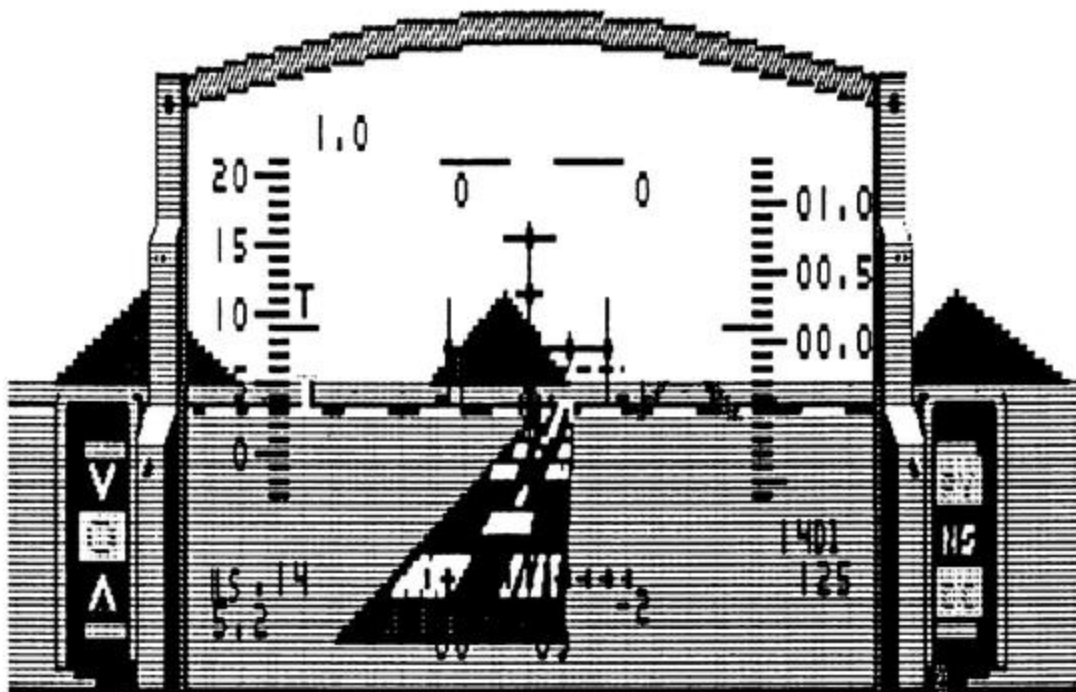

- At this point, it's important that you monitor your **altitude, airspeed, GSD, and LD**. Use **throttle and air brakes** to adjust your speed. **If you're going too slow, turn off your air brakes and increase throttle, or drop your nose a little.** (*Don't get in the habit of dropping below 8 degrees AOA.*) Use **Trim Control (Alternate key in conjunction with "stick" control)** to make small adjustments in your climb angle and bank. *Right before touching down (altitude under 100 ft), make sure that your climb angle (Flight Path Ladder, remember) is not less than -8 degrees.* Note that the trim control key is a toggle key.
- As soon as you touch down, **reduce throttle to less than 60% RPM, and apply Air Brakes, Flaps ("F" key), and Wheel Brakes** until you come to a complete stop. At this point, you may exit to an option menu by pressing the "Esc" key. Select "**END MISSION**" to collect any ribbons and merits that are due you. Click the mouse button on the Mission Results screen to see the Sierra Hotel display. Congratulations!

After a little practice, you'll get the hang of flying your F-16 as well as firing at the practice buildings in the **Milk Run**. Click on the Sierra Hotel screen to get back to the duty roster.

You can take different approaches from here to experience more of **FALCON** and progress in skill. Continue to perform the **Milk Run** (or just fly around) at higher ranks to become adept at controlling an F-16 with more realistic handling characteristics, or try some of the other missions while remaining as a **First Lieutenant**.

Use the **First Lieutenant** level as a "training simulator" to learn air combat maneuvers that can "make or break" your ability to survive dogfights at higher ranks. You can invoke a "Black Box" flight recorder that will replay flight sequences for you to analyze, if you have a 1MB system. See the chapter "Air Combat Maneuvers."

Enemy Planes and Missiles

The enemy has two ways to battle against you in **FALCON**. One is with the **MiG** jet fighter; the other is via the Surface-to-Air Missile (**SAM**).

You can encounter the MiGs in a couple of different ways: **Black Bandit** is a specific MiG mission where you encounter the plane simply by flying north from your airfield. *You will also have the chance of seeing enemy planes at any time after you cross into enemy territory, no matter what the mission is.* Look at the **FALCON** landscape map on page 100 or on the quick reference card to see where enemy territory lies. Fly at **First Lieutenant** level until you get familiar with how the MiG performs, because you can't be shot down by the MiG at this rank.

SAMs can be fired at you in two ways: from a specific "SAM site" on the ground (that you can identify from the air) or via a "shoulder launcher." *Note that you have to fly at **Captain rank (or above)** to have SAMs be active. However, your F-16 doesn't handle much differently at this rank, and although either SAM type can be launched at Captain level, they can't shoot you down.*

On the next few pages, we'll give you an idea of what a typical MiG encounter would be like, and how to down the enemy plane. Afterwards, we'll do the same for the SAMs. To be truly effective against either MiGs or SAMs, you need to become familiar with all the F-16's characteristics and features in **Part II**. Study the differences in rank and mission guidelines in **Part III** to see how and where events will tend to occur. **Part IV** goes over advanced knowledge that will help you be a success in battle over the long run.

F16 Wingman

You will find that there is another F16 flying in the air. When you select a waypoint, he will fly towards it and then circle around the area. Use him to practice formation flying. He will appear on your radar. Do not waste your munitions in trying to shoot him down, you will find he has an uncanny skill at evasion. But if you do succeed you will be busted.

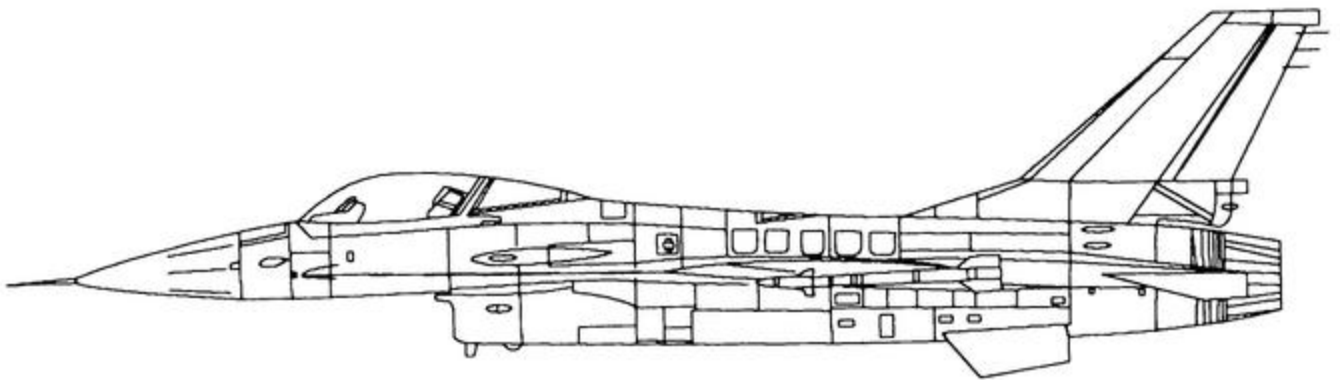

Encountering the Enemy

These examples are intended to give you an overview of the process involved in encountering the enemy's arsenal. Details of your F-16's features used in these examples are covered in **Part II**. Try the different HUD modes while you're in the air. If you want a description of a heretofore unfamiliar feature that begins to appear or operate during the process, simply press the **Pause ("P")** key and read about it in **Part II**. (Specifications for the enemy's MiG-21 jet fighters are on page 135.) *Just like the procedures involved in the previous orientation and flight, everything will become second nature to you after awhile.*

MiGs

If there are any MiGs in the area, you'll usually know fairly quick because a square blip (one per MiG) will show up on your **Threat Indicator** (if the MiG's radar is turned on). Also, if your **COMED** screen is in **Radar** mode and a MiG is in front of you, the data displayed on Radar will give specifics on one "**targeted**" MiG's position, its airspeed, and whether you are either overtaking it, being left behind, or if it's coming straight at you. When in "boresight scan mode" (like looking down the barrel of a gun), the position of the MiG is displayed relative to the nose of Falcon. The distance of the target from Falcon is displayed in the upper left corner of the screen. The "targeted" MiG shows up on your Radar screen as a symbol resembling a diamond with vertical bars left and right. **Radar always "targets" the first MiG to appear.** If any additional MiGs show up on Radar, they will appear as square symbols identical to those on the Threat Indicator.

If there's more than one MiG around, you can alternate between which one is "targeted" by pressing the **Air Target Select ("T")** key. The Radar screen displays specific data on whichever MiG is "targeted."

Alternately, you can switch the radar to "search or tracking mode" by pressing the **F6** key. This gives you an "overhead" view of the targeted MiG, in which the Falcon is located at the lower center of the screen. In this mode, the number in the upper left of the screen represents a distance range: 40, 20, or 10 miles. So, if the number is 40, the targeted MiG is within 40 miles, but more than 20 miles away. If the target is getting closer to you, eventually the radar computer will change the range to 20, and then to 10. To switch back to "boresight scan mode," press the **F5**.

When a MiG is behind you, you'll have to rely on the **Threat Indicator** and your own eyes (by looking out the different views) to determine its position. *Radar can't detect anything to the sides or rear of your plane.*

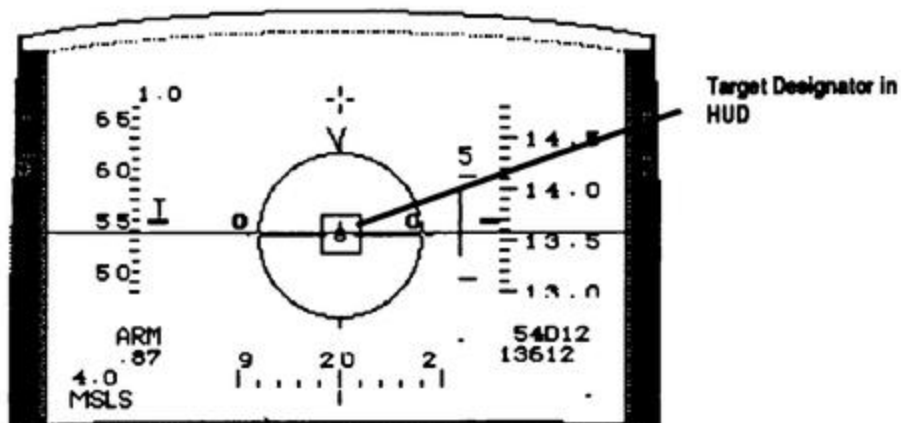

A MiG to the Front and one Behind

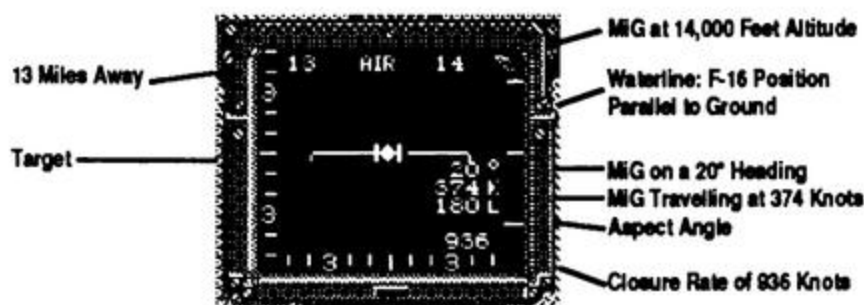

“Boresight” Scan Radar

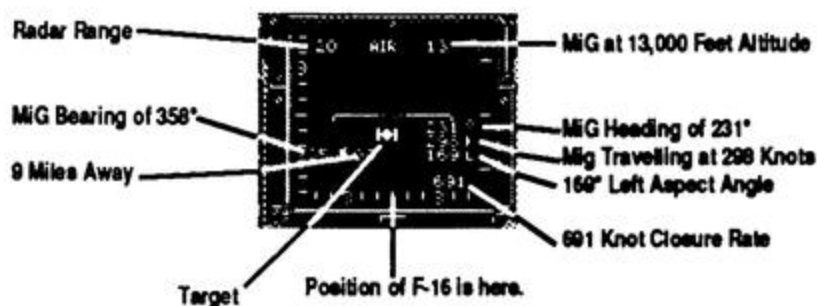
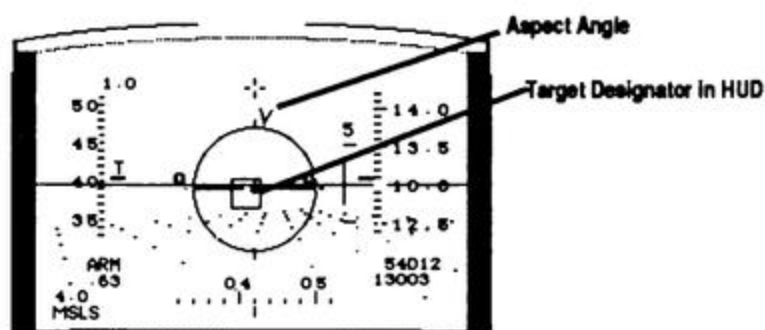

Tracking View Radar (20 mile range)

Whenever possible, you want to maneuver your plane into position behind the MiG (commonly termed "**moving in on his six**", where the nose of the MiG represents 12 o'clock on a clock face and the rear signifies 6 o'clock). It's certainly possible to hit the MiG with a head-on shot using well aimed AIM-9L's or gun bullets, *but the law of averages favors the rear approach*. When the MiG is in front of your plane but out of visual range, the **Target Designator** box will map the MiG's position onto the HUD. *Continue to turn and maneuver the F-16 until you're in a favorable position relative to the MiG.*

Improving Missile Hit Rate

Use the later model **AIM-9L** "All Aspect" Missile whenever possible. This model has three advantages over the older **AIM-9J**. *First, the AIM-9L can track an enemy plane regardless of the direction the target is facing. The AIM-9J requires that you fire at the rear of the target to provide an adequate heat source to track on. Second, the AIM-9L is less susceptible to being fooled by enemy flares. Third, the AIM-9L is more lethal.*

Don't fire missiles if you're too close to the target. (In fact, an "X"—called the *Break X*—appears over the aiming reticle when you're too close for missiles.) An ideal minimum distance is two-thirds of a mile. Switch to the M-61 Gun when in tight, because anything closer than two-thirds of a mile may result in a miss from the Sidewinders. One cause would be the angular velocity of the plane relative to yours is too great and the missile is unable to turn fast enough. The other cause is that by the time the missile starts tracking, its target is out of position. The best way to track the enemy is to use the Aspect Angle Indicator on the HUD.

Aspect Angle

Use the Aspect Angle Indicator to help you move in on the enemy's six.

Aspect Angle represents the MiG's current **heading** relative to your current **position**. To calculate aspect angle, draw an imaginary line from FALCON's current position to the target's current position. (This is called the "position line.") Then draw another line through the target's longitudinal axis (that is, a line that matches the target's heading). The aspect angle is the intersection of these two lines. Note that in the following illustration the aspect angle is 0° in all three examples. (The position line and the heading line coincide. If the MiGs were heading directly toward the FALCON, rather than heading away, the aspect angle would be 180°.)

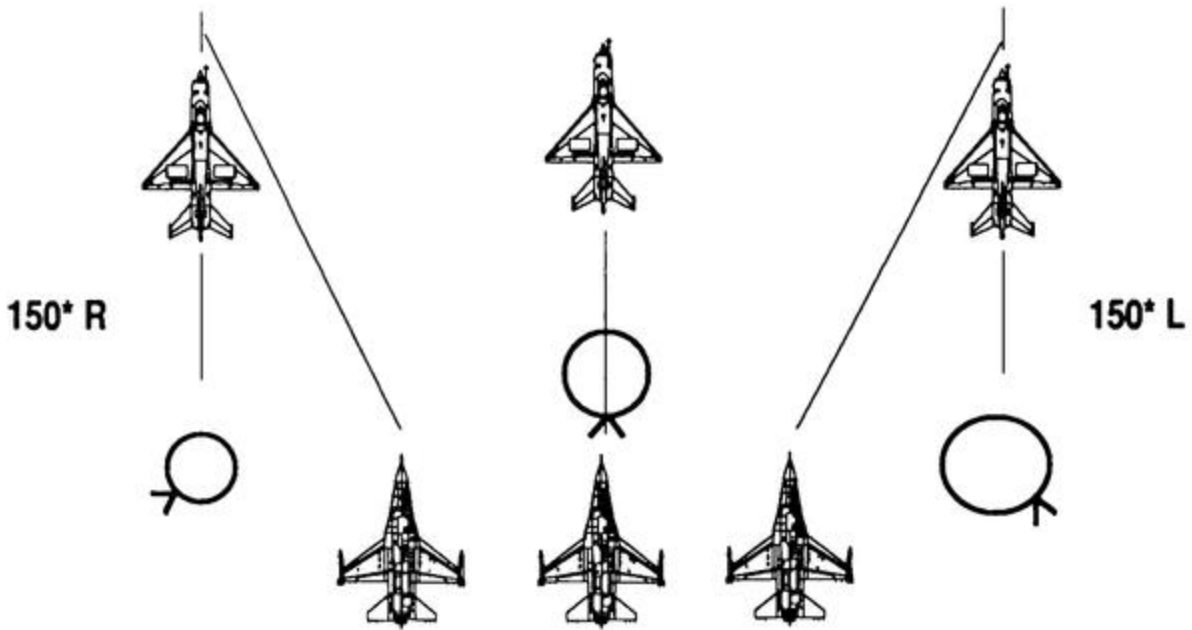
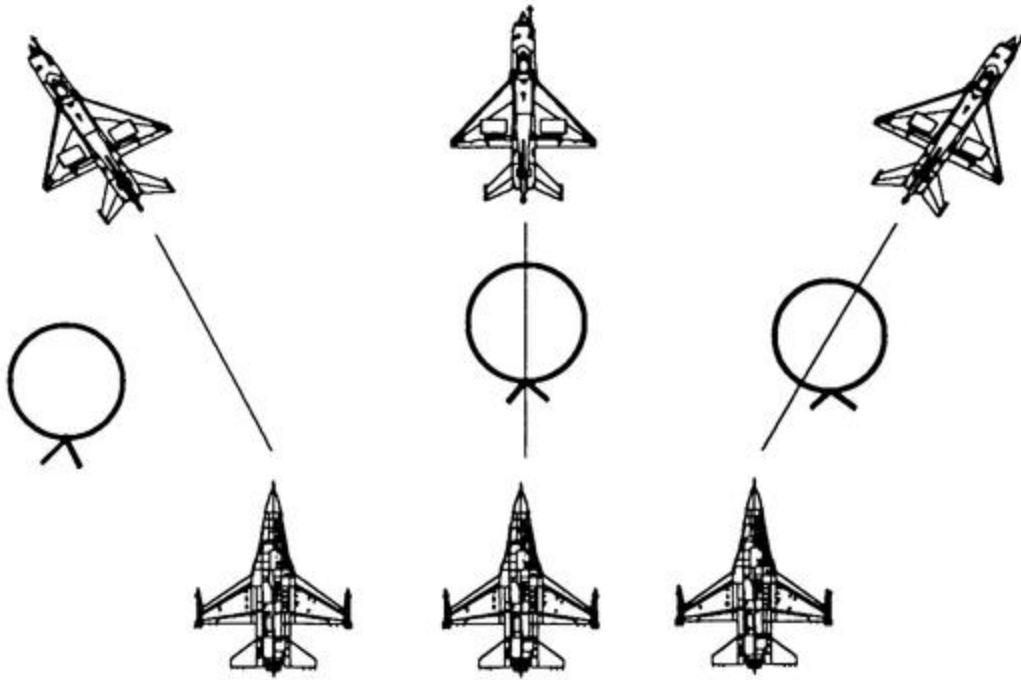

In this illustration, only the center example has an aspect angle of 0° , because the MiG's heading relative to FALCON is different in each case.

Perhaps an easier way to think about aspect angle is visually. The little caret symbol represents the nose of the target. When you look out the FALCON's cockpit, the nose of the actual MiG would be pointed in exactly the same direction as the aspect angle caret in the HUD.

The idea is to keep the aspect angle as close to the target's six (that is, 0°), while you get close enough for your Sidewinder to lock onto the MiG's heat source. When you have a lock and are within a range of about 2 miles, launch the missile and watch it go after the MiG.

In the following example, everything is looking good except for one thing: the Aspect Angle is 180° . The MiG is coming directly toward the FALCON. So even though the missile is locked onto a heat source, and you are in range, chances of a successful hit are slim because the MiG can easily maneuver out of position.

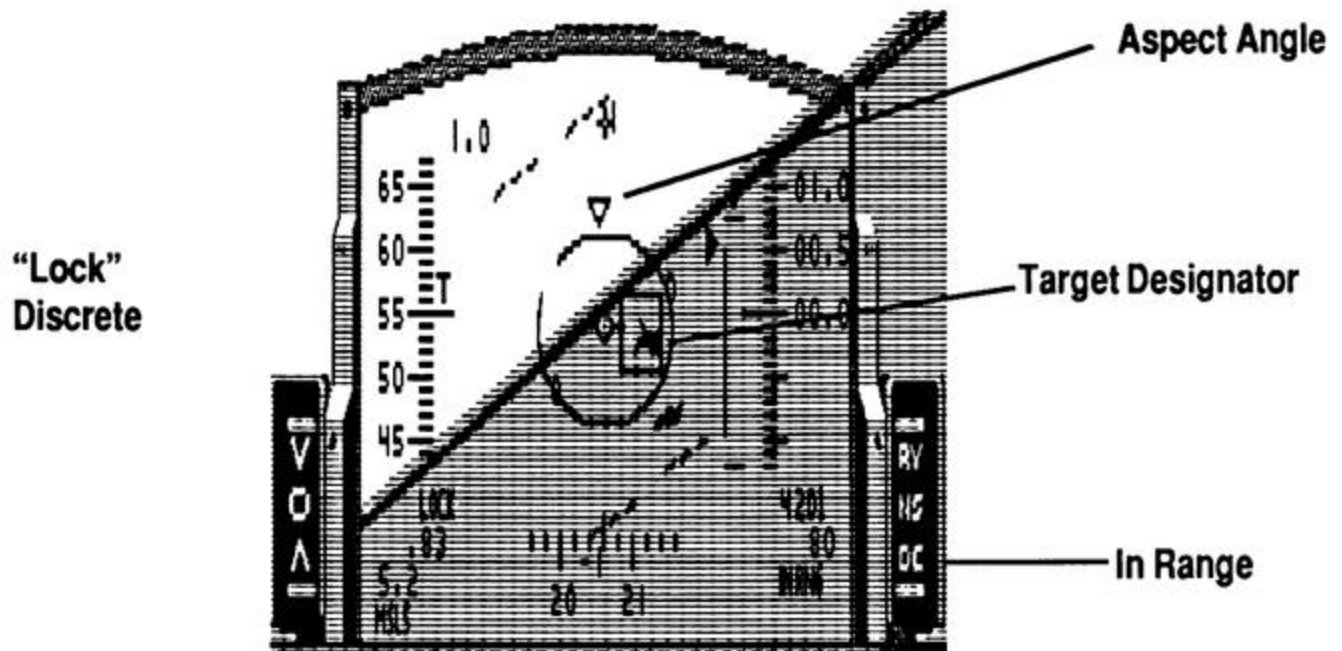

Here, the Aspect Angle is around 10° (7 o'clock), and the missile has a much greater chance of tracking the target. In fact, it was so successful that the MiG has exploded into a fireball.

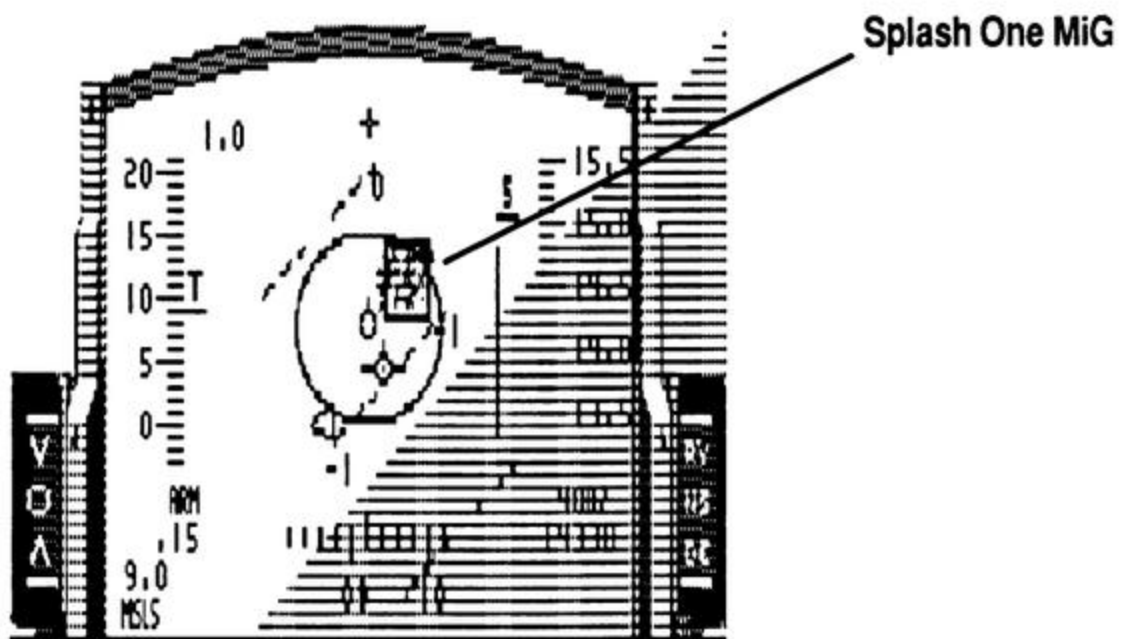

If you get too close to the target before you launch, the Sidewinder might not have enough time to get a good lock. For this reason, the targeting computer will display an "X" (called the "Break-X") across the center of the HUD.

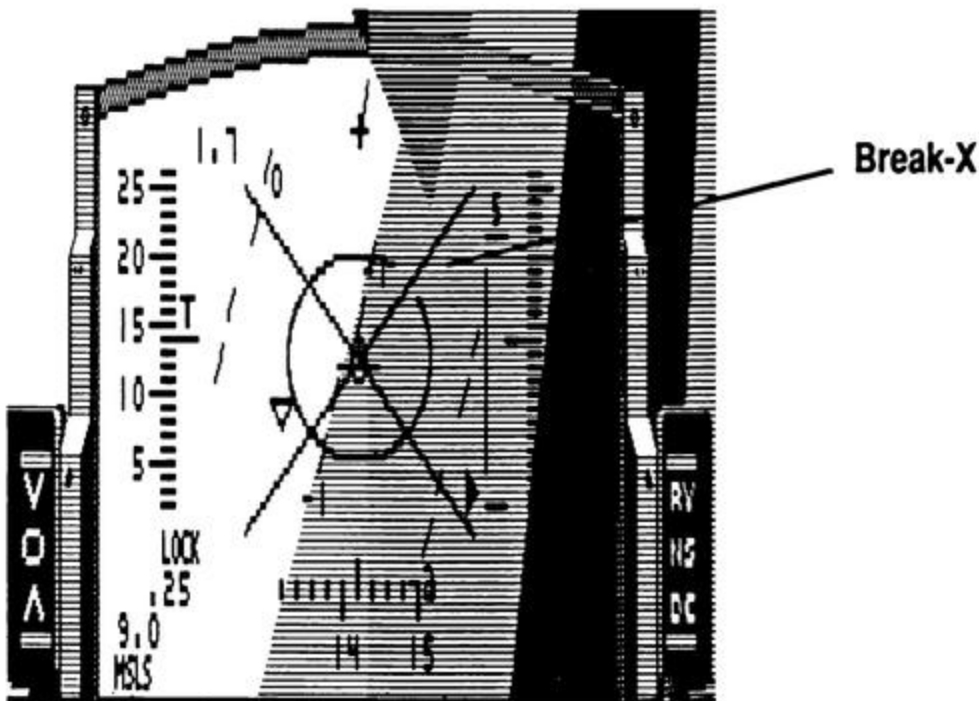

Avoiding MiGs

If you don't want to have enemy planes appear at all during the simulation, you can always specify "zero MiGs" during the opening setup. However, you'll probably want to have MiGs involved most of the time. Beyond enemy lines or at any time after an initial enemy plane has appeared, *more will continue to appear (even after you shoot down the first one) if the conditions are especially "ripe" for them to show up.* The likelihood for MiGs to appear increases dramatically if (1) **you are flying beyond enemy lines**; (2) **your Radar display is turned "on"** (default mode is "on"; turn "off" with the "R" key) and they can detect your radar emissions; (3) **you have an ALQ-131 ECM Pod installed and "emitting"**; and/or (4) **you are flying at high altitudes.** (*In reality, you have to fly below 500 feet to defeat enemy radar!*) Obviously, if you want to keep fighting MiGs (even after your basic mission requirements have been accomplished), you can do so. However, once you're ready to return home and land your plane, you don't want to have to keep fending off the enemy! Therefore, once you've completed your missions requirements (or at any other time), turn off Radar and ECM, fly low (Watch out for the mountains!), and make a hasty retreat for home. You may still have to deal with the occasional persistent MiG, but the chances of that happening will be much lower than before.

Generally get in the habit of flying low and fast with your radar off to avoid MiGs as well as SA-2 and SA-6 missiles from SAM sites.

It follows from the above paragraphs that if you want to avoid MiGs during the Milk Run mission, don't fly into enemy territory.

SAMs and MiGs will never appear at the same time. The enemy doesn't want to shoot down their own planes!

Surface-to-Air Missiles (SAMs)

If you take a look at the FALCON landscape map, you'll notice quite a few locations in enemy territory that are set up for firing **Surface-to-Air Missiles (SAMs)** at your F-16. SAMs are used primarily for defending ground strongholds from air incursions. They can be fired at you in two ways: from a specific "SAM site" on the ground (that you can identify from the air) or via a shoulder launcher.

Ask any pilots who flew in Vietnam or the Middle East about SAMs and they'll tell you that nothing is as scary as the sight of a SAM launching off its pad, leveling off, and heading at Mach 3 directly toward your plane. A SAM launch has been described as watching a telephone pole explode from the ground with fire coming out its rear.

SA-2 Guideline Missile

Guidance:	Radar	Max Speed:	Mach 3+
Range:	31 Miles	Service Ceiling:	70,000+ ft

The SA-2 was put into production in 1956 and designed to intercept high flying, bomb-laden aircraft. This missile system is the most widely used in the world. SA-2's have limited effectiveness against swift and maneuverable aircraft. The **ALQ-131 ECM Jamming Pod** will jam the guidance system of the SA-2's, making them virtually useless. Using **Chaff** is another good way to spoof an SA-2. *These missiles are always launched from SAM sites.*

SA-6 Gainful Missile

Guidance:	Radar	Max Speed:	Mach 2.8
Range:	20-37 Miles (depending on altitude)	Service Ceiling:	50,000+ ft

The SA-6 made its introduction in 1967. Before the ALQ-131 was placed into operation, this missile could destroy its targets regardless of ECM or maneuvering. The jamming pod usually will do a good job against the SA-6. **Chaff** is minimally effective, but that's better than nothing. *This missile (like the SA-2) is launched from SAM sites only, and is all too effective against aircraft flying at medium altitudes.*

SA-7 Grail Missile

Guidance:	Heat-Seeking	Max Speed:	Mach 1.5
Range:	6-7 Miles	Service Ceiling:	4,921 ft

The SA-7 is a shoulder launch heat-seeking missile. These missiles were designed to be used against low-flying targets. The published service ceiling of the Grail is 4,921ft, but a Hunter in 1974 was hit at 11,500ft. The missile is not considered very lethal. Over half the A-4 Skyhawks in the Yom Kippur War that were hit by SA-7's returned to base. *On the other hand, half of them didn't.*

*Since any foot soldier can fire an SA-7, these missiles needn't be launched from a SAM site, so you can't see the ground locations where they come from. **The best defense against an SA-7 is to fly above 10,000ft. A combination of flares and high speed is also very effective.***

Avoiding SAMs

Intelligence has done a good job of identifying (on the landscape map) the locations of all known SAM sites, where SA-2's and SA-6's are fired from. *Foot soldiers are always on the move, so you won't know an SA-7 is in the area until it's launched and you see the launch light (LNH) appear on your Threat Warning System.*

SA-2 and SA-6

Carrying the **ALQ-131 ECM (Electronic Countermeasures) Jamming Pod** can greatly improve your chances against these SAMs. *When activated and "emitting", the ALQ-131 completely jams SA-2 missiles to the point where they don't even launch.* The enemy may still launch an SA-6 in an attempt to burn through the jamming.

The only downside of using the ALQ-131 is that it broadcasts to the enemy that you're around. Expect to see some MiGs appear in the near future.

Since SA-2 and SA-6 missiles are radar-guided, your Threat Warning System will pick up the specific site that launches one and display it as a small blip on the Threat Indicator at its location to your plane. (The site itself projects the radar beam that the missile follows.) This blip is smaller than the one that represents an enemy plane.

If you don't have an ALQ-131 pod, chaff combined with hard maneuvering can defeat the SAM.

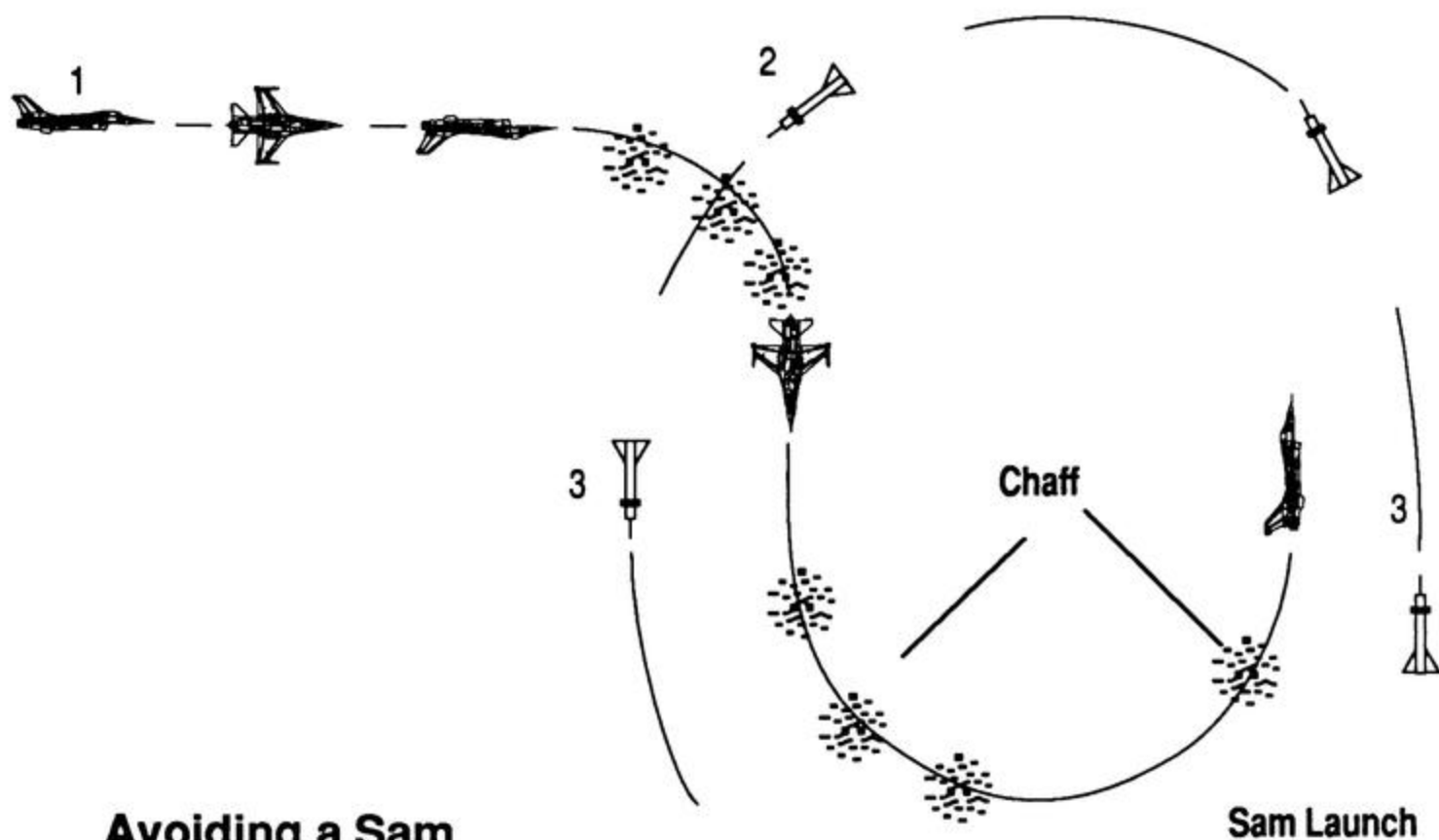

Avoiding a Sam

The first thing you must do during a SAM launch is visually spot the launch. Remember, look for an airborne object that resembles a telephone pole with flames coming out the rear, as it leaves the SAM site. Turn your plane toward the missile. Wait for the missile to begin leveling off. *At this point, roll your plane upside down and pull several g's into a dive.* Head directly toward the ground. At the same time, start releasing **chaff**. Continue to dive for several seconds or until the SAM starts to dive. (You may have to look out the side or rear views to relocate the missile.) At this point, release some more chaff and pull back hard on the stick. **Kick in the Afterburner and start a steep climb.** *Because of the small fins that maneuver a SAM and its great speed, it can't turn with an F-16, and will eventually run out of gas.*

Another way to avoid SA-2's and SA-6's is to fly low and close to the ground. However, doing so makes you vulnerable to SA-7 launches.

SA-7

Since these missiles are shoulder-launched, there's no SAM site to identify. The SA-7 looks like a smaller version of the SA-2 or SA-6 when it's in the air. They're not as lethal as the other SAMs, but they *can* shoot you down. Flying fast and launching flares are a secondary defense against the SA-7. The *best* defense is to fly high (above 10,000 feet), beyond the SA-7's service ceiling.

You can use the same air-to-ground weapons against SAM sites that are used to attack other ground targets.

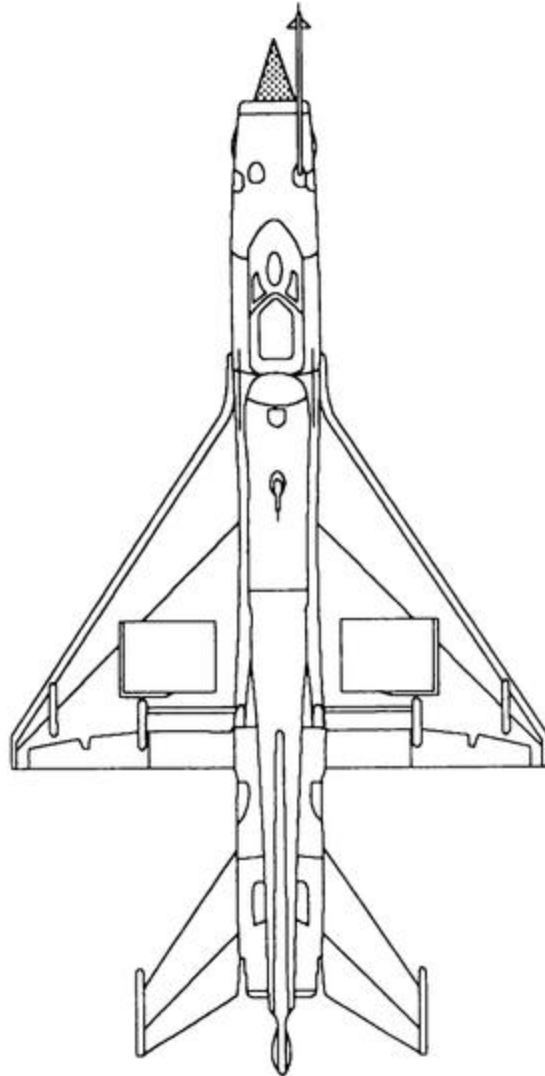



The Ever-Persistent MiG-21

(Refer to pp. 39-42 [Encountering the Enemy], pp. 94-100 [Missions], and dealing with MiGs in general)

- If you don't want to have enemy planes (MiGs) appear at all during the simulation, you can always specify "zero MiGs" during the initial configuration. However, most of the time you'll want to have MiGs involved in the simulation. Beyond enemy lines or at any time after an initial MiG has arrived, MiGs may continue to appear (even after you shoot down the first one) if the conditions are especially "ripe" for them to show up. The likelihood for MiGs to appear increases dramatically if (1) you are flying beyond enemy lines; (2) your Radar display is turned "on" (default mode is "on"; turn it "off" with the "R" key) and they can detect your radar emissions; (3) you have an ALQ-131 ECM Pod installed and "emitting"; and/or (4) you are flying at high altitudes. (In reality, you have to fly below 500 feet to completely defeat enemy radar!) Obviously, if you want to keep fighting MiGs (even after your basic mission requirements have been met), you can do so. However, once you're ready to return home and land your plane, you don't want to have to fend off the enemy while you're doing so. Therefore, once you've completed your missions requirements (or at any other time), turn off Radar and ECM, fly low (Watch out for the mountains!), and make a hasty retreat for home. You may still have to deal with the occasional persistent MiG, but the chances of that happening will be much lower than before.

- Generally get in the habit of flying low and fast with your radar off to avoid MiGs as well as SA-2 and SA-6 missiles from SAM sites.

- It follows from the above paragraphs that if you want to avoid MiGs during the **Milk Run** mission, don't fly into enemy territory.

- SAMs and MiGs will never appear at the same time. The enemy doesn't want to shoot down their own planes!

Also:

When you make hard-turning maneuvers at the upper levels of the program, expect your plane to "bleed off" (decrease) airspeed in the process. This may or may not be a desired effect. If you don't want this to happen, increase RPM to 100% and/or kick in the Afterburner to minimize the effect as much as possible.

Part II: The FALCON Experience: A Guide to the F-16

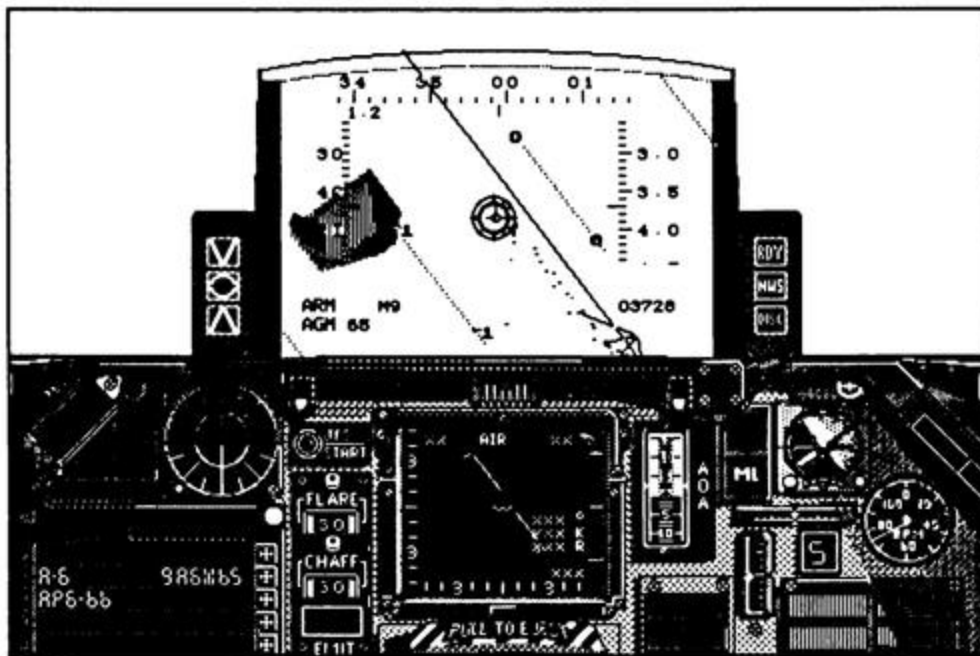

KEYBOARD COMMAND LAYOUT ATARI ST AND AMIGA

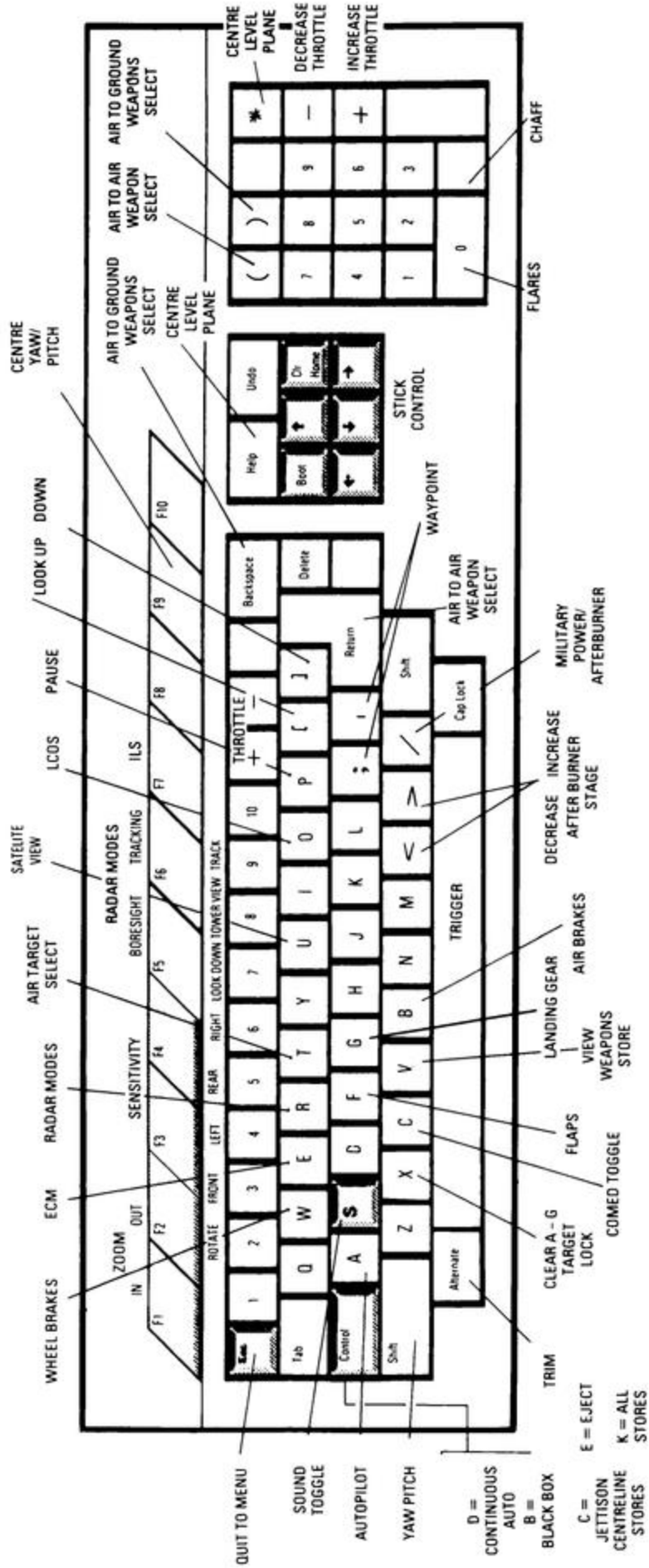

Keyboard Command Descriptions

- ① **COCKPIT VIEWS** - Press any of these keys (**top row number keys only**) to change the view looking out of your cockpit:

- 3- Front
- 4- Left
- 5- Rear
- 6- Right

- ② **OUT-OF-COCKPIT VIEWS** - Use any of these keys (**top row number keys only**) to change to one of the views from outside the cockpit of **FALCON**:

U-Satellite view

8-Tower. This is the view from your airfield's control tower.

9-Tracking. The view from a tracking plane. (Use the **View Rotation** (2) key and the **Zoom** (F1, F2) keys to alter your orientation.)

- ③ **STICK CONTROLS**

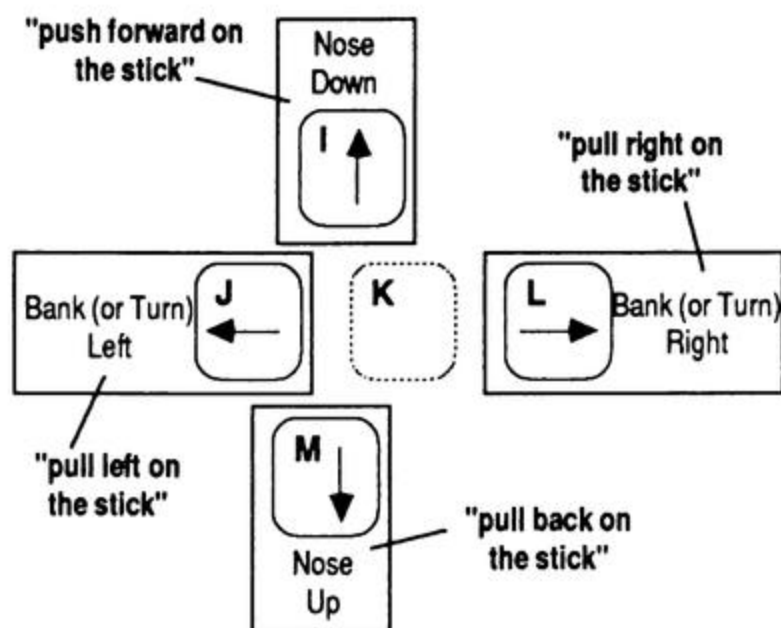

- ④ **THROTTLE** - Press either "+" (**plus**) key to **increase** engine throttle, reflected by an increase in RPM and (normally) airspeed. Press either "-" (**minus**) key to **decrease** throttle and RPM.

- ⑤ **AIR-TO-AIR WEAPONS SELECT** - Pressing the **Return** key once activates the Air-to-Air HUD mode (if not already present). Subsequent taps of the **Return** key toggle through the different missile and gun formats of the Air-to-Air HUD.

- ⑥ **AIR-TO-GROUND WEAPONS SELECT** - Pressing the **Backspace** key once activates the Air-to-Ground HUD mode (if not already present). Subsequent taps of the **Backspace** key toggle through the different missile, bomb, and gun formats of the Air-to-Ground HUD.
- ⑦ **TRIGGER** - The **Space Bar/fire** button is used to fire all weapons and release bombs.
- ⑧ **MILITARY POWER** - The **"/** (**Slash**) key selects 100% standard "MILITARY POWER." It turns off the **AFTERBURNER**.
- ⑨ **AFTERBURNER STAGING** - There are five stages of **AFTERBURNER** (when you need to "put the pedal to the metal!"). **>** increases the afterburner stage; **<** decreases it.
- ⑩ **FLARES** - Press the keypad **0** key to release **FLARES** when *heat-seeking* missiles are being fired at you by enemy **SAM** sites or **MiGs**.
- ⑪ **CHAFF** - Press the keypad key ***** to dispense **CHAFF** and avert *radar-guided* missiles fired at you by enemy **SAM** sites or **MiGs**.
- ⑫ **PAUSE** - Press the **"P"** key to temporarily **PAUSE** the simulation. Press **"P"** again to continue.
- ⑬ **LCOS** - The **"O"** key toggles the **Lead Computing Optical Sight (LCOS)**, a HUD feature used to determine flight direction of enemy **MiGs** when you're aiming guns at them. The default is for **LCOS** to be **"on."**
- ⑭ **AIR BRAKES** - Pressing the **"B"** key activates the **AIR BRAKES**, used to slow your plane while it's in the air (and in conjunction with the **WHEEL BRAKES** upon landing). Pressing the **"B"** key a second time releases the **AIR BRAKES**.
- ⑮ **WHEEL BRAKES** - Apply the **WHEEL BRAKES** with the **"W"** key. Used solely on the ground, these brakes slow the plane upon landing (in conjunction with the **AIR BRAKES**), and prevent the **F-16** from rolling after the engine is started. You can release the **WHEEL BRAKES** by pressing the **"W"** key a second time.
- ⑯ **LANDING GEAR** - The **"G"** key is a toggle for raising and lowering the **LANDING GEAR**.
- ⑰ **VIEW WEAPONS STORES** - Press and hold the **"V"** key to view a list of all the weapons that are presently on your plane.
- ⑱ **FLAPS** - Toggle the **"F"** key to activate (deactivate) your wing flaps for speed control.

- ⑲ **COMED (Combined Map/Electronic Display)** - The "C" key flips this display screen back and forth from a MAP detailing the mission landscape to its default RADAR mode.
- ⑳ **RADAR MODES** - Press the "R" key again to turn off your radar display if you're trying to avoid being detected by enemy planes during play at upper ranks. Pressing the "R" key again switches on. Use F5 for boresight mode, and F6 for tracking mode.
- ㉑ **ZOOM** - Keys F1 and F2 enable you to zoom on the outside or track view.
- ㉒ **AIR TARGET SELECT** - Pressing the "T" key in succession allows you to switch between different enemy planes to aim at, if more than one is in the air at a time.
- ㉓ **ECM** - Pressing the "E" key turns on the **ALQ-131 ECM (Electronic Counter Measures) Pod** (if you're carrying one) as a defense against *radar-guided* SAMs. Press "E" again to shut it off.
- ㉔ **MENU SELECT** - Hit the **Esc** key to bring up the Menu Box. From here you can make various menu choices related to completing or restarting a mission, or you can leave the program entirely.
- ㉕ **DEMO** - During Air-to-Air battle (dogfighting), press the **Control D** key combination after your plane is in the air and the program will take over displaying an intense battle sequence. You still control weapons firing in DEMO mode. Tap the **AUTOPILOT** key ("A") once to exit DEMO mode. All characteristics particular to the current rank apply in DEMO mode, so it's still possible to get shot down at upper ranks, even in the DEMO. You can switch to tracking view, adjust speed and watch a movie of air-to-air combats.
- ㉖ **AUTOPILOT** - If you keep the "A" key pressed during a dogfight, the program's AUTOPILOT mode takes over and tracks the MiG for you automatically. Releasing the A key reverts to normal mode. If there are no MiGs present, the AUTOPILOT will track automatically to the target for the current mission.
- ㉗ **SOUND ON/OFF** - Press the "S" to toggle the program sound on or off.
- ㉘ **CLEAR A-G TARGET LOCK** - During an Air-to-Ground mission, if you make an unacceptable attempt at locking-on to a target, simply press the "X" key to clear the "lock" and try again. At other times, press this key to reset the "max number of g's" discrete on the HUD.
- ㉙ **BLACK BOX** - If you are in a dogfight sequence and want to view an "instant replay" of the sequence so you can analyze the results, press the **Control-B** key sequence to invoke the BLACK BOX.

- 30) **JETTISON CENTERLINE STORES** - You can separately jettison the **ALQ-131 ECM Pod** or any centerline-installed external fuel tank (**Control-C**), if you want added maneuverability or acceleration and need to get rid of excess weight.
- 31) **EJECT** - When all else fails, press the **Control-E** key combination to eject from your plane. Remember that ejection is not necessarily the safest or smartest option to take in a particular situation, and should be invoked only as a last resort.
- 32) **JETTISON ALL STORES** - If you fly into a predicament where you need to add some maneuverability to your plane, press the **Control-K** key combination to jettison everything *except your missiles*. We don't want you to be left *totally* defenseless!
- 33) **LOOK UP LOOK DOWN** - "[" gives a lookup view, "]" gives a look down view.
- 34) **YAW/PITCH CONTROL** - Use **SHIFT** key in combination with the keyboard "**stick control**" directional keys to make fine tuning adjustments in your plane's **PITCH** and **YAW**. This allows the F-16 to point in different directions while travelling in an otherwise straight line. (See p 89 for more info on **YAW/PITCH CONTROL**.)
- 35) **TRIM CONTROL** - Pressing the **ALTERNATE** key toggles Trim Control on and off. When on, the keyboard "**stick control**" directional keys produce a more gradual change in direction when banking left or right, diving, or climbing, than would take place with Trim Control off. The sensitivity number goes yellow when trim is on.
- 36) **CENTER YAW/PITCH** - Pressing the **F9** key with **K** or keypad 5 provides a quick way to bring your F-16's yaw or pitch back in center alignment, rather than making repetitive keypresses with the **Shift** key and the stick control keys.
- 37) **ILS HUD** - Press the **F7** key to activate the **Instrument Landing System (ILS) HUD**, which is a special HUD mode designed just for landing purposes.
- 38) **CENTER/LEVEL PLANE** - Whenever you feel the plane is flying out of control, press the **HELP** key to force the F-16 to resume a straight and level path. This feature is available at any rank.
- 39) **SENSITIVITY** - You can vary the F-16's sensitivity to banking, climbing, or diving turns on a scale from 0-9 with the **F3** (decrease) and **F4** (increase) keys. For example, you might want to start learning how to make bombing runs at "1" (one) sensitivity, but end up progressing to "9" level eventually in aggressive dogfight battle.

- ④⑩ **WAYPOINT SELECT** - ";" increases the **Waypoint** number;" ," decreases the number. Use these commands if you want the autopilot to fly you toward a different mission's target.
- ④⑪ **TOWER VIEW** Press key "8" for a view of the F-16 from the control tower.
- ④⑫ **SATELLITE VIEW** - This view is from a satellite directly above the F-16. Press key **U** to see it.
- ④⑬ **VIEW ROTATION** - When you have selected the **Tracking View (9)**, use key **2** to rotate the view.

The *FALCON* Armament

The F-16 can carry a wide assortment of weapons for different purposes. Following are the ones available in **FALCON** and a diagram of how they are placed onto your plane.

M61-A1 Vulcan Internal Gun

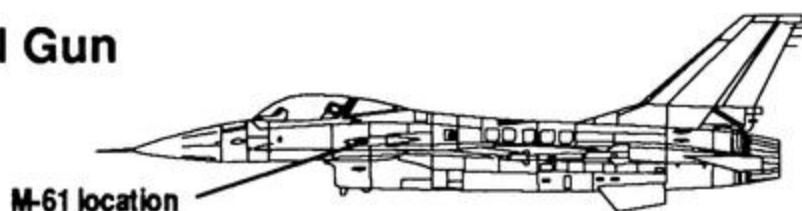

Also called a cannon, we call the M61 a gun because of the information displayed on the HUDs where its status will appear. Since the M-61 is an internal weapon, your F-16 in **FALCON** automatically starts with 5000 rounds of ammunition. The gun may be used in either air-to-ground strafing runs or close air-to-air combat.

AIM-9J Sidewinder Missile



The AIM-9J Sidewinder is a heat-seeking missile used in air-to-air combat, with an average useful range of 5 miles. It is possible for the AIM-9J to hit a plane as far as 11 miles out, but not probable. It needs a strong heat source to track, and should be aimed at the rear quarter of an enemy plane for it to be effective.

AIM-9L Sidewinder All Aspect Missile



The AIM-9L Sidewinder is similar to the the AIM-9J in that it's a heat-seeker for air-to-air combat. However, it's called "all aspect" because it contains filters that screen out extraneous heat sources. Because of this, it's not as easily fooled by enemy flares, and a hit can be made without having to aim directly at the MiG's rear exhaust. The effective range is equal to the AIM-9J.

AGM-65B Maverick Missile



The AGM-65B (pronounced "AIM" 65B) is an optically-guided missile used for air-to-ground missions only. In theory, an AGM-65B can be fired when a target is within 14 miles, but its

effective range is 7-8 miles. Although it can be fired from any altitude, we recommend you fly below 20,000 ft. Since it's optically guided, you need to gain a good sight on the target. Besides, long range SAMs (surface-to-air missiles) will be very happy to see you above 20,000 ft, and you don't want that. You must be diving in order for Maverick to fire.

Mk 84 2000lb Low Drag Bomb



The Mk 84 (pronounced "Mark" 84) is a high quality, general purpose bomb. It is used for any air-to-ground bombing run where you want to make maximum impact. Bombs can be dropped from any altitude, but your accuracy increases dramatically as you fly closer to the ground, since you're relying on visual contact.

Durandal Anti-Runway Bomb



The Durandal is a bomb that's especially destructive to airstrips. Whereas conventional bombs (like the Mk 84) create large craters where they hit, the Durandal drives itself into the airstrip, blowing a hole from under the pavement. This makes repairs much more difficult.

WARNING

Although you want to fly as close as possible to the ground on bombing runs, don't move in below 2,000 feet or your bombs may eliminate you as well.

ALQ-131 ECM Pod



The ALQ-131 pod should be carried (if available) on air-to-ground missions. It is an ECM (Electronic Counter Measure) device that emits signals to jam enemy radar, preventing SAM sites from getting missile lock on your F-16.

Fuel Tanks

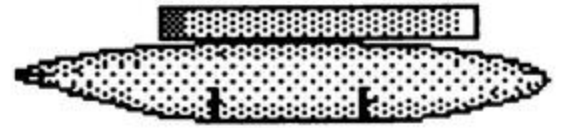

Your F-16 has an automatic internal fuel capacity that averages 6,950 pounds. You can add external 2,304 lb. fuel tanks (up to three) if you wish to have added fuel capacity. Remember that afterburner usage will eat up your fuel quickly, but don't get in the habit of adding so much fuel (instead of armament) that you're flying a fat cow with no protection or maneuverability.

ARMAMENT CONFIGURATION

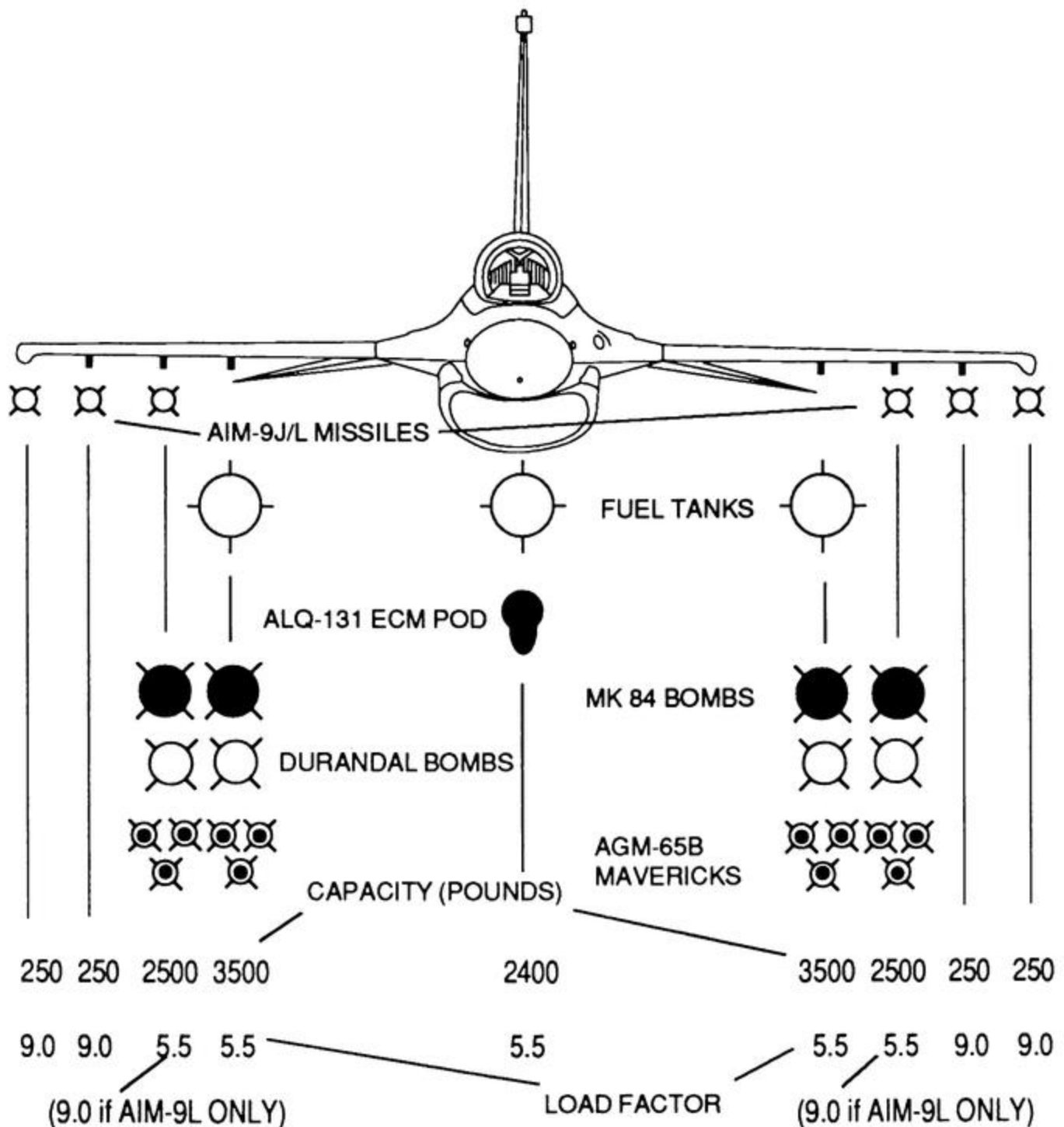

Note the numbers for CAPACITY and LOAD FACTOR. You are shown the total weight of your armament as selections are made via the Sarge. The LOAD FACTOR represents the highest amount of g's that you should pull if weapons are installed on that particular station. At the lower levels of the simulation, you will have few limitations on your armament. However, at upper levels you must adhere to the rules for placing weapons onto the F-16. When you select and load your armament at the beginning of the game, the Sarge will alert you as to what configurations are possible or not. He will also place the weapons on your plane so that you maintain a symmetric (balanced) load.

The FALCON Cockpit (Main Features)

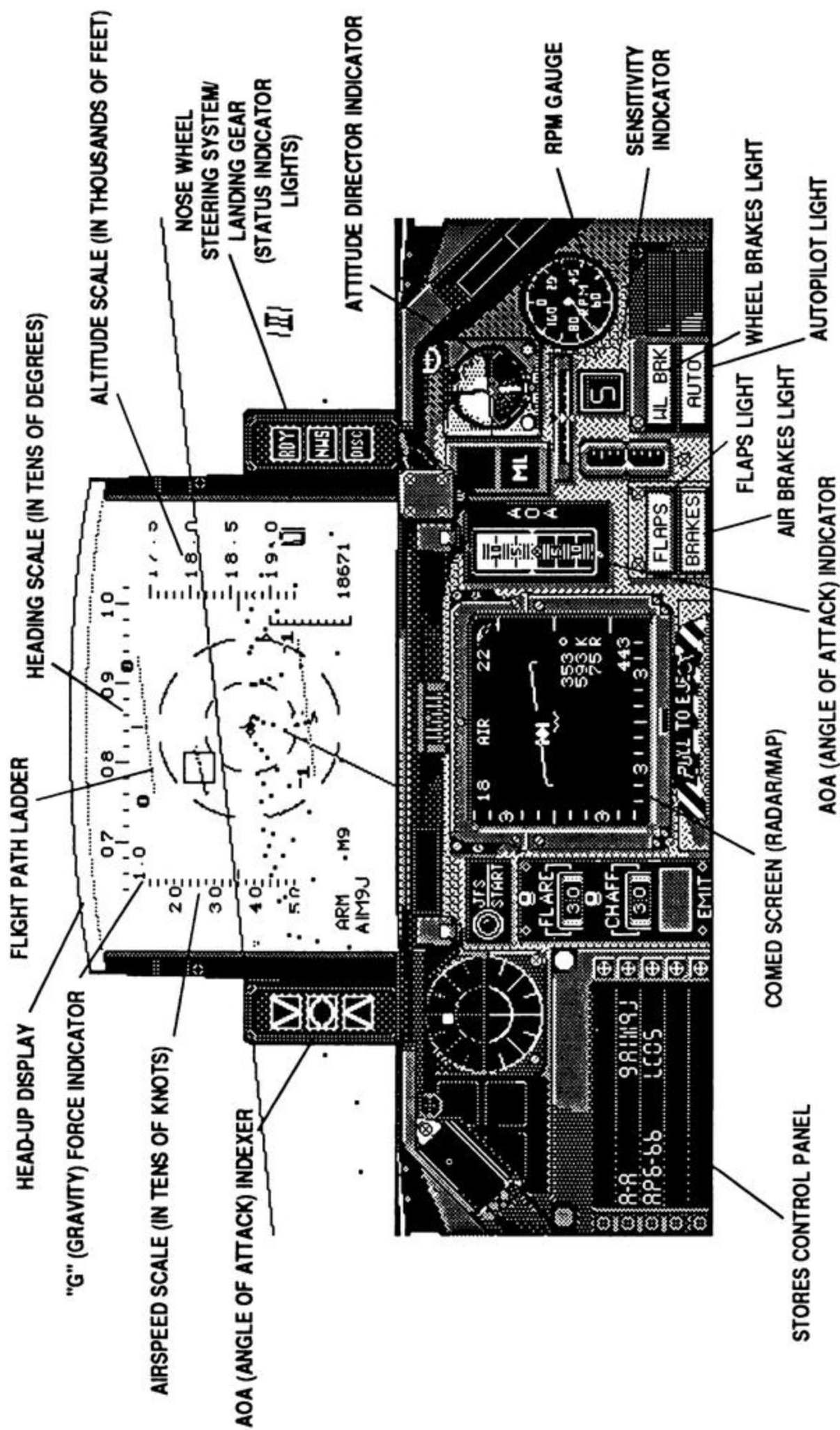

Head-Up Displays

The most prominent item in the F-16 cockpit is the HUD, or Head-Up Display. The HUD is a piece of glass separate from the canopy that displays electronic data on altitude, airspeed, and heading, as well as information specific to weapons usage, such as aiming sights and distance to target. Following is a list of items that exist on every HUD mode, as well as discussion of the specific HUD types and their uses.

Items That Are in Every HUD

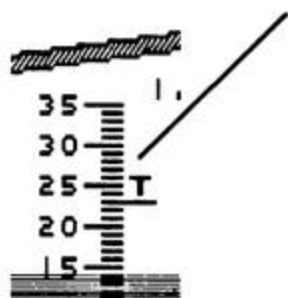

Airspeed Scale

The Airspeed Scale runs up the left side of any HUD mode and displays the F-16's true airspeed in tens of knots. In other words, the number 20 represents 200 knots. The wider hash mark with the "T" over it denotes the current speed at any particular time.

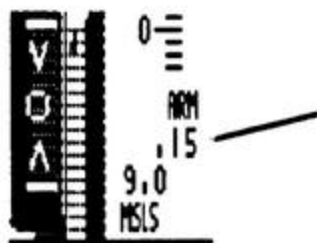

Mach Indicator

The Mach indicator shows the current airspeed as a percent of the speed of sound (which is Mach 1).



Heading Scale

The Heading Scale runs along the top of most HUDs and displays the direction (in tens of degrees) that your F-16 is headed toward. The longer hash mark in the middle of the scale displays the current heading at any time. (In the Air-to-Air HUD, the Heading Scale is at the bottom.)

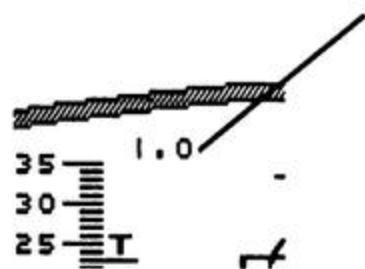

G Force Indicator

Located just above the Airspeed Scale, the G Force Indicator displays the "g" forces (of gravity) that are acting on you and your plane at any time. G forces are discussed in detail in the section "General Flight Performance of the F-16" of your Flight Manual.

Max G Force Indicator



This indicator, located just below and to the left of the Mach Indicator, tells you (and the engineers on the ground) the greatest number of g's you have pulled. Pressing **X** resets this to zero.

Altitude Scale



Located on the right side of every HUD mode, the Altitude Scale displays your plane's altitude in thousands of feet. The wider hash mark in the middle denotes the current altitude at any time. Note how the current altitude is detailed in the lower right corner beneath the Altitude Scale.

Flight Path Ladder

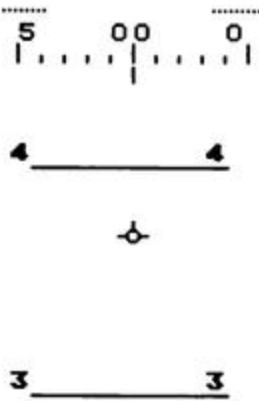

The Flight Path Ladder gives an electronic representation of the F-16's angle of climb (or dive) at any point in time. The numbers go from 0 (straight and level) to 9 (90° climb straight up); or in the opposite direction (with negative numbers representing a dive) to -9 (90° dive straight down). (Also, the lines are solid when climbing; dotted when diving.) For example, the Flight Path Ladder show opposite illustrates a plane in a 38° climb. The figure immediately below is another way of illustrating what the numbers represent.

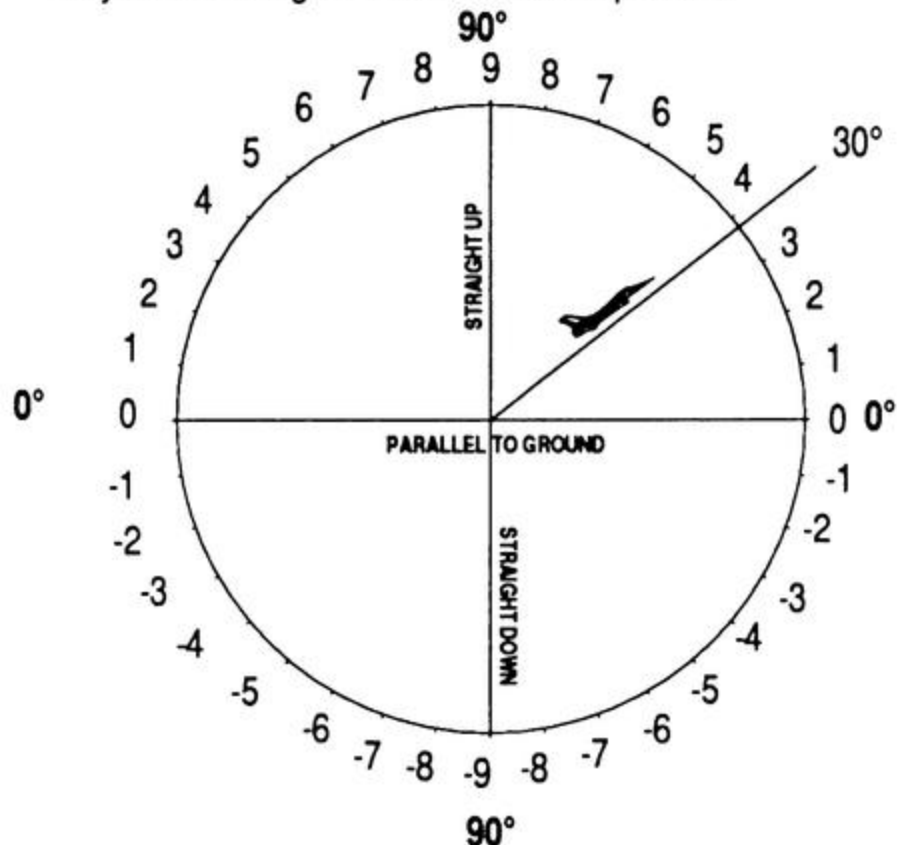

Distance to Target and Waypoint Indicator



Displayed on every HUD just under the Altitude Scale is the Distance to Target and Waypoint Indicator. The first number is your current distance from the target specified in your mission. Following the "D" is a number that corresponds to that target. You may change the Waypoint by pressing "▼" to increase the number, or ";" to decrease the number. (See the Missions chapter for details.)

Velocity Vector

LINE OF FLIGHT

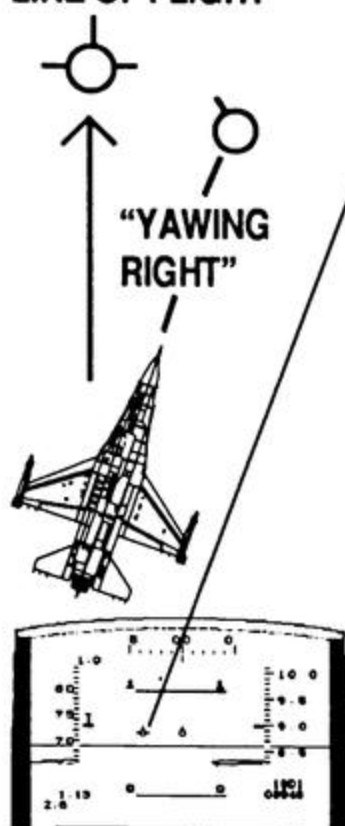

The Velocity Vector represents the degree of yaw and/or pitch that your F-16 is incurring. You have an ability to point the plane to a certain degree in a direction that varies from the general direction that you are travelling. In the opposite example, the F-16 is travelling straight and level, but the plane is pointed slightly to the left. You'll use this feature primarily in bombing runs when you want to aim at a target without having to travel directly toward it.

To point your plane in the manner of this example, you would hold down the **ALTERNATE** key while "pulling the stick right" on the keypad controls. Your plane would point itself to the right while continuing to fly straight ahead. If you wanted to point the plane back to the left (*completely lined up with your flight path again, if you want*), you would hold down the **ALTERNATE** key again and "pull left on the stick." When you perform these actions, you are "yawing right and left."

"Pitching up and down" is the same theory applied to pointing the plane up and down while you fly straight ahead. The only difference is that you "push forward or pull back on the stick" while you hold down the **ALTERNATE** key. For example, if you were going to fire at a ground target at a low altitude, you might need to point ("pitch") the plane downward while you aim, so you wouldn't have to dive any further.

Directional Indicator

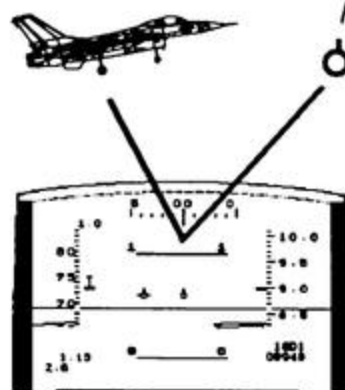

Represents any directional change that you make either in bank or pitch. Primarily designed as an aid for joystick and mouse users to orient themselves while changing direction, this indicator serves as an additional feedback for keyboard and mouse users as well.

Air-to-Air HUDs

To select a particular Air-to-Air HUD mode (AIM-9J Missile, AIM-9L Missile, M61-A1 Gun), tap the Air-to-Air Weapons Select key [Return] until your selection appears in the HUD glass.

Note: HUDs for the AIM-9J and AIM-9L missiles are selected and displayed separately during the simulation since these missiles are operationally and physically different. However, the HUDs are functionally identical, so we'll discuss them together in one section.

Air-to-Air Missile HUD (AIM-9J or AIM-9L)

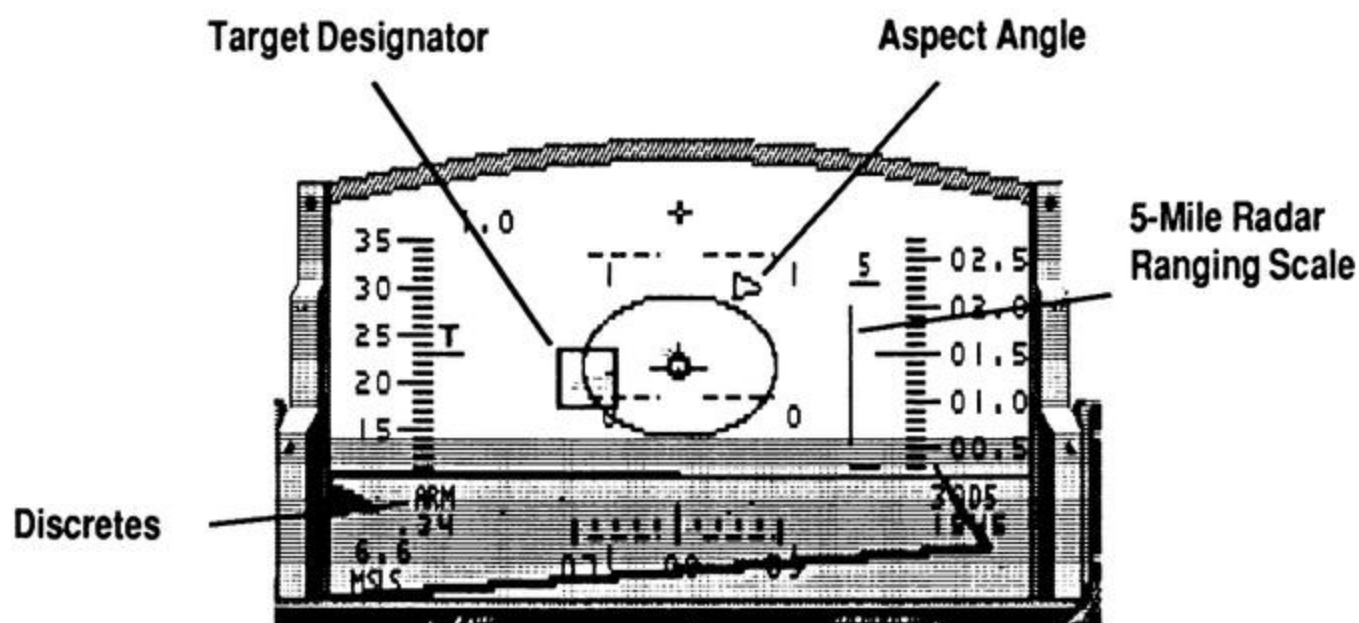

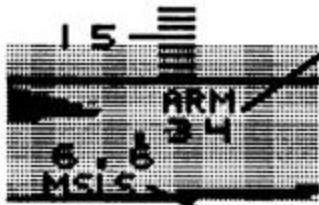

Discrettes

The discrettes on either A-A Missile HUD describe whether or not your missiles are **ARM**ed or **LOCK**ed onto a target. *If no message appears, it means that there is something wrong with the system or that you are out of missiles.*

HUD Mode Indicator

This indicates that missiles have been selected. Look at the Stores Control Panel to see which type of missile is currently selected.

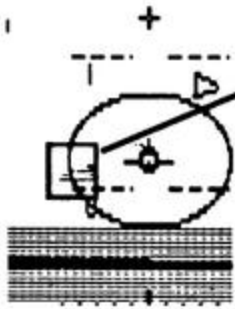

Target Designator

The target designator will follow the target that your radar is tracking. If you are in a multiple-bogey dogfight, use the Target Select key [T] to track another plane. If the Target Designator has a flashing diamond in the middle of it, your missile has locked-on to a heat source.

When the target leaves the HUD, the Target Designator appears with an "X" across it. Look in this direction to find the bogey.

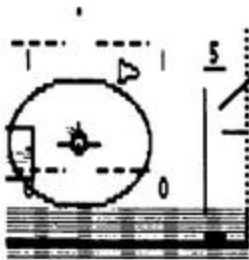

Five-Mile Radar Ranging Scale

The Five-Mile Radar Ranging Scale graphically represents the distance between you and the target you are tracking. Each notch on the scale represents 1 mile. The higher the arrow, the further away from the target.

In Range Indicator

This indicator will light up (**IN RNG**) when the lock-on diamond flashes.



Aiming Reticle

This is a visual aid to help improve your probability of hitting a target. If the target is inside the circle of the reticle, you have

a good chance of hitting the target—assuming that you already have a lock-on (flashing diamond) and the target is in range (check the **In Range Indicator**).

Aspect Angle Indicator

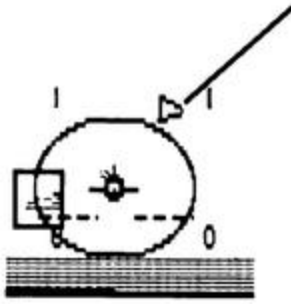

Aspect angle is the angle formed by the intersection of two imaginary lines: the line through the target's longitudinal axis; and the line from the Falcon to the target (the "Position line"). If the MiG is coming at you head on, the aspect angle is 180° , and the aspect angle indicator will be at the top of the aiming reticle (at 12 o'clock). An aspect angle of 0° means you are on the target's six and the aspect angle indicator will be at the bottom of the aiming reticle (at six o'clock). Otherwise, if you're facing the MiG's right side, the aspect angle indicator will be on the right side of the aiming reticle. It's on the left if you're facing the left side of the target. (Note: Aspect angle is determined in relation to Falcon's **position**, not **heading**.)

Target Locator Line

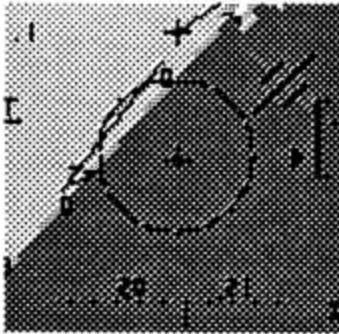

This line points in the general direction of the targeted MiG if it is not visible in the HUD. It is useful when the Target Designator box hasn't yet appeared in the HUD. The line disappears when the Target Designator box appears.

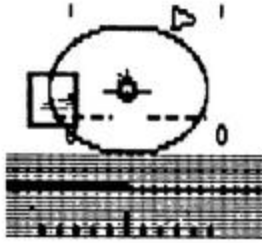

Distance Ranging Scale

A line appears on the outside edge of the Aiming Reticle when a MiG is within 12,000 feet. As the MiG moves closer, the line moves in a counterclockwise direction around the reticle. Each "o'clock" equals 1,000 feet. (Movement of 90° represents 3/4 mile.)

Break X

When you're too close to fire missiles, the Aiming Reticle is overlaid with a large "X."

Air-to-Air Gun HUD (M61-A1)

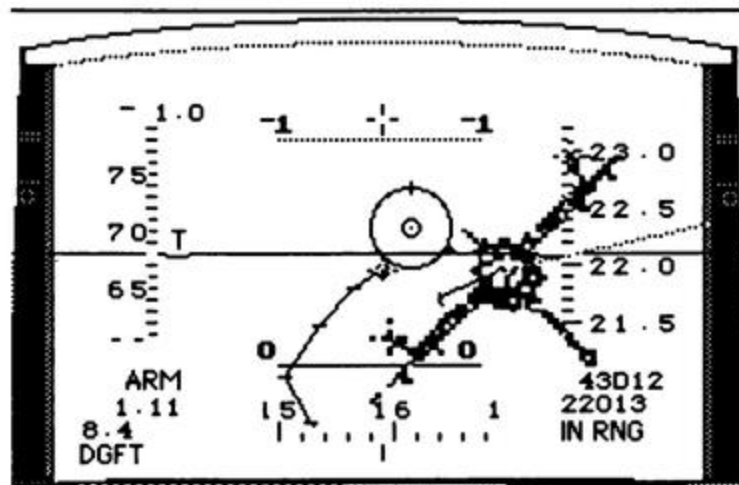

ARM

1.11

8.4

DGFT



Discrettes

The Discrettes on the M61 HUD indicate if the gun is **ARM**ed and ready. If this light doesn't come on, then your gun is either out of ammo or is jammed.

HUD Mode Indicator

DGFT indicates you're in Air-to-Air gun mode.

Target Designator

Indicates the plane your radar is tracking.

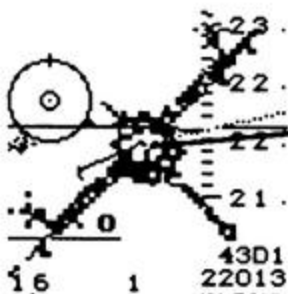

Aiming Reticle



Your F-16 firing control system automatically computes where fired bullets would be by the time they reach target range. The firing control system then plots the Aiming Reticle at the precise place the bullets would land if you fired at that time.

In Range Indicator

Appears (IN RNG) when the target is within 2 miles of you.

LCOS (Lead Computing Optical Sight)

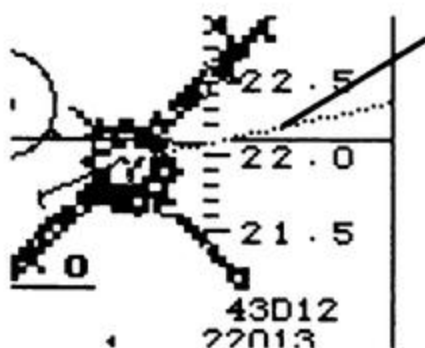

The LCOS line will always appear in conjunction with a target plane (assuming LCOS is "on"). To toggle on the LCOS mode, use the [O] key. LCOS is extremely helpful in helping you see the direction your enemy target is heading. The solid black line extending from the Target Designator is the F-16 computer's best guess on where the enemy target is heading. The dotted line trailing represents where the target has been.

LCOS comes in handy when you are trying to down a plane. You should always aim at the position just in front of the LCOS line allowing yourself to "pull lead" on your target. This is important because by the time you fire your bullets and they arrive at the location you were aiming at, the enemy plane would have already moved out of position.

Snapshoot

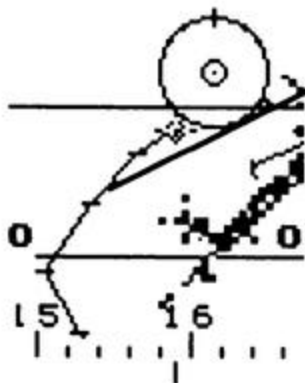

The Snapshoot (nicknamed the "Snake") is an undulating tracer line that extends from the Aiming Reticle. It indicates what the historical bullet path would be if your gun were being fired continuously. Because you're not always travelling in a straight line, it's difficult to know where your gun bullets would actually end up when you're firing the gun and making a hard turn at the same time. The harder your rate of turn when the gun is fired, the longer the Snake will extend from the Aiming Reticle. The Snake is very lively, and its position and length change continuously as your F-16 changes direction. You

should continue to use the theory of "pulling lead," but amend it to have the trailing end of the Snake making contact with the leading end of the LCOS. An optimal firing condition exists when the trailing end of the Snake is on top of the MiG and positioned within the Aiming Reticle.

How to Fire Your Gun

Once you have lined up the Aiming Reticle with the LCOS, squeeze your trigger in *short bursts* until the enemy plane explodes.

Air-to-Ground HUDs

To select from Air-to-Ground HUD Modes, tap the A-G Weapons Select key [**Backspace**] until your selection appears on the HUD Mode Indicator section of your HUD.

Air-to-Ground Bombing HUD (Mk 84 or Durandal)

The Mk 84 2000lb Low Drag Bombs and Durandal Anti-Runway Weapons use the same HUD sighting system, called CCIP Bombing.

CCIP Bombing

CCIP is the acronym for "Continuously Computed Impact Point." The targeting computer continuously calculates where a bomb will land, using altitude, speed, flight path, aerodynamics of the weapons, and other factors. It is a very accurate method of bombing.

The impact point is displayed on the HUD by means of a symbol called the **CCIP Pippier**. When the Pippier and the target coincide, the pilot presses the trigger (**Spacebar**), and the bombs are released. (This is the situation usually encountered in "dive bombing.")

Let's take a look at Pop-Up Bombing, which your Bombing HUD mode has been specially designed for. This is the situation when unlike in Dive Bombing, the actual impact point is below the HUD.

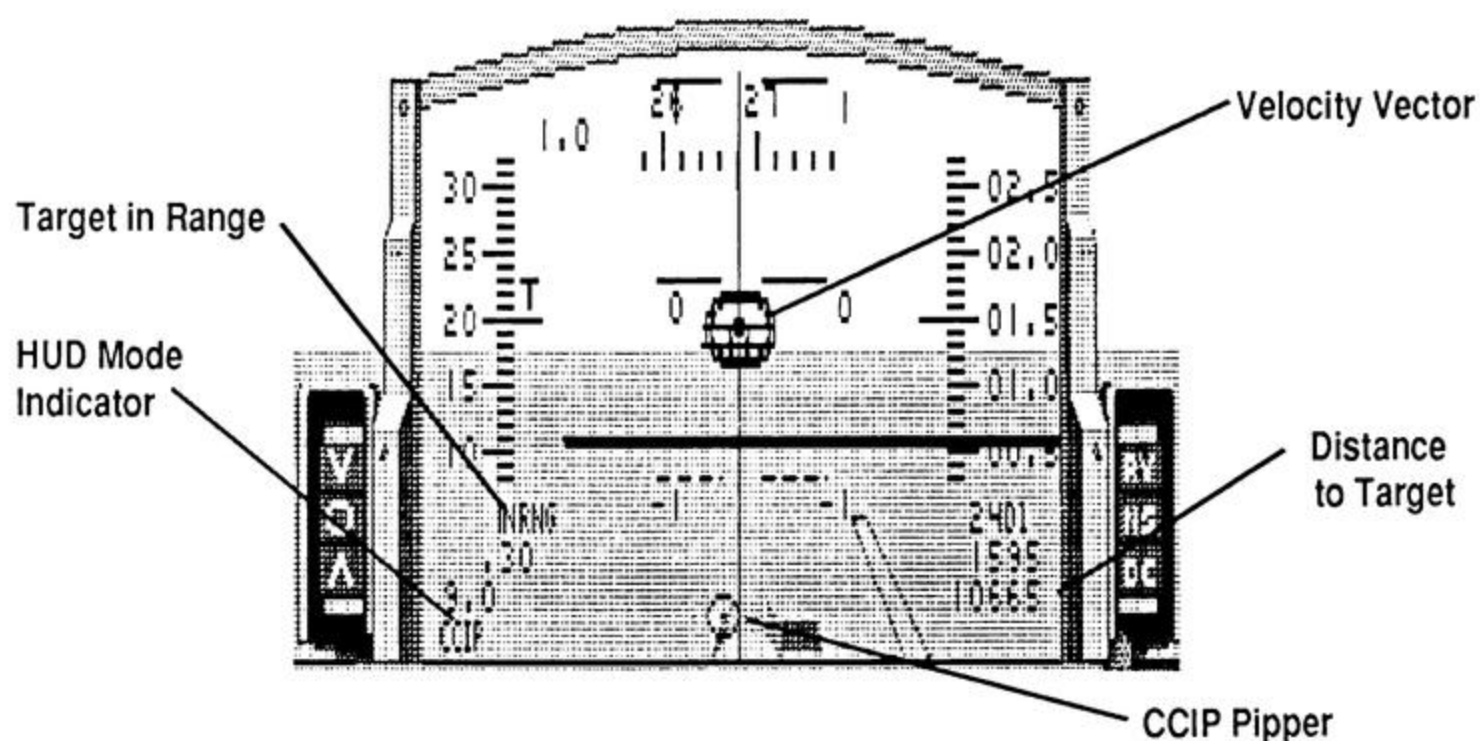

There are three major phases to Pop-Up Bombing. In each phase, the Bombing HUD changes. Phase 1 is called "**pickling**". This is where you lock onto the target with your visual sighting system. Phase 2 is the approach. This is where you level off and approach the target. Phase 3 is the climb and release phase of the bombing. *Pop-up bombing is effective at altitudes between 2,000 and 10,000 feet.*

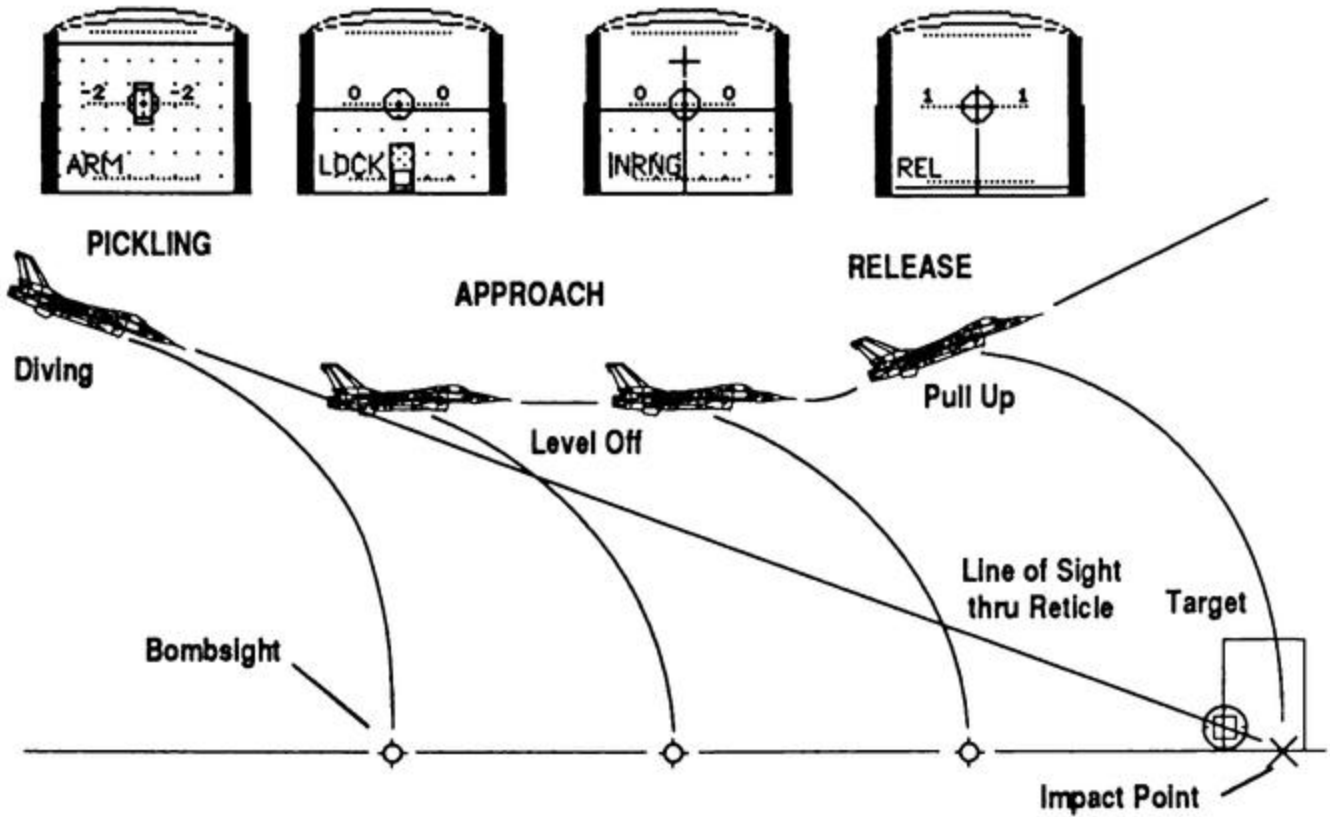

Phase 1: Pickling

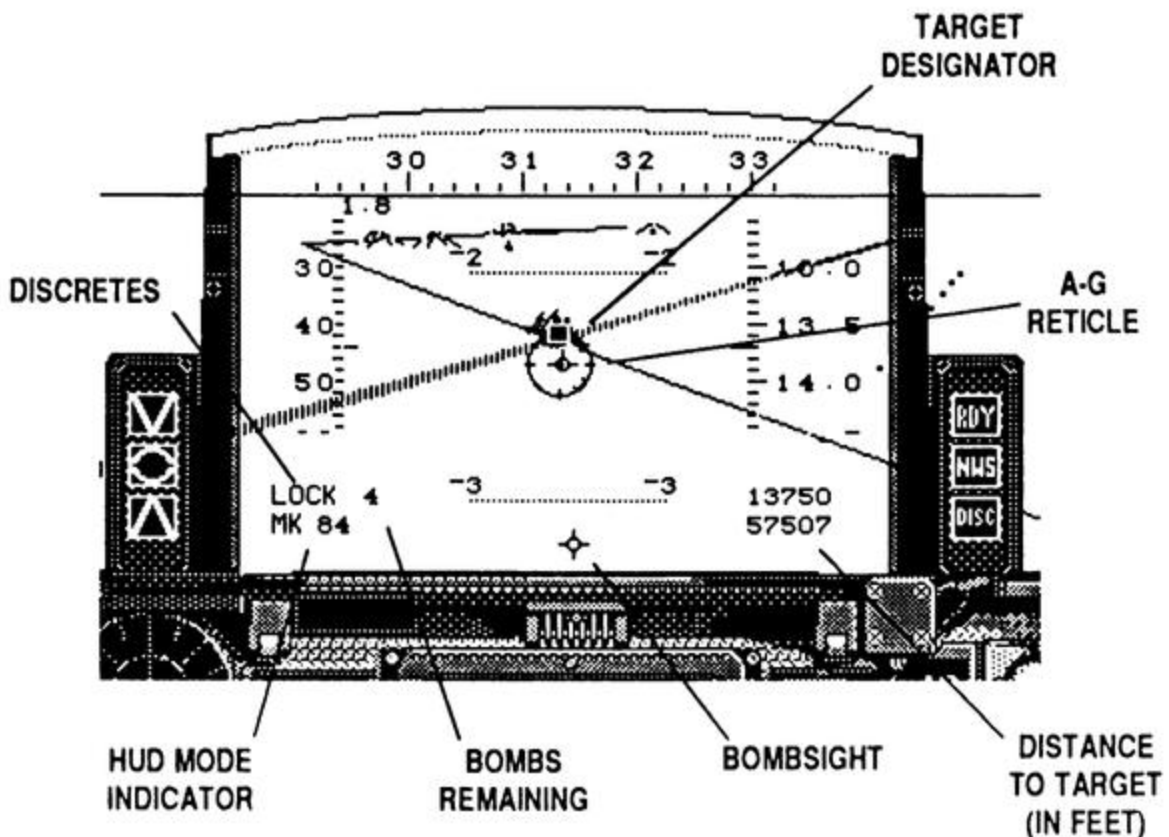

Discrettes

The Discrettes on the Bomb HUD indicate the status of your bombing. ARM means that your bombs are armed. LOCK means that the target has been acquired and that your trigger is "pickled" (bombs ready to be released). REL signifies that bombs have been released.

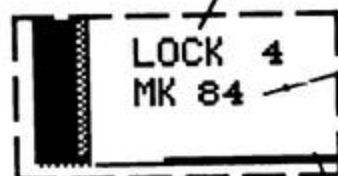

HUD Mode Indicator

This tells you that the bombs you are selecting are either the Mk 84 2000lb Low Drag Bombs (MK 84) or the Durandal Anti-Runway Bombs (DUR).

Target Designator

Indicates the target your radar is tracking. You use the Air-to-Ground Reticle to aim at the target, and when you press the Trigger a first time to "pickle" the target, a Target Designator appears in the aimed area. It will follow the target up until bomb impact or until you have completely passed over the target.

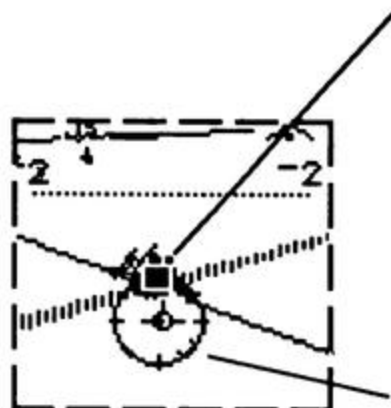

Air-to-Ground Reticle

The A-G Reticle is the device you use to align with a target for a lock-on. This form of Reticle is "fixed" on the HUD centerpoint for ease in aiming.

HOW TO LOCK-ON TO YOUR TARGET

Maneuver your plane so that the A-G Reticle is perfectly aligned with the target you intend to bomb. This usually requires that your plane go into a shallow dive. Press the Trigger once to "pickle", or "target designate" whatever the Reticle is pointing toward. The Target Designator will appear within the Reticle. The LOCK discrete will appear on your HUD.

Make sure that the Target Designator is totally aligned with the object you intend to bomb. If it isn't, "clear the pickle" by pressing the Clear A-G Target Lock key (X). The LOCK discrete will disappear when you clear the A-G Target. Try to realign your Reticle and start the lock-on process again.

If the target has been properly locked-on, level your plane out and fly straight toward the target. Since your Trigger is already "pickled", a pair of bombs will be released the next time you press it.

Phase 2: Approaching

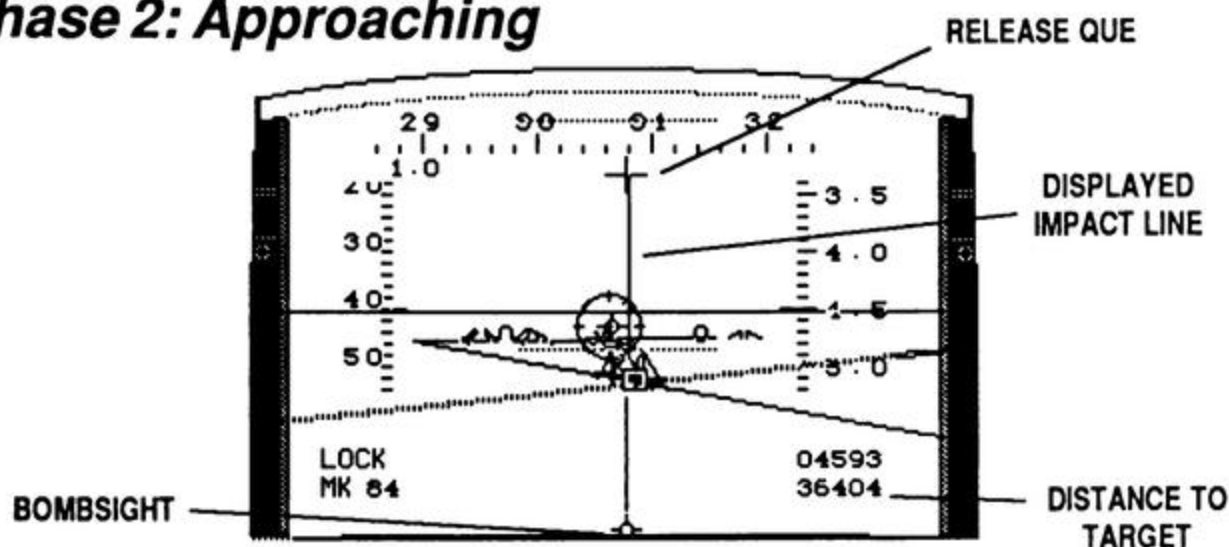

Distance to Target



The distance to the target (in feet) will appear as you close in on your objective. Altitude is considered in the distance computation.



Bombsight (CCIP Pipper)

The Bombsight may appear as you get closer to the target. This represents the location of where the bombs would hit if they were released at that instant. Don't worry if you can't see the bombsight, it's probably below your plane of view.



Release Que & Displayed Impact Line

The Release Que and Displayed Impact Line will appear right before your plane gets in range of the target. The Displayed Impact Line plots a direct line between the Release Que and the bombsight. If the Bombsight is below your plane of view, then the Impact Line will go to the edge of the HUD.

To stay on course, you must maneuver your plane so that the Displayed Impact Line intersects the Center Point and the Reticle.

Phase 3: Release

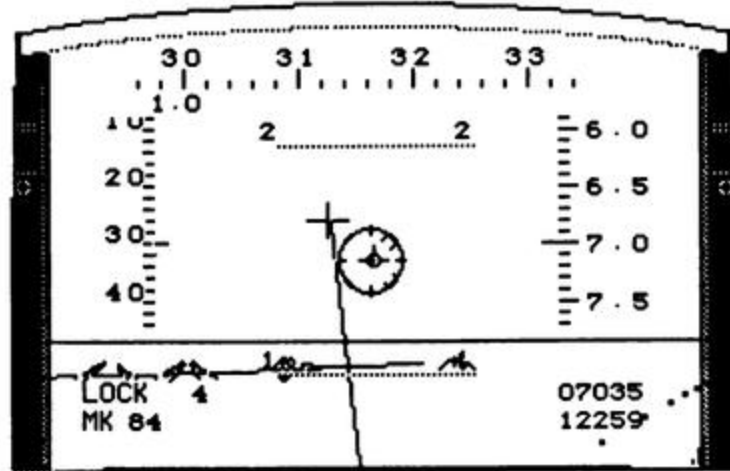

Release Que & Displayed Impact Line: Releasing the Bombs

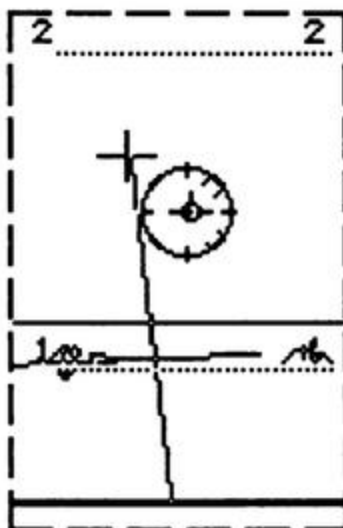

As you approach the target, the Release Que will slowly move down the HUD toward the Reticle. Once the target disappears below your HUD, pull back on the stick and start a shallow climb of about 10 degrees. When the Release Que passes through the Reticle, press the Trigger to release a pair of bombs. The further the Release Que is from the Reticle when you release your bombs, the greater the distance between the impact point and the target. The REL discrete will appear once the bombs are released. After bomb release, increase to full power and initiate a 40 degree climb until you have cleared the impact area. Depending on your altitude, angle of climb, and speed the time it takes from release to impact will vary.

Air-to-Ground Missile HUD (AGM-65B MAVERICK)

The AGM-65B Missile is designed to be visually locked-on to a ground target by the pilot. In the front end of each Maverick missile is a TV camera with a zoom lens. The television image is fed to the pilot through the **COMED**. This allows you to acquire your target electronically from distances beyond visual range.

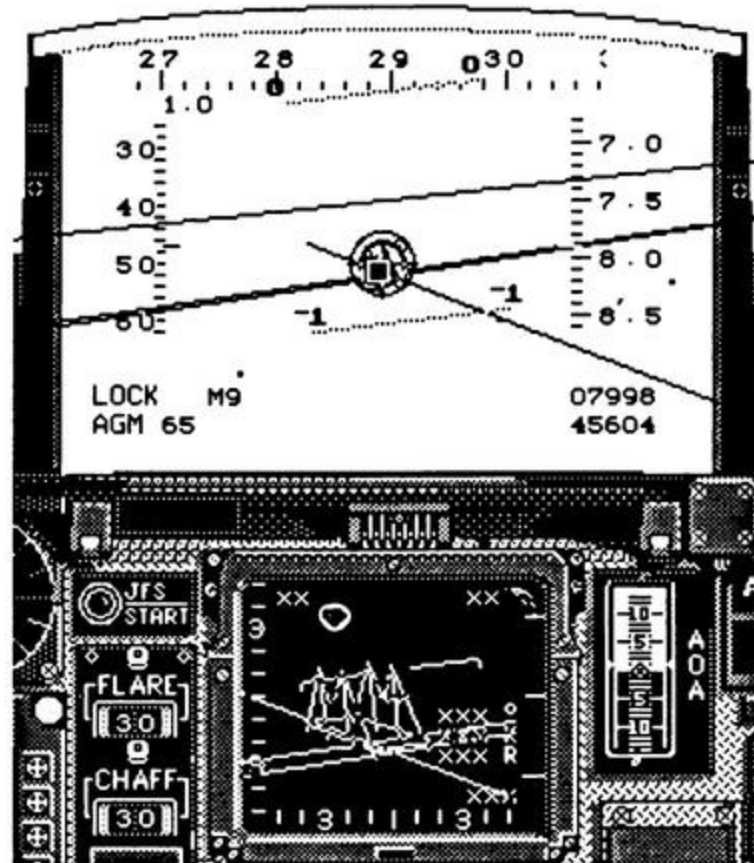
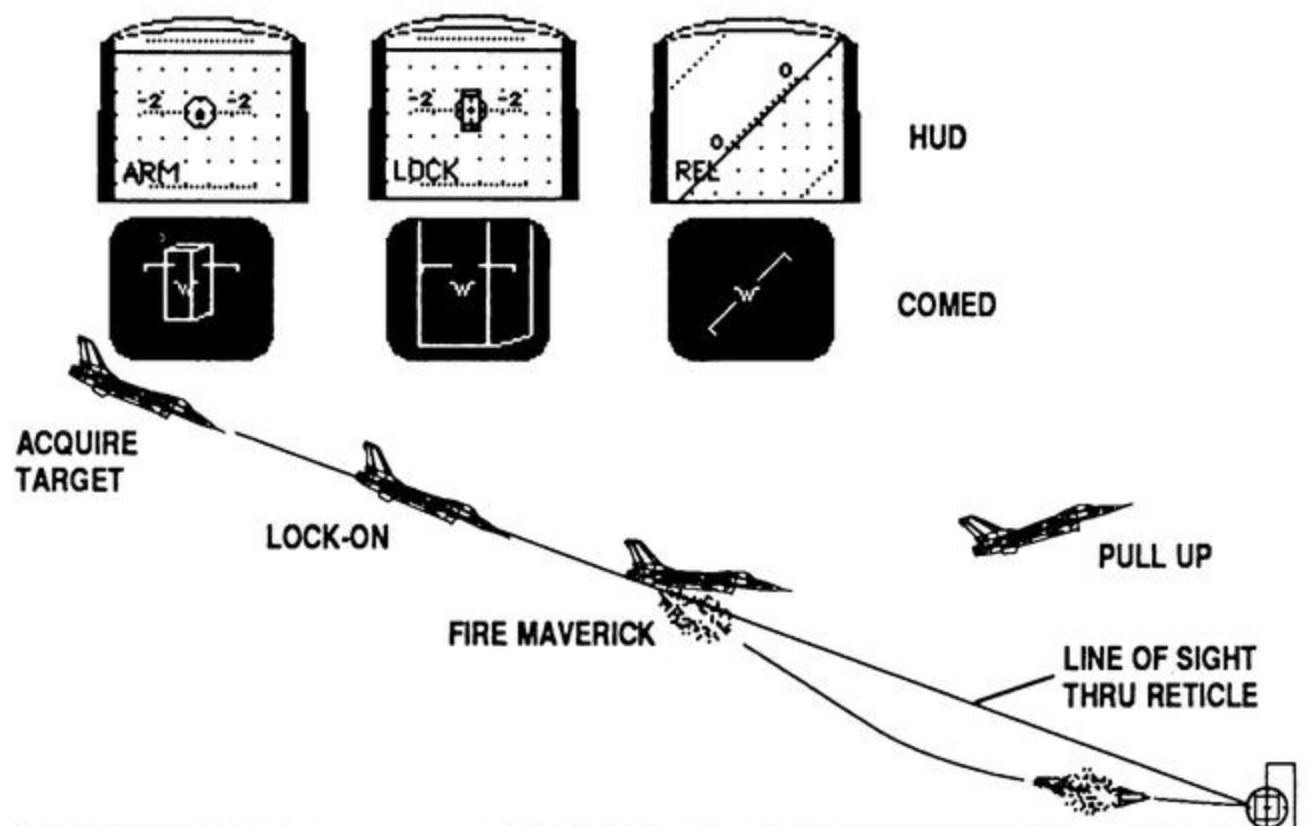

Discretes

The discrettes on the AGM-65 HUD describe whether or not your missiles are **ARMed**, **LOCKed-on**, in range of a target (**IN RNG**), or **RELEased**. If no message appears, it means that there is something wrong with the system or that you are out of missiles.



HUD Mode Indicator

Displays **AGM 65** to indicate you're in Air-to-Ground Missile HUD mode.

Air-to-Ground Reticle

Use the "fixed" A-G Reticle to align with a target for a lock-on.

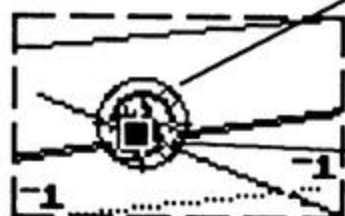

Target Designator

Appears when you press the Trigger the first time to lock-on to a target. It will stay locked-on to the target until you pass the target.

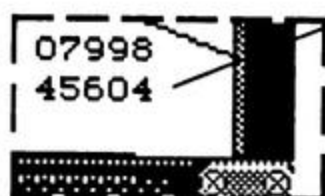

Distance to Target

Once you have locked-on to a target, the distance to the target (in feet) will appear in the bottom right HUD area as you close in on your objective. Altitude is considered in the distance computation.

HOW TO FIRE A MAVERICK

Select the Air-to-Ground Missile HUD mode by pressing the A-G Weapons Select key (Backspace) until AGM 65 appears on the HUD Mode Indicator line of the HUD. Next, you need to make sure that you're in Radar mode on the **COMED** so that you can view a target through the Maverick's zoom lens. If you're still in Map mode, switch to Radar mode by toggling the COMED with the "C" key.

As with bombing, firing a Maverick requires that you "pickle" your Trigger. Align a target with your Reticle by flying directly toward it in a shallow dive. Once you have aligned the target with the waterline in the COMED or with the Reticle in the HUD, press the Trigger once to pickle the target. Once you have pickled the target, LOCK or IN RNG will appear on the HUD discrete line. If you misaligned the target, clear the lock-on by pressing the Clear A-G Target Lock key (X).

Once locked-on, you needn't continue to dive directly toward the target. The target will continue to be locked-on as long as your plane is heading in the general direction of your target. As soon as the IN RNG light appears, you can fire a Maverick by squeezing the trigger. The target will stay locked-on until you pass it or hit the Clear A-G Target Lock key.

Air-to-Ground Strafe Gun HUD (M61A1)

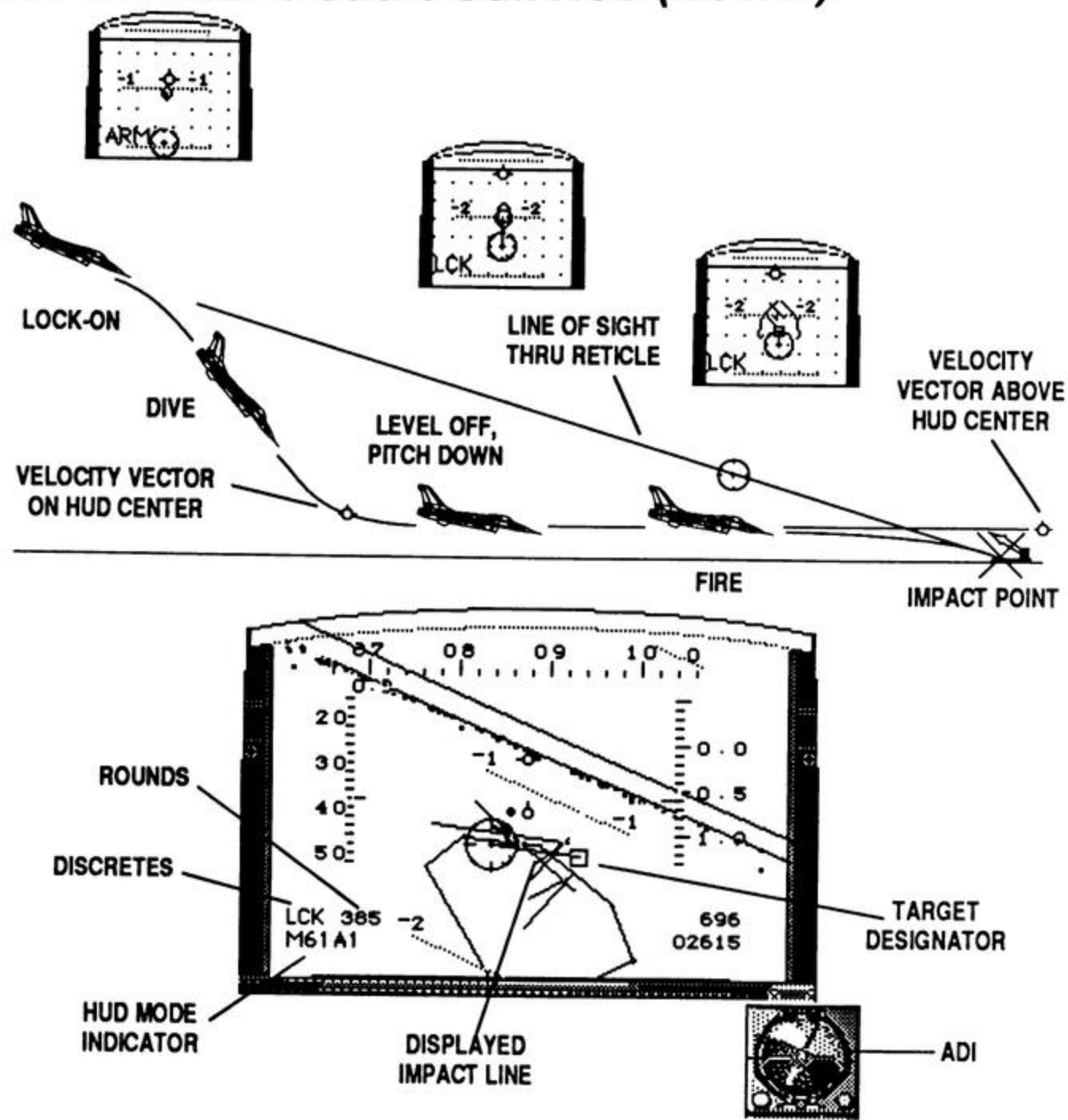

Discrettes

The Discrettes on the M61 HUD indicate if the gun is **ARMed** or if you are tracking your target (**LCK**). If no discrettes appear, then your gun is either out of ammo or is jammed.



HUD Mode Indicator

Displays STRF to indicate that you are in A-G Strafe Gun mode.

Rounds

Indicates the number (x 10) of gun bullets remaining.



Target Designator

Indicates the target your radar is tracking.

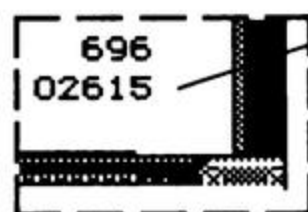

Distance to Target

Once you have locked-on to a target, the distance to the target (in feet) will appear as you close in on your objective. *Altitude is considered in the distance computation.*

Air-to-Ground Reticle

The F-16 firing control system automatically computes where your bullets would be by the time they reach target range. The firing control system then plots the "mobile" A-G Reticle at the precise place the bullets would land if you fired instantly.

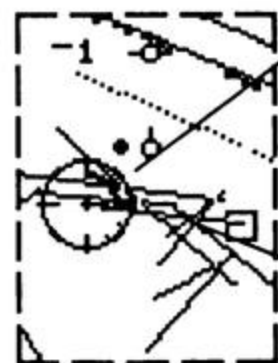

Displayed Impact Line

Appears after you've locked-on to a target, and connects the Target Designator with the Reticle.

HOW TO FIRE YOUR GUN

First adjust your pitch with the Yaw/Pitch Control (Alternate) key by holding it down while pushing your stick forward, so that the plane is fully pitched down. Check your Velocity Vector on the HUD, or Yaw/Pitch Control Indicator on the left side panel (Left View) if the HUD is damaged. *If the HUD is functioning, the Velocity Vector should rise above the Center Point.*

The imaginary line (“vector”) drawn through the Velocity Vector symbol represents your plane’s true line of flight, while you are merely pointing the nose of the F-16 downward and aiming your weapons through the center point of the HUD in that general “downward” direction.

After you have switched into Strafe mode, you’ll need to align the target with the HUD Center Point and press your Trigger once for a lock-on (“pickle” the gun). **LCK** will appear on the HUD Discrettes.

Maneuver the plane so that your Reticule is aligned with the target. Press the Trigger to fire.

Once you have passed the target, you’ll need to lock-on to the next target. *If you want to ignore the lock-on ranging system, pump your Trigger in short bursts instead of holding it down in one long burst.*

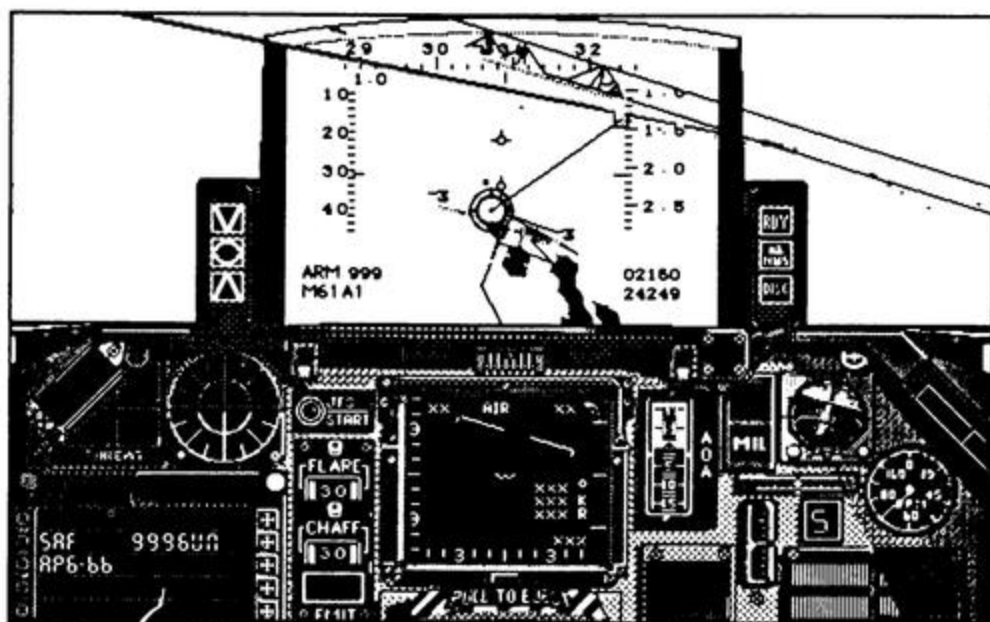









SUCCESSFUL STRAFE ATTACK ON SAM SITE

Front Panel

AOA (Angle of Attack) Controls

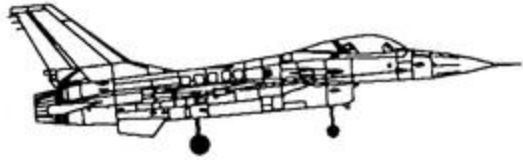
The AOA controls display the F-16's "angle of attack" and are used primarily to assist in landing the plane. As the illustration shows, the plane needs to approach the runway at the right angle when landing, and the three components of the AOA display will give feedback on the plane's attitude.

INCOMING ANGLE OF F-16	INDEXER	INDICATOR
 <p data-bbox="217 1061 566 1106">TOO HIGH AND SLOW</p>		
 <p data-bbox="181 1340 612 1385">GOOD ANGLE AND SPEED</p>		
 <p data-bbox="227 1612 566 1657">TOO LOW AND FAST</p>		

ANGLE OF ATTACK (AOA) AND RESULTING FEEDBACK

AOA Indexer

The AOA Indexer is located to the left of the HUD and has three symbols that light up separately depending on your landing approach angle. If the middle light is on, you are at the perfect AOA (8 to 13 degrees) for landing. If the top light is on, your angle is too steep. When the bottom light is on, your AOA is too low.

AOA Indicator

A numeric AOA Indicator is located in the main cockpit view to the right of the COMED screen, and displays the AOA in degrees.

You control the F-16's AOA by varying (1) the plane's speed with the **throttle** controls, (2) the rate of dive with the "stick" control, and (3) the amount of **pitch** with the yaw/pitch control. During normal flying, you can bleed off (reduce) speed with a high AOA. The more g's the plane pulls, the higher the AOA will be. **Maintaining low speed and high AOA usually prove fatal in battle.**

Nose Wheel Steering System/Landing Gear Status Indicator (NWSS/LGSI)

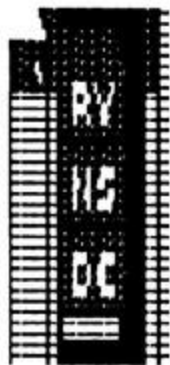

RY (Ready) Light

The RDY light on the NWSS/LGSI (whew!) signifies that the NWS system and the landing gear are not damaged and you're ready to roll. The light will stay on while the landing gear is down, assuming there is no damage to your NWS System.

NS—Nose Wheel Steering System Operation Light (AR/NWS)

Lights up to indicate that the Nose Wheel Steering System (front wheel) is activated and operational. At this point the plane's steering mechanisms switch from the ailerons to the nose wheel, so you can taxi the F-16 on the runway. When you start down the runway before take-off, the NWS System is automatically activated.

The AR/NWS light will go out when the plane reaches **70 knots** ground speed, signifying that the Nose Wheel Steering System is prevented from turning on the runway. The NWS System does not truly "disconnect" until the plane has left the ground, when the **DISC** indicator will light up.

DC Indicator

The DC light turns on after the F-16 takes off. It's purpose is to verify that the plane has left the ground and the steering functions have been "disconnected" from the Nose Wheel Steering System and switched to the ailerons, so the F-16 can bank and roll. The light stays on until the landing gear is up.

The landing gear should be raised immediately upon take-off ("**G**" key). **Don't exceed a speed of 300 knots with the landing gear down or you risk damage to the mechanism.** At the upper levels of **FALCON**, your plane will go into a tailspin @ 300 knots if you haven't raised the wheels. Even though the DISC Light pertains specifically to the Nose Wheel Steering System, it serves as a reminder to raise the landing gear (or lower it during landing, as it were, when the light is off).

Master Caution Light



The Master Caution Light will light up when damage of any kind has occurred to the F-16, whether induced by combat or random occurrence. This is a signal to look at the right side of the cockpit for the specific warning light.

When the Caution light appears, press the "6" key on the top row of the keyboard to toggle to the Right View. The panel below the canopy line contains specific caution lights for the damage or malfunction that has occurred.

Threat Indicator and Warning Panel

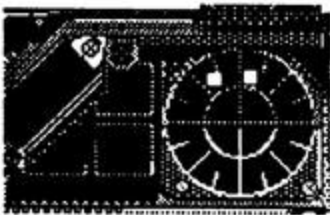

The threat warning system alerts you if:

- 1) an enemy plane has been picked up on your Threat Indicator
- 2) an enemy plane has "radar missile lock" on you
- 3) a missile has been launched towards you
- 4) a SAM site has launched a missile

Enemy planes show up as dots on the Threat Indicator. The Threat Indicator indicates relative position only, and not distance from the enemy plane to you. (If the enemy MiG is in the 180° area in front of your plane, it will also show up on the Radar Display, and show its distance from you when within 28 miles.)

If the enemy has "missile lock" on you with a radar-guided missile, then a flashing "LCK" will appear on the Threat Warning Panel. If a radar-guided or heat-seeking missile has been launched toward you, a flashing "LNC" will appear in the bottom Threat Warning Light location.

At the Colonel level of **FALCON**, the enemy MiG's may not have their radar systems turned on. The Threat Indicator only picks up planes which emit radar signals, so you will have to make visual contact in this situation. The first indication that a MiG is in the area might be when the LOCKON or LAUNCH lights appear. Comforting thought, huh?

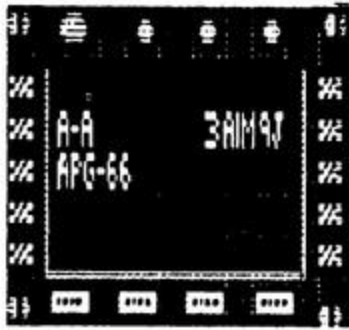

Stores Control Panel

This cockpit panel displays the conditions inherent in the currently selected HUD mode. In the sample below, the Air-to-Air HUD is selected, radar (APG-66) and LCOS are turned on, and AIM-9J missiles are activated and ready.

In **FALCON**, one way to see all the weapons stores currently on your plane would be to toggle through the HUD modes. A more efficient way to do this is by pressing the "V" key. You will see all the weapons listed on the Stores Control Panel without having to exit the current HUD mode. In this manner, you can monitor all the weapons you have remaining at any time, something which must be done quickly in the heat of battle.



Engine Fire Light

You may encounter an engine fire during battle if the enemy bullets are well placed. When this light comes on, your only choice is to eject from the plane. Refer to the Ejection Handle paragraph following for more information.



Autopilot Light

When the autopilot is engaged, this light will be lit. **FALCON** will track toward the target for the current mission, or will track a MiG if one is present.



Jet Fuel Start Light

This light will turn red when the engine is started. On the ground, it is green before the engine is started. Occasionally however, if you incur a severe stall while in the air, you may have to restart the engine. You'll know if the **Start** light is green.

When starting up your engine at the beginning of the game, press either "+" key once to initiate JFS Start. The engine RPM will increase until it reaches 60 percent, when the Jet Fuel System Start light will go out, and the main engine throttle control will take over. If you suffer a rare engine shutdown due to a severe stall in the air, you'll know by looking at the RPM gauge, where the needle will have dropped to zero. If the sound is toggled on, you'll hear the engine die. The best way to restart the engines in the air is to press either "+" (plus) key while in a controlled dive, and level out once the engine is throttled up again.



Run Light

When the engine is running, this light is red. Otherwise, it is yellow.



Flare Indicator

Your F-16 is equipped with flares which are designed to fool heat-seeking missiles. The Flare Indicator tells you how many flares you have remaining on the plane. You start with 30 flares on board at the beginning of each flight.

*Shoot off flares by pressing the Keypad 0 key. It's very important that you don't release your flares too soon, in order to properly force the incoming missile to seek the flare instead of your exhaust pipe. Heat-seeking missiles are almost always used at close range. Remember, if your Threat Warning light shows a "LOCK ON" (enemy missile lock-on) warning before the "LAUNCH" (enemy missile launch) light appears, the enemy plane has fired a radar-guided missile at your F-16, and flares won't do any good. **Be generous with flares! It won't make any difference if you have flares remaining when a missile flies up your six!!!** (P.S. Heat-seeking missiles especially like planes with afterburners flaring.)*

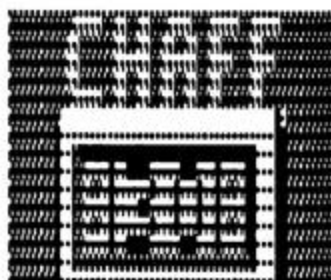

Chaff Indicator

Chaff are packages of tiny foil strips which confuse radar-guided missiles. The Chaff Indicator shows how much Chaff you have remaining on your plane. Each plane starts with 30 packages of Chaff aboard at the beginning of the game.

You can dispense Chaff by pressing the "Keypad •" key. Chaff has no effect on heat-seeking missiles, so only use it when the "LOCK ON" light has appeared on the Threat Warning System before the "LAUNCH" light appears. Missiles that are fired from distances of greater than 7 miles are almost always radar-guided. The same generosity principle discussed in Flare usage applies here as well.

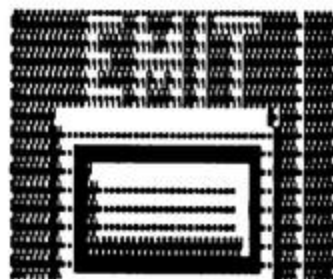

Emit Indicator

The Emit Indicator registers the use of ECM (Electronic Counter-Measures) which is employed via the **ALQ-131** Pod (and the "E" key) installed on the bottom of your F-16 to foil ground based SAM (Surface-to-Air Missile) sites. Emissions can also be used on MiG planes which have radar-guided missile lock on you. This confuses their radar. The problem with using ALQ-131 emissions is that it announces to the world that you are coming. Therefore, you should use it only after being acquired by an enemy plane or SAM site. *By definition, ECM includes the Threat Warning System, Chaff, and the above-mentioned ALQ-131 Pod, so you will hear it discussed as it relates to each of the different systems.*

If you are going to fly a mission that involves being around SAM sites, you should request an ALQ-131 ECM Pod from the crew chief during the Armament screen sequence.

COMED (Combined Map/Electronics Display)

The COMED is one of the most important monitors in the F-16 cockpit. This view will update you constantly on enemy plane position relative to yours, along with what changes are taking place as the MiG maneuvers and changes position.

If you are on a mission that involves ground sites, you can toggle this screen to a Map mode to aid in locating target positions.

As important as the COMED screen is to your effectiveness in battle, there are times when you may want to switch it off so as to avoid being detected. The Radar screen can be toggled off and on with the "R" key. Also, there is a possibility of your Radar being damaged by enemy fire. It will still be possible to win the battle, especially at the lower ranks, but any FALCON player who defeats an enemy MiG without Radar at the Colonel level is pretty special. Sierra Hotel, if you know what I mean. (Just ask any real fighter jock.)

Ejection Handle

The Ejection Handle is the last hope for a fighter pilot in distress, and an option you should choose only if absolutely necessary due to severe plane damage.

Press the "Control-E" key combination to eject from your F-16. **Never eject when the F-16 is upside down (or more than 60 degrees from level) unless you want to be a human javelin and end up with a permanent headache.** Your chances of hitting the canopy shell upon ejection are high if your plane is moving relatively slow or is in a flat spin (like a top). And we all know what happens when that occurs.

WARNING

If you eject behind enemy lines, you're certain to be captured and retained as a POW (Prisoner of War).



(Air) Brake Light

Located to the right of the COMED and shows when Air Brakes are being applied. Invoke them ("B" key) when you need to make a quick reduction in speed, whether in the air or on the ground. They should be used in combination with Flaps and Wheel Brakes to completely stop your F-16 after it has landed.

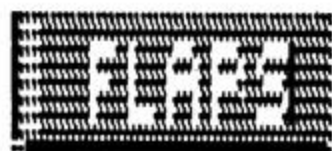

Flap(s) Light

Located immediately above the Air Brakes and shows when (wing) flaps are down. Wing Flaps are used both to create lift and help slow the F-16 upon landing. They're toggled down and back up with the "F" key.



Afterburner/Military Power Indicator

This cockpit light indicates whether you are currently using standard Military Power, which is a term for normal engine usage and acceleration, or invoking the engine's Afterburner for extra acceleration. There are five stages of Afterburner use, as indicated by the cockpit lights. Stage 1 is a little more power than MIL and Stage 5 is full burner.

Afterburner vs. Military Power: In *FALCON*, the Afterburner is engaged by pressing the "I" key. Pressing "I>" increases the Afterburner stage, up to stage 5. To decrease the stage, press "I<". To return to Military Power, press the "I" key. The use of Afterburner allows your plane to go supersonic as well as improve acceleration and climb rate. It can also be used to enable a faster take-off from the runway. The trade-off is that the Afterburner uses a tremendous amount of fuel. Plus, remember that heat-seeking missiles just love a little extra heat to go around.



Attitude Director Indicator (ADI)

The ADI (sometimes called the "level ball") is used to help register your plane's position relative to the horizon as it rolls and pitches in any direction.

Visualization Aids for the F-16 Pilot: When you're up in the air flying around, watch the position of the ADI change as the plane banks and rolls, or changes altitude. Note how the line separating the sky from the ground matches to the "water line" on the Radar display, the lines of the Flight Path Ladder, and to the real horizon line itself. Most pilots use all these visual cues when flying their jets. When things get hot and heavy up there, it's nice to have several ways to orient yourself as your eyes are darting around the cockpit.



Sensitivity Indicator

Another feature specific to your computer version of the F-16, this indicator sets the sensitivity of the plane to pitch and roll speed. The sensitivity varies from 1 to 9. If you select "1" sensitivity, the plane will be less "sensitive" to changes in direction, and will be easier to control. At the "9" setting, the turn, dive, and climb characteristics of **FALCON** are virtually identical to the actual F-16, with the most realistic setting being "9" sensitivity while flying at the rank of Colonel. The default sensitivity level is "5." Press "F3" to decrease the sensitivity level, or "F4" to increase it.



(Wheel) Brake Light

The Wheel Brakes are used to control the F-16 when it is on the ground. When this light is on, the Wheel Brakes are engaged.

*When you first enter the **FALCON** cockpit, the Wheel Brakes are engaged. When you press the Jet Fuel System Start key ("+") to start your engine, make sure the Wheel Brakes are left engaged unless you want the plane to start rolling. You can release the Wheel Brakes at any point (by pressing the "W" key) if you want to taxi the plane to a specific runway. Reengage the Wheel Brakes when you wish to stop. When in position for take-off, leave the Wheel Brakes engaged until RPM is between 60-80%, then disengage them. If you wait until after RPM has reached 80% to release the Wheel Brakes, the NWS (Nose Wheel Steering System) and/or Wheel Brakes may be damaged, depending on your rank at the time. In similar fashion, the Wheel Brakes are used to stop the plane completely upon landing (within the same RPM guidelines). You should use Air Brakes to slow down the F-16 when its still packing a full head of steam after touching down. Wheel Brakes are designed to stop the plane only when it's moving slowly.*



RPM Gauge

The RPM (Revolutions per Minute) Gauge reflects the **percentage** of power being applied with your F-16's engine. The numbers on the gauge represent increments of percentage (%) power that the F-16 engine is producing at any particular time, from zero all the way up to 100 percent. All other factors being equal, the percentage of RPM directly relates to the plane's airspeed. After you play FALCON for a while, you'll know instinctively what percentage of power to apply to reach a certain airspeed.

*As you increase in rank during the game, you'll be required to monitor the RPM Gauge more closely. The most common situation with RPM percentage is during the take-off procedure. **Some of the percentages to remember** Your plane will start to roll @ 40% RPM during start-up. From take-off position, throttle should be increased to between 60-80% RPM before releasing the Wheel Brakes to proceed down the runway. If you wait to release the Wheel Brakes until after 80% RPM is reached, the NWS (Nose Wheel System) and Wheel Brakes may be damaged. Increase RPM to 100% (and invoke the Afterburner) for a shorter take-off, or to compensate for a heavy load.*



Stall Light

The Stall Light illuminates when you have exceeded the F-16's engine performance envelope, causing it to stall. This can occur for various reasons, but the most common one is that air intake has been reduced sharply, due to performing maneuvers at either high altitudes in thin air or at too low an airspeed.

FALCON does not stall under any conditions at First Lieutenant or Captain ranks. At Major level and up, however, the F-16 will be increasingly more susceptible to stall conditions. During a stall, your plane will begin to shake. The best action to take during a stall is to accelerate in a dive until the engine refires and stabilizes, then level off. You'll start to realize after playing the game for awhile why dogfight engagements take place at middle altitudes. Planes engines gasp for air as well as fuel, and theres not much of it at high altitudes. Plus, you occasionally need room to recover beneath your position, and the ground can greet you fairly quickly when you're flying at Mach 1

The Left Side View

Press the "4" key on the top keyboard row to switch to the left side view. This view looks out the left side of the canopy glass, and gives access to some very important gauges.

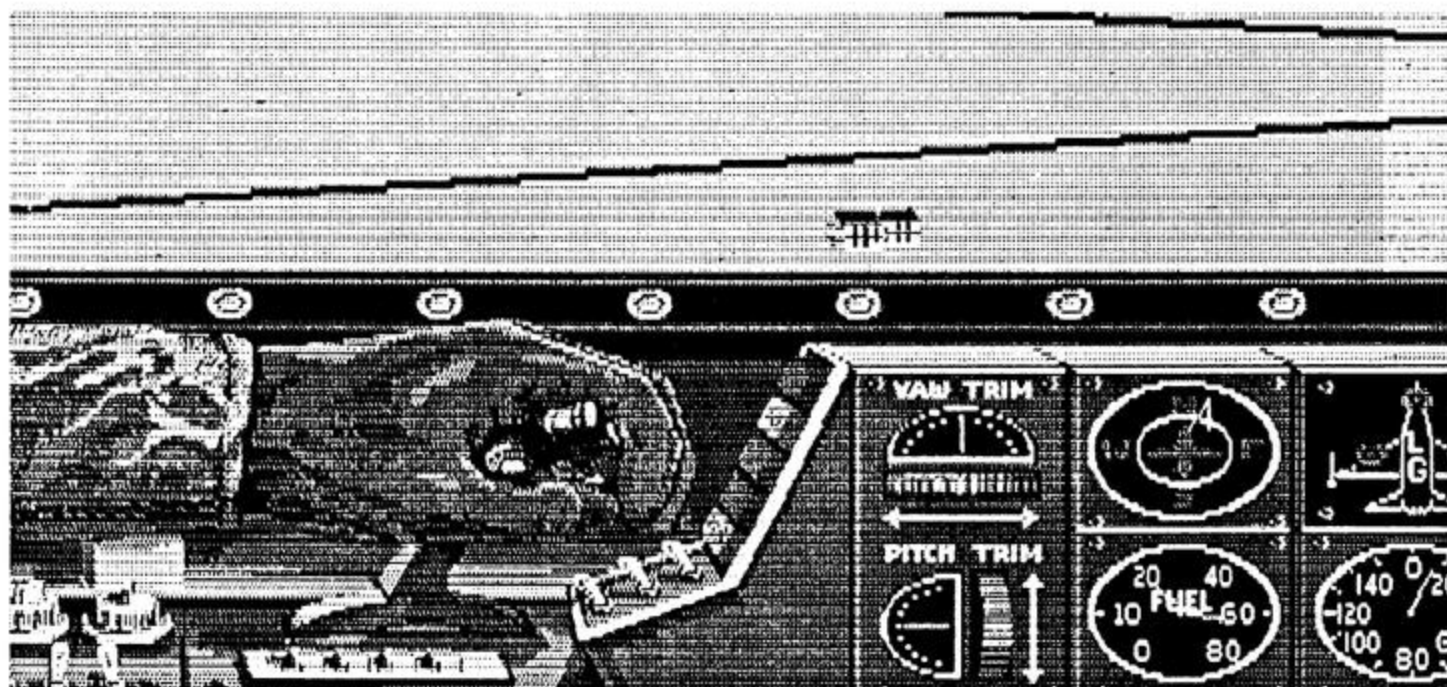

Yaw/Pitch Controls

Yaw Trim and Pitch Trim relate directly to the Velocity Vector discussed earlier in the HUD descriptions. Although you can visually line up your yaw and pitch changes through the HUD, there may be times when the HUD is inoperable due to damage, and the Yaw/Pitch Controls will serve as a backup so you can re-orient the plane for landing or targeting reasons. Each dot on the yaw or pitch dial represents two (2) degrees.



Fuel Gauge

The Fuel Gauge represents the amount of remaining fuel in hundreds of pounds. Because you may not be in the habit of looking out the Left View on regular occasion, a prompt will appear near the center of the HUD glass if your fuel is getting low. When the word "FUEL" appears on the HUD, you should check the fuel gauge. If you have not yet reached the mission's destination, you may have to abort the mission.

You'll notice there are two needles on the Fuel Gauge. One represents the fuel remaining in any **external** tanks, while the other shows the remaining **internal** fuel. *Any added external tanks are used up first.*

Your plane starts with 6950 points of fuel (give or take 300 pounds) in the internal fuel tank, so one needle will be initially placed between "60" and "70" on the dial. Each external tank adds 2000 pounds, so the other needle will be placed appropriately, according to the total number of external tanks added. *If no external tanks are added, that needle will be resting at "0" (zero) before you fire up the engine.*

Your Fuel Gauge will be a good indicator of how expensive Afterburner use can be. Be conservative on fuel usage: only fly at high speeds and use Afterburner when absolutely necessary. Missions at Colonel level won't be accomplished by showboating. Save that stuff for your sports car.



Compass

The Compass shows your plane's magnetic directional heading. Although you'll orient your self normally with the HUD Heading Scale, the Compass makes an invaluable backup if your HUD has been damaged

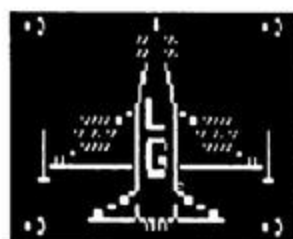

Landing Gear Lights

The Landing Gear Lights will be illuminated when the gear is down. If you try to toggle "on" the gear before landing and the lights don't appear, you'll be forced to land on the F-16's belly.



Backup Airspeed Gauge

The dial is a backup for the Airspeed Scale on the Head-Up Display, and will be useful if the HUD electronics get knocked out by enemy fire. Just like their counterparts in the HUD, the numbers represent the airspeed in tens of knots.

The Right Side View

Press the "6" key on the top keyboard row to switch to the right side view. This view looks out the right side of the canopy glass, and gives access to the secondary caution lights. Select this view when the Master Caution Light has flashed and check for specific damage.

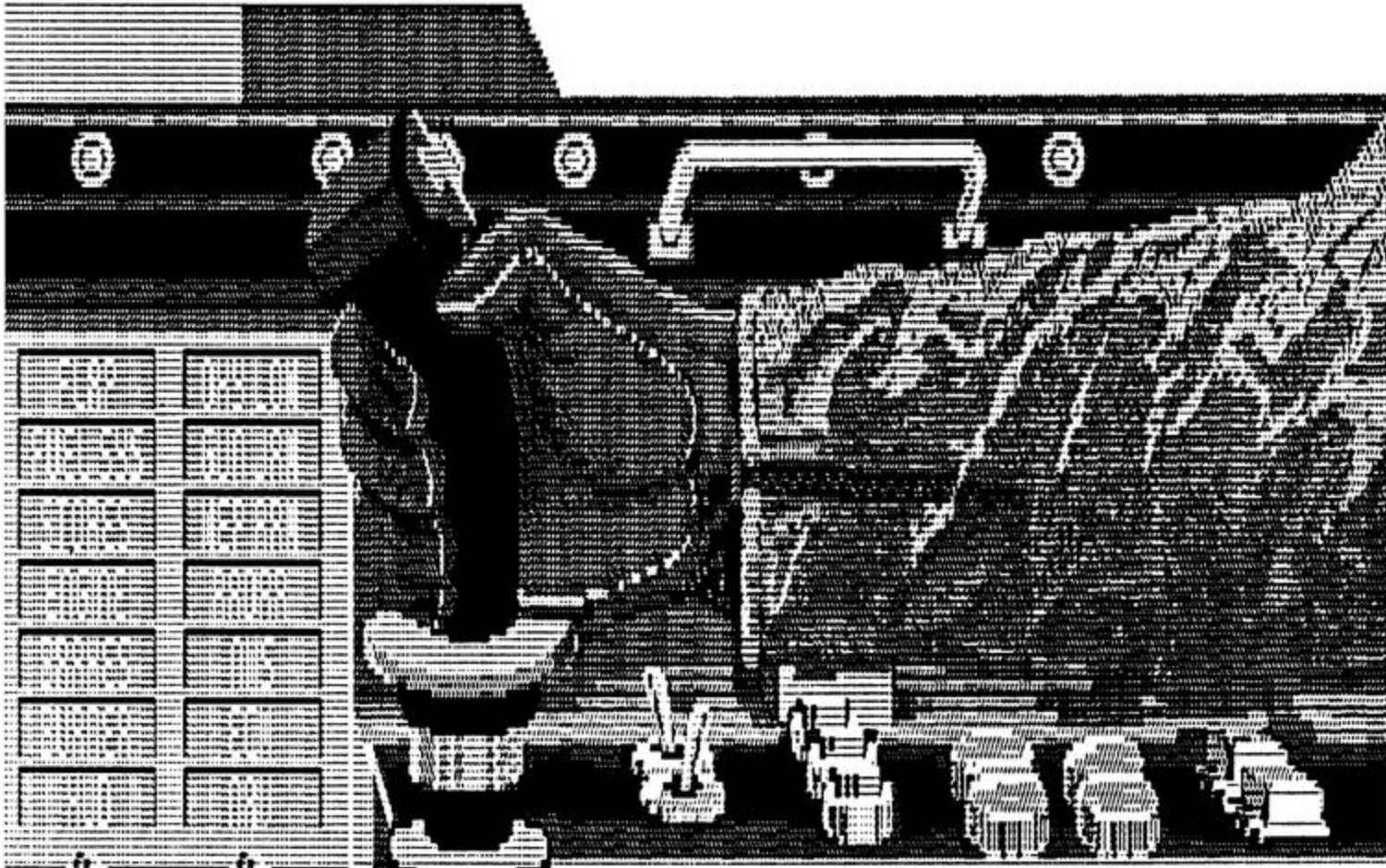

Caution Lights

FLAP

The Flaps have been damaged and frozen in their current state. If they were up when the damage occurred, they stay up. Since Flaps help curb excessive speed, the plane may be much harder to land. If the Flaps were down when the damage occurred, they stay down. This will hamper your plane's maneuverability, and prevent it from reaching top speed.

STORES

If the STORES light appears, weapons cannot be released from external stores. However, the M61 cannon (machine gun) and any AIM-9J/9L missiles can still be used, if available.

BRAKES

The BRAKES light indicates a failure in the Air Brakes system. If the Air Brakes were open when the damage occurred, they stay open. Similar to Flaps damage, this situation severely alters your plane's maneuverability, and forces it to fly at reduced airspeed. If the Air Brakes were closed when the damage occurred, they stay closed. The F-16 will be harder to land in some situations without the ability to brake and slow it down.

GUN JAM

The GUN JAM warning indicates that your M61 cannon is jammed and won't fire. You will have to rely on any remaining external stores for combat purposes, assuming that *they* are functioning OK.

NWS

If the NWS light is illuminated, the Nose Wheel Steering System has been damaged due either to (1) not following proper take-off procedures, (2) not landing well on approach, or (3) being hit by enemy fire. If the NWS System is disabled, the plane will not be able to be steered once it has landed, risking more severe damage if it doesn't land very straight and moves off the runway.

WEP ARM

Can't arm the selected weapons. Once again, you'll have to rely on any remaining M61 rounds, if the gun is functioning.

ECM

The Threat Indicator is out. You won't be able to detect incoming MiGs unless they show up on your Radar screen, assuming it's functioning. You may have to make visual contact. Make it through this and the Sierra Hotel may be your permanent home.

BURNER

The Afterburner cannot be invoked. This will eliminate quick acceleration, which could make the difference in completing a maneuver successfully or making a quick getaway.

RADAR

The Radar display is inoperable. You will have to rely on the ADI and visual contact to orient yourself to the horizon, and you'll be severely limited in how well you can track a MiG on the screen.

ENGINE

Signifies a partial or complete loss of power to your F-16. If you're not able to maintain any altitude or momentum, the power loss is complete, and you'll have to eject.

HUD

When this light is on, you'll probably know it already, because the HUD glass will be blank. At this point, you have to rely on visual sighting and the backup gauges in the main cockpit and side views to survive. It's probably a good idea to turn tail and head for home, if you can.

FUEL SYS

Signals a leak in the Fuel System. Watch the Fuel Gauge closely to monitor the severity of the leak. If your gauge starts to drop quickly, head for home immediately, and prepare to eject if necessary.

NAV

Indicates that your Map is not functioning properly. The map grid will be displayed on the COMED screen, but your relative position is not shown.

OXY LOW

Indicates a drop in cabin pressure, usually caused by a bullet hole. Don't fly above 27,000 ft or you're certain to black out, even if flying straight and level.

Part III: Military Ranks and Missions

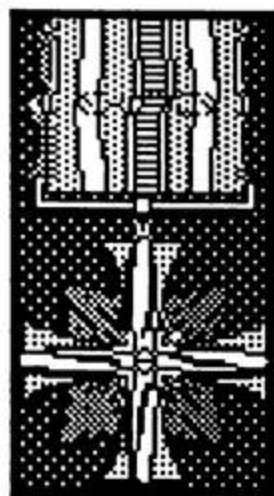
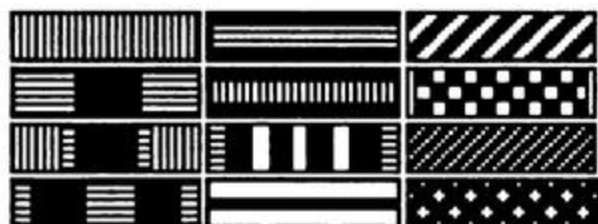
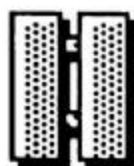

The Ranks

The difficulty levels in **FALCON** are determined according to military rank. The classifications include **First Lieutenant** (lowest) and continue through **Captain, Major, Lieutenant Colonel, and Colonel** (highest). The ranks determine not only your plane's characteristics but the nature of the enemy as well. The charts on pages 98 and 99 summarize what the nature of play will be at each of the ranks: first for you and your F-16, and then following for the enemy. Most of the rank guidelines are self-explanatory. For example, your F-16's flight performance and restrictions become more "true-to-life" as rank increases, making the simulation more challenging. The MiG opponent and SAMs also become more formidable.

At First Lieutenant level, the program's realism is dampened a bit so you can easily become involved in the game and get a taste for most of its features. Playing as a Colonel will give you a highly realistic experience and require you to be very skillful to survive. However, just as the experience will become more exciting and dramatic, the rewards will also be more substantial at the upper levels. For example, it will be possible to receive certain medals and merits only at higher ranks. A detailed look at the scoring and awards process is included later on in **Part III**.

Super Engine vs. Normal Engine

At First Lieutenant and Captain rank, **FALCON** has what we call a "super engine". Airspeed is directly related to the percentage of RPM applied, and no other factors are involved. This engine output is easier for you to gauge because extraneous factors like climb rate are not considered. In other words, you can initiate a nose dive at 50,000 feet going 500 knots and when you hit the ground, you'll still be going 500 knots if you haven't increased or decreased the throttle with RPM percentage. *This engine also does not stall.*

Weight and Drag Influence from Armament

At Lieutenant Colonel and Colonel ranks, the type and amount of weapons and accessories that you carry on your F-16 will definitely affect its performance. Your plane won't be able to pull as many g's, and certain maneuvers may render the plane uncontrollable. The F-16 is a terrific machine, but all jets have limitations.

Ground Crashes

As rugged as a jet fighter seems to be from an outward appearance, their landing mechanisms are somewhat delicate. Become adept at the takeoff and landing procedures before flying at high ranks, because your landing gear cannot take a lot of abuse. You won't necessarily have a fatal outcome from a faulty landing (or even a belly flop!), but your superiors and the taxpayers won't be too excited.

Possible Outcomes After Pilot Ejection

Since **FALCON** isn't *exactly* real life, you don't have to worry about not making it through an ejection sequence at lower ranks. However, at Major level or above you risk being captured by the enemy if you bail out behind enemy lines. The probability increases the further behind enemy lines that you eject. **In **FALCON**, being taken Prisoner of War (POW) is a permanent condition.** (*If you crash behind enemy lines, you are declared **MIA**, or **Missing In Action**.*) Plus, fighter pilots know that ejection even in friendly territory doesn't necessarily lead to a safe trip home, because of possible complications from the ejection itself. *Ejection should be treated as a definite last resort at upper ranks.*

Possibilities of Pilot Blackout or Redout

Modern fighter jets can perform some pretty amazing maneuvers and still retain their structural integrity. Now, if the same was only true for their pilots! Even with advances in flight suits and cockpit design, there are still limits to what a pilot's body can withstand from the force of high-speed turns.

At Major rank or above, you risk pilot "**blackout**" if your plane sustains a maneuver in excess of **8 g's**. The excessive force crams the pilot into the seat and pushes his blood supply downward. You'll know you're in trouble because the screen will start to fade out before going completely black. (A pilot loses the ability to distinguish colors during the initial stages of a blackout, producing in effect a "whiteout".) **Part IV** discusses high g forces, which are usually the result of sharp and climbing high-speed turns.

Blackouts are the result of "positive" g forces. Equally as dangerous are "**redouts**", which are caused by pulling "negative" g forces. Negative g's are a result of pushing the stick forward into a dive too fast and for too long. The blood rushes to a pilot's head as he effectively gets "pulled" from the seat, and this time the screen will go progressively "black", signifying the darkening effect from the blood pressure on your eyes. On the average, the human body cannot withstand a negative g force in excess of **-2.5 g's** before experiencing a "redout", and possible rupture of blood vessels in the upper body.

Pilots say that even when blackout or redout occur, they can still recover from it and regain control of their senses. What you must do in **FALCON** to recover from these kinds of situations is to try and remember what the most recent event sequence was that got you in trouble. When the blackout or redout starts to occur, move in the opposite direction (or at least stop the current action). You should recover from the dilemma, assuming all your other ducks are in a row, so to speak.

FIRST LIEUTENANT	CAPTAIN	MAJOR	LIEUTENANT COLONEL	COLONEL
Lowest		Difficulty		Highest
Easier to Fly		Ease of Flying		Harder to Fly
Easy to Hit MiG		Accuracy of Gun Bullets		Hard to Hit MiG
Super Engine			Normal Engine	
No Engine Stall			Engine Stall Possible	
Unlimited Armament	Limited Armament (No Weight and Drag Influence)		Limited Armament (Full Weight and Drag Influence)	
Unlimited Fuel		Limited Fuel (Must Monitor Fuel Usage)		
No Collisions Possible		Collisions Possible with Ground Structures (Fatal Collisions!)		
No Ground Crash	Ground Crash if Angle > 60°		Normal Ground Crash	
Ejecting Pilot Always Lives and Returns		POW Possibility if Eject Behind Enemy Lines	POW or Fatal Outcome Possible After Ejecting	
	Unlimited Flares		Normal Limit on Flares (30)	
Unrestricted Landing and Take-Off	Must Raise and Lower Landing Gear	Full Landing Gear and Nose Wheel System Requirements for Landing and Take-Off		
No Pilot Blackout or Redout		Pilot Blackout or Redout Possible		

Effect of Rank on You and the F-16

FIRST LIEUTENANT	CAPTAIN	MAJOR	LIEUTENANT COLONEL	COLONEL
No MiG Missiles or Guns	No MiG Missiles; MiG Gun Bullets Not Very Accurate	MiG Missiles and Guns are Somewhat Accurate	MiG Guns are Very Accurate; MiG Missiles are Somewhat Accurate	Both MiG Missiles and Guns are Very Accurate
No MiG Flares		MiG Flares Exist, But Not Totally Effective	MiG Flares are Totally Effective	
	Only One MiG Onscreen at Any Time; Can Force to Zero on Intro Screen		Two MiGs Maximum Onscreen at Any Time; Can Force Downward on Intro Screen	Three MiGs Maximum Onscreen at Any Time; Can Force Downward on Intro Screen
No SAMs of Any Kind	SAMs Launch, But Don't Strike You	SA-2 Radar-Guided SAMs Only	SA-2 Radar-Guided and SA-7 Heat-Seeking SAMs	SA-6 Radar-Guided and SA-7 Heat-Seeking SAMs

Effect of Rank on the Enemy

The Missions

FALCON contains a variety of air-to-air and air-to-ground missions to test your flying skills. All missions take place in a landscape arena consisting of enemy territory as well as a "friendly" area where your airfield is located.

The individual mission descriptions will detail where you need to fly and how you need to perform the mission to be successful. The following map of the **FALCON** landscape gives an overall view of what the arena looks like, with the locations of individual SAM sites, bridges, airfields, and other landmarks noted.

Your **COMED** screen in the cockpit toggles to show a reduced-size version of the map, to assist in reaching your target. Even more important, it helps you get back home.

In addition, your navigation computer has data on the locations of targets for the various missions. Each target has been assigned a number (called its **waypoint**). This waypoint number is displayed in the lower right side of the HUDs, along with the current distance from that target. For example, the first building in the mission "Milk Run" has waypoint **D1**. When you are fifteen miles from this target, the waypoint indicator will be: **15D1**.

You may change the waypoint number. Key ";" increases the number; Key "0" decreases it. If you engage the autopilot, **FALCON** will head directly for the current waypoint (unless there's a MiG in the vicinity).

Note: Home Base has a Waypoint of D0.

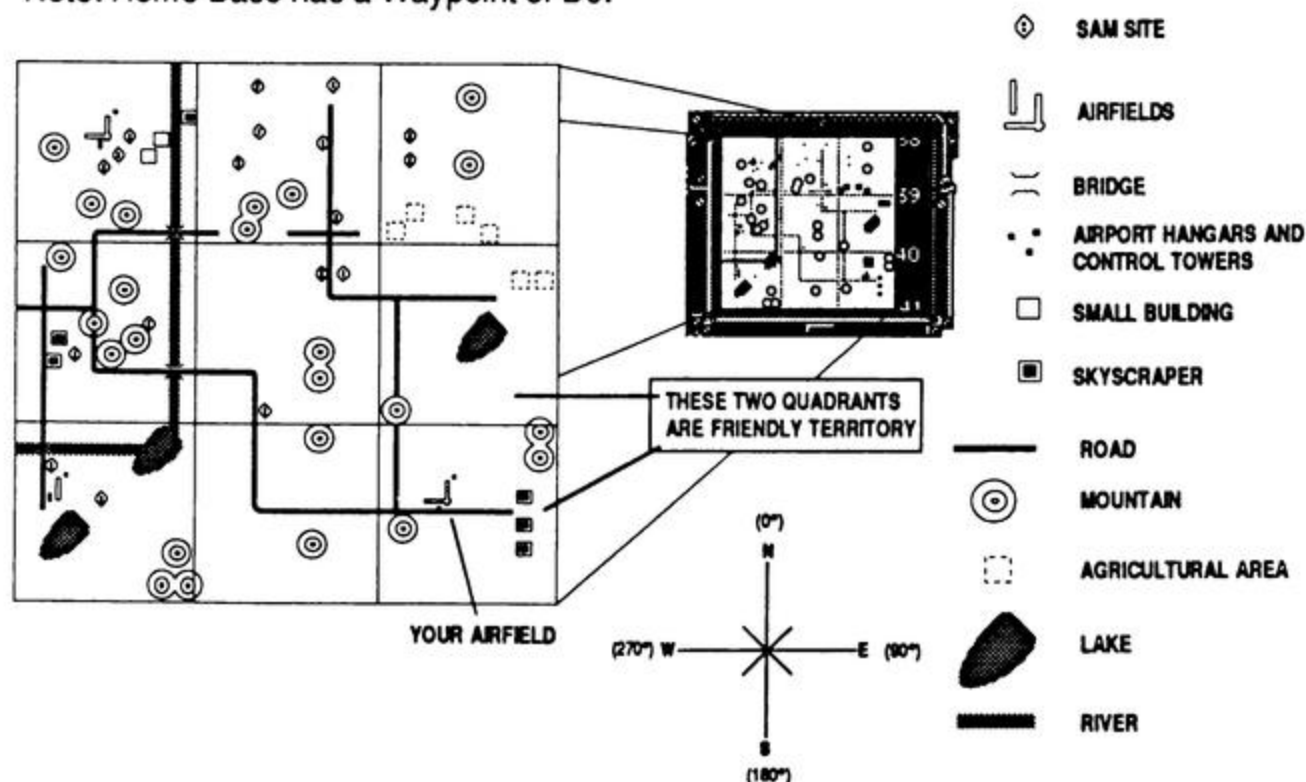

Milk Run



WAYPOINT: D1-D3

BUILDINGS

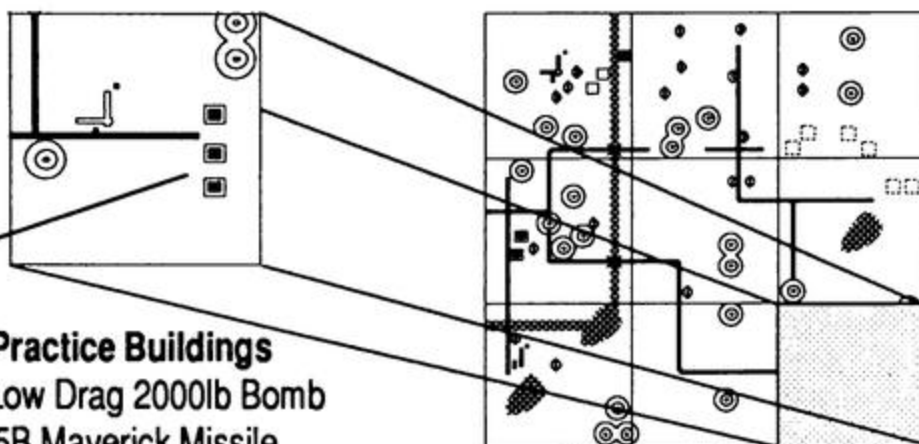

Objective: **Bomb Practice Buildings**
 Effective Weapons: Mk 84 Low Drag 2000lb Bomb
 AGM-65B Maverick Missile

- *Every rookie pilot needs a confidence builder and flying the Milk Run should do just that. Use this mission to become familiar with both the Mk 84's and the AGM-65B Maverick's delivery systems. The Milk Run is also an excellent choice for improving takeoff and landing skills.*
- *Veterans enjoy flying the Milk Run. It gives them a chance to improve their skills and explore the outer edge of the F-16's flight envelope, otherwise known as "chasing demons". Use this opportunity to get familiar with the way your plane flies at higher skill levels.*
- *Food for thought: Many pilots have "bought the farm" while flying the Milk Run because they were too busy showing off and hotdogging. Stay alert!*

Black Bandit

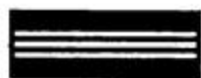

WAYPOINT: D12

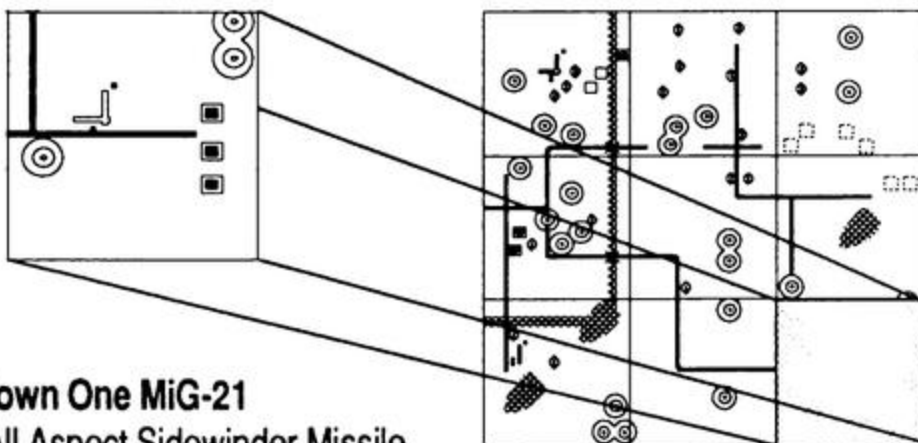

Objective: **Shoot Down One MiG-21**
 Effective Weapons: AIM-9L All Aspect Sidewinder Missile
 AIM-9J Sidewinder Missile
 M61A1 Gun

- *The Black Bandit has been creating havoc for months. He's the enemy's best pilot and today he's up, circling and challenging your base to send up their best. Well kid, here's your chance to prove how good you really are.*
- *Keep your eyes open. If you find yourself in a bad situation, get out of it. Don't try to play hero. Take your best shot first. The Sarge may be able to help out by getting you some AIM-9L All Aspect missiles. You'll have a fighting chance to take him out with a head-on shot using these. They're hard to come by, but if the Sarge can get some, use them.*
- *The Bandit will come in from due north of your airfield. Good luck, you're going to need it.*

Rattlesnake Roundup



WAYPOINT: D13

Objective: **Destroy Three SAM Sites**
 Effective Weapons: Mk 84 Low Drag 2000lb Bomb
 AGM-65B Maverick Missile
 M61A1 Gun

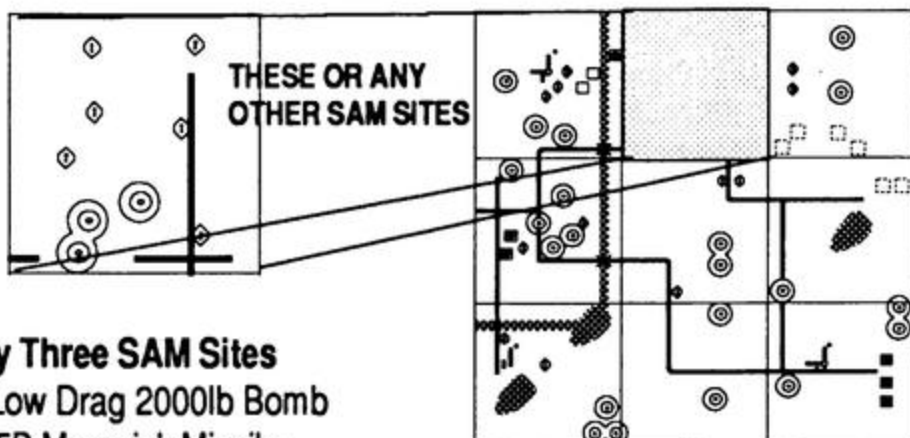

- Your commander has just gotten word that Strategic Air Command is going to resume high altitude night bombing. The biggest threat to them are the enemy's SA-2 and SA-6 surface-to-air missiles (SAMs). You have to start knocking out the SAM sites anyway you can. To complete your mission, you need to destroy a minimum of three SAM sites.
- Use your Mk 84s, Mavericks, or M-61 to take 'em out. If you can get the Sarge to let go of an ALQ-131 jamming pod, it might make your life easier at Major's rank or higher. The pod will jam the SAM's guidance system, and increase your life expectancy.

Double Trouble



WAYPOINT: VARIOUS

Objective: **Shoot Down Two MiGs**
 Effective Weapons: AIM-9L All Aspect Sidewinder Missile
 AIM-9J Sidewinder Missile
 M61A1 Gun

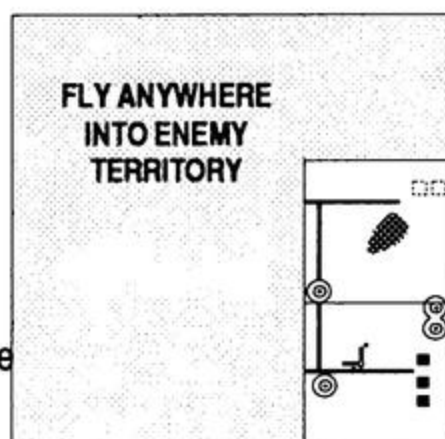

- The enemy is hopping mad and sending up two of their best pilots to pay you back for all the trouble your base has caused them behind enemy lines. They are patrolling in their area and waiting for you to return. However, once you cross into enemy territory, they may not appear right away. They like to jump you when you least expect it. Keep your eyes open and monitor the Radar screen and Threat Indicator.
- Rookie pilots tend to make one particular mistake during multiple engagements that all too often turns out to be fatal. They become obsessed with chasing one bogey and forget about the others. MiGs like to work in tandem. One plays the carrot, the other plays the stick . . . a very big stick that loves to smash you from the rear.
- Load your plane with as many AIM-9Ls and AIM-9Js as possible, because you're going to need them. Keep an eye on your fuel gauge. Gas is gold. Afterburner provides needed power in a dogfight, but costs an enormous amount of fuel. You can add drop tanks if you want to increase loitering capability, but be prepared to eject them before going into battle.

Dragon's Tail



WAYPOINT : D4

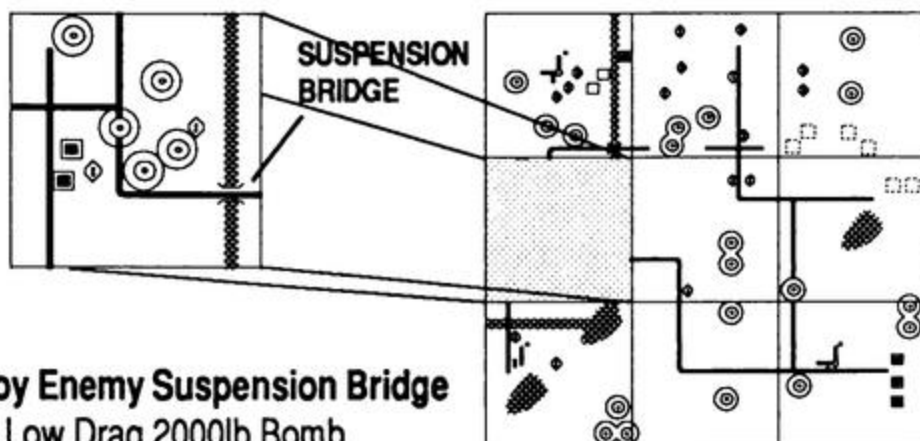

Objective: Destroy Enemy Suspension Bridge
Effective Weapons: Mk 84 Low Drag 2000lb Bomb
 AGM-65B Maverick Missile

- *One principle of war is to deny enemy access to supplies by cutting off their lines of transportation. Knocking out the southside bridge is critical to your side's success in controlling the enemy. Use Mavericks or Mk 84s to take out the bridge.*
- *Since you'll be flying over enemy territory, you must keep your eyes open for either MiGs or SAMs. There's one SA-2 or SA-6 site just southeast of the bridge along the main highway. Also, if you're flying at Lieutenant Colonel or Colonel rank, be prepared for lots of SA-7 shoulder launch specials trying to nail you if flying below 10,000 feet.*

Dragon's Jaw



WAYPOINT: D5

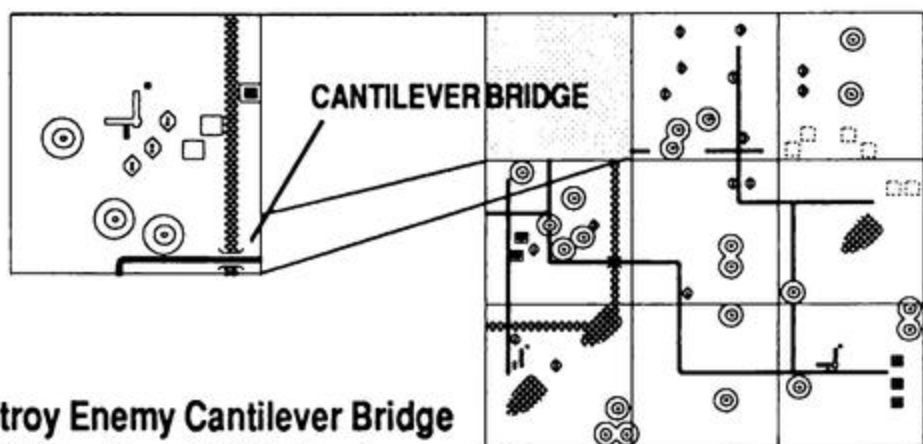

Objective: Destroy Enemy Cantilever Bridge
Effective Weapons: Mk 84 Low Drag 2000lb Bomb

- *The Dragon's Jaw has been an elusive target for your squadron. Early on, planes have tried 1000lb'ers and Mavericks to take out the bridge, but they just seem to bounce off or scorch the paint. Arm your plane with the 2000lb Low Drag bombs. Try to avoid any dogfighting while you have any of these fat bombs dangling from under your wings, as the plane wasn't designed to dogfight with a full load.*
- *Plan your mission carefully, avoiding SAM sites and MiGs until you deliver your package to the Dragon. If the enemy engages you and forces you to dump your load prematurely, the MiGs will have already won the battle before the first shot is fired.*

Hornet's Nest



WAYPOINT: D6

Objective: **Destroy Enemy Runway**
 Effective Weapons: Durandal Anti-Runway Bomb

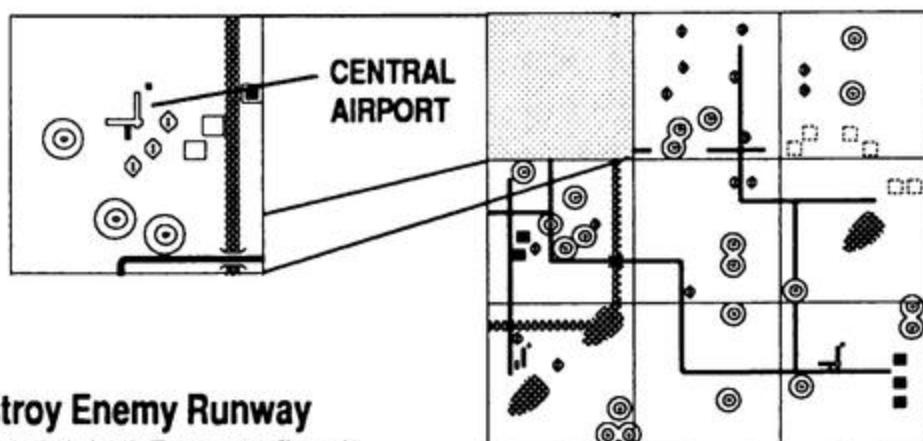

- Denying the enemy use of their runway will severely cripple their ability to harass your planes. Your job is to knock out the Central Airport with the Durandal Anti-Runway weapon by hitting the airfield where the two runways intersect.

- Extra fuel tanks will help extend your flight time, giving you the luxury of engaging the enemy after delivering your load. An ALQ-131 is also recommended to protect you from SAM launches. This airport is heavily protected by SAMs and MiGs.

Bear's Den



WAYPOINT: D7

Objective: **Destroy Enemy Communication Center**
 Effective Weapons: Mk 84 Low Drag 2000lb Bomb
 AGM-65B Maverick Missile

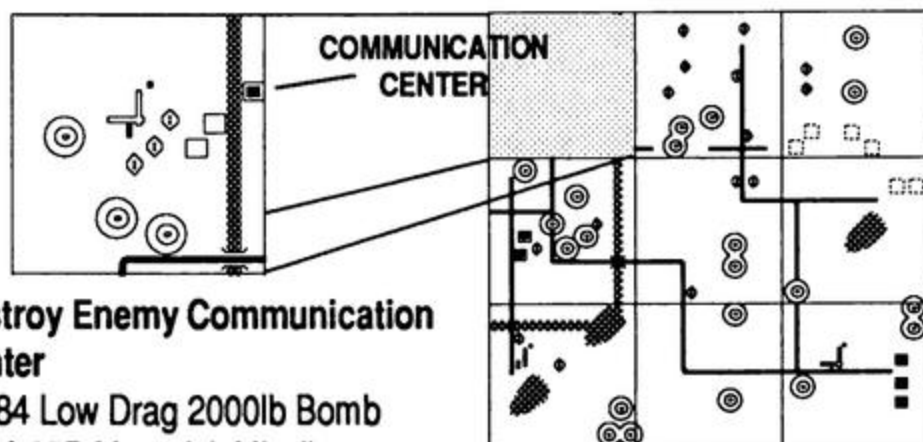

- The enemy's communication center handles all their logistics and coordinates all attacks. Operation Bear's Den requires you to destroy this hotbed of activity. The center is well protected by SAMs. Shoot at the building's base to blow it up. We recommend that you come in low and fast, deliver your weapons, and get out of there as fast as possible. Don't loiter around and become MiG chicken feed.

Venus Flytrap



WAYPOINT: D8-D9

Objective: **Destroy SAM Sites by Regional Airfield**
 Effective Weapons: Mk 84 Low Drag 2000lb Bomb
 AGM-65B Maverick Missile
 M61A1 Gun

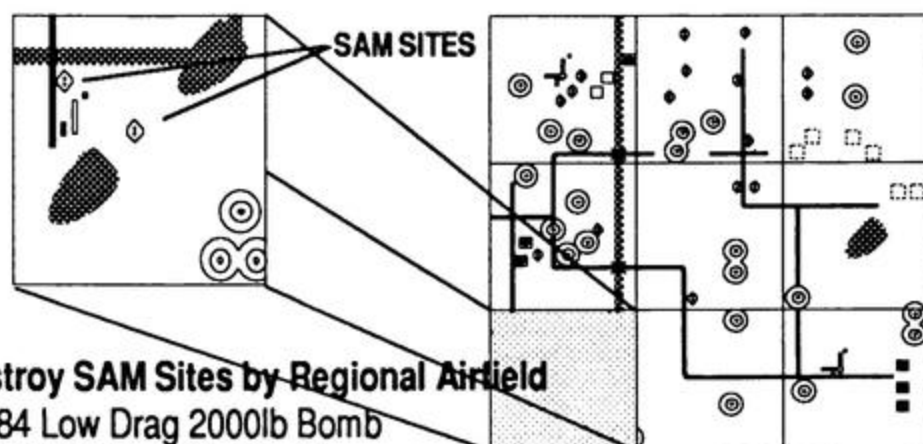

- *Within 24 hours, Strategic Air Command will launch a major strike to totally destroy the enemy's Regional Airfield. Before they can launch, you must destroy both SAM sites protecting the airfield. SAMs or MiGs will be up. The Flytrap is heavily protected and the enemy doesn't take too kindly to those wanting to bomb them. If you're shot down, there's a very low probability of being rescued.*
- *Like other bombing missions, avoid engaging any MiGs until you've accomplished your primary objective. If you're successful at eliminating the SAM sites and have enough weaponry left over to take out the airfield for SAC's benefit, they will appreciate it very much. However, you will have to decide at the time whether it's worth the extra risk.*

Strike Palace



WAYPOINT:
D10-D11

BOTH
BUILDINGS

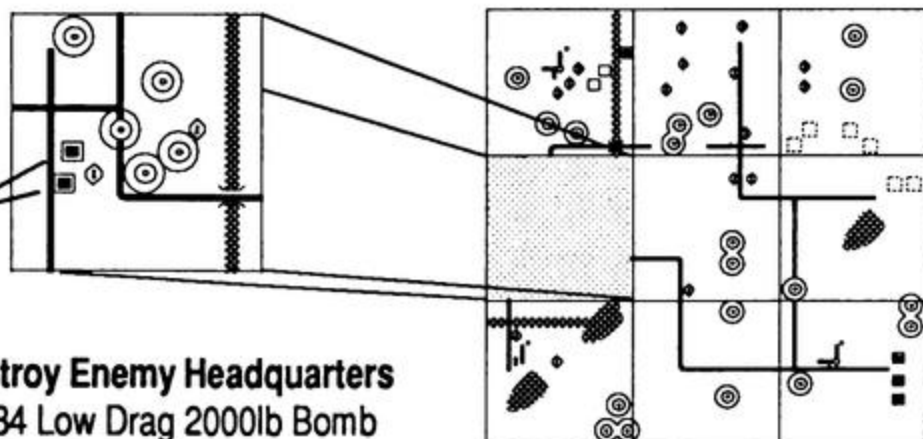

Objective:

Destroy Enemy Headquarters

Effective Weapons:

Mk 84 Low Drag 2000lb Bomb
AGM-65B Maverick Missile

- *Enemy headquarters is located due north of the Flytrap and nestled in a valley beneath the foothills. Attacking their headquarters will deliver a blow to enemy morale as well as eliminate a key communications center. You need to destroy both buildings to achieve your goal.*
- *Take an ALQ-131 and beware of the SAM site adjacent to the headquarters buildings.*

Double Dragon

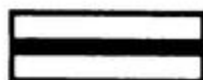

WAYPOINT: D4, D5

BOTH
BRIDGES

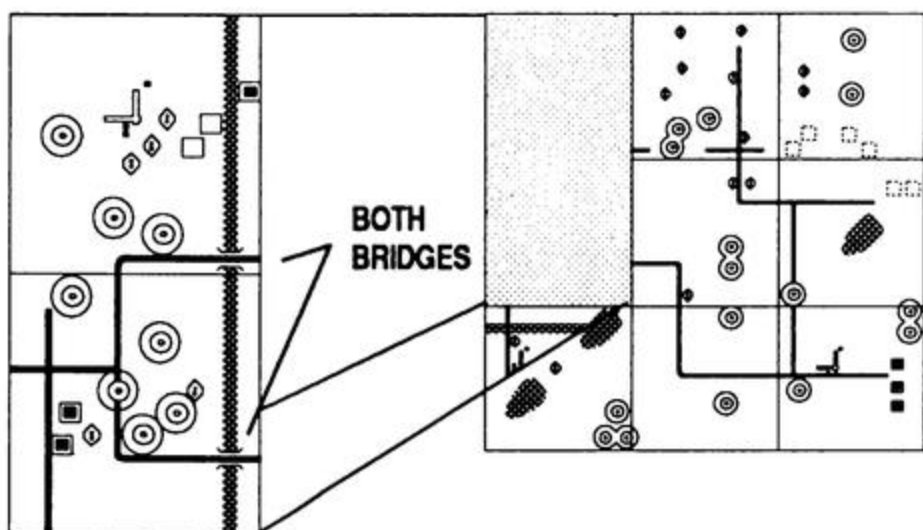

Objective:

Destroy Both Suspension and Cantilever Bridges

Effective Weapons:

Mk 84 Low Drag 2000lb Bomb
AGM-65B Maverick Missile (Suspension Bridge only)

Every time we cut off one of their bridges, the enemy simply reroutes the flow of traffic to another bridge. Your task in Operation Double Dragon is to destroy **both** bridges.

The Double Dragon is no cake walk. It requires that you load up your plane heavily, fly deep into enemy territory, and destroy both bridges. Because of armament restrictions at any rank other than First Lieutenant, missing the Cantilever Bridge once means that you've failed in your mission. You wouldn't have enough weaponry to try a second run and still have enough bombs or missiles for the Suspension Bridge. Completion of this mission means you're one hot pilot.

Grand Slam



WAYPOINT: VARIOUS

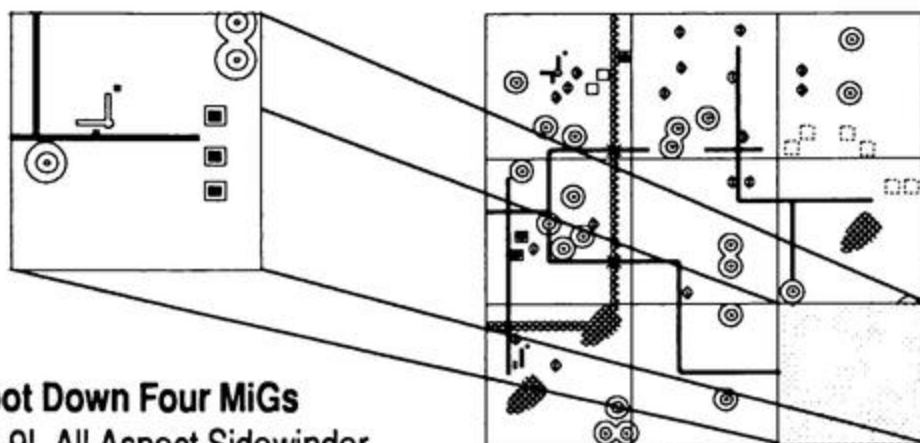

Objective: **Shoot Down Four MiGs**
 Effective Weapons: AIM-9L All Aspect Sidewinder
 AIM-9J Sidewinder Missile
 M61A1 Gun

The situation is critical. Intelligence has confirmed that the enemy is planning a full scale assault on your base **today**. Your job: do the impossible, which is to intercept and destroy at least four MiGs. **Note:** Incoming MiG heading is unknown.

Mission Results: Snapshots, Awards, and Merits

At the end of a mission, press the "Esc" key to bring up the **Menu Bar** and select "End Mission" from the **File Menu**. You'll see a special Awards screen that contains information related to the mission that was just flown. Hopefully, your completed mission will include a successful landing, and would be the most desirable way to reach this screen. However, you might not complete your mission. Even if you do, you may not make it back to your home base for one reason or another. If you crash, eject, or otherwise have your mission cut short, this screen will appear automatically after the mishap. A series of snapshots may be displayed, along with a record of any merits (points) or medals earned during the mission. After you're through observing the Awards screen, click the mouse to move on to the Sierra Hotel screen which displays the current "top ten" list of pilots.

Snapshots

You may see a series of snapshots that describe the events leading up to the completion of your mission. Let's take a look at some of the snapshot sequences and see how you should interpret them.



MISSILE HIT



EJECT



GOOD "CHUTE"



RESCUED

This is a typical missile hit sequence. Frame number 1 shows that an enemy missile slams into your plane. Frame 2 displays an ejection sequence as the canopy is jettisoned. The parachute opens cleanly in frame 3 and frame 4 shows the big bird coming to save you for another mission.



CRASH LANDING



A SORE NECK



COURT-MARTIALED!

Here's what happens if you mess up! Forgetting to lower your landing gear, travelling too fast down the runway, or taking off in the grass, you'll quickly find yourself facing a court-martial.



PLANE IS HIT



UNCONTROLLABLE
SPIN



EXPLOSION
AND CRASH

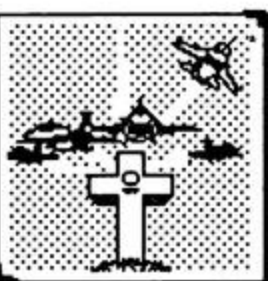

FUNERAL AND THE
MISSING MAN

This is an example of "buying the farm". Engine fire . . . You black out and go into an uncontrollable spin . . . then the unthinkable happens. BOOOM! Crash and burn. In the end, your section flies the "missing man formation" paying their final respects to you.

Decorations and Medals

The armed forces recognizes acts of heroism by decorating its members with medals. There are five medals that you can be decorated with during your service as a **FALCON** "driver". These medals are awarded at the completion of each mission where sufficient merit has been displayed.



Purple Heart

The Purple Heart decorates any member of the Armed Forces that is injured in action. The first Purple Heart decoration issued was a simple silk or cloth purple heart trimmed with white lace. Today's medal has a profile of George Washington in a field of purple.

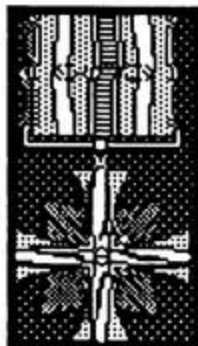

Distinguished Flying Cross (DFC)

The Distinguished Flying Cross (DFC) is given to pilots in recognition of their outstanding achievement or heroism while flying. This medal was first awarded to Charles Lindbergh by President Coolidge for Lindbergh's historical crossing of the Atlantic in 1927.

To qualify for a **DFC**, you must:

1. Successfully complete Dragon's Jaw, Dragon's Tail, Hornet's Nest, Bear's Den, Double Dragon, or Strike Palace **without using an ALQ-131 pod**. You must also fly at **Major's** rank or higher, **OR**
2. Successfully complete Dragon's Jaw, Dragon's Tail, Hornet's Nest, Bear's Den, Double Dragon, or Strike Palace; **plus engage and destroy two or more MiGs**. You must also fly at **Major's** rank or higher.

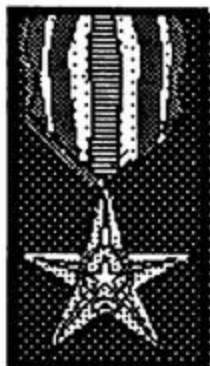

Silver Star

This medal was authorized in 1918 for the purpose of decorating armed forces members who performed acts of heroism and gallantry against an armed enemy. It is awarded for those acts not great enough to merit the Medal of Honor or the Distinguished Service Cross.

To obtain a **Silver Star**, you will have to successfully complete one of the following missions: Rattlesnake Roundup, Dragon's Jaw, Dragon's Tail, Hornet's Nest, Bear's Den, Double Dragon, or Strike Palace **without an ALQ-131 jamming pod**. **Destroy two or more MiGs in a simultaneous engagement**. You must also **bomb your primary target and a secondary target**. You must fly at **Major's rank or higher**. A second way of receiving a Silver Star is to destroy **four or more MiGs at Major level**.

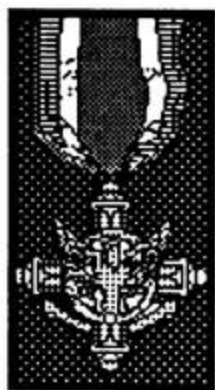

Air Force Cross

The Air Force Cross was established by Congress in 1960 and is awarded only to those individuals who have performed outstanding acts of heroism against armed enemies in a hostile environment.

In **FALCON**, the Air Force Cross has the same requirements as the Silver Star with two exceptions: you must fly at **Lieutenant Colonel or Colonel rank**, and **return the F-16 safely to your home base**.



Medal of Honor

The Medal of Honor, sometimes called the Congressional Medal of Honor, is the highest award in the nation and is presented by the President of the United States. The Medal of Honor is given to those members of the Armed Forces who perform acts of gallantry "above and beyond the call of duty" against overwhelming odds and against an armed and hostile enemy. The history of this medal dates back to 1861 when Congress first authorized it for the Navy. The medal bears the head of Minerva, the Roman goddess of war.

Only by flying at **Colonel level** are you eligible for the Medal of Honor. You need to **shoot down a minimum of three MiGs in at least one simultaneous engagement**. Also, **bomb a primary and secondary target without an ALQ-131 ECM Pod** in any of the following missions: Dragon's Jaw, Hornet's Nest, Bear's Den, Strike Palace, Double Dragon or Grand Slam.



Ribbons

Ribbons are awarded for successfully completing the objectives of any mission. **Returning your plane**

safely to the base is always important but is *not* a requirement for receiving a ribbon. In the U.S. Armed Forces, an "oak leaf" is presented instead of a ribbon, if the particular ribbon has already been received for previous success in a similar situation. The number to the right of the ribbons represents the number of oak leaves you have received since first appearing on the roster.

MiG Kills

The program will automatically tally the total number of MiGs you've shot down since your name first appeared on the Duty Roster list.

Bomb Hits

Bomb hits record the total number of targets that you've successfully destroyed since first appearing on the Duty Roster.

Merits

This represents the number of merits (points) you earned during your flight. The merit system awards points based on the difficulty of the mission and what you've accomplished.

MISSION**MERITS**

Milk Run	1	<i>You will receive one additional merit point for every target that is bombed.</i>
Black Bandit	2	
Rattlesnake Roundup	2	<i>Two merits are given every time you shoot down a MiG.</i>
Double Trouble	3	
Dragon's Tail	4	
Dragon's Jaw	6	<i>Two merits are awarded for executing a safe landing.</i>
Hornet's Nest	10	
Bear's Den	10	
Venus Flytrap	12	
Strike Palace	12	
Double Dragon	15	
Grand Slam	15	

RANK MULTIPLES

The Wing Commander will multiply your merits by a rank factor.

Captain	merits x 2
Major	merits x 3
Lt. Colonel	merits x 4
Colonel	merits x 5

There is no multiplying factor for First Lieutenant, as it is the initial rank.

BONUS MERITS

If a pilot manages to stay alive and complete all twelve missions, the Wing Commander awards an additional 3000 merits for being one hot pilot.

MEDAL MERITS

Purple Heart	1	Air Force Cross	60
Distinguished Fly Cross	15	Medal of Honor	200
Silver Star	30		

SIERRA HOTEL

This special screen lists the top ten pilots who have ever played from your disk; "the best of the best". This list may include pilots who for one reason or another are out of commission, but their scores are still impressive enough to remain in the top ten.

File REM Scenery Control Options

SIERRA HOTEL			
Rank	Pilot	Status	Merits
COLONEL	BADGER	ACTIVE	4320
CAPTAIN	RED BARONNESS	MIA	4009
CAPTAIN	LOBO	RETIRED	3244
COLONEL	CHOPSTICK	ACTIVE	2246
COLONEL	SNAKE	ACTIVE	2246
MAJOR	MAD DOG	ACTIVE	1953
COLONEL	REBEL LEADER	ACTIVE	1125
LT COL.	MAN-EATER	ACTIVE	1087
MAJOR	BULLDOG	BUSTED	603
MAJOR	COPPERHEAD	KILLED	522

- Click the mouse or QuickStick button to return to the Duty Roster. From there, you can start another mission or exit the game.

IMPORTANT!

Make sure that you go back to the Duty Roster screen before exiting, to insure that your pilot's cumulative score, rank, etc., will be updated properly. Just as with all applications, you should exit the program properly. (Don't just turn the switch off.) Plus, remember that just to be safe, you should "Quit" after playing

Part IV: Advanced Fighter Training

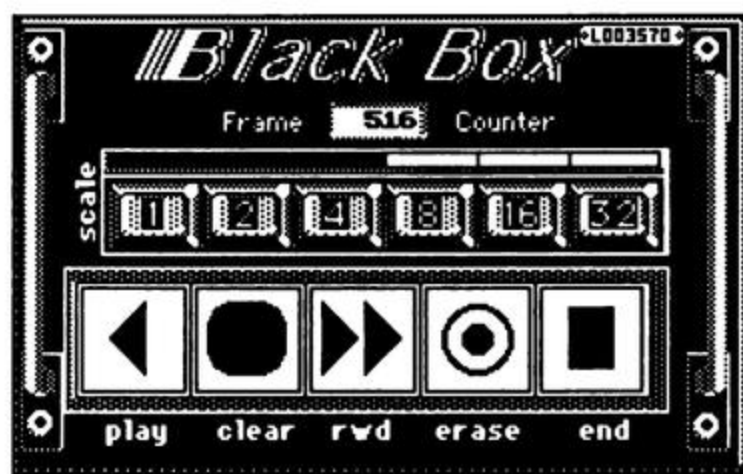
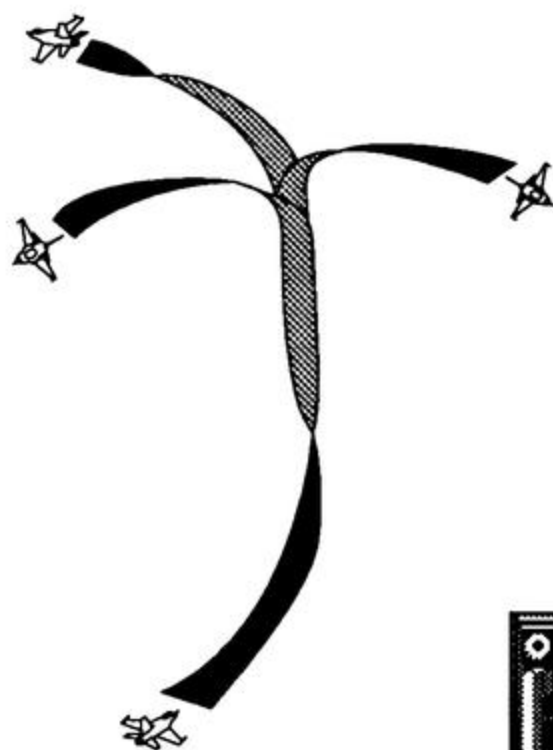

General Flight Performance of the F-16

The Nature of G Forces

The key to a jet being a good Air Combat Maneuvering (ACM) aircraft is in its ability to "pull g's" (also called "turn g's"). G's represent the force of gravity that is being applied to the plane and its pilot, and is commonly called "centrifugal force". G's dictate how fast and how tight a plane can turn at any given speed. *All other things being equal, the plane that can turn the fastest usually wins the battle.*

The effects of g forces on aircraft and pilots must be understood by anyone entering the air combat arena. Strictly speaking, a force of 1g is equal to the force exerted by gravity on a body "at rest". When a jet is flying straight and level, the lift generated by the plane's wings offsets its weight, to the point that both plane and pilot are experiencing a gravity force equal to 1g. This is equivalent to what you might feel while walking along a level street. Since increasing units of g forces are used to indicate the *increasing* force to which a body is subjected when accelerated, a higher "positive" number of g's represents a higher force of gravity. Decreasing positive numbers (even to the point of being negative) signify a *decreasing* force of gravity. Whenever you pull your nose into a turn or a climb (by pulling back on the stick or increasing your bank angle), you'll pull an increasing amount of positive g's. You've probably seen the centrifuge used in astronaut training that tests a person's ability to withstand centrifugal force. Whirling a person around in a circle at increasing speeds is very similar to what a pilot feels in a banking turn, and many of these turns are performed almost instantly. You begin to appreciate not only the pilot's ability to withstand the force, but the plane's as well. *Pushing the stick forward results in pulling less or even negative g's, as you're not opposing the force of gravity anymore per se.*

Positive g's push a pilot into the seat. At 7g's, your body experiences 7 times the gravitational force than normal. This means that your 25 pound head weighs 175 pounds! At forces greater than 9g's, there is so much pressure that the blood stops flowing in your head, causing you to black out. A **blackout** results in a loss of vision or even passing out completely.

On the other hand, negative g's cause the blood to be *forced* into your head. Your body and plane can tolerate many more positive g's than negative g's. Excessive negative g's (greater than -3) cause the blood vessels in your eyes to rupture. This is commonly referred to as a **redout**, which is equally as dangerous as a blackout.

The F-16 is the first jet fighter specially designed to withstand a 9g load. Before the F-16 arrived on the scene, the typical fighter could only tolerate a maximum of 7g's, *thus giving*

the F-16 a 2g advantage over older aircraft such as the MiG-21. Still, a word of caution should be noted since between 1982 and 1987 at least ten American F-16's crashed due to pilot blackouts. In addition to pilots giving out during high g maneuvers, planes also fail. In 1985, an F-15 pilot pulled his plane into a high g climb with a full load of missiles and external tanks, causing his plane to go out of control and disintegrate. *You should take special note of this, especially if you're flying with a Cat 3 load (carrying any external stores other than AIM 9 missiles). Planes are restricted to 5.5 g's and cannot fly inverted with a Cat 3 load.*

Let's examine how much g forces play a role in your turn radius. The following is a comparison of turn radii at different g forces.

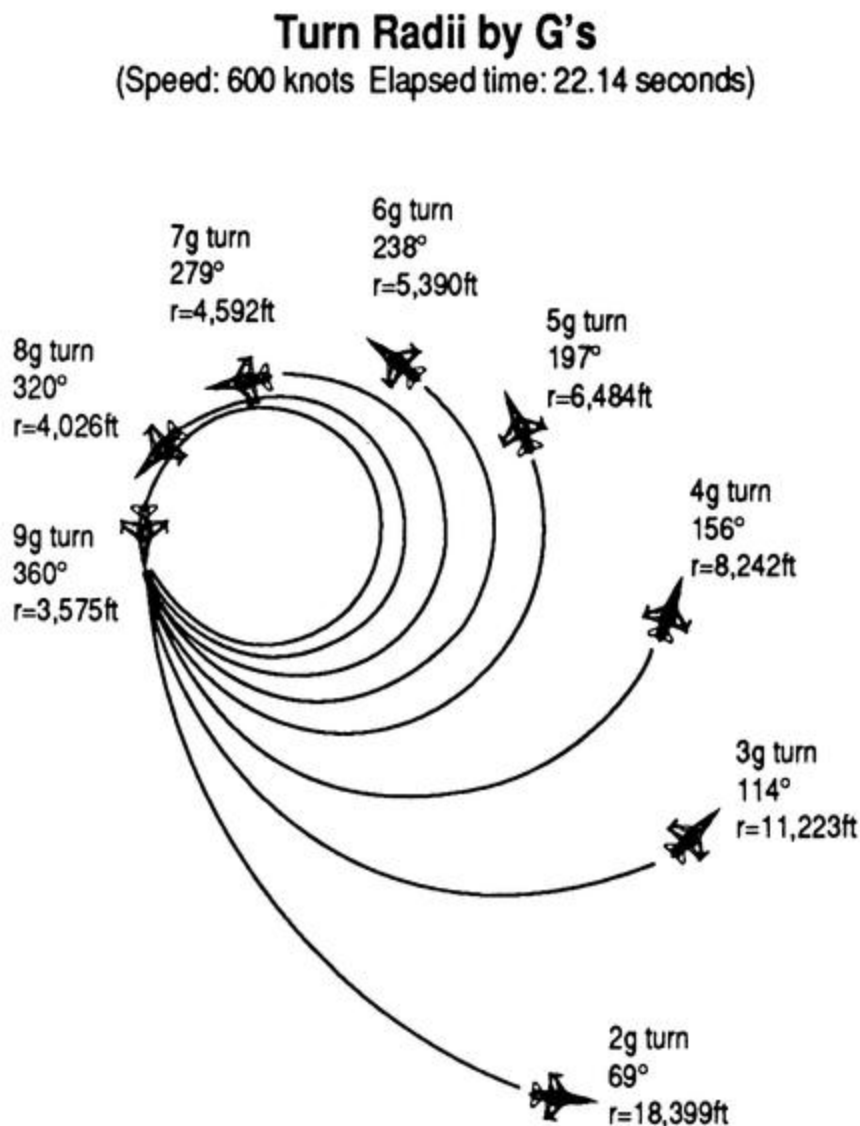

A plane travelling at 600 knots and pulling a 9g turn will have completed a full 360 degrees, whereas a plane traveling at the same speed pulling a 2g turn will have only completed 69 degrees of its turn.

Another major factor that affects the rate of turn and size of turn radius is speed. Take a look at the following diagram. It compares planes pulling the same amount of g's but travelling at different speeds. A plane traveling at 200 knots pulling 4g's will have a turn radius of 912ft and will have fully completed a turn in 17.15 seconds, whereas a plane travelling at 1,000 knots will have a turn radius of 22,885ft and would have only completed 72 degrees of its turn in the same amount of time.

Turn Radii by Speed

(4g turn Elapsed time: 17.15 seconds)

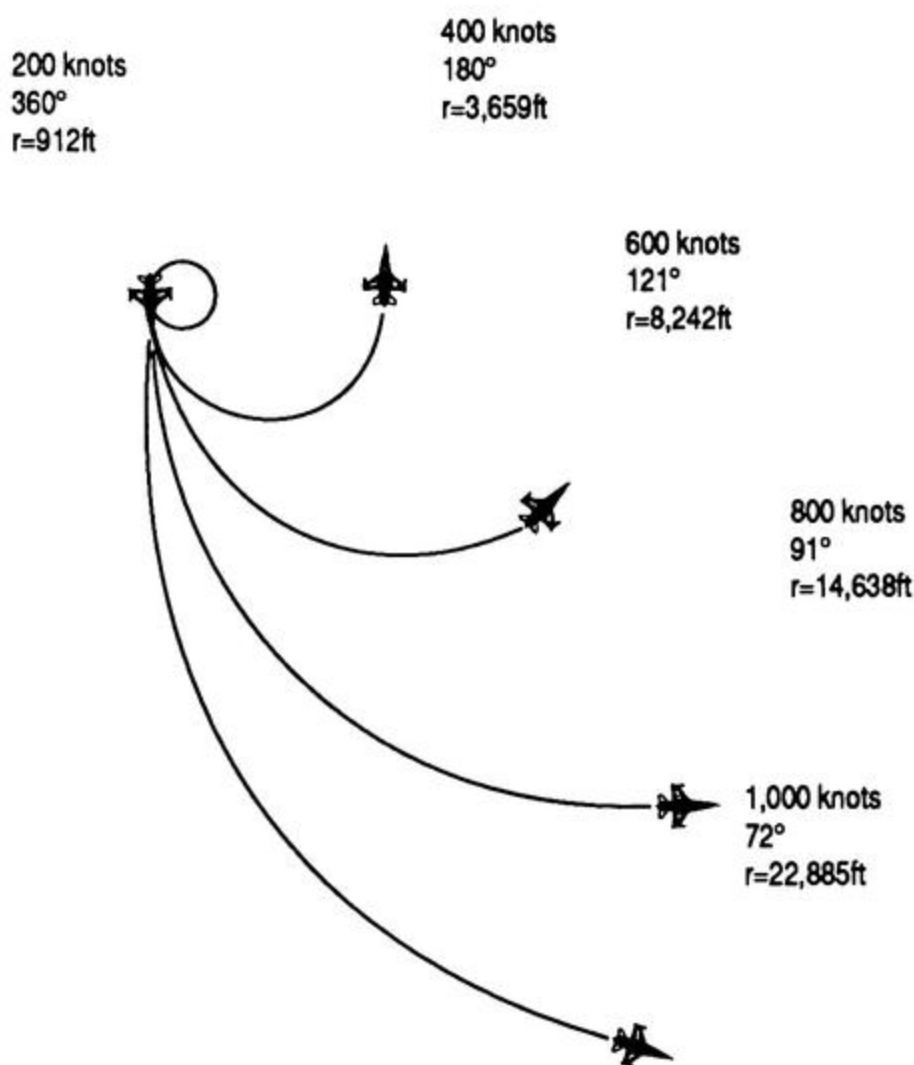

The ability to pull g's is dependent upon a plane's flight performance envelope. Flying beyond the envelope (chasing too many demons too far) can result in a stall or total loss of control of your plane. The two constraining factors that limit your flight envelope are altitude and speed. The Flight Performance Envelope Chart below illustrates the sustained performance limitations of the F-16. Your F-16 might be able to exceed these curves for brief

moments of time without incident but we don't think General Dynamics will honor any warranties if you push the envelope too far and crash and burn your aircraft.

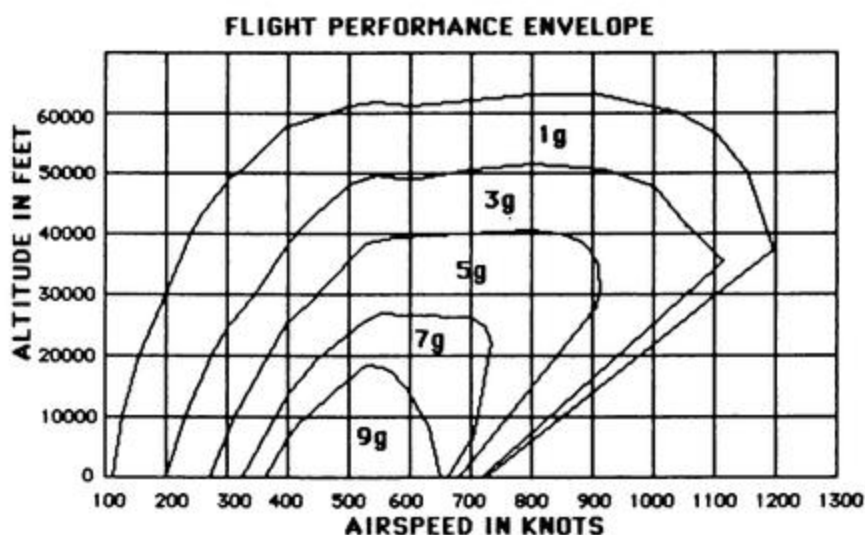

Keeping Your Energy High

A common mistake made by rookie pilots is flying their aircraft either too slow or too fast.

Those flying their planes too slow are under the false assumption that slower speeds result in tighter turns and advantage during high-g ACM environments. *Pulling high g's bleeds off (reduces) airspeed.* Note in the Flight Performance Envelope chart that flying too slow results in lower g capabilities. Pulling g's can force your F-16's airspeed to fall below the stall rate, resulting in an uncontrollable dive. **Remember:** *Speed is energy. Energy helps you get in and out of battle. Running out of airspeed (the same as running out of energy) is no fun in the heat of battle.*

On the other hand, rookies have been known to carry this too far and attempt to dogfight travelling at Mach 2 (over 1,000 knots per hour). Trying to maneuver at Mach 2 is like trying to control a rocket that has gone ballistic.

As with everything else in the world, there is a happy medium. *Most dogfights occur between 500 and 700 knots. This is the optimum speed for high g maneuvers as well as maintaining a high energy state.*

How to Pull Out of a Stall

Learning how to pull yourself out of a stall can be a lifesaving matter. Flying beyond your plane's performance envelope can result in a stall. **If you're flying too fast and trying to pull too many g's, all you have to do is relax off the stick.**

Stalling because you've lost too much airspeed is a completely different matter. You can convert altitude into energy (airspeed) by going into a dive until you've built up enough airspeed and control before pulling out. Pulling out too soon or too hard can result in another stall so we recommend that you dampen your controls (at upper ranks) by using Trim Control as you pull out of the dive.

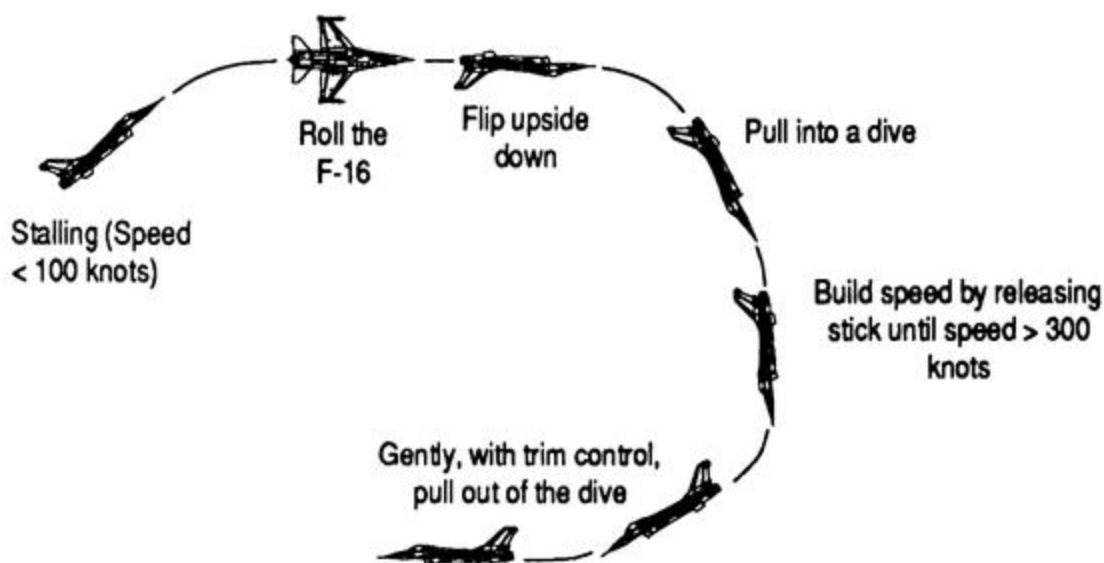

How to Pull G's

Pulling and pushing on your stick controls turn radius and g forces. Banking your plane at steeper angles results in an increase in g forces and a decrease in turning radius. Pulling back on your stick will **add** additional g's. Pushing forward will **subtract** g's. *Turns with excessive g's (more g's than are required to maintain an angle of bank) will pull the plane into a higher angle of climb. Turns made with less than the required g's will cause the plane to drop.*

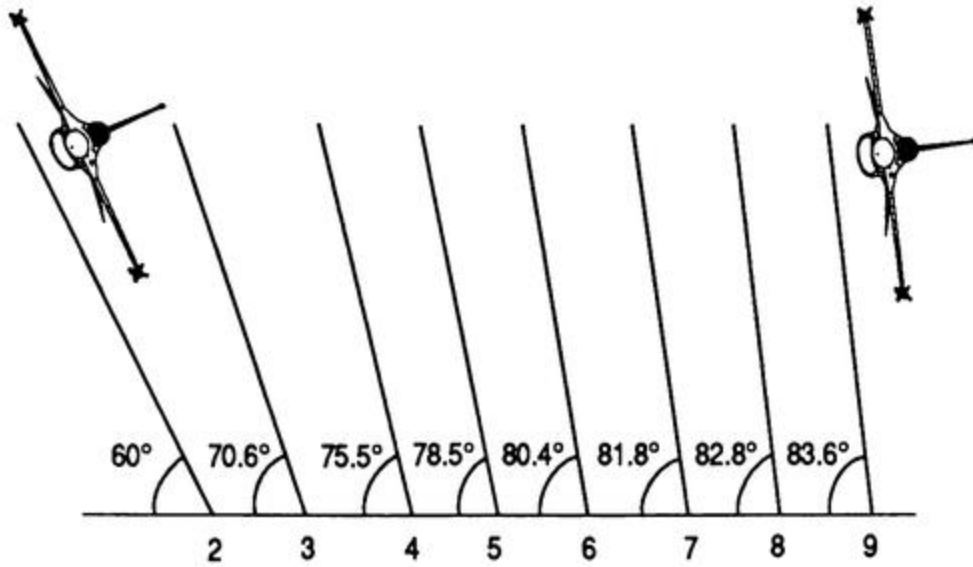

Required G Forces to Maintain Bank

Pulling Negative G's

Your F-16 is capable of pulling up to 3 negative g's, though you'll start to "red out" if you exceed -2.5 g's. To pull negative g's, push your stick all the way forward.

Inexperienced pilots will initiate a dive by pulling negative g's. A better approach is to roll your plane upside down and pull positive g's toward the ground. Using this technique, you'll use both gravity and the higher positive g capability of your F-16 to go into a faster dive.

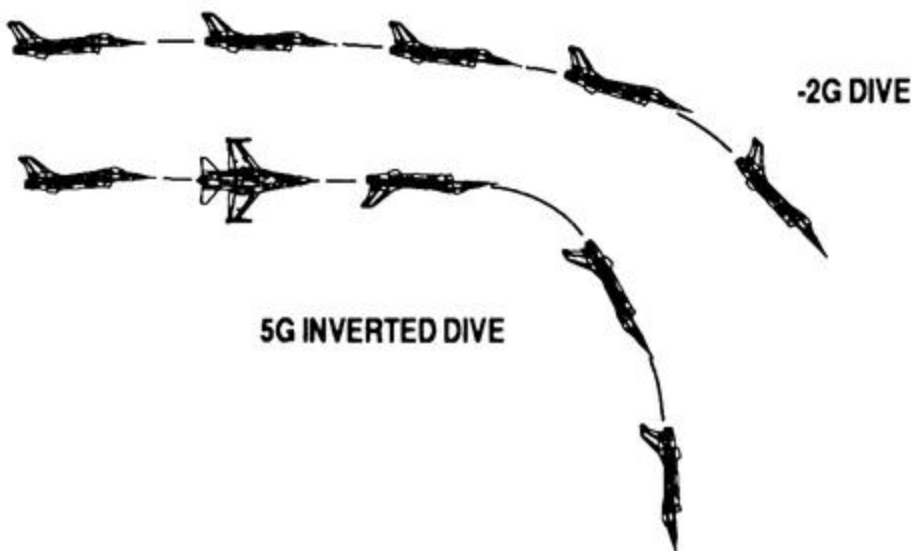

Fuel

Fuel is the life blood of your plane. Planning your missions properly is as important as flying them. The weight of your plane, its altitude, and whether or not you are using afterburner or full military power are all factors in determining how much fuel is used in the mission. The following chart shows how much fuel your plane is consuming (pounds per second) based on altitude. Two plots are shown: one for afterburner, and the other for 100% military power.

FUEL CONSUMPTION CHART

based on a gross weight of 25,000lbs during normal conditions using 100% RPM

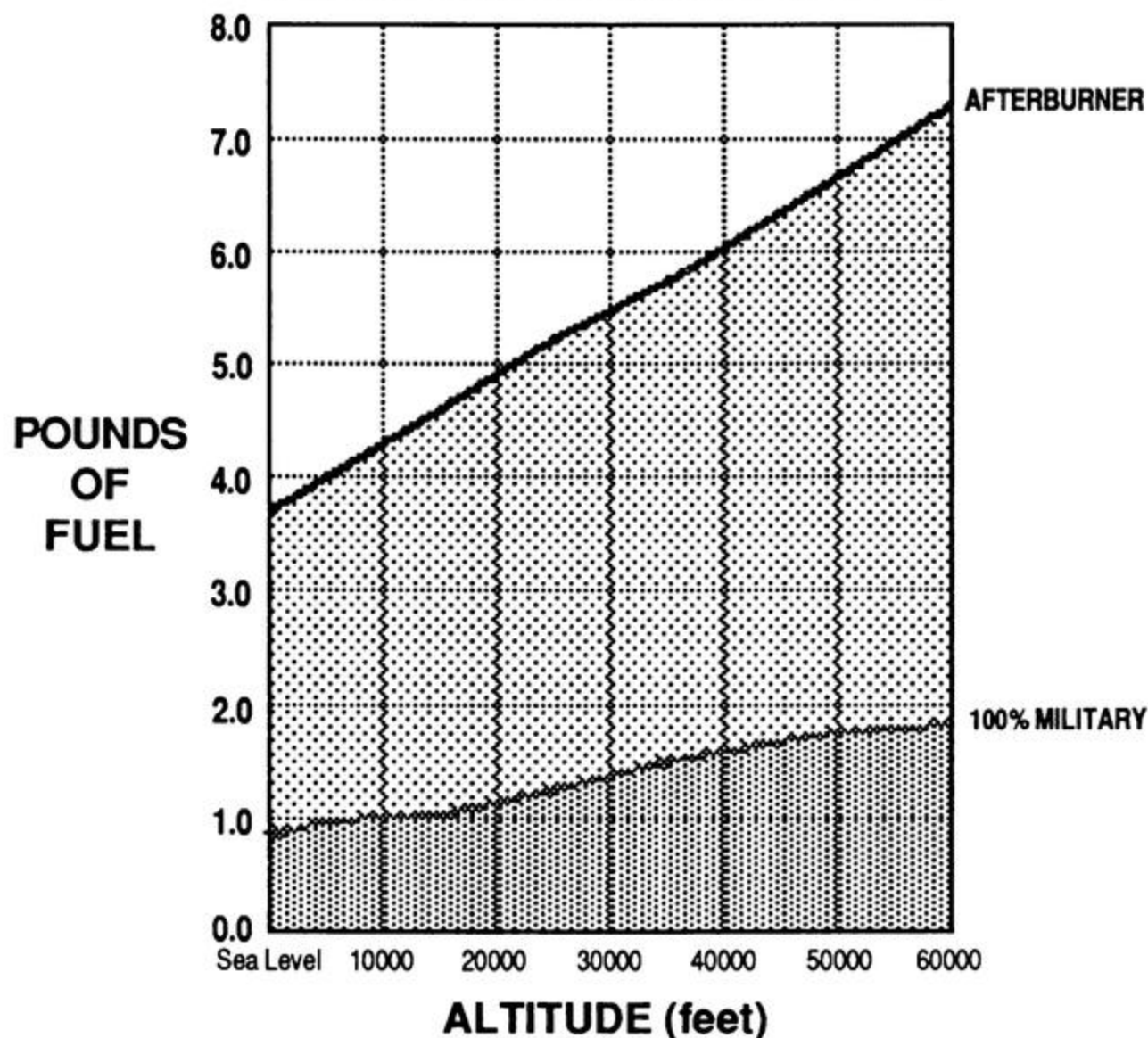

*Fuel consumption based on a standard PC averaging 4 frames per second

Note that the use of afterburner burns four times the fuel as military power. Essentially, an engine lights an afterburner by spraying fuel out the back of the engine. Also, notice how much altitude plays a role in fuel consumption. These are important factors to remember, especially if you try to make it back to home base with very little fuel remaining.

If you are carrying any external tanks of additional fuel, remember that fuel is drawn from these tanks first before the internal capacity is used. The main internal tank will automatically switch in once all the fuel from the external tanks has been exhausted.

Check your Fuel Gauge on the left cockpit panel to make sure the needle for any external tanks is at "0" (zero). *At this point, you may jettison your external tanks (Control-C) to reduce weight and drag, and therefore increase your F-16's maneuverability, stability, and acceleration.*

One more statement on high g turns:

When you make hard-turning maneuvers at the upper levels of the program, expect your plane to "bleed off" (decrease) airspeed in the process. This may or may not be a desired effect. If you don't want this to happen, increase RPM to 100% and/or kick in the afterburner to minimize the effect as much as possible.



Take good care of our bird.

Air Combat Maneuvers

Fighter pilots have to rove in the area allotted to them in any way they like, and when they spot an enemy they attack and shoot them down . . . anything else is rubbish.

BARON VON RICHTHOFEN

To be successful in the fighter business the air crew must, first and foremost, have a thorough background in fighter tactics. They must acquire an excellent knowledge of all their equipment. Then they must approach the problem with a spirit of aggression and with utter confidence.

LT. R.S. LORD
ROYAL NAVY

We agree with the Red Baron that a good pilot is more important than any plane. However, if he had lived to see the agility of modern-day jet fighters, he might have changed his tune about the simplicity of air combat. Being aggressive isn't the only prerequisite to success in dogfight battle today. Rather, the pilot must be well trained in air combat maneuvers, and apply an aggressive behavior to the fighting situation in light of his particular fighter's capabilities.

The superior agility of the F-16 enables the pilot to perform maneuvers that have been impossible in the past. In the same light, its superior capabilities can create such stress on the pilot that its agility can create a problem in itself. For example, the plane's ability to pull 9g's in a matter of three seconds enable it to turn in an incredibly tight arc. However, as you've already learned, that same capability will cause most pilots to black out in the process. At the upper levels of the simulation, **FALCON** is true to the F-16 in this respect. You must remember that the pilot and plane are working together, and following any series of maneuvers precludes that you, the pilot, know exactly what your plane can do and work in harmony with it.

The maneuvers that we will be discussing are standard ones employed by fighter pilots throughout the world. By clicking on the ACM menu you can practice all these maneuvers in safety. By choosing an appropriate view option you can act as a spectator.

Engage

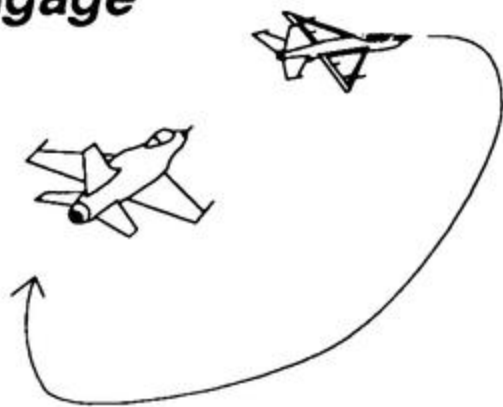

This is a basic offensive maneuver, where the MiG will try to do anything in order to move in on your "six"; in other words, move in for the kill.

Break

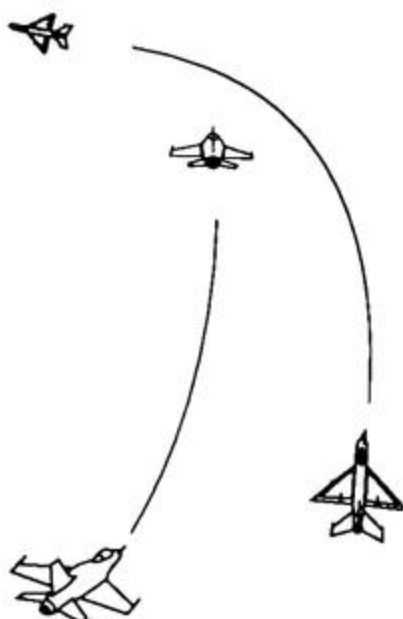

The classic defensive maneuver. When a plane is attacked from the rear, it turns hard into the pursuer's line of attack in an attempt to make the attacker overshoot. The F-16's excellent turn rate can help you "beat the break" often. Conversely, you are able to elicit a pretty fair Break maneuver yourself, if you ever need to (and you will!).

Scissors

This maneuver results from a successful Break by the plane under attack. As the attacking plane overshoots its target, the other plane tries to turn the tables and move in behind the previous attacker, and both planes roll and crisscross the other's path as each tries to gain the advantage. Your F-16 has an inherent advantage over the MiG-21 in this maneuver because of its better turning characteristics, but the MiG pilot is very skilled. The Scissors can remain in a stalemate for a relatively long period of time, until one plane takes the initiative and bails out or initiates another maneuver.



Variable Scissors

This move is a variation of the more classical Scissors maneuver shown above. Rather than simply making rolling reversals in a relatively flat trajectory, both fighters do a bit of diving and climbing while reversing in and out of each other. This maneuver is very unlikely to end up in a stalemate, because of the numerous changes in position.

High G YoYo

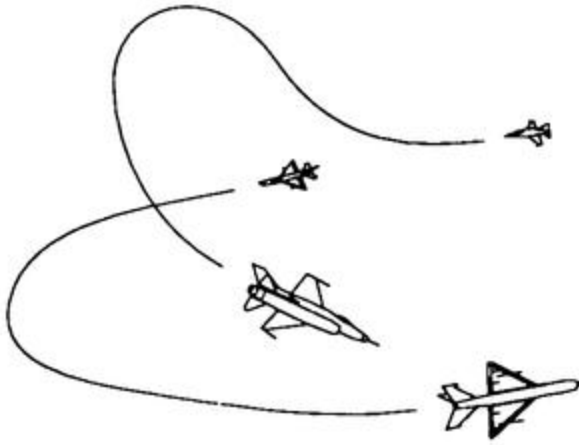

The High G YoYo is an offensive maneuver that is a reaction to the "Break". Because the attacking plane is unable to hold position with the plane that is "breaking", it starts to pull less of a hard turn and moves vertical as well. During the climb, it rolls in the general direction of the predominant turn, so it can make an aggressive dive at the breaking plane from what is now a more favorable position. Like the Immelmann, this maneuver is an example of using a vertical move to enable your plane to change position in less of a horizontal plane than a more conventional turn. If this maneuver is performed precisely, it can be very effective because the other "breaking" plane will find it hard to detect your position. However, if you combine an ineffective turn with inadequate speed in the climb, the other plane will have plenty of time to move away.

Low G YoYo

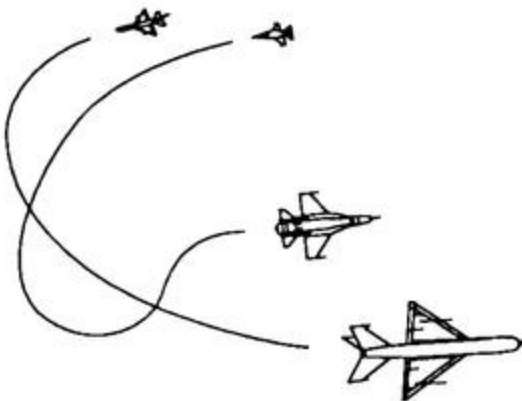

This maneuver basically takes the opposite approach than the High Speed YoYo to resolve a stalemate with a "breaking" plane. Rather than go vertical, the attacking plane goes into somewhat of a dive while maintaining as much of the turn as possible. The attacking plane then pulls up behind the other plane in a more favorable position. Don't dive too low or overturn, because the other plane will probably roll in behind you.

Flip YoYo



This is a slight variant from the Low G YoYo. Rather than do a pure dive and risk pulling too many negative g's, roll your plane after initiating the dive. You'll also be able to pick up speed faster in this move than the more conventional Low G YoYo. Take care to not overshoot the other plane because of excessive speed buildup.

Lag Pursuit



When a plane under attack makes a "Break", the tendency is for the attacker to overshoot. Sometimes though, the attacker is able to maintain its advantage by performing the Lag Pursuit, where the favorable position is held slightly behind and below the path of the target plane. Besides being able to match the target plane's turn rate, the attacking plane is able to prevent overshooting by occasionally pulling g's in a slight climb to bleed off speed.

Split S

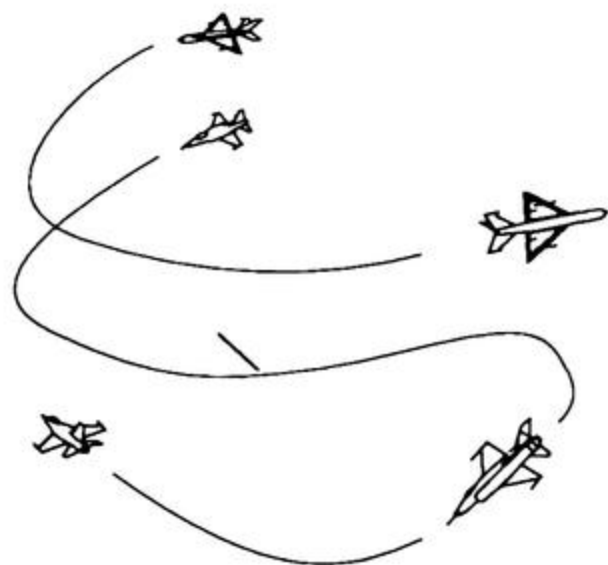

The Split S is a defensive maneuver that comes as a result of the attacking plane moving in too close. The target plane will roll upside down and pull into an accelerated dive before the attacking plane can react. The important thing is to do the half-roll before you dive, so you'll pull positive g's when you initiate the dive. You'll accelerate better and your body will withstand the stress better (remember negative g's).

Head On

The classic confrontation, where unless either plane has been lucky enough to strike the other on the way in, the advantage is gained by the plane that can turn on the tighter arc to overtake the other. Because it's difficult to guess which way the adversary is going to turn after passing you, most pilots get used to looking over their shoulder to check on the opponent's next move, even while they're making their own.

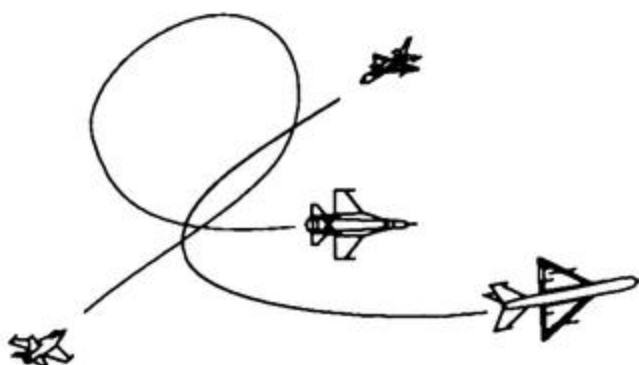

Rollaway

This maneuver is similar to the High G YoYo discussed earlier. The main difference is that the attacking plane rolls *in the opposite direction of the predominant turn* before making its dive to regain advantage.

Vertical Loop

The Vertical Loop is used as an evasive maneuver. In its purest form, you pull into a sharp climb and simply come over the top and continue in the same direction. You may be able to pull in behind the other plane. Otherwise, since the loop is relatively easy to perform, you can use it as a decoy while setting up another maneuver to execute immediately after coming out of the loop.

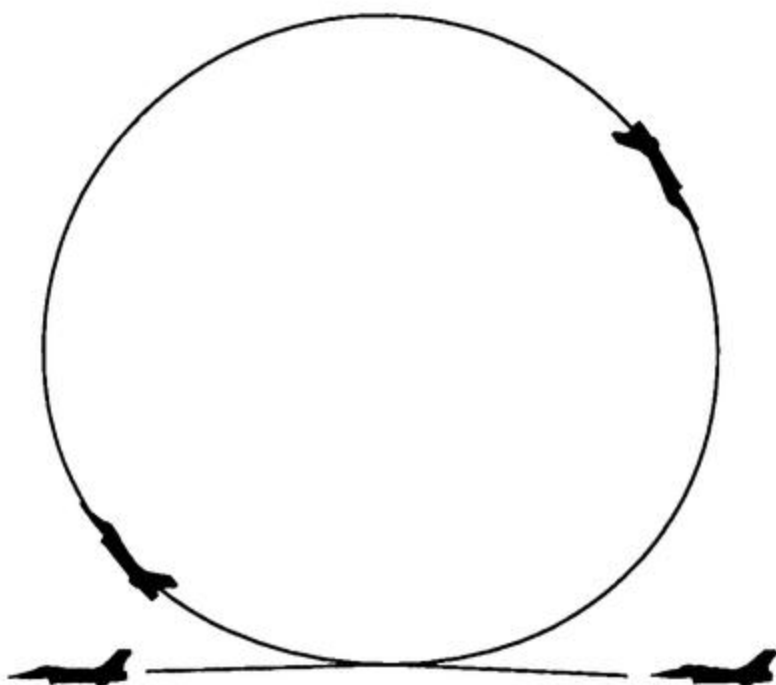

Immelmann

The Immelmann is a defensive maneuver where the plane being chased is trying to change direction in the least amount of horizontal area by rolling in a vertical climb, rather than by using the more conventional turn on a flat plane. Your F-16 is one of the few jets in the world capable of performing this move adequately, and you will find it very useful in battling the MiG. A hard vertical climb is followed by a roll into whatever direction you wish to go at the top of the climb. Because you don't have the same instinctive orientation to the ground during this maneuver, use the Flight Path Ladder to determine your directional relationship to the ground.

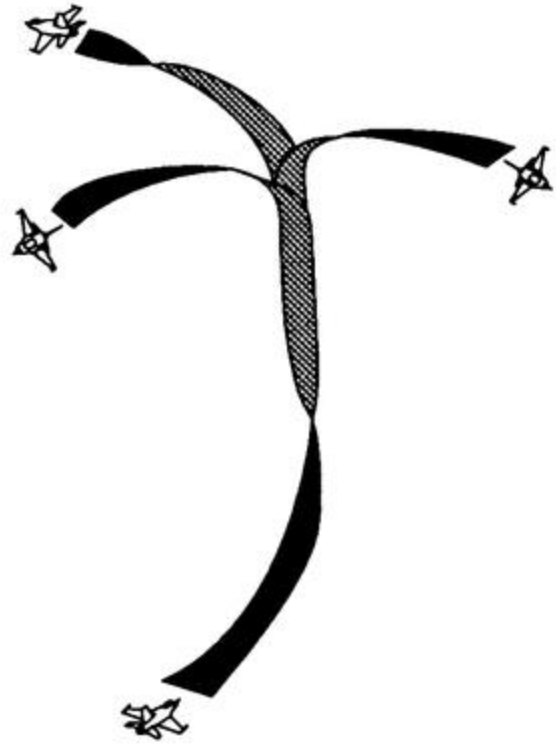

Dive Loop

The Dive Loop is a good maneuver to perform when you are being trailed by a pursuer that is still a relatively long distance away. As is the case in some of the other maneuvers, you have a more efficient turn because of the vertical emphasis. Plus, it's more difficult for your pursuer to tell what you're doing, since there is no movement on the horizontal plane of sight. The key is to do a half-roll (**invert**) as you initiate the dive, so as to pull positive g's, initiate better acceleration, and achieve a tighter turn radius.

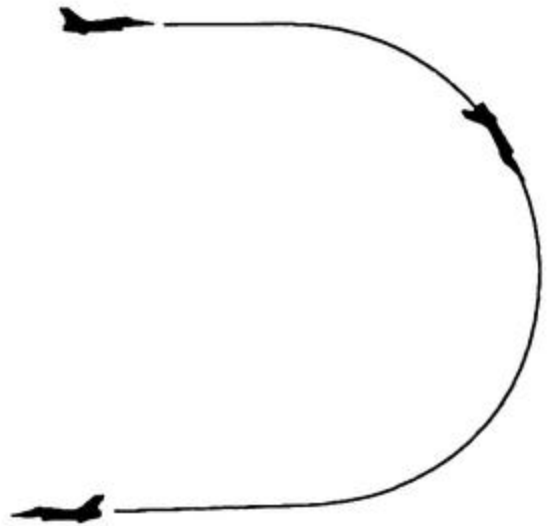

The Black Box

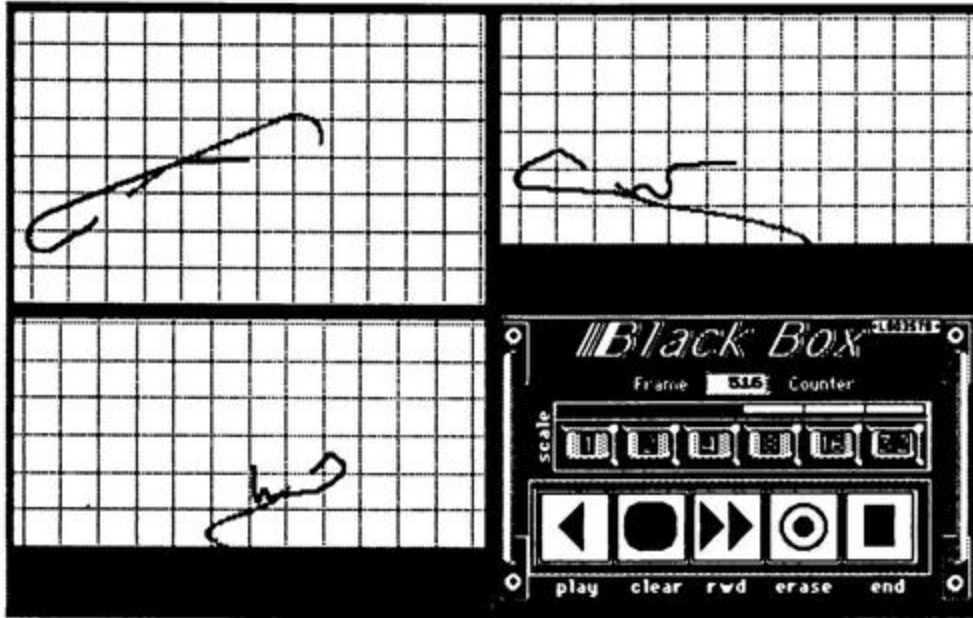

This feature is only available on 1 MB models of the ATARI ST and Amiga.

FALCON contains a **cockpit flight recorder** (commonly called a "Black Box") that records your F-16's **flight path** (and the same for any MiGs in the area) over a period of time. It's primarily designed for these purposes:

- To show an "instant replay" of a MiG encounter, so you can analyze your performance in dogfighting the enemy plane;
- To play back any of your flight paths (whether practicing air combat maneuvers or just messin' around) so you can get a different view of what your plane is doing.

You can invoke the Black Box (with the **Control-B** key combination) at any time after you're inside the plane; or during the Awards screen, if you want to see the sequence of events that led to the end of your flight (whatever the outcome!).

Your F-16's path is represented by a **green** colored line while any MiG paths appear as **red** lines. Any MiG that appears on a Black Box trail is picked up via one of two ways: either because it showed up on your Threat Indicator, or your ground support crew's electronics picked it up and communicated the data through to your recorder.

As the next example shows, it keeps track of the flight path from three different views: 1) **looking down on the path from directly above**, 2) **ground level looking from west to east**, and 3) **ground level looking from south to north**.

The Black Box starts recording from the moment you enter the cockpit and remains on for

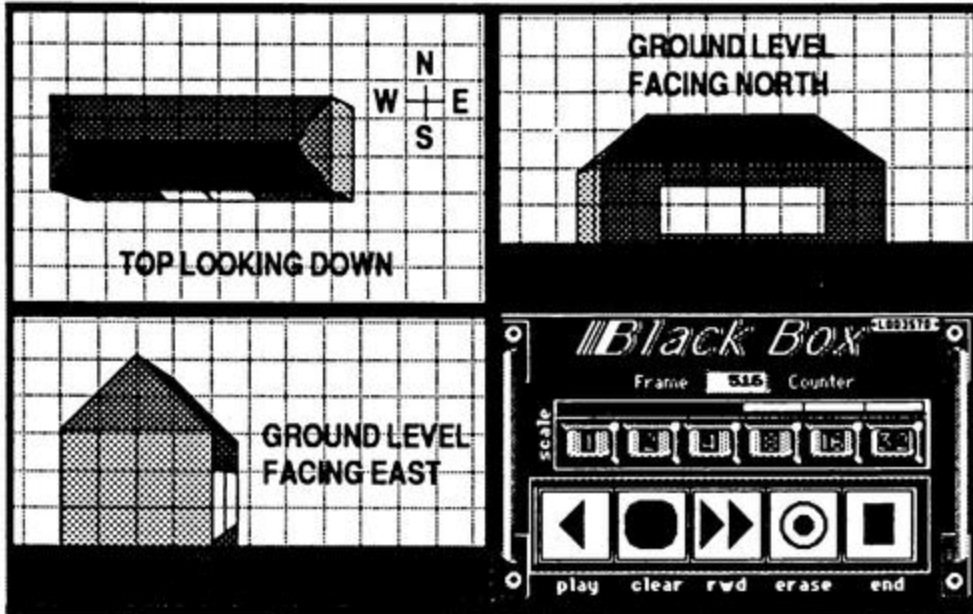

This series of images may make the orientation of the Black Box views a little clearer. They represent how a common object would look from all three of the different views. The usefulness of each view (because of its direction) will depend on what's going on flight-wise at the time, which is precisely why there are three different view directions.

the duration of any flight. It will record up to 10 minutes of flight, with the average being about 4-5 minutes. The total time recorded depends on the complexity of the event. For example, if there are three MiGs in the area, it will record fewer total frames because of having to keep track of the trails of four different planes. *When it reaches the end of its "tape", the history of the flight starts to diminish from the beginning end.* If you fly a long ways and encounter an enemy plane before invoking the Black Box, the "beginning" of your taped path when you invoke the Black Box may be well after takeoff.

Black Box Controls

All controls are accessed by using the mouse pointer and pressing the left hand button.

PLAY

Move the mouse pointer to the **PLAY** symbol and press the Left hand Mouse Button to "advance the tape" and follow the flight sequence. Hold down the Mouse Button and the ribbons of the flight path will be displayed.

CLEAR

Clears the screen of the current trail(s) and recenters the path(s) before showing the next section. If you have a long recording and are viewing the path from a small scale, you will have to clear the views occasionally to see the complete path. *Pressing **clear** does **not** remove the path from memory.* It merely allows you to clear the screen of the previous path portion, so you can better view the remainder to follow.

REWIND

Press **Enter** once while this control is highlighted to go all the way back to the start of the tape.

ERASE

Wipes out any current flight path in the Black Box memory.

END

Takes you back to the same location you were at when you invoked the Black Box.

FRAME COUNTER

Keeps track of frame count over the course of a taped session. The Black Box records "frames" of flight sequence, just like a video recorder. Each digit on the counter really represents two frames, because the Black Box is recording every other frame.

SCALE

Click on the appropriate magnification to choose a scale. Each square on the grid represents an area of 10,000 by 10,000 feet, or approximately 3 to 4 square miles.

Glossary and Abbreviations

A-A - air-to-air

AB - afterburner

ACM - air combat maneuver

ADI - attitude director indicator

Afterburner - acceleration over and above normal military power, achieved by spraying fuel out the back of the engine

A-G - air-to-ground

AGM - American designation for air-to-ground missiles

AIM - American designation for air-to-air missiles

ALQ-131 - ECM (electronic countermeasures) jamming pod designed to confuse ground-based radar systems

AOA - angle of attack

Bandit - plane identified as enemy aircraft

Bank - turn left or right in the air

Bogey - unidentified plane

Buy the farm - go to the big F-16 pasture in the sky

Call Sign - codename for particular fighter pilot

Cat 3 - short for Category 3; certification of plane carrying external weapons in addition to AIM-9J/L missiles

COMED - combined map/electronic display

Coming over the top - aftermath of a vertical climb, leaving plane with no power at the top of the climb. It has to roll over into a dive to pick up airspeed again.

Cones of Vulnerability - circular aiming cues in head-up display

Court-Martial - court decision expelling a member from the Armed Forces

Driver - term for pilot flying (rather than navigating) the plane in a two-seater; also used as a term for pilot in a one-seater, like the F-16.

Duty Roster - crew chief's list of available pilots

ECM - electronic countermeasures

Fighter Jock - slang term for fighter pilot

g - unit of acceleration

GSD - glide slope deviation

HUD - head-up display

ILS - Instrument Landing System

Jamming - act of confusing enemy radar systems with radio frequency noise

JFS - jet fuel system

LD - localizer deviation

Lock-on - acquire a target with radar for the purpose of firing a weapon

Mach - unit of speed measurement equal to the speed of sound

MIA - missing in action

MiG-21 - Mikoyan/Guryevich-21 Soviet-built jet fighter, the most common in the world

ML - military power

Military Power - standard power and acceleration measure

Missing man formation - when a pilot meets an unfortunate and fatal demise, his squadron flies a pattern where one of the planes peels off away from the pattern, symbolizing their compadre's departure forever.

Move in on his six - come in on the rear of another plane

NWS - nose wheel steering

NWSS/LGSI - nose wheel steering system/landing gear status indicator

Pickling - setting a weapon to fire at one specific location, similar to a lock-on.

POW - prisoner of war

Pulling lead - purposely aiming in front of enemy plane to allow for distance to target and target speed in making sure fired weapon scores a hit.

Rookie - pilot without flight experience

RPM - revolutions per minute

Splash one MiG - statement commonly spoken after successfully downing an enemy MiG jet fighter

Spoof - slang term for "fooling" an enemy missile with flares or chaff

SRF - FALCON shorthand for "strafe"

Stick - pilot directional control

The F-16

The F-16A Fighting Falcon is a multirole fighter jet with equally advanced air-to-air combat and air-to-ground strike capabilities. It is a highly maneuverable and relatively lightweight aircraft that was dubbed the "Electric Jet" when General Dynamics introduced it to the world in the mid-1970's. This nickname was applied because of the F-16's high dependence on computers which translate the pilot's actions to the plane in a "fly-by-wire" fashion, rather than conventional hydraulic means.

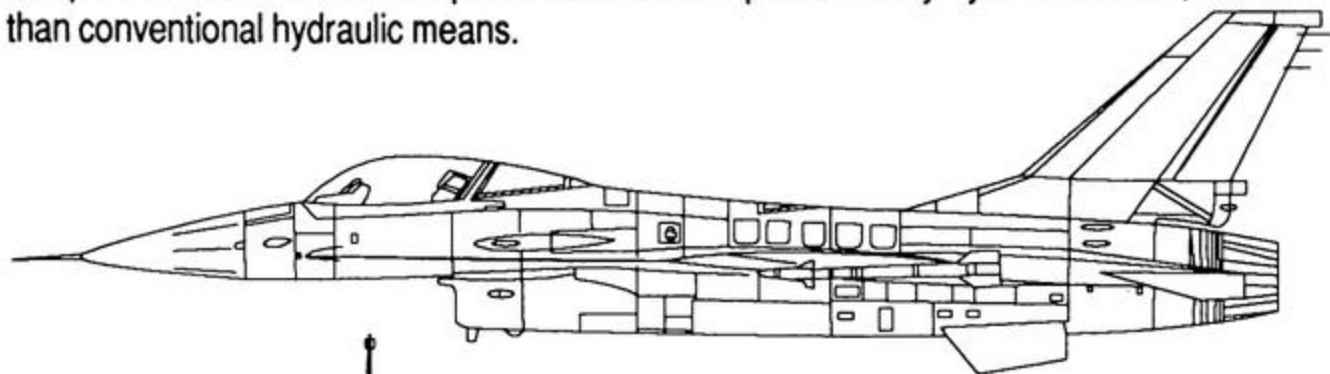

SPECIFICATIONS

Engine: Pratt & Whitney F100-PW-200 turbofan; 23,840 lb static thrust with afterburning

Length: 49 ft 6.75 in (with nose probe)

Wingspan: 31 ft 0 in (without missiles); 32 ft 10 in (with two missiles)

Height: 16 ft 8.5 in

Weights: Empty 14,567 lb; Normal Take-Off (Air-to-Air with fuel and two missiles) 23,300 lb; Maximum Take-Off 35,400 lb

Max Speed: 795 knots/hr (Mach 1.2, or 915 mph) @ Sea Level (with two missiles); 1,172 knots/hr (Mach 2.05, or 1,350 mph) @ 40,000 ft (with two missiles)

Service Ceiling: Over 50,000 ft

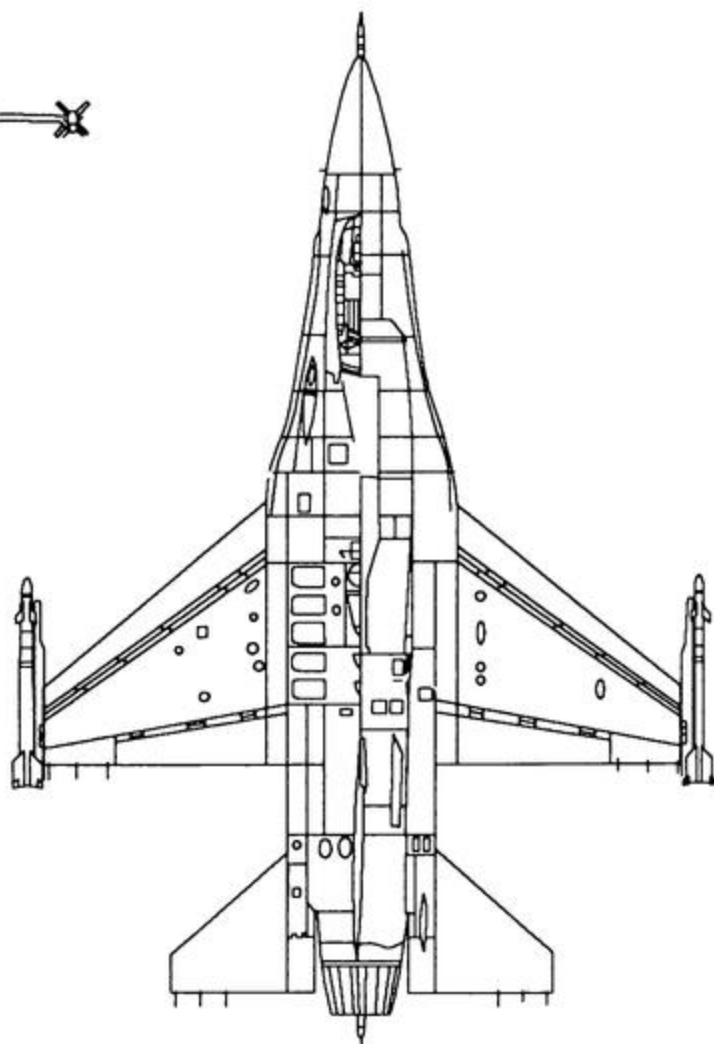

The MiG-21

The Mikoyan/Guryevich (MiG)-21 is the most common fighter jet in the world, and although it originates from the Soviet Union, its influence is felt far outside the Eastern Bloc countries. It carries AA-2-2 radar-guided Atoll missiles, AA-2 Atoll heat-seekers, and a GSh-23 Gun similar to the F-16's M-61A1 Cannon.

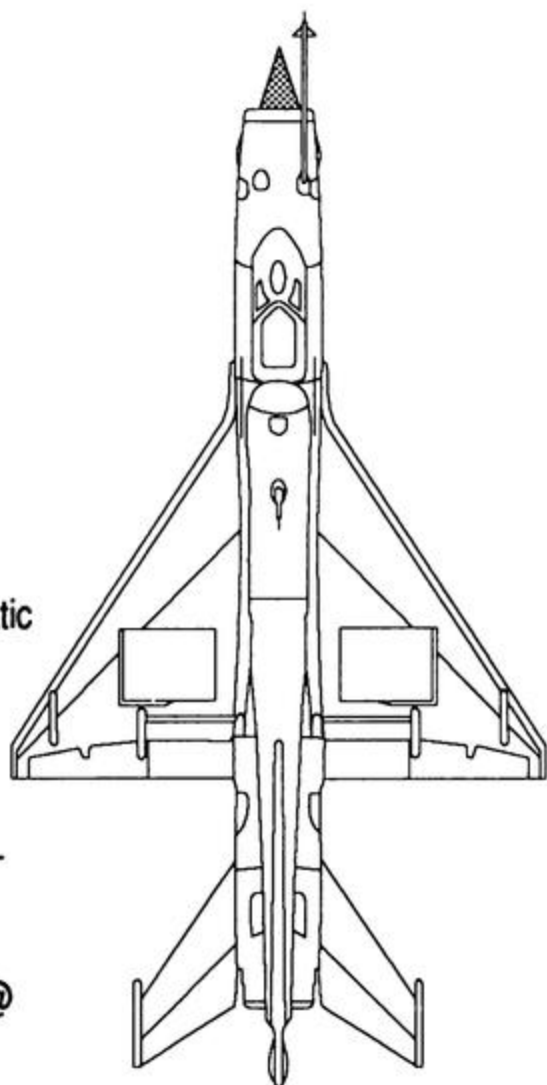
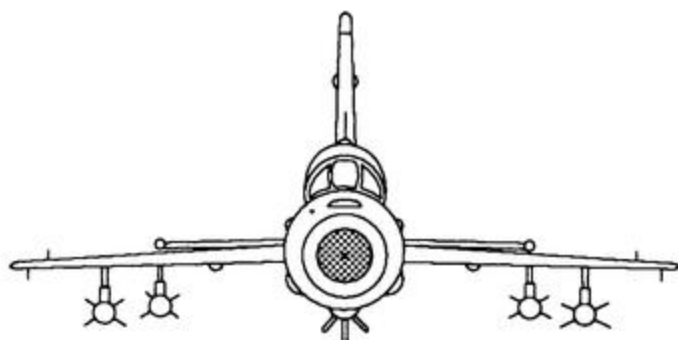
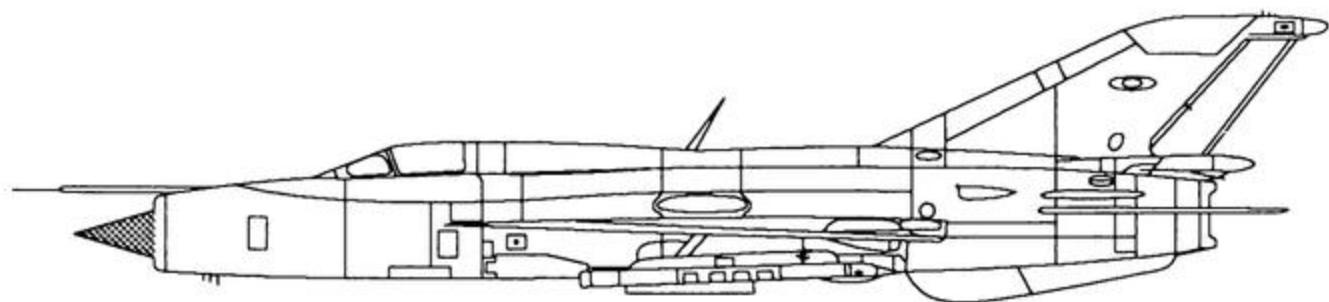

SPECIFICATIONS

Engine: Tumanskii R-25-300 turbojet; 16,720 lb static thrust

Length: 51 ft 4 in (with nose probe)

Wingspan: 23 ft 6 in (without missiles)

Height: 14 ft 9 in

Weights: Empty 13,500 lb; Normal Take-Off (Air-to-Air with fuel and two missiles) 19,300 lb; Maximum Take-Off 22,000 lb

Max Speed: 730 knots/hr (Mach 1.1, or 850 mph) @ Sea Level (no specifications on armament); 1,200 knots/hr (Mach 2.1, or 1400 mph) @ 40,000 ft (no specifications on armament)

Service Ceiling: Over 50,000 ft

Index

- A-4 Skyhawk 44
- A-A (see Air-to-Air)
- Active Duty 9
- Afterburner 25,48,50,86,131
 - Indicator 17,25,86
- A-G (Air-to-Ground) 131
- A-G Target Lock 27,51,69,71
- AGM-65B Maverick Air-to-Ground Missile 19,27-29,46,54,56,68,70,101-105,131
- AIM 131
- AIM 9J Sidewinder Missile 39,54,56,101,102,106
- AIM 9L All Aspect Sidewinder Missile 39,54,56,101,102,106
- Aiming Reticle (Mobile) 66,76
- Aiming Reticle (Fixed) 15,63,64
- Air Brakes 34,48,50,92
 - Lights 13,85,92
- Air Combat Manoeuvres (ACM) 121-129,
 - Break 122
 - Dive Loop 125
 - Engage 122
 - Flip YoYo 124
 - Head On 125
 - High G YoYo 123
 - Immelmann 126
 - Lag Pursuit 124
 - Low G YoYo 133
 - Rollaway 125
 - Scissors 122
 - Split S 124
 - Variable Scissors 123
 - Vertical Loop 125
- Air Force Cross (see Medals)
- Air Target Select key 48,51
- Air-to-Air 16,53,62-65,131
 - Gun HUD 65-67
 - Weapons Select 48-49
- Air-to-Ground 53,68-77
 - Bombing CCIP HUD (mk84 or Durandal) 68-70
 - Missile (See AGM 65B Maverick)
 - Strafe Gun HUD (M61A1)75-77
 - Weapons Select 48,50
- Airfields 55,101-106
- Airspeed 34,80,88,115
 - backup gauge 91
 - Scale 13-15,25,59
- ALQ-131 ECM Pod 11,42-45,55-56,84,102,104,108,109,131
- Altitude 14,31-34,117
- Altitude Scale 13,14,60
- AOA (Angle of Attack) 78-79,131
 - Indexer 13,17,31,78,79
 - Indicator 13,17,31,78,79
- APG-66 (see COMED)
- AR/NWS Light (see Nose Wheel Steering System/Landing Gear Status Indicator)
- Armament 54-56
 - selection 10-11
 - unlimited 10,96
 - weight and drag influence from96
- Aspect Angle 37-39,64
- Attitude Director Indicator (ADI) 18,31
- Autopilot 48,51
 - Light 13,82
- Awards 9,106-111
 - Screen 106-111
- Bandit 101,131
- Bank 21,49,131
- Baudrate 8
- Black Bandit 101,110
- Black Box 48,51,127-128
- Blackout 97-98,113
- Bogey 131
- Bombing 68-70
 - hits 110
- Boresight Radar 37-38

Break-X 39,65
 Break (see Air Combat Manoeuvres)
 Buy the farm 131

Call sign 131

Cantilever bridge 105-106

Captain (see Rank)

Cat 3 load 114,131

Caution lights 92-94

BRAKES 92

BURNER 93

ECM 93

ENGINE 93

FLAP 92

FUEL SYS 93

GUN JAM 92

HUD 93

NAV 94

NWS 92

OXY LOW 94

RADAR 93

STORES 92

WEP ARM 93

Centre /level plane 48,52

Centre Yaw/Pitch 48,52

Clear Air-to-Ground (A-G) Target Lock
 48,51,71,75

Chaff 43-45,48,50,83

Indicator 83

Climb 28,29

Climb angle 15,25,28,34,60

Climb rate 26

Closure rate 38

Cockpit 58

Cockpit Views 18

front 48,49

left 18,25,48,49

rear 48,49

right 48,49,91-94

Collisions 98

Colonel (see Rank)

COMED (Combined Map/Electronics
 Display) 12,17,30,48,49,58,84-
 85,100

Map mode 17,30,48,49,84-85,100

Radar mode 17,37-38,48,49,84-85

Compass 90

Court-martial 9,107,132

Crash (ground) 29,30,34,96-97,107

Directional Indicator (HUD) 62

DISC (disconnect) Light (see Nose Wheel
 Steering System/Landing Gear
 Status Indicator)

Discrettes (HUD) 63-67

Displayed Impact Line 72

Distance to Target 68,71,74

Distance Ranging Scale 65

Distinguished Flying Cross (see Medals)

Dive angle 60

Dive Loop (see Air Combat Manoeuvres)

Double Trouble (see Missions)

Dragons Jaw (see Missions)

Dragons Tail (see Missions)

Driver 132

Durandal anti-runway weapon 55,68,104

Duty Roster 8-9,132

ECM 44,55,84,93,132

EMIT Indicator 84

Eject 48,52,85,93,97,98,106

Ejection Handle 85

End Mission (see File Menu)

Engage (see Air Combat Manoeuvres)

Enemy territory 103

Engine Fire Light 82

External fuel tank 90,120

F-16 (specifications) 134

Fighter jock 132

First Lieutenant (see Rank)

Flaps 34, 48,50,85

Light 59,85

- Flares Indicator 83
- Flip YoYo (see Air Combat Manoeuvres)
- Flight Path Ladder 13-15,34,58,60
- Flight Performance Envelope 115
- Front View (see Cockpit Views)
- Fuel 90,119-120
 - external tank 56,120*
 - Gauge 90,120*
 - internal 56,120*

- G (Gravity) Forces113-118
 - Indicator 13,16*
- Glide Slope Deviation (GSD) Scale 32-33

- Head On (see Air Combat Manoeuvres)
- Head-Up-Display (HUD) 13,58-77
- Heading Scale 13
- High g manoeuvre 113-118
- High G YoYo (see Air Combat Manoeuvres)
- HUD mode indicator 58-77

- Immelmann (see Air Combat Manoeuvres)
- In Range Indicator 58-77
- Instrument Landing System (ILS) 31-35

- Jamming 132
- Jet Fuel System (JFS) Start 24,82
- Jettison
 - all stores 52*
 - centreline stores 52*
- Joystick 3,22

- Keyboard
 - command descriptions 49-53*
 - command layout 21,48*
- Killer Bees (see Missions)

- Lag Pursuit (see Air Combat Manoeuvres)
- Landing 30-35
- Landing Gear 80
- Landscape 26
- LCOS (Lead Computing Optical Sight) 66

- Left View (see Cockpit views)
- Lieutenant Colonel (see Rank)
- Load factor 57
- Localizer Deviation (LD) Scale32-35
- Low G YoYo (see Air Combat Manoeuvres)

- M61A1 Vulcan Internal Gun 54
- Mach 59,132
- Major (see Rank)
- Master Caution Light 81
- Medals 108-111
 - Air Force Cross 109*
 - Distinguished Flying Cross 108*
 - Medal of Honour 109*
 - Purple Heart 108*
 - Ribbons 109*
 - Silver Star 108*
- Menu Select 48,51
- Merits 110-111
- MIA (see Missing in action)
- MiG-21 135
- Military Power 17,25,50,86
- Milk Run (see Missions)
- Missile
 - launching 27-29,62-65*
- Missing in action (MIA) 9
- Missing man formation 107,132
- Missions 101-106
 - Bear's Den 104*
 - Black Bandit 101*
 - Double Dragon 105*
 - Double Trouble 102*
 - Dragon's Jaw 103*
 - Dragon's Tail 103*
 - Grand Slam 106*
 - Hornet's Nest 104*
 - Milk Run 101*
 - Rattlesnake Roundup 102*
 - Stike Palace 105*
 - Venus Flytrap 104*
- Mk 84 2000lb Low Drag Bomb 55
- Move in on his six 13

Normal engine 21, 96
 Nose Wheel Steering (NWS) System
 13,25,80
 Number of Missiles on board 81
 Numeric keypad
 using a21,53

 Oak leaf 109

 Pause key 50
 Pickling 27,69
 Pitch59-60,79
 Prisoner of War (POW) 9,98
 Purple Heart (see Medals)

 Radar (see COMED)
 Radar-guided missile81,84
 Rank 9,11,33,34,96-99
 Rattlesnake Roundup
 RY (ready) Light (see Nose Wheel Steering
 System/Landing Gear Status Indicator)
 Redout 97,98
 Rear View (see Cockpit views)
 Release Cue 72
 Reticle
 fixed 66
 moving 63,76
 Ribbons 109
 Right View (see Cockpit views)
 Rollaway (see Air Combat Manoeuvres)
 Rookie8
 RPM 13,18
 Runway 30, 34

 SA-2 Guideline Missile 43-45
 SA-6 Gainful Missile 43-45
 SA-7 Grail Missile 44
 SAM (Surface-to-Air Missile) 35,42-43,102
 Sensitivity Indicator 13,87
 Sierra Hotel9,111
 Silver Star (see Medals)
 Snapshots 107

Sound 7,51
 Split S (see Air Combat Manoeuvres)
 Spoof 133
 Stall 88
 Stall Light 88
 Stick control49
 joystick 22-23,53
 keyboard 20-21
 Stores Control Panel 13,82
 Strike Palace 105
 Super engine 21,96
 Surface-to-Air Missile (see SAM)

 Target Designator62-63,70,76
 Targeted MiG 37
 Taxiing the aircraft 24
 Threat Indicator 37-38,81
 Threat Warning Light 81
 Threat Warning System 81
 Throttle 25, 49
 Trigger 22, 50
 Trim control 52
 Turn radius 26,114-115

 Variable Scissors (see Air Combat
 Manoeuvres)
 Velocity Vector 61,68,77
 Venus Flytrap 104
 Vertical Loop (see Air Combat Manoeuvres)
 View weapons stores 50

 Waterline 18
 Wheel Brakes 13,25,87

 Yaw 61
 Yaw/Pitch Control 52

Additional Reading

There is an abundance of good books on the market that explain the F-16 and jet fighter technology in greater detail than is possible in this Flight Manual. The following is a representative list of those books.

Basel, G.I. ***Pak Six (A story of the war in the skies of North Vietnam)***. La Mesa, CA: Associated Creative Writers, 1982.

Drendel, Lou. ***F-16 Fighting Falcon in Action (Aircraft No. 53)***. Carrollton, TX: Squadron/Signal Publications, Inc., 1982.

Gunston, Bill. ***F-16 Fighting Falcon (Modern Combat Aircraft 16)***. Shepperton, Surrey, England: Ian Allan Ltd, 1983. Distributed in the USA by Motorbooks International Publishers and Wholesalers Inc. of Osceola, WI.

Gunston, Bill. ***Mikoyan MiG-21***. London, England: Osprey Publishing Limited, 1986. Distributed in the USA by Motorbooks International Publishers and Wholesalers Inc. of Osceola, WI.

Gunston, Bill, and Mike Spick. ***Modern Air Combat***. London, United Kingdom: Salamander Books Ltd., 1983. Published in the USA by Crescent Books, distributed by Crown Publishers, Inc., of New York, NY.

Mason, R.A. ***Air Power: An Overview of Roles***. London, England: Brassey's Defence Publishers Ltd., 1987.

Richardson, Doug. ***An Illustrated Guide to the Techniques and Equipment of Electronic Warfare***. London, United Kingdom: Salamander Books Ltd., 1985. Published in the USA by Arco Publishing, Inc. of New York, NY.

Richardson, Doug. ***F-16 Fighting Falcon (Modern Fighting Aircraft, Volume 2)***. London, United Kingdom: Salamander Books Ltd., 1983. Published in the USA by Arco Publishing, Inc. of New York, NY.

Shaw, Robert L. ***Fighter Combat: Tactics and Maneuvering***. Annapolis, MD: Naval Institute Press, 1985.

Sims, Edward H. ***Fighter Tactics and Strategy, 1914-1970***. Fallbrook, CA: Aero Publishers, 1980.

Walker, J.R. ***Air-to-Ground Operations***. London, England: Brassey's Defence Publishers Ltd., 1987.

The quote on the **FALCON** Flight Manual title page is taken from the above listed title ***Fighter Combat: Tactics and Maneuvering***, by Robert L. Shaw. The remainder are in the public domain or have unknown origins.

HOOK'S GUIDE TO FIGHTER JOCKEY TERMINOLOGY

This list was compiled for us by Lt. Col. B. Hukee, a F-16 pilot. This list is good for use when trying to impress friends and applying for TOP GUN school.

Action	The point of the IP to Target run where the pre-briefed pop-up manoeuvre is begun...Officer's club on Friday.
Admin Formation	A non-tactical formation with the wingman far enough out to be able to do cockpit duties.
Angels	Altitude in thousands of feet..."Viper is at angels 23"(23,000)...U.S. Navy demo team.
Ballistic	Used to describe someone who is mad or who is off doing his own thing, as in,"that jerk, Bob has gone ballistic."—Also used to describe a heater(Sidewinder/AIM-9) or Maverick that doesn't guide. Never used to describe F-16 BCM manoeuvre—See unload and extend.
BFM	Basic Fighter Manoeuvres. What you do to kill the other guy once you are in visual fight.- Implies single ship.
Bingo	Fuel level is such that immediate RTB is required.
Bomb Check	After dropping live bombs, a flight will rejoin to close(finger tip) formation to check for damage...not a good time to pass important info.
Break Turn(Break)	A turn of 6+ Gs used to defeat an enemy missile or fighter gun attack.
Charlie	Cool pilot talk for Yes...little bad guy.."That's a charlie."
Check Turn	A short, crisp hard turn of specified number of degrees..."Viper 2,check 10 right."
Cons	conrails..."The cons are at 35."
Cross Turn	A 180deg turn from speed toward each other... also Deep-6,Hard-6.

Delta Sierra	Dog Excrement... bad ... "The weather is Delta Sierra."
DTOS	Dive Toss... Backup computed bombing mode in F-16 and A-7 ... generally less accurate than CCIP... Only computed mode in older F-4's ... as in, "It's time to get serious about Dive Toss."
Extend	Go faster straight ahead... see Unload..."Viper, extend."
Extended Trail	Trail flown up to 3000 feet back...usually tactical...see Trail.
Fighting Wing	A "tactical" formation where 2 flies in a 60deg cone behind lead from 500 to 1500 feet back... developed during Korean war...see Delta Sierra.
Finger Tip	A non-tactical formation used on initial and in the weather in non-tactical situations
Fox 1	Training radio calls that tells the opponent and friendlies that you have fired a radar missile. N/A for F-16.
Fox 2	Training radio call that tells the opponent and friendlies that you have shot a heat seaker(Sidewinder). If both Limas and Js are loaded, "Fox 2 Lima" is used to differentiate.
Fox 3	Training radio call that tells the opponent and friendlies that you have fired your gun. Not used as much as "Tracking, Tracking, Tracking".
Foxtrot Uniform	Screwed Up..."My radar is Foxtrot Uniform."...see Tango Uniform.
Good Landing	One you walk away from.
Hard Turn	A turn of 4-6 Gs used when a break turn is not required.Used to turn while conserving energy.
I-Place90/180(R/L)	A 90deg or 180 deg turn from speed leaving formation in trail(90deg) or spread(180deg).

InterFlight	A call that says the last radio call you heard was not intended for you..."Viper, say again." "Brewery, disregard.Viper was inter-flight."
Joker	Fuel level is such that plans for egress and RTB are begun.
Locked	A call indicating a radar lock-on or Maverick lock-on.
Manual	(as in 2 is going to manual) To bomb without the system (computer) like we used to do all of the time — see Delta Sierra. —also can refer to a manual radio frequency.
Mover	A moving target on the ground ... "Viper has a mover 2 clicks west moving east." ...clear him on it, he wouldn't have pointed it out if he didn't want to hit it.
No Joy	I don't see it (wingie, lead target, etc.) ...the opposite of no Joy is NOT Joy!
NORDO	No Radio ..."Viper one is NORDO."
Ops Check	A cockpit check of engine, fuel, oxygen, etc.... "Viper ops check, one has 34."
Overshoot	To fly outside the flight path of another aircraft ... see Delta Sierra.
Padlocked	I can't look away or I will lose tally.
Pigeons	Bearing and range... What direction and how far? "Brewery 20 give me pigeons to Nellis. " Not used much anymore.
Pitch (Back) (R/L)	Climbing hard turn ...usually 180degrees..."Viper, pitch right."
Pitch Out	A 180 degree turn to downwind executed over the end of the runway.
Puke	An insult to another pilot. An Eagle driver to a F16 driver could be referred to as a twin engine puke.
Push-it-Up	Add power.

Reverse	Reverse direction of the turn ..."Viper 2, reverse left!"
Roger Roger that	I heard and understood your last transmission ...see Wilco.
Route	A non-tactical formation flown 2-4 ship-widths apart.
Scissors	An air-to-air situation where two aircraft attempt to slow down to get behind the other.
Shackle	A formation manoeuvre where flight members change sides by turning toward each other...used to check 6...sometimes called Weave.
Shooter-Cover	A tactic where the wingman(cover) will stay back to protect leader(shooter).
Sierra Hotel	Shit Hot, good... "The weather is Sierra Hotel."
Slice(Back)(R/L)	Descending hard turn...usually 180 deg..."Viper,slice back left."
Socked In	Weathered in, unable to fly...see Delta Sierra. "The A-10s are socked in at Nellis."
Speed of Heat	Somewhere between the speed of sound and the speed of light. Often used when egressing the target area; the folks back there are no doubt angry and you want to put as much distance between them and your jet as quickly as possible.—Also used to beat the crowd to Happy Hour at O'Club.
Spread	A tactical formation where fighters fly 6000-9000 feet line abreast...defensive in nature...not well suited to very low altitudes (<200')
Tactical Formation	A formation flown in tactical situations, e.g., spread.
Tac Wing	A semi-tactical formation with the wingman 2000 feet+-line abreast.

Tally (ho)	I see it (wingie, lead, target, etc.)...sometimes means bandit only...see Visual
Tango Uniform	Tits Up..."My FM radio is Tango Uniform."...see Foxtrot Uniform.
Trail	A formation where 2 flies < 500 feet behind lead (avoiding dead 6)...may be either tactical or non-tactical...see Extended Trail.
Tumbleweed	I am out of airspeed, altitude, and ideas..No tally, no visual, no clue!...see Delta Sierra.
Unload	Push foward on the stick to reduce drag in order to accelerate.
Visual	I see whatever it is you are describing. Sometimes used to mean I see my Wingie (or lead) as opposed to Tally which then means I see the bandit (see Tally).
Wedge	A tactical formation where the wingman flies on a 45 degree line back from the leader. Offensive in Nature. Good at very low altitudes.
Wilco	I will comply with your instructions. ...see Roger.
Winchester	Out of ordnance

Spectrum HoloByte™ Ninety-Day Limited Warranty

To the original purchaser only, Spectrum HoloByte warrants the magnetic diskette on which this software product is recorded to be free from defects in materials and faulty workmanship under normal use for a period of ninety days from the date of purchase. If during this ninety-day period the diskette should become defective, it may be returned to Spectrum HoloByte for a replacement without charge, provided you have previously sent in your Warranty Registration Card to Spectrum HoloByte or send proof of purchase of the program.

Your sole and exclusive remedy in the event of a defect is expressly limited to replacement of the diskette as provided above. If failure of a diskette has resulted from accident, abuse or neglect, Spectrum HoloByte shall have no responsibility to replace the diskette under the terms of this limited warranty.

If the diskette should fail after the original ninety-day limited warranty period has expired, you may return the diskette to Spectrum HoloByte at the address noted below, accompanied by a check or money order for the applicable replacement fee as outlined on the Warranty Registration Card, a brief statement describing the defect, and your return address. Spectrum HoloByte will replace the diskette provided that you have previously returned your Warranty Registration Card to Spectrum HoloByte, and the diskette retains the original product label.

ANY IMPLIED WARRANTIES RELATING TO THE DISKETTE, INCLUDING ANY IMPLIED WARRANTIES OF MERCHANTABILITY AND FITNESS FOR A PARTICULAR PURPOSE, ARE LIMITED TO A PERIOD OF NINETY DAYS FROM DATE OF PURCHASE. PUBLISHER SHALL NOT BE LIABLE FOR INDIRECT, SPECIAL, OR CONSEQUENTIAL DAMAGES RESULTING FROM THE USE OF THIS PRODUCT. SOME STATES DO NOT ALLOW THE EXCLUSION OR LIMITATION OF INCIDENTAL OR CONSEQUENTIAL DAMAGES, SO THE ABOVE LIMITATIONS MIGHT NOT APPLY TO YOU. THIS WARRANTY GIVES YOU SPECIFIC LEGAL RIGHTS, AND YOU MAY ALSO HAVE OTHER RIGHTS WHICH VARY FROM STATE TO STATE.

Spectrum HoloByte™
division of Sphere, Inc.
2061 Challenger Drive
Alameda, CA 94501
(415) 522-3584

Spectrum HoloByte™ Software License Agreement

THE ENCLOSED SOFTWARE PROGRAM IS LICENSED BY SPECTRUM HOLOBYTE™ TO CUSTOMERS FOR THEIR USE ONLY ON THE TERMS SET FORTH BELOW. OPENING THIS PACKAGE OR USING THE ENCLOSED DISKETTE INDICATES YOUR ACCEPTANCE OF THESE TERMS.

Spectrum HoloByte hereby grants you a non-exclusive license to use the enclosed software and manual subject to the terms and restrictions set forth in this Software License Agreement.

This manual and the software accompanying it are copyrighted, with all rights reserved. You may not copy or otherwise reproduce any part of the software or the manual, except that you may load the software into a computer as an essential step in executing the software on the computer. The original and any back-up copies of the software and the manual are to be used only in connection with a single computer. You may physically transfer the software from one computer to another, provided that the software is used in connection with only one computer at a time. You may not transfer the software electronically from one computer to another over a network. You may not distribute copies of the software or the manual to others. YOU MAY NOT USE, COPY, MODIFY, TRANSFER, SUBLICENSE, RENT, LEASE, CONVEY, TRANSLATE, CONVERT TO ANY PROGRAMMING LANGUAGE OR FORMAT OR DECOMPILE OR DISASSEMBLE THE SOFTWARE OR ANY COPY, MODIFICATION OR MERGED PORTION, IN WHOLE OR IN PART, EXCEPT AS EXPRESSLY PROVIDED FOR IN THIS LICENSE.

Spectrum HoloByte™

division of Sphere, Inc.
2061 Challenger Drive
Alameda, CA 94501

MP1X-FAL3



This was brought to you

from the archives of

<http://retro-commodore.eu>