

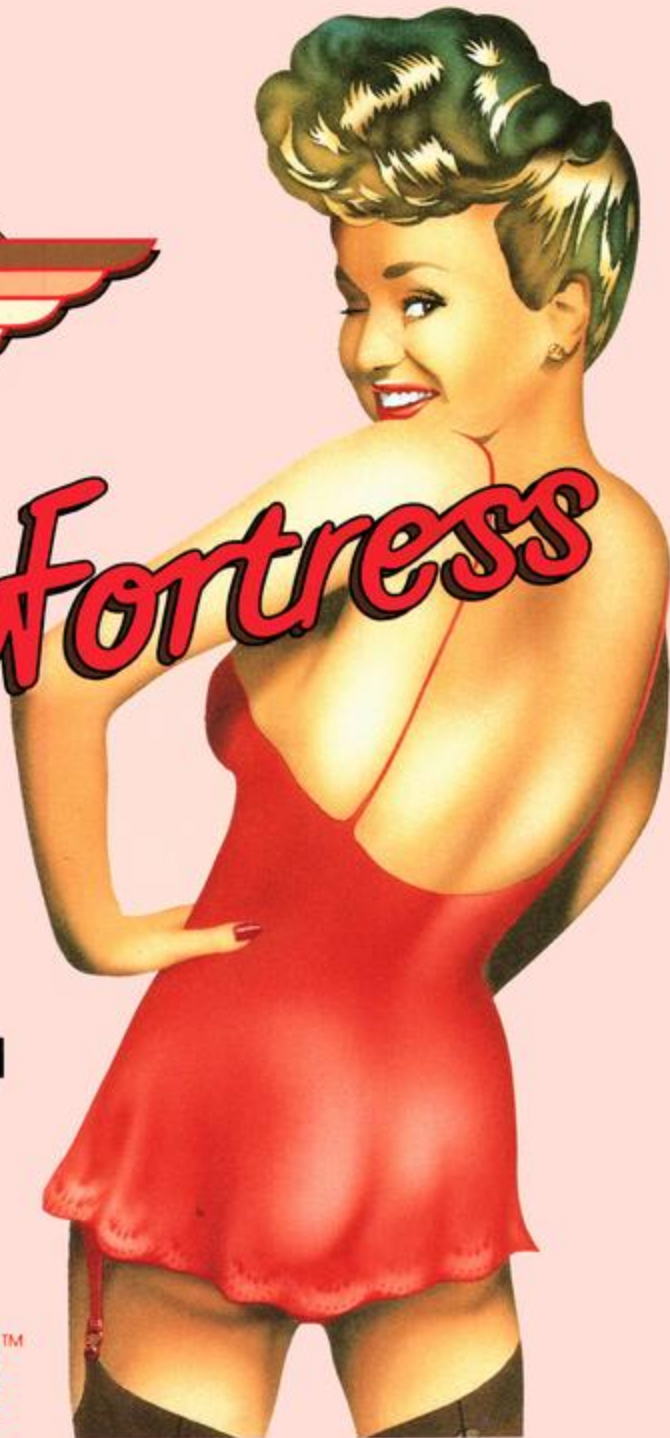

# Flying Fortress

The flying  
experience you'll  
never forget

**MICRO PROSE™**  
SIMULATION • SOFTWARE







# Flying Fortress



Game characteristics described in the documentation may vary on some computers.

Copyright © 1992 MicroProse Ltd.

This documentation and accompanying manual and floppy disks are copyrighted. The owner of this product is entitled to use this product for his or her personal use. Except for back-up copies of the disks for personal use, no one may transfer, copy, back-up, give or sell any part of the manual or the information on the disks, or transmit in any form or by any means, electronic, mechanical, photocopying, recording or otherwise without the prior permission of the publisher. Any person or persons reproducing any part of this program, in any media, for any reason, shall be guilty of copyright violation and shall be subject to civil liability at the discretion of the copyright holder.





# Credits





## CREDITS

*Product Manager*

**Andy Craven**

*Software by*

**Dominic Robinson**

**Ian Martin**

**Graeme Baird**

**Terry Spencer**

*Shapes*

**Derrick Austin**

*Maps*

**Derrick Austin**

**Mark Griffiths**

*Artwork*

**Mark Griffiths**

**Dean Betton**

*Music by*

**Andrew Parton**

**John Broomhall**

*Sound Effects*

**Graeme Baird**

*Game Designer*

**Mike Brunton**

*Project Manager*

**Tim Roberts**



<i>Publisher</i>	<b>Paul Hibbard Pete Moreland</b>
<i>Quality Assurance Testing by</i>	<b>Andrew Lockett Richard Bakewell</b>
<i>Manual Written and Researched by</i>	<b>Alkis Alkiviades</b>
<i>Manual Designer</i>	<b>Joanna Smith</b>
<i>Typesetting by</i>	<b>Sarah Kerr</b>
<i>Picture Research</i>	<b>Alkis Alkiviades Julie Burness</b>
<i>Aircraft Illustrations by</i>	<b>Blue Chip Tel: 0666 824183</b>
<i>Graphics by</i>	<b>Brushwork Tel: 0705 837742</b>
<i>Packaging by</i>	<b>Julie Burness</b>

*All photographs in this manual are Crown Copyright, Imperial War Museum. Courtesy of the Trustees of the Imperial War Museum, London.*



# CONTENTS

## SIMULATION OVERVIEW

<b>Introduction</b> .....	10
<b>Sorting the materials</b> .....	11
Installation/Loading .....	11
This Manual .....	11
<b>Game Overview</b> .....	12
<b>The Crew</b> .....	13
The Airplane Commander .....	14
The Pilot and Co-Pilot .....	14
The Navigator .....	14
The Bombardier .....	14
The Radio Operator .....	14
The Engineer/Top Turret Gunner ....	14
The Gunners .....	15
<b>Layout of the B-17</b> .....	15
Pilot's Compartment .....	16
Nose Section .....	16
Bomb Bay .....	16
Radio Compartment .....	16
Ball Turret and Waist Section .....	16
Tail Gunner's Compartment .....	16

## THE FIRST MISSION

<b>Getting Started</b> .....	20
The Novice Flight Sim Player .....	20
The Experienced Flight Sim Player .....	20
<b>Control Methods Summary</b> .....	20
The Controller .....	20
The Selector .....	20
<b>Starting the Simulation</b> .....	21
<b>The Mission Briefing</b> .....	22
<b>The Configuration Screen</b> .....	23
<b>Inside the B-17</b> .....	23
<b>Pilot's Instrument Panel</b> .....	24-25

<b>Taxiing to the Runway</b> .....	26
<b>The Take Off</b> .....	27
<b>The Crew</b> .....	27
<b>Navigation and Waypoints</b> .....	29
<b>Gunnery</b> .....	29
<b>Bombardier</b> .....	30
<b>Outside Views</b> .....	31
<b>Landing</b> .....	31

## GAME CONTROLS, BOMBER AND CREW OPTIONS

<b>Game Controls</b> .....	36
The Controller .....	36
The Selector .....	36
<b>Copy Protection</b> .....	36
<b>The Bomber Roster Screen</b> .....	36
<b>Save/Load a Campaign</b> .....	36
<b>The Crew Photo</b> .....	37
<b>Mission Briefing</b> .....	38
<b>Training</b> .....	38
<b>Bomber History</b> .....	38
<b>Roster</b> .....	38

## THE MISSION BRIEFING

<b>The Briefing Room</b> .....	42
The Mission .....	42
Mission Details .....	42
<b>Targets</b> .....	43
Primary .....	43
Secondary .....	43
<b>Map</b> .....	44
<b>Recon</b> .....	44
<b>Decline Mission</b> .....	44



<b>Accept Mission</b> .....	44
<b>Configuration Screen</b> .....	44
Difficulty Levels .....	45
Landings .....	45
Bombs.....	45
Mechanical Reliability .....	45
Gun Ammunition .....	46
German Flak & Aircraft.....	46

## **BOMBER OPERATION**

<b>The Six Compartment Screens</b> .....	50
<b>Bomber Gun and Crew Positions</b> .....	50
Pilot's Compartment .....	50
Nose Section.....	50
Bomb Bay.....	51
Radio Compartment.....	51
Ball Turret and Waist Section .....	51
Tail Gunner's Compartment .....	52
<b>Moving Around the</b>	
<b>Flying Fortress</b> .....	52
The Crew .....	53
<b>The B-17 Instrument Panels</b> .....	54
<b>Other Compartment</b>	
<b>Screen Controls</b> .....	54
<b>Views</b> .....	56
Aircraft Selection .....	56
General Aircraft Views .....	56
B-17 Specific Views.....	57
Crew Views .....	58
<b>Other Controls</b> .....	58
Toggle Manual/Computer .....	
Control Crewman.....	58
Configuration Screen .....	58
Accelerate Time .....	58
Skip Time .....	58
Adjust Detail Level .....	59
Film Director Mode .....	59

Pause Game/Resume Game.....	59
Quit to DOS.....	59
Sound Levels .....	59
Hide Game .....	59

## **THE PILOT, CO-PILOT AND FLIGHT CONTROLS**

<b>Flight: A Basic Introduction</b> .....	62
Lift .....	62
The Four Forces .....	63
Speed and Lift .....	63
<b>The Flight Simulator</b> .....	63
<b>The Pilot's Instrument Panel</b> .....	64-65
The Pilot's Control Column.....	64
The Instrument Panel .....	66
<b>The Four Engines</b> .....	67
<b>Other Pilot Controls</b> .....	67
<b>The Take Off</b> .....	68
Starting Engines .....	68
Taxiing and Steering .....	68
Flaps.....	68
Taking Off .....	68
<b>Climbing and Cruising</b> .....	69
<b>Flight Characteristics</b> .....	69
Turns .....	69
Stall and Recovery .....	69
Spins and Dives.....	70
<b>Formation</b> .....	70
<b>Accelerate Time</b> .....	70
<b>Skip Time</b> .....	70
<b>Landings</b> .....	70
Traffic Pattern.....	70
Final Approach.....	71
Landing Roll.....	71
Good/Bad Landing.....	71



## THE BOMBARDIER

<b>Action Views</b> .....	74
The Bombsight View .....	74
Window View.....	74
External View.....	74
Returning to Compartment Screens	74
<b>Bombardier's Controls</b> .....	74
Bomb Bay Doors.....	74
Bombsight Controls .....	75
<b>Identifying the Target</b> .....	75
Primary .....	75
Secondary .....	75
<b>Bombing Procedure</b> .....	76
The Ideal Line .....	76
Overshooting the Target.....	76
Random Targets.....	76
Go Around Again.....	76
<b>The Bombing Formation</b> .....	76
<b>Damage</b> .....	77
<b>Bomb Bay Views</b> .....	77
<b>Tactical Views of Bombs</b> .....	77
<b>On/Off Target</b> .....	77

## THE NAVIGATOR

<b>Views</b> .....	80
<b>The Map</b> .....	80
<b>Setting Course</b> .....	80
<b>Controls</b> .....	80
Estimated Position.....	80
Wounded Navigator .....	81
Fixing your Position.....	81
System Damage.....	81

## THE RADIO OPERATOR AND INTERCOM SYSTEMS

<b>Views</b> .....	84
<b>The Radio Operator Controls</b> .....	84
<b>The Intercom</b> .....	85

## CREW MANAGEMENT SYSTEMS .....

<b>Introduction</b> .....	88
<b>Viewing the Ten Crew Positions</b> .....	88
<b>Jumping into Position</b> .....	88
<b>Crew Skills</b> .....	89
<b>Re-Allocation of Crew Tasks</b> .....	89
Crew Status Indicator.....	90
The Photo .....	90
The 2D Picture .....	90
Moving the Crew Around.....	91
Time to Get There .....	91
Player Control/Computer Control of Crew Member.....	91
<b>Crew Health</b> .....	91
Wounded and First Aid .....	91
Landings .....	92
Oxygen System .....	92
Heating System .....	92
Medals .....	92

## THE GUNNERS: DEFENDING THE B-17

<b>The Clock System of Defence</b> .....	96
<b>Positions</b> .....	96
<b>Views</b> .....	97
<b>The Machine Guns</b> .....	97
Controls .....	97
Jammed Guns .....	98
Sights/Aiming/Deflection .....	98
<b>Dropping Out of Formation</b> .....	98
<b>Escort Fighters</b> .....	98





## **DAMAGE SYSTEMS**

<b>Bomber Damage</b> .....	102
<b>Aircraft Status Screen</b> .....	102
Fires in the B-17.....	102
Engine Fires.....	102
Turret Repairs.....	102
Bomb Bay Doors.....	103
Landing Gear.....	103

### **Crash Landings in**

<b>Occupied Territory</b> .....	103
<b>Crashes in UK Territory</b> .....	103
<b>Bailing Out</b> .....	103
<b>Ditching in the Sea</b> .....	104
<b>Getting Back Home</b> .....	104
POW .....	104
Escape with help from the Resistance.....	104
<b>Replacement Bombers</b> .....	104

## **END OF MISSION**

<b>Debriefing</b> .....	108
Target Damage .....	108
Aborted Mission.....	109
Justified Abort.....	109
Unjustified Abort .....	109
Crew Changes .....	109

## **MEDALS AND PROMOTIONS**

Medals .....	112
Promotions.....	113
Bomber Nose Screen.....	114
Save Game/Bomber/Pilot/Crew .....	114
End Of Tour.....	114

## **A BATTLESHIP FOR THE SKIES**.....118

## **UNITED STATES 8TH AIR FORCE OPERATIONAL PROCEDURE** ..... 124 |

## **A B-17 BOMBING MISSION**

Ground Crew.....	132
Flight Crew.....	134

## **STRATEGIC BOMBING** ....140

## **THE DEVELOPMENT OF THE BOMBER AIRCRAFT**

The Pre-War Decade.....	162
Developments During the War in Europe.....	164

## **THE FIGHTING B-17'S**

The B-17E .....	174
The B-17F .....	174
The B-17G.....	180

## **MISSING IN ACTION** ..... 184 |

## **FLYING IN FORMATION**.....188

## **BOMBS**.....198

## **THE FIGHTER ESCORT** .204

## **GERMAN FIGHTERS** ..... 211 |

## **BOMBER RECOGNITION CHART** 217

## **GLOSSARY** ..... 223 |

## **DESIGNER'S NOTES** ..... 229 |

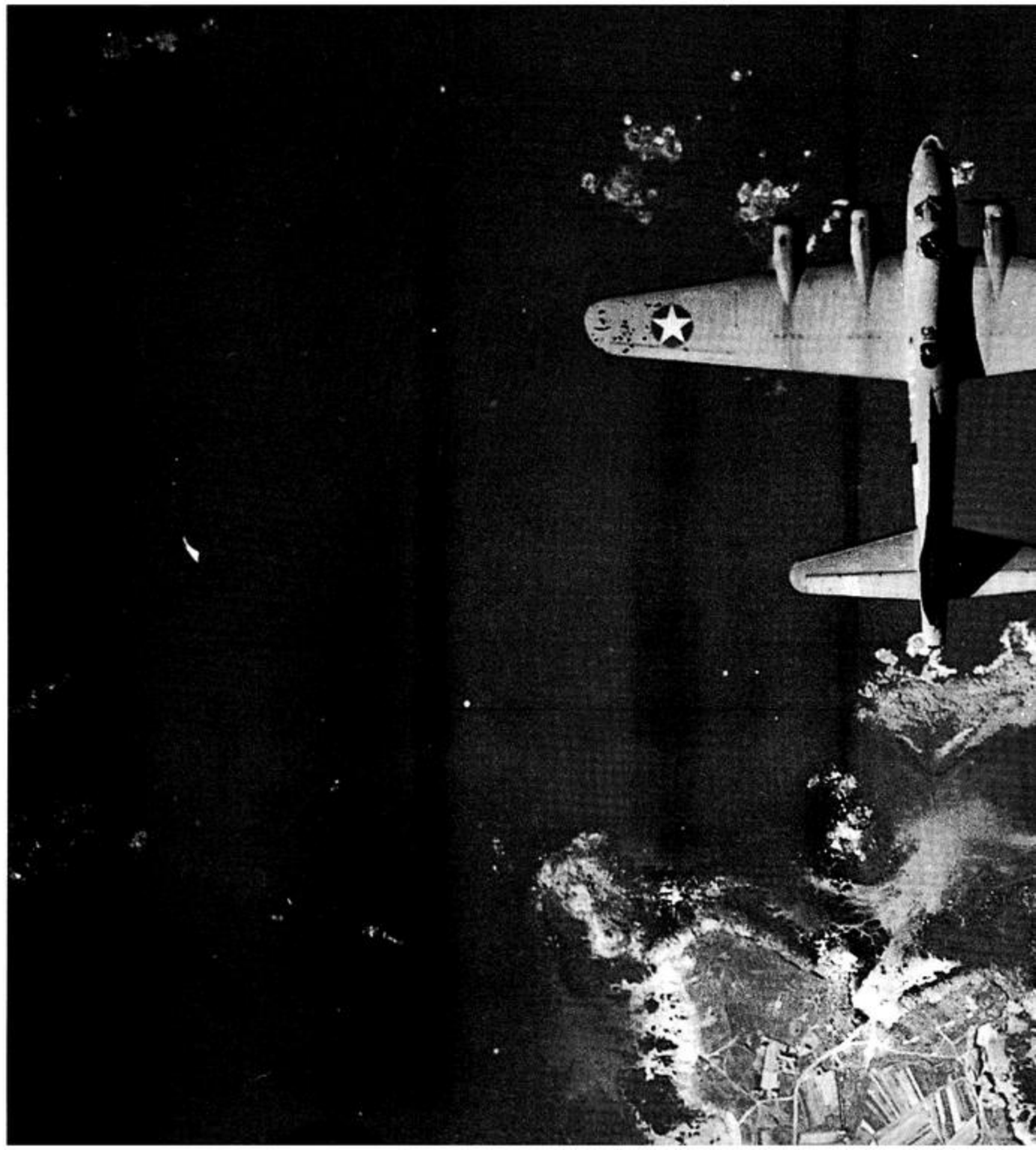

# Simulation Overview

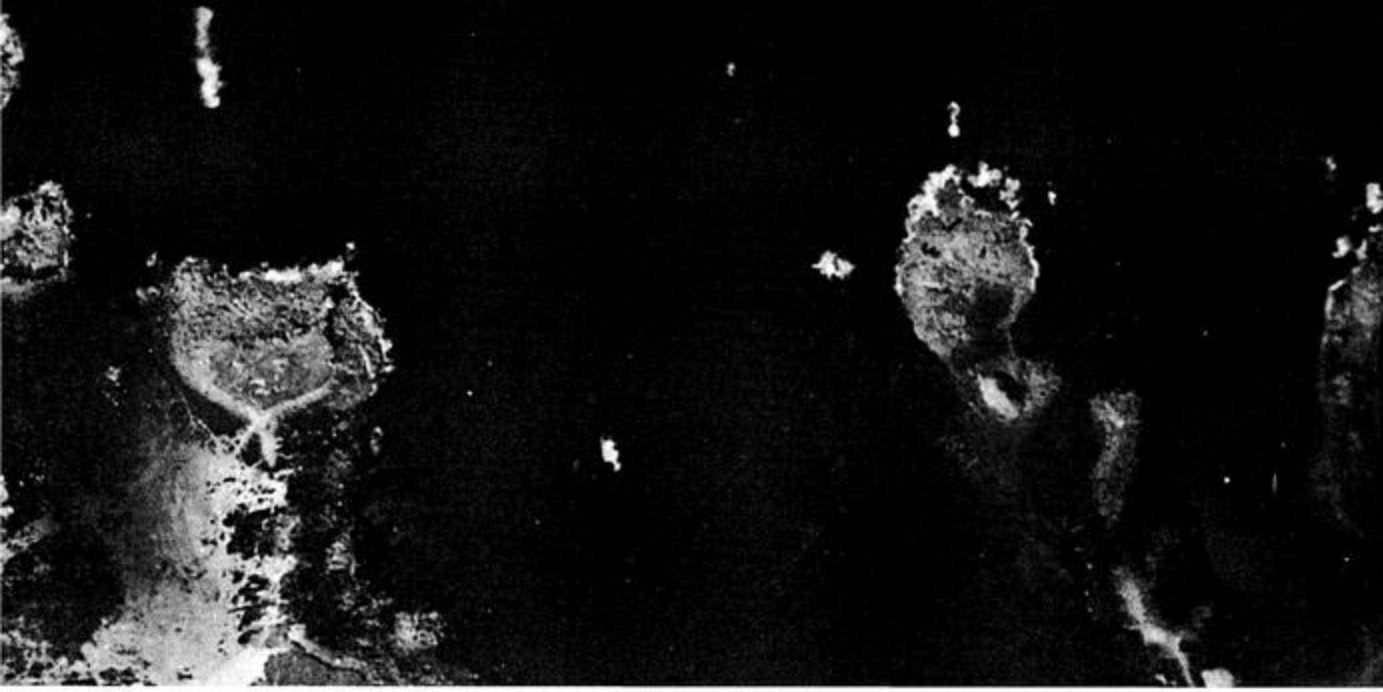
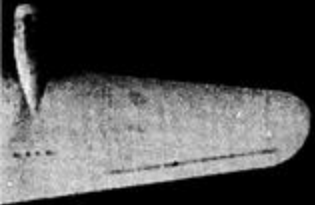



## INTRODUCTION

The B-17 *Flying Fortress* remains a legend in the history of the Second World War. It was the bomber that struck deep into occupied Europe, in daylight, taking on the might of the Luftwaffe, braving the ferocious German flak defences. It was the bomber that could hit precision targets from five miles up then return home, sometimes with massive structural damage. It was the bomber that held ten flyboys, many still teenagers, and bound them into a tough fighting unit.

Now, MicroProse brings you the complete simulation of the *Flying Fortress*. Command the crew over a complete tour of duty, learn how to fly the huge bomber, navigate across Europe, identify targets and operate the famous Norden bombsight. Fight your way there and back dealing with damaged bomber systems and wounded crew. Manage the men under your command, understand their skills and characters, build up their level of efficiency and give them rewards and promotions when they deserve it.

There has never been a simulation like *Flying Fortress*; from customizing a bomber with your choice of nose art and name to the highly detailed mission briefing and breathtaking air combat sequences, we at MicroProse think you'll agree that *it's a flying experience you'll never forget!*



# SORTING THE MATERIALS

Your *Flying Fortress* package contains this Manual, a Technical Supplement, a Key Reference Card, a B-17 Poster and the disks to run the simulation.

## INSTALLATION/LOADING

The Technical Supplement gives specific instructions for loading and/or installing the simulation for your computer. It also provides a **Flight Supplement** and a complete reference for all the keys used in *Flying Fortress*.

## THIS MANUAL

The Manual provides a First Mission Guide, detailed operating instructions for the simulation and a comprehensive history of the B-17 *Flying Fortress* in missions over occupied Europe. The Manual is applicable to all computer systems.



## GAME OVERVIEW

You are the Commander of the *Flying Fortress*. You are responsible for the ten man crew and the B-17G bomber. You can take over from any of the crew and must be prepared to make the correct decisions when things begin to go wrong; assign personnel to treat wounded crew, extinguish fires or manually open jammed bomb bay doors. Manage the men under your command carefully; remember that, although replacement crews are readily available, the less replacement crews you use the more experienced your original crew will become and the better they will be at their jobs. Gunners will shoot down more enemy planes and morale among the crew will be very high.

Your own abilities are of supreme importance. Although you can, if you wish, sit back and let the crew get on with it, you should be able to fly the B-17 and understand all instrument panel controls. To succeed in *Flying Fortress* you must try to be the best Pilot, Bombardier, Navigator and Gunner as well as keeping an eye on all Damage Systems.

You have a lot of bomber to control and your decisions and actions are vital to campaign success.





# THE CREW

## The Airplane Commander

In *Flying Fortress* you are not just a Pilot. You are in charge of a B-17 with all the duties and responsibilities that come with a 10 man Fortress. You are responsible for the airplane and the crew; their safety and efficiency, not just when you are flying into combat, but at all times.

Your crew is made up of specialists: Pilot, Co-Pilot, Navigator, Bombardier, Engineer, Radio Operator and four Gunners. Each must play a part in the combat team whose effectiveness must be reflected in your ability as a Commander.

You must get to know each member of your crew, their character, capabilities and shortcomings. Take an interest in their problems, ambitions and need for extra training. Be aware of their morale; this is always the greatest problem for a Commander of any unit.

Your crew should be trained to work as a team. Get to know each one's duties and any difficulties experienced. To succeed you must have a thorough knowledge of each job and the likely problems that will be encountered.

## The Pilot and Co-Pilot

The Pilot and Co-Pilot must be able to take off and land equally well. They are the senior officers on board. The B-17 is a big plane, more than any one Pilot can handle alone. Make sure the Pilot and Co-Pilot do an equal share of flying, take offs, landings and instrument work. Do not allow one Pilot to increase in skill to the detriment of the other. That Pilot may get injured or be re-assigned to another position and you may have to rely on the skills of the inferior Pilot to get the plane safely back to base.



## **The Navigator**

The Navigator must direct your airplane from take off to the target then back to base. He must know the precise position of the airplane at every moment that it is in the air. Even though his work requires accuracy and concentration he must be able to use the 0.50-cal. machine guns sited at his station, be familiar with all bomber systems and learn how to operate turrets and radio equipment.

## **The Bombardier**

The ultimate aim of the aircraft and crew is effective and accurate bombing. Mission success depends on the Bombardier and what he achieves in a short space of time over the target. When he takes over control of the aircraft on the bombing run he is the Commander and remains so until he signals 'Bombs away!' The Bombardier must understand his bombsight, all his bombing equipment and instruments and must be thoroughly trained in target identification.

## **The Radio Operator**

The Radio Operator must know everything about his radio equipment. He must provide position reports, upkeep the tuning of the radio sets and maintain a comprehensive log of messages. It's advisable that the Radio Operator gain experience of firing the guns and turrets.

## **The Engineer/Top Turret Gunner**

A good combat Engineer knows his airplane, engines and armaments like the back of his hand. He is responsible for all equipment and therefore the lives of all the crew flying in the airplane. He must also be a good gunner.



## The Gunners

The B-17 is designed to be a defensive gun platform. The way your Gunners perform establishes the effectiveness of the *Flying Fortress*. All Gunners must understand the zones covered by their guns and be able to bring them to bear quickly and accurately. Gunners should be experts at aircraft identification, and familiar with the operation of their machine guns. They must be able to use the sights correctly. Good effective Gunners must be able to fire the guns from all other positions on the aircraft.

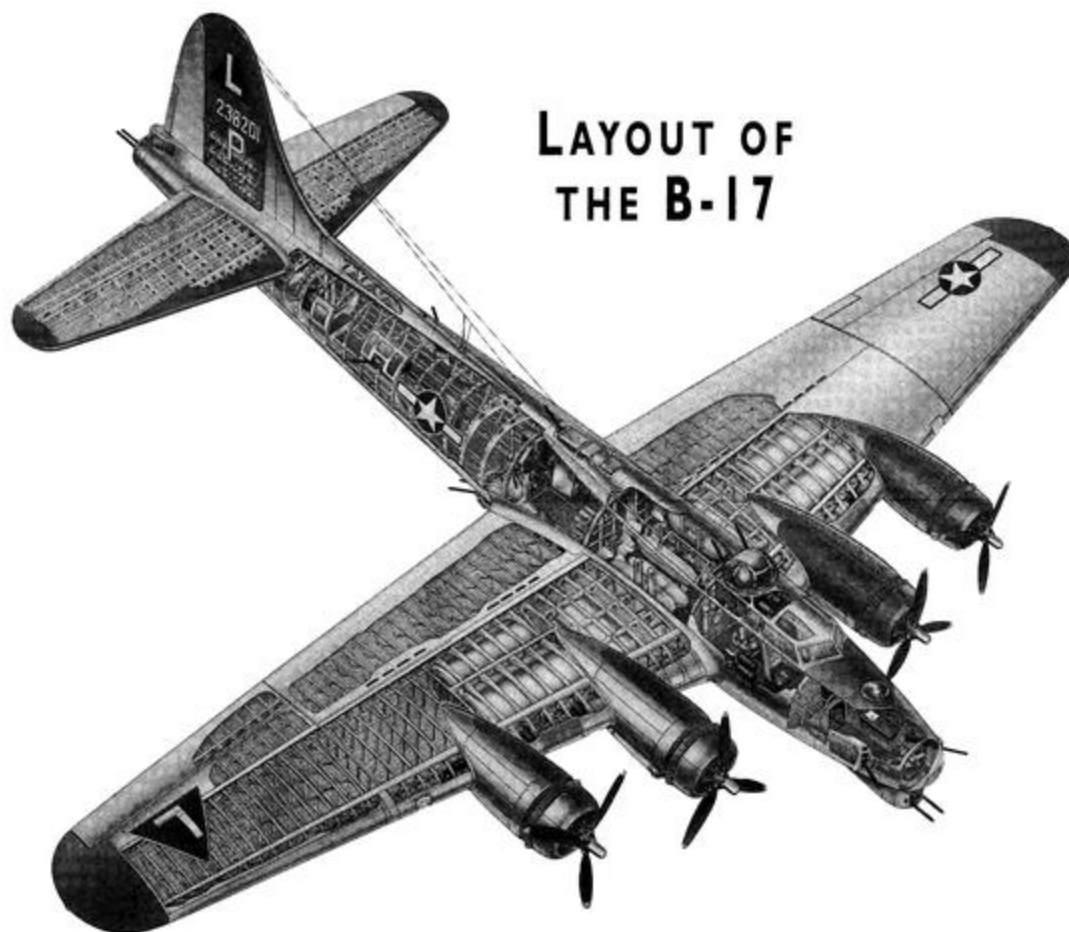

LAYOUT OF  
THE B-17



## **Pilot's Compartment**

The Pilot's Compartment is between the Nose Section and the Bomb Bay. It contains the Pilot and Co-Pilot flight controls and instruments. There is also a power turret with twin 0.50-cal. machine guns for the Engineer to operate.

## **Nose Section**

The Nose Section provides a compartment for the Bombardier and the Navigator and an electrically powered chin turret operating two Browning machine guns located under the Bombardier's station. There are also two cheek guns located in this section.

## **Bomb Bay**

Located just behind the Pilot's Compartment, ten 500lb bombs are stacked here and can be released electrically by the Bombardier or mechanically by any member of the crew.

## **Radio Compartment**

Just behind the Bomb Bay, accessed through a catwalk past the Bomb Bay is the Radio Compartment. All messages are transmitted and received here.

## **Ball Turret and Waist Section**

Behind the Radio Compartment and below the Waist Section is located the Ball Turret equipped with twin 0.50-cal. machine guns. Two flexible 0.50-cal. machine guns are located on either side of the waist section manned by the two waist gunners.

## **Tail Gunner's Compartment**

Situated at the extreme end of the tail, this section has two direct sighted 0.50-cal. machine guns.



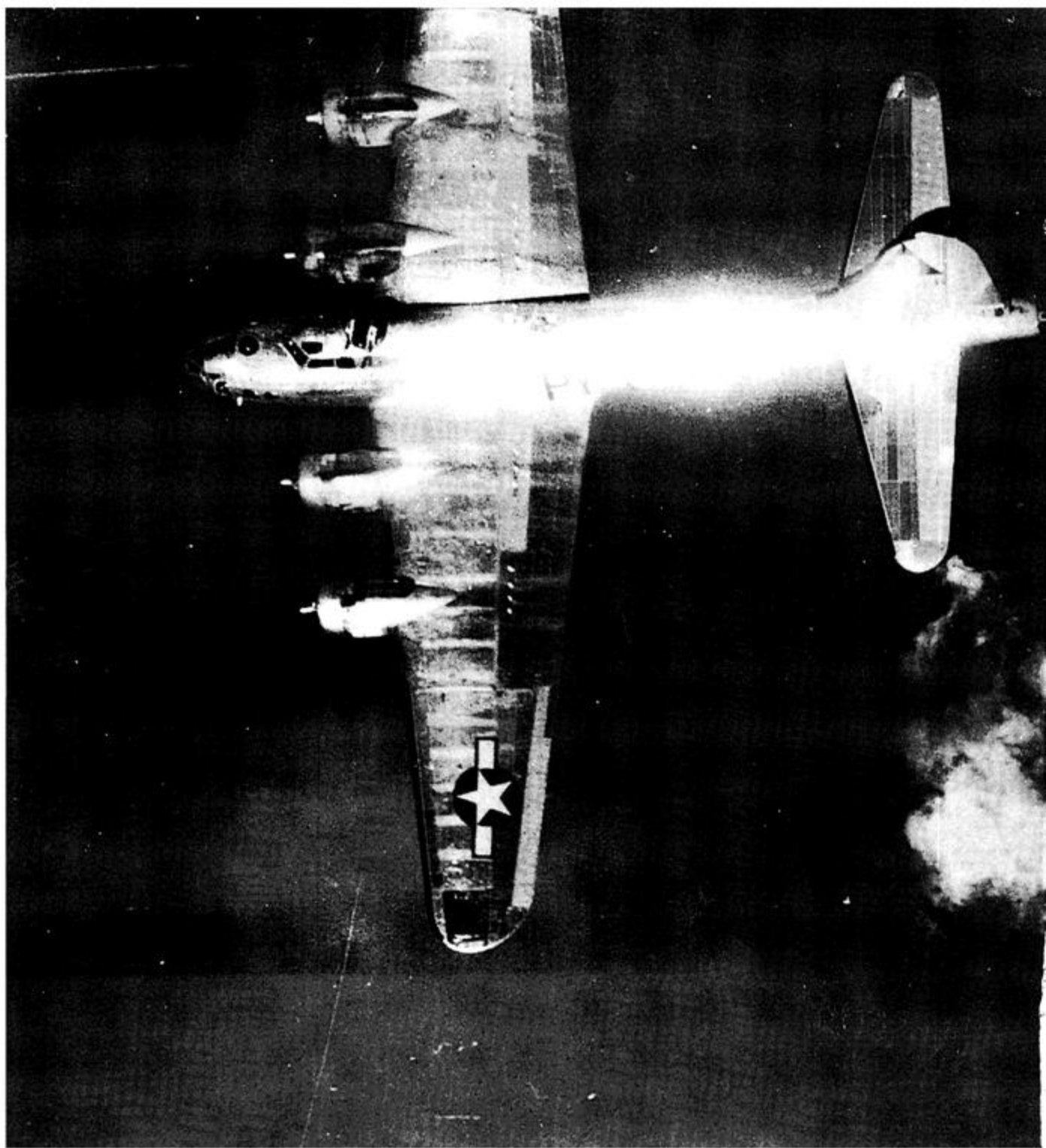



# The First Mission





# THE FIRST MISSION

## GETTING STARTED

### The Novice Flight Sim Player

If this is your first experience of a MicroProse flight sim we suggest you follow this guide but take the **Training** option when it appears in the *Main Bomber Screen*. Follow this section until you come to the **Training** option. Select this option and follow all on-screen prompts. Study the techniques of take offs, flight and landings using the detailed **Flight Supplement** section in the *Flying Fortress Technical Supplement*. You may then return to, and complete, **The First Mission**.

### The Experienced Flight Sim Player

If you are an experienced player of flight simulations you may wish to use this section as a guide to your first mission. You will be given a flavour of Flying, Navigating, Bombing and Combat Procedure. Do not worry about crashing or being shot at; you will be playing the simulation at the lowest level and it will be very forgiving when you make mistakes!

## CONTROL METHODS SUMMARY

Different computer systems have different methods of control so this manual, which is applicable for all computer systems, will refer to the *Controller* and the *Selector*. Get used to these terms and be familiar with your own particular control methods.

### The Controller

The B-17 can be controlled using a Joystick, a Mouse or the Keyboard. In this manual these methods of control will be referred to as the *Controller*. All game and simulation controls will be accessed by one, or a combination of, these three *Controllers*.

### The Selector

The simulation will ask you to select from a list of options, usually an Icon (a small picture) on a green button. In all cases you will be asked to press or click on the *Selector*. This will refer to the Joystick Fire Button, the Mouse Button (Left hand), or certain Keyboard Buttons.



## STARTING THE SIMULATION

This guide will take you through your first mission in the B-17 and is designed to get you into the air as quickly as possible. You will have a chance to choose a bomber, name it and give it your own choice of 'nose art'. Then you will attend a *Mission Briefing*. When you are in the air be prepared to be shot at by flak guns and attacked by enemy fighters.

Firstly, load *Flying Fortress* as specified in the *Technical Supplement*.

### Select Bomber

Once the game has loaded and the title sequences are completed, you will be asked to select a bomber from a choice of six on the *Bomber Roster Screen*.

Press **Reset Bomber**.

You will then be asked to give a Pilot's name.

Enter your name using the keyboard. Press [Return] when you have finished typing.

You will then be asked to choose a piece of 'nose art' and then type in a name for your bomber. Press [Return] when you have finished typing.

Once you have done this, press **Select** and you will see the *Main Bomber Screen* with your choice of 'nose art' and name.

Below the bomber you will see a row of option buttons.

(Novice flight simulation players should now choose the **Training** option using the detailed **Flight Supplement** in the *Flying Fortress Technical Supplement*)

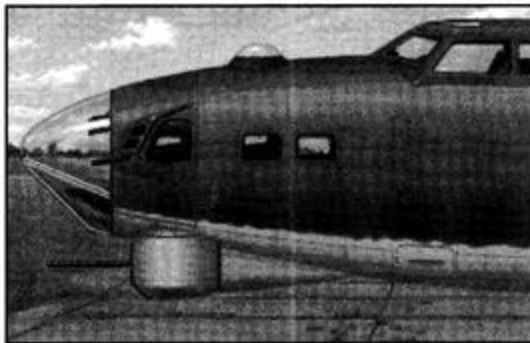

### Select Mission Briefing



## THE MISSION BRIEFING

Along with other crews you will be told about the target for today by the Combat Operations Officer. The first few missions will usually be 'milk runs', over short distances to not particularly well defended targets.

Select **Mission** and you will be given written details of the target. Study the details but do not worry about remembering them, you can always access mission details from the Navigator's position when you are in the bomber.



A pre-dawn briefing for crews of a Flying Fortress Bomber Group on the 6th March 1944. The photograph was taken a split-second after Berlin was announced as the target for that day. It was to be the heaviest daylight raid ever made on the German capital.

Return to *Mission Briefing* and then select **Map** to see the route to the target. Don't worry about the navigation at this stage, your Navigator will be fully briefed about the route.

Return to the *Mission Briefing* screen and select **Recon**. This will show you a short fly-by film of the *Primary* and *Secondary Targets*. Study the target identification chart in the Appendix and make doubly sure what your target looks like.

Return to the *Mission Briefing* room and press **Accept**.

You have completed your first *Mission Briefing*.



## CONFIGURATION SCREEN

(Also accessed later in the simulation by pressing **Alt/C**)

This will allow you to set various options.

Choose **Difficulty Levels**.

If you are new to *Flying Fortress* you are advised to stay in the lowest levels; it is highly unlikely that you have ever flown a simulation like the B-17 and even seasoned flight sim players will find it tricky at first. Remember, the B-17 is not a fast single seater fighter, you will not be performing aerobatics and the successful Commander will be the one who can stay in formation and drop bombs accurately during a level bomb run.

You and your crew will now be transported to your B-17.

## INSIDE THE B-17

You will now be placed in the B-17.

You will start every mission in the Pilot's seat looking out of the Pilot's window in manual control of the *Flying Fortress*.

Remember that, although you are the Commander, you may choose to be one of the Gunners for the entire mission and let the computer controlled crew perform their allotted tasks but for this *First Mission Guide* we suggest you try your hand at everything. If you are going to succeed in *Flying Fortress* you will need to acquire all-round skills. In this section you will perform a take off, bombing, gunnery and a landing.

Press Cockpit View Left **Key** [ (open square bracket key) and Right **Key** ] (close square bracket key) to look around you. You may also access more selective views from within the cockpit by pressing the KeyPad keys **PgUp**, **PgDn**, **Ins** and **Del**.

You will not be able to see the Pilot's Instrument Panel Controls until you press **Key I**. This will show you a full screen of dials and switches.

Press **Key I** to access the Pilot's Instrument Panel. The detailed Instrument Panel gives you all the information about the plane you are flying. Press View Left **Key** [ (open square bracket key) and Right **Key** ] (close square bracket key) to look around the Instrument Panel.



## PILOT'S INSTRUMENT PANEL CONTROLS

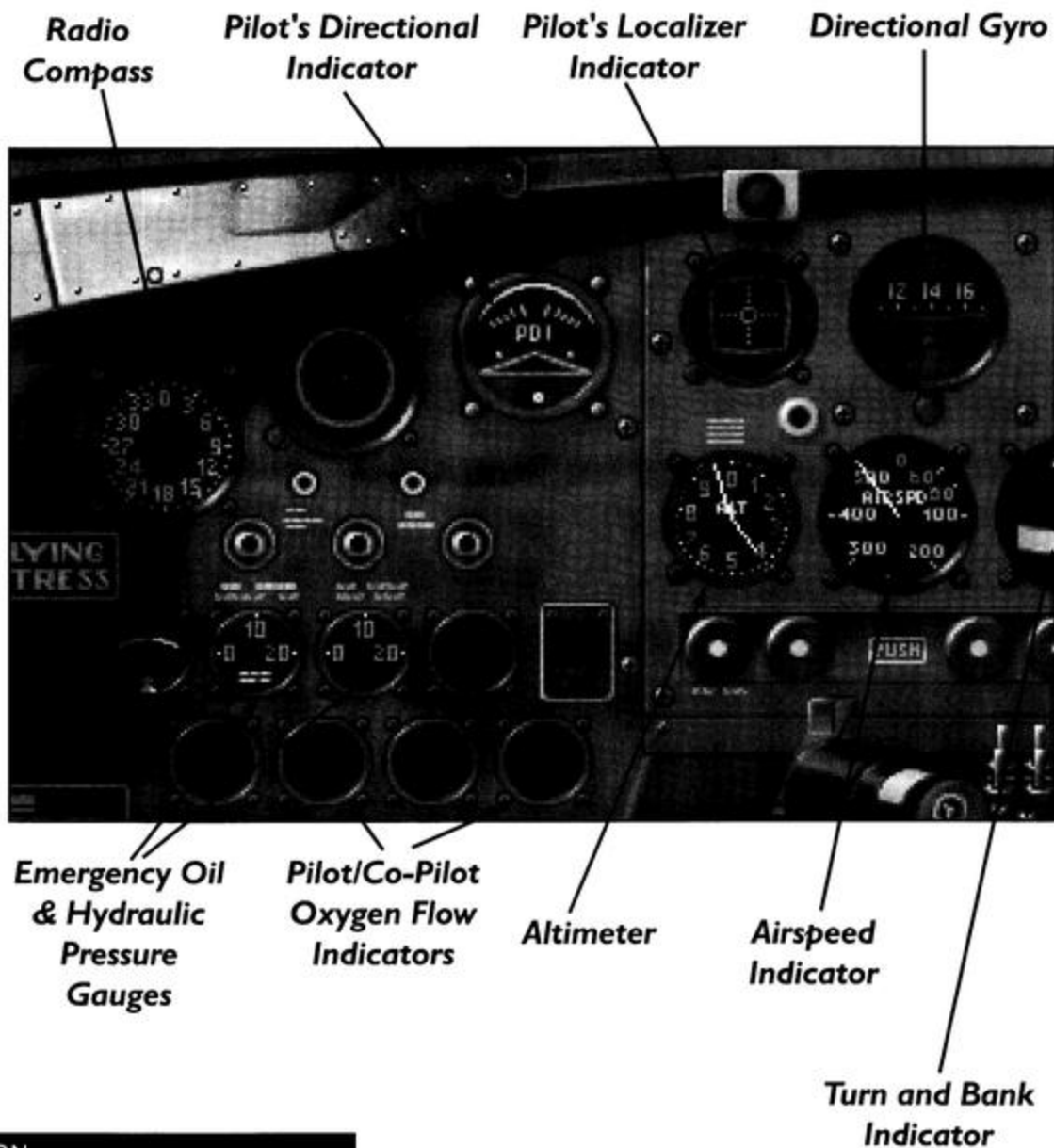



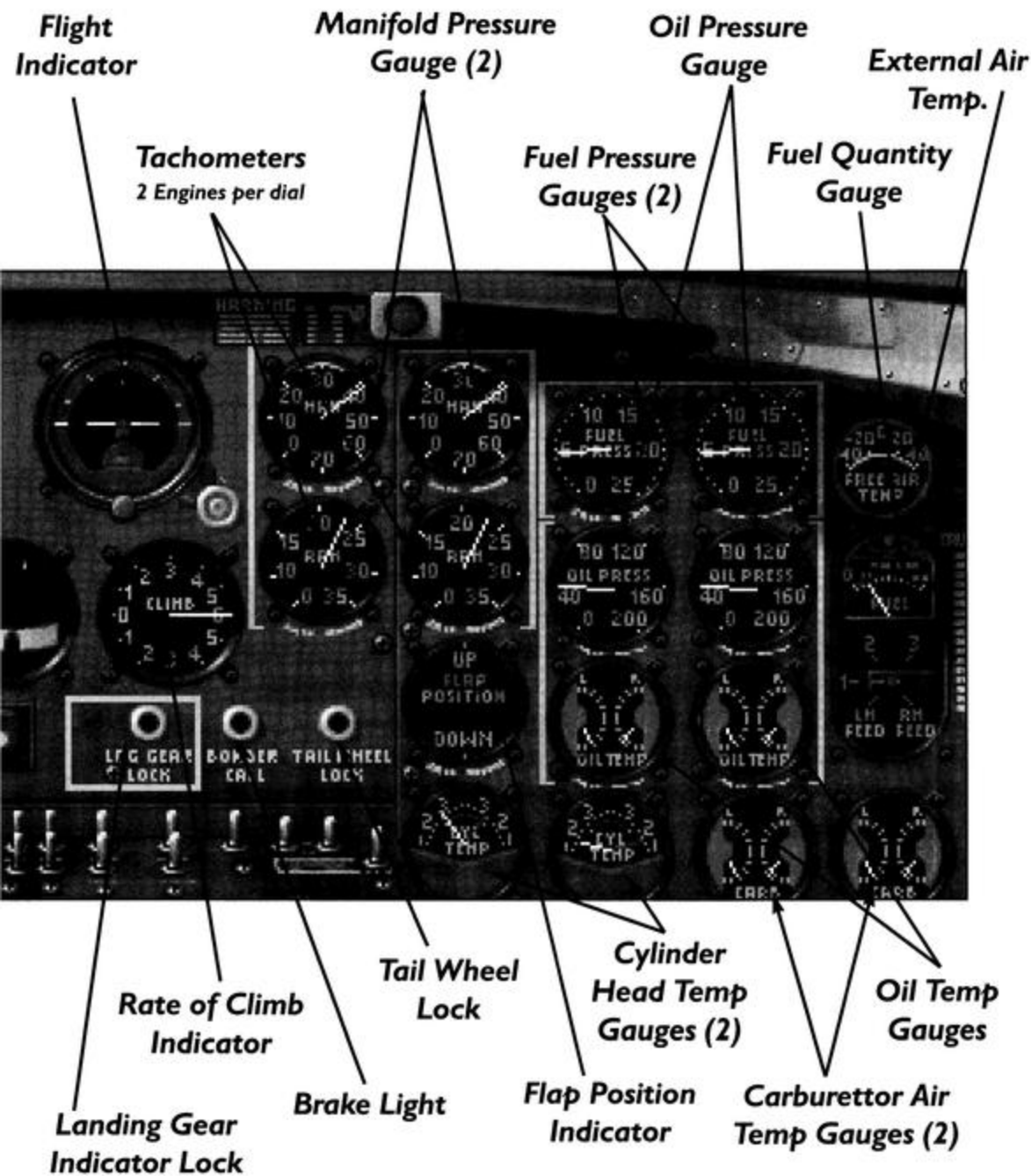



With the aid of this Illustration:

Locate the *Altimeter*

This dial shows height above sea level. The long dial shows hundreds of feet and the shorter dial thousands of feet. Always be aware of your flying height and keep an eye on this dial.

Locate the *Directional Gyro*

This dial will show you your heading. A heading of 0° is North, 90° is East, 180° is South and 270° is West.

Locate the *Airspeed Indicator*

This dial tells you the speed of the aircraft through the air in Miles Per Hour from 0 to 500 mph.

Locate the *Rate of Climb Indicator*

A visual indication of climb/dive angle measured in hundreds of feet per minute. Pointer on 0 means Level Flight.

**Select Key W** to return to Pilot's Window View.

Now you are ready to take off.

Start all four engines in the sequence **[Ctrl]1,2,3,4** (Hold down the [Ctrl] key then press 1,2,3,4)

Make sure Flaps are down. (**Key F**)

Release Brake (**Key B**)

Increase the Throttle to all engines ( **Key [Plus] +** ) until the B-17 begins to move.

In any mission you are the lowest and rearmost aircraft in a V-shaped flying formation. The other B-17's will be assembling in formation around the airfield waiting for you to join them. Once you have got into formation (at the lowest level of difficulty just get close to the other planes) you will set off for the target.

## **TAXIING TO THE RUNWAY**

Steer by moving the Control Column (your *Controller*) left or right.

Steer the bomber carefully to the edge of the take off runway. Try to line up the B-17 along the middle of the runway

You are clear for take off. There is no one else on the runway.



## THE TAKE OFF

When you are on correct line apply maximum power to all four engines ([Shift]/[Plus] +). Do not try to pull the plane into the air. Normally, when you reach an Airspeed of 110-115 mph a gentle pulling back on the Control Column (your *Controller*) will allow the plane to lift itself off the ground. The B-17 controls may feel sluggish compared to other flight simulators, but remember that this is a big, heavy airplane.

After the airplane has left the ground and you are sure that you have sufficient flying speed raise the Landing Gear (**Key G**).

After reaching an airspeed of 130-150 mph, adopt the normal climb attitude (Rate of Climb Indicator at 200-300 feet per minute) and watch the Altimeter rise gently. Look out for your squadron formation.

When you have located your squadron, fly as close to them as you can and join them in formation (complete the V shape). Level off by easing forward on the Control Column *Controller*. Do not try to attempt the mission out of formation, the results may be disastrous.

## THE CREW

When you are cruising in the formation at a level altitude, return to the Pilot's *Compartment Screen* (**Key C**) and check all the crew positions. Do not worry about flying the plane, the computer controlled Pilot will take over.

The first screen you see will be the cut-away *Compartment Screen*. There are six of these in *Flying Fortress* each one corresponding to the manned sections in the bomber. These *Compartment Screens* enable you to control the aircraft general systems, damage, repairs etc. and the ten members of the crew. You may jump into each crew position or move crew members around the airplane. Remember that you cannot jump into any *Compartment* that does not have a crew member in it.

Your first task is to give everyone on board their correct job.

You will always begin missions from the Pilot's *Compartment*. Notice that there are three members of the crew pictured in the compartment and three out of the ten photos are clearly visible. These are the crew in this section waiting for you to assign them a position.



## PILOT'S COMPARTMENT SCREEN

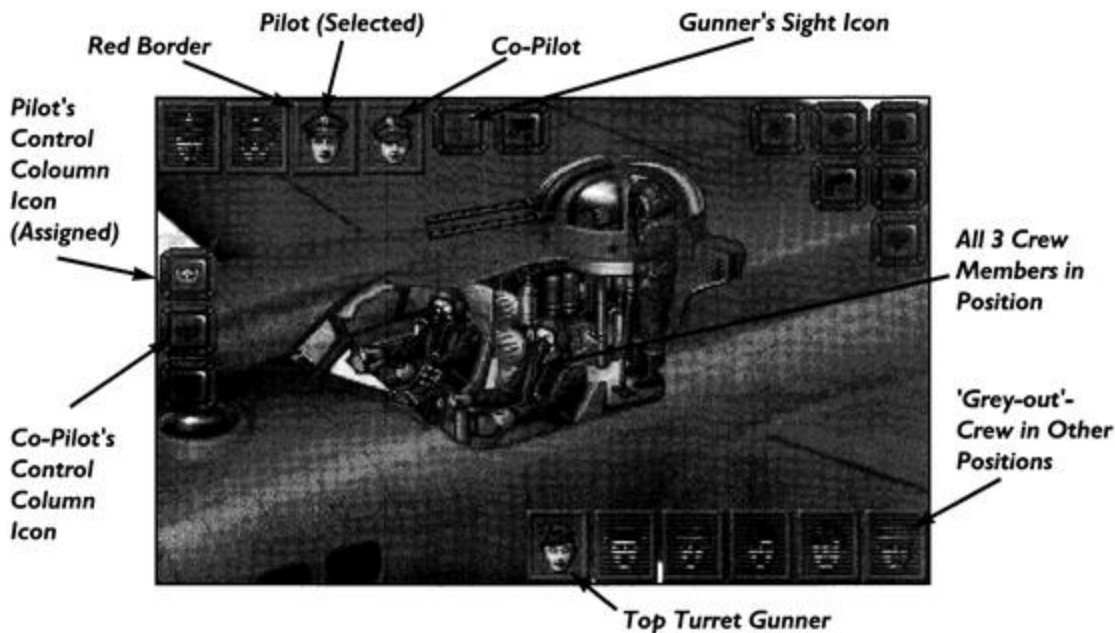

The Pilot is already assigned. The top control column Icon should be highlighted. **Select** the fourth photo from the left on the top left hand side of the *Compartment Screens* (or click on the picture of the Co-Pilot). Note that the selected photo now has a red border around it. This shows the crew member that you are controlling. *You can only control one crew member at any time.*

Now **Select** the second Control Column Icon.



It will light up. You have now assigned the Co-Pilot.

Assign the Top Turret Gunner by selecting the one remaining photo in this *Compartment Screen* that is clearly visible from the lower section and then select the Sight Icon

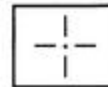

This will also light up. Press **Key C** to see the Gun View. Press **Key M** to assume manual control of the gun position. Make sure the guns are not aimed at any other plane in your formation and test fire them with your *Selector*.

Press **Key C** again to return to the *Compartment Screen*. Control of the gun position will return to the computer crewman.



You have now successfully assigned the three crew members who are positioned in the Pilot's Compartment. Once again, don't worry about flying the airplane, the computer controlled Pilot will have taken over as soon as you left the Pilot's view.

Position your *Controller* over the second crew member from the left at the top of the screen(it will be an unclear 'grey-out' photo) and press the *Selector*. You will move forward to the Nose Section of the airplane.

Select the Navigation Icon.

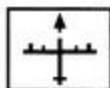

Check that it has lit up and press **Key C**. You will now see the Navigator's table.

## NAVIGATION AND WAYPOINTS

Examine the route of the airplane and the pre-set Waypoints as detailed in the Mission Briefing. Move the *Controller* around to view the rest of the map. Your airplane should be marked on the map, on course for the target. At all times be careful not to press your *Selector* in this mode. You will reset the estimated position of the plane and, if you lose the formation, will almost certainly get lost.

Return to the Nose Section (**Key C**) *Compartment Screen* and click on the photo of the member of the crew at the bottom right. This is the Tail Gunner and you will be transferred to the Tail Gunner's *Compartment Screen*.

Click on the sight symbol

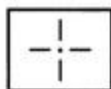

press **Key C** and you will enter the Tail Gun compartment.

Remember that to assume manual control of B-17 positions Pilot, Co-Pilot, Bombardier and all Gunners you must press **Key M**.

Leaving the crew view will always revert the position back to computer control.

## GUNNERY

Gun controls are the same throughout the B-17. Guns are moved in Azimuth (left/right) and Elevation (up/down) by operating the **Cursor Keys** or the *Controller*.

The guns are aimed using the visible sight and fired by pressing the *Selector*, **[Space]** or **[Return]**.



In the event of an enemy fighter attack you will receive messages over the Intercom panel giving you their 'clock' position.

If you do see enemy fighters attacking the B-17 formation try and shoot them down. Holding down the **Shift** button as you move the *Controller* will help you fine tune your gun sights onto the moving targets.

If nothing of interest is happening you may choose to Accelerate Time (**Key Alt/A**) in which case all events will happen much faster. Hold down the keys then release when you wish to return to normal time.

You may choose to Skip Time (**Key Alt/T**) provided the game is in a stable state. If you are in the middle of a combat or bombing sequence you will not be able to access this function. Whole chunks of the mission will be skipped when nothing is happening but the simulation will revert to normal time in the event of something important occurring.

Return to the *Compartment Screen* (**Key C**) and practise moving around the airplane by clicking on the crew photos.

*Note that movement around the plane is by selecting the crew photos not by using the Move Crewman Icons.*

Assign the rest of the crew to positions in the bomber.

Eventually, you will receive an Intercom signal that the bomber is near the target.

## **BOMBARDIER**

Locate the Bombardier (the first photo, top left) in one of the *Compartment Screens* and

click on the Bombsight Icon .



Press **Key C**. You will now be transferred to the nose view of the B-17.

Press **Key I** to access the Bombardier's Instrument Panel. Here you will be able to aim and drop your bombs using the bombsight.

Press **Key M** to assume Manual Control of the Bombardier.

Turn on the bombsight using **Key O**. This key moves control of the plane from the Pilot to the Bombardier. You will now be able to 'fly' the plane using the bombsight controls.

Open the Bomb Bay doors, by pressing **Key D**.

Use your *Controller* (Joystick, Cursor Keys) to adjust the bombsight tracking motor speeds left/right and up/down.



Identify the *Primary Target*. Be sure that you have identified the target correctly and take care to line up the B-17 in the correct bomb run. You will need to keep the target in the bombsight cross hairs for a minimum of 20 seconds of level flight.

Line up the target with the bombsight by using your *Controller*. As Bombardier, you are now flying the plane. Make sure you are tracking the correct target. The Bomb Release Cue Light will come on even if you track any normal buildings. It is there to tell you the bombs will hit the target you are tracking if you release at that point. It is not there to tell you which is the correct target.

When you get the Bomb Release Cue Light drop the bombs with your *Selector*.

The rest of the squadron will bomb with you as long as you remain in formation.

When the bombs have been released. Close the Bomb Bay doors (**Key D**) and return to the *Compartment Screen* (**Key C**). Select the Pilot (third from the left) and fly the B-17 home with the formation.

If you have assigned all crew members to their positions you can observe from their point of view by pressing Function keys **F1** to **F10**. You can take over control of these positions (except Navigator or Radio Operator) by pressing **Key M**.

Tactical View (**Shift/F7**) and Reverse Tactical View (**Shift/F8**) will give you an indication of any nearby activity. For example, if you have released the bombs, you will see them dropping on target; if you are near your base you will see the control tower.

## OUTSIDE VIEWS

Check through the available outside views to see if any of the other bombers in your formation have been damaged by flak or enemy fighters. Experiment with other views detailed in the Key Reference Guide.

## LANDING

When you are near the English base, you will receive a signal over the Message System giving you a heading to land on. If you are in control of the Pilot and do not wish to tackle landing, simply let the computer Pilot control the plane by pressing **Key M**. Sit back and relax. The plane will be landed by the computer controlled Pilot. Watch the approach and landing run. It may help locate the Base in the future when you are playing on a more difficult level.

If you wish to land the plane, remember that you are on the lowest level of difficulty and can attempt a landing without damage to the bomber or the crew.





Approach the airfield in a rectangular pattern at about 800-1000 feet with an airspeed of 130-150 mph. Keep engine rpm's to 2000.

Drop Landing Gear (**Key G**).

Line up the airplane carefully.

Flaps down (**Key F**).

Reduce power on approach (**Key [Minus] -**) and continue to reduce power *gradually* down to 100-120 mph airspeed.

Aim to make a 3 point landing (all three sets of wheels touching down at the same time). Do not tip the nose down. Try to land at about 110-120 mph.

At the lowest level of difficulty your aim is to get the plane on the ground.

After landing throttle back on all engines (**Shift/[Minus Key]-**), allow the plane to roll the entire length of the runway.

Your first flight in a *Flying Fortress* is over.

You will now be Debriefed; told about the accuracy of your bombs and, perhaps, issued with decorations and promotions for you and your crew.

If you have followed this guide then you will have covered the basic elements of the *Flying Fortress* simulation. But remember, the game is not just about bombing accurately on target, it's equally about the management of your crew and how you re-assign them when damage or injuries occur. See the section on *Crew Management* for more details .

If you have felt that this section was too difficult to understand, you are advised to return to the Training Base. Choose the **Training** option in the *Main Bomber Screen* and consult the **Flight Supplement** in the *Flying Fortress Technical Supplement*.

Good Luck!









**Game Controls, Bomber  
and Crew Options**



# GAME CONTROLS, BOMBER AND CREW OPTIONS

## GAME CONTROLS

### The Controller

The simulation can be controlled using a Joystick, a Mouse or the Keyboard. In this manual these control devices will be referred to as the *Controller*. All game and simulation controls will be accessed by one, or a combination of, these three *Controllers*.

It is recommended that you fly the B-17 using a Joystick to give you the realistic 'feel' of the plane.

### The Selector

The simulation will ask you to select from a list of options, switches or dials. In all cases, you will be asked to press, or tap, the *Selector*. This will refer to the Joystick Fire Button, the Mouse Button (left-hand) or certain Keyboard Buttons. If you are controlling the simulation using the Keyboard, without the Mouse or the Joystick, then you can simulate mouse control using the Cursor Keys (Left/Right/Up/Down) for movement and Pad Home/Pad End for left/right buttons.

## COPY PROTECTION

When the simulation has loaded you will be asked a question on the screen. Please refer to this Manual and type in the correct answer from the reference given.

## THE BOMBER ROSTER SCREEN

Pick one of the six airplanes in the squadron to be *your* bomber.

If you wish to continue with your existing bomber, then simply highlight it with your *Controller* and press **Select**, you will then see a full screen image of the nose section of your *Flying Fortress*. You can also view details of each particular *Flying Fortress* history including all your previous missions.

## SAVE/LOAD A CAMPAIGN

You will have the option to Load an existing campaign. See the *Flying Fortress Technical Supplement* for details.



If this is your first mission, then select **Reset Bomber**. The simulation will ask for your name, a piece of 'nose art' from an available selection, and a name for your *Flying Fortress*. Type in your selection and press **[Return]**

Once you have completed these selections you will be shown a full screen image of your particular bomber with your choice of 'nose art' and the name you have chosen painted on its side. Below this you will see a menu of options from where you can control all pre-flight functions in *Flying Fortress*.

## THE CREW PHOTO

Select this option to view the crew assigned to your B-17. The original crew assigned to you is the permanent crew. From the Crew Photo you can access the files of individual members and a summary of their Character Skills in:

Gunnery

Bombing

Technical

Medical

Piloting

Crew members will be better at their own speciality position than any other, but study the files carefully and make a note of any particular strengths or weaknesses. This may be a very important factor when it comes to commanding a damaged Fortress and getting it back home. Remember that you can't do everything yourself!

Crewmen who survive missions will increase in skill and become better at their jobs. If one of your crew is wounded, you can pick a replacement from these files when you return from your mission. Replacement crew members will not be as good at the job as original crew members. When your original crew member is fit for duty, he will return to his old position and appear in the *Crew Photo*.

You can always access all Crew Files from within the *Compartment Screen*.

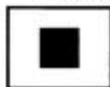

To check on the skills of each crew member click on the appropriate photo then select the Icon.

When you have completed your crew selections return to the *Main Bomber Screen*.



## MISSION BRIEFING

This option will take you into the *Mission Briefing Room* from where all combat missions begin. If you are in the middle of a campaign select this option and turn to the section in this manual on *Mission Briefing*.

## TRAINING

This option allows you and your crew to go to the Training Base and practise aspects of *Flying Fortress* bomber operation. This is your chance to try take offs, landings and flying techniques using the **Flight Supplement** in the *Flying Fortress Technical Supplement*. You can return to *Training* at any time when your plane is at your home base during your 25 missions and it's recommended that you do some training if you have not played the simulation for some time. Select the **Training** option and follow any on-screen prompts.



A waist gunner in a training flight in the USA. There were no bullets in his machine gun but the camera in the centre recorded where the bullets would have hit. Each crew member shot 200 feet of film from four cameras installed in the bomber.

## BOMBER HISTORY

Every one of your 25 missions will be listed in the *Bomber History* file. This is the record of your bomber's performance during your tour of duty. Consult this file to remind yourself of previous missions and targets.

## ROSTER

This option will return you to the *Bomber Roster Screen* showing the six *Flying Fortresses* available to your squadron. In the event of losing a bomber in action, replacement bombers will automatically appear on this screen.











# The Mission Briefing



# THE MISSION BRIEFING

## BRIEFING ROOM

The *Briefing Room* is the place where all combat missions begin. You, your crew and other members of the Bombing Group are shown details of the targets with a map, a fly-by reconnaissance film and given the option to accept or decline the mission. Unless under special circumstances, it's not advisable to decline missions because this will affect crew morale, promotions and medals awarded.

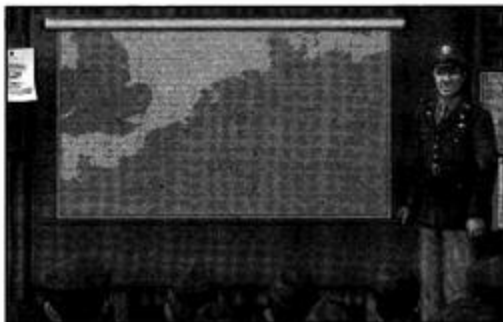

## MISSION

Details of the mission are shown in written form. Study the details carefully, but do not worry too much because you will have a copy of the mission orders with you on the plane, accessed by pressing **Key B** from the Navigator's station.

### Mission Details

#### *Force on Target*

The Bombing Group force from your base.

#### *Date*

The date of the mission.

#### *Take Off*

The time of take off.

#### *Route Out*

Details of Waypoints.



#### *Zero Hour (bombing)*

Estimated time for dropping the bombs.

#### *Bombing Height*

Ideal height from which bombs are to be dropped.

#### *Bomb Load*

The type of bombs you will be carrying.

#### *Turn From Target*

After the bombs have been dropped, which way to turn from the target for home.

#### *Route Home*

The Waypoints to return to your base in England.

#### *ETA English Coast*

Estimated Time of Arrival across English coast.

#### *Friendly Activity*

The amount of fighter escort cover you will have in the mission.

#### *Enemy Activity*

You will be warned of enemy flak and aircraft concentrations around cities, towns and airfields.

#### *Misc. Details*

Any other special circumstances will be made clear to the bombing crews.

## **TARGETS**

### **Primary**

You will be given details of the *Primary Target* for the bombing force. This is your main objective. In the B-17 you cannot save some bombs for other targets, so study the *Primary Target* carefully.

### **Secondary**

The *Secondary Target* will be within easy reach of the *Primary Target*. It is there to give you another option in case of bad weather or temporary mechanical problems. It



will not be as high a priority as *Primary* and you must only resort to *Secondary* when it is clear that your main target is impossible to hit.

## MAP

Use the *Controller* to move around the Mission Map and study the routes carefully. The correct route is marked with two Waypoints, *Primary*, *Secondary Targets*, and the route back to base. It's wise to know where you are at all times during the mission. Remember, if you lose the main formation you will be attacked mercilessly; a lone Fortress is the Luftwaffe's favourite target. Do not rely on navigation by ground features; five miles up you won't see very much and flying low will leave you exposed to anything the enemy flak gunners can fire at you. Although you can 'hedge-hop' your way home, if you so wish, the B-17 is a big target close to the ground.

## RECON

The *Recon* option shows you a fly-by view of the *Primary* and *Secondary Targets* taken by a reconnaissance aircraft. You may view the film as many times as you wish.

## DECLINE MISSION

This option takes you back to the *Main Bomber Screen*.

## ACCEPT MISSION

When you have understood the mission, studied the map and seen the film of the target, you must formally accept the mission orders. Once you have accepted your mission from the *Mission Briefing Room* you will go to the **Configuration Screen**.

## CONFIGURATION SCREEN (ALT/C)

Also accessed at any time during the mission by pressing **Keys Alt/C**.

The player may adjust a number of functions using this option: *Detail Levels*, *Sound* and *Difficulty Levels*.



Note that the *Difficulty Levels* cannot be changed in the middle of a mission. The player must decide on his chosen level and will not be allowed to alter his choice until the end of the mission.

## **Difficulty Levels (Accessed from Configuration Screen Key Alt/C)**

Set the difficulty levels you feel confident of. At first, you are advised to stay in the default level: the lowest level. It is highly unlikely that you have ever flown a simulation like *Flying Fortress* and even seasoned flight sim players will find it tricky at first. Remember that the B-17 is not a fast single-seater fighter, you will not be performing aerobatics and the successful Commander will be the one who can stay in formation and drop bombs accurately during a level bomb run.

You will be given the choice of a number of options:

### **Landings**

#### *No Crashes.*

No matter how fast (airspeed and vertical speed) the aircraft touches down, it lands safely.

#### *Easy Landings*

If there is a crash, no crew will be injured as a result of crash.

#### *Realistic Landings*

The aircraft must land correctly. If there is a crash crew members may be injured.

### **Bombs**

#### *Faultless Bombs*

Bombs will have a wider destructive radius and will always explode.

#### *Historical Bombs*

An accurate simulation of 500lb bomb damage with the possibility of 'duds' in any bomb load.

### **Mechanical Reliability**

#### *A Faultless B-17*

The B-17 will not suffer mechanical failure except by enemy action.



### *Good Reliability*

It is unlikely your B-17 will suffer any mechanical failure.

### *Moderate Reliability.*

The most realistic level.

## **Gun Ammunition**

### *Unlimited Ammunition.*

The supply of ammunition to the guns will not be limited. You do not have to worry about running out of bullets in the middle of air combat.

### *Historical Ammunition.*

You must manage your Gunners and make sure their firing is on target and not indiscriminate.

## **German Flak and Aircraft**

Choose the levels of opposition for enemy flak and enemy aircraft (two values are set separately).

Green

Inexperienced

Average

Veteran

Elite

If you are not an experienced B-17 Commander then it's wise to keep to the lowest level of opposition. Obviously, the rewards are greater if you can cope with the highest level opposition and survive.

After completing your choice of *Configuration*, you and your crew will be driven to your *Flying Fortress* and will be placed in the Pilot's seat looking out of the Pilot's window.







# Bomber Operation





# BOMBER OPERATION

## THE SIX COMPARTMENT SCREENS

The *Compartment Screen* options will appear once you have left the pilot's seat (Key C). These are the basic control screens that allow you to move around the B-17; control all bombing, navigating, radio room, gunnery, piloting, emergency functions and allow you to move your crew to new positions.

## BOMBER GUN AND CREW POSITIONS

If you are not familiar with the *Flying Fortress* bomber positions take time to look around the different compartments and familiarise yourself with the functions of the ten man crew.

The six sections are:

### Pilot's Compartment

The flight deck is between the Nose Section and the Bomb Bay. An elevated enclosure, it contains the Pilot (left seat) and Co-Pilot (right seat) flight controls and instruments. It also has a Sperry power turret with twin 0.50-cal. machine guns for the Engineer/Top Turret Gunner to operate.

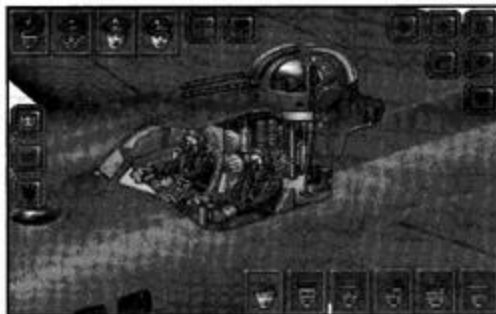

### Nose Section

The Nose Section provides a compartment for the Bombardier and the Navigator and an electrically powered Bendix chin turret located under the Bombardier's station and operated by him. There are also two cheek guns (port and starboard) located in this section.





## Bomb Bay

This is situated just behind the Pilot's Compartment. You cannot access the Bomb Bay until you have assigned a crew man to go there. This may be necessary if you are told that the Bomb Bay doors are jammed or the bombs have to be released manually.



## Radio Compartment

The Radio Operator sits behind the bombs. His compartment is accessed via a catwalk past the Bomb Bay. Like many B-17's of the period the Radio Compartment in *Flying Fortress* does not carry a gun. The Ball Turret Gunner is located in this section during take off.

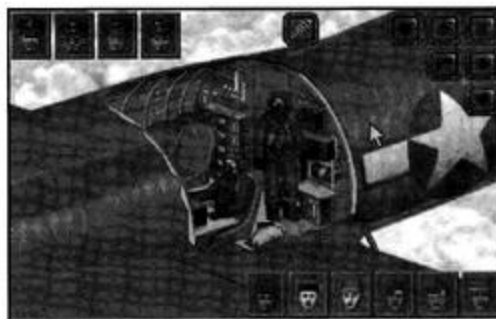

## Ball Turret and Waist Section

Two flexible 0.50-cal. machine guns are located on either side of the waist section operated by the two Waist Gunners. Behind the Radio Compartment and below the waist section is located the Ball Turret equipped with twin 0.50-cal. machine guns to be operated by the Ball Turret Gunner.



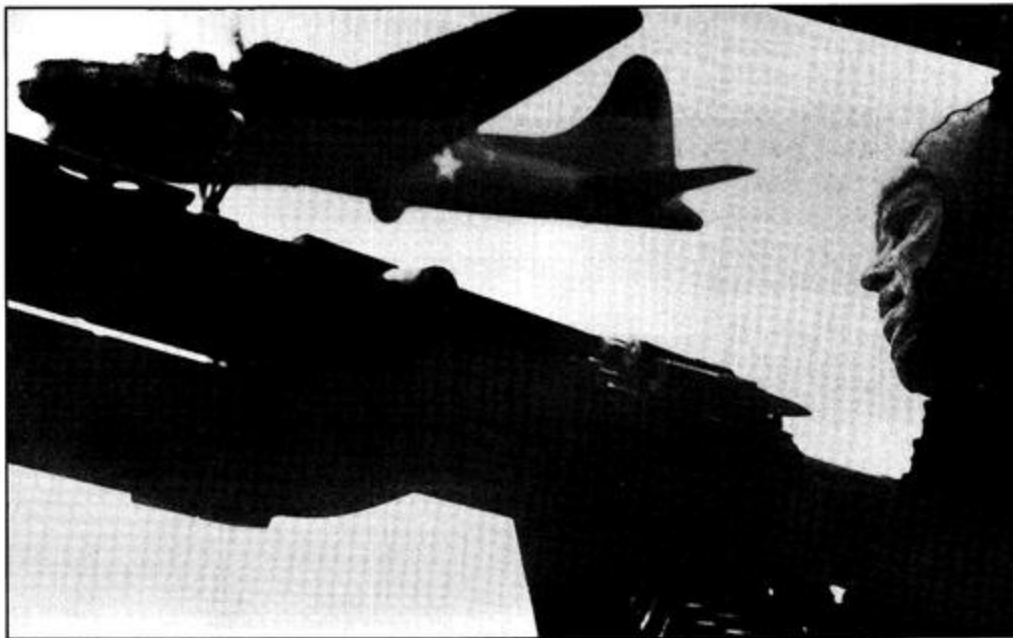

The waist gunner on a B-17F climbing into formation. The aircraft is still below 10,000 feet, the limit above which oxygen masks had to be worn.

## Tail Gunner's Compartment

Situated at the extreme end of the tail, this section has two direct sighted 0.50-cal. machine guns operated by the Tail Gunner.

## MOVING AROUND THE FLYING FORTRESS

Each of the *Compartment Screens* show portrait photos of all ten crew members and complete pictures of those in position. 'Grey-out' portrait photos are crew who are not in that compartment.

Clear photos are crew available in that compartment.

The photo in a red border is the crew member selected for control. *There is always one crew member selected for control at any one time.*



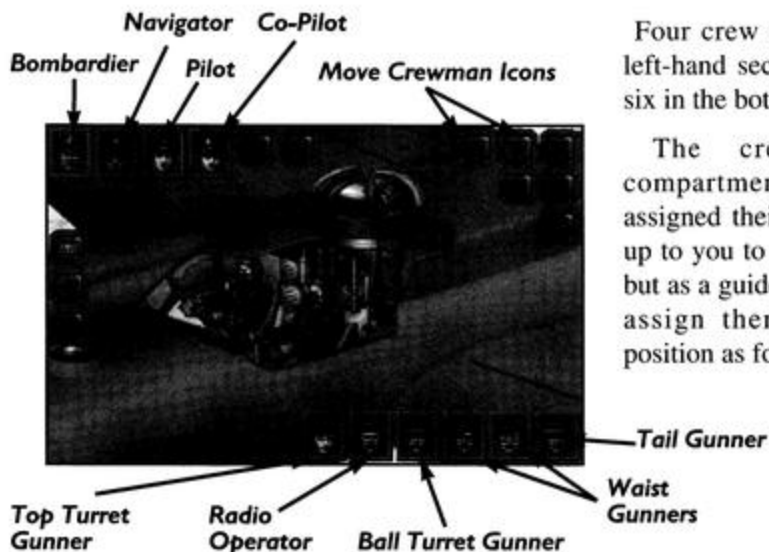

Four crew are situated in the top left-hand section and the remaining six in the bottom right-hand section.

The crew are in their compartments but have not been assigned their correct positions. It's up to you to choose who does what, but as a guideline it is suggested you assign them to their strongest position as follows:

The top four (from left to right)

- Bombardier**
- Navigator**
- Pilot**
- Co-Pilot**

The lower six crew members (left to right):

- The Engineer/Top Turret Gunner**
- The Radio Operator**
- The Ball Turret Gunner**
- The Waist Gunner(left)**
- The Waist Gunner(right)**
- The Tail Gunner**

To select a crew member simply choose a photo with your *Controller* and click on that crew member (either Photo or picture in cut away) with your *Selector*. If you select one of the 'grey-out' photo's you will be taken to their compartment. (*Do not use the Move Crewman Icons*).

The selected photo will then appear with a red border around it. To assign a position click on the appropriate Icon (Pilot's control column, Gunsight etc.) The Icon will light up. If you wish to de-select a position click on the Icon again.

## The Crew

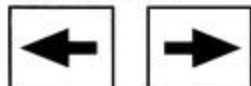

The Move Crewman Icons on the *Compartment Screens* enable you to move individual crew members to other compartments. It is suggested you do not access these functions until you have studied the section on Crew Management. In this section we are simply looking at the crew in the positions you have initially assigned them.



## THE B-17 INSTRUMENT PANELS

The *Flying Fortress* simulation contains four sets of Instrument Panels/Controls that you must become familiar with. Once you have selected the job Icon, **Key C** will always take you into the appropriate position. In the case of the Bombardier, Pilot and Co-Pilot **Key I** will take you to their Instrument Panels.

The Instrument Panels/Controls are:

*Pilot/Co-Pilot* Instrument Panel



*Bombardier* Instrument Panel



*Radio Room* Instrument Panel



*Navigator* Instrument Panel

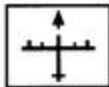

## OTHER COMPARTMENT SCREEN CONTROLS

The *Compartment Screen* also contains other controls that are vital for commanding the *Flying Fortress*.

Remember that in most cases you will have to select a crewman first to perform any particular task.

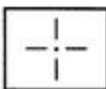



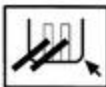



By selecting this symbol and pressing **Key C** you enter the nearest gun position and man the guns. For example, in the Waist Guns/Ball Turret cut-away there are 3 such icons to choose from; one for each manned gun. For more details see *The Gunners: Defending the B-17*.

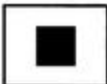

Select this symbol to go to a turret/gun position and repair a turret that may be damaged by enemy action (the exception being the Ball Turret which cannot be repaired by the Gunner and has to be repaired by another crew man from within the fuselage). See section on *Damage*.

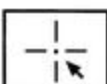

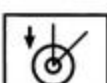
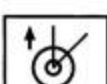
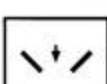
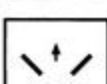
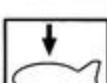
-  Select this symbol if a crew member in this section is injured. See section on *Damage*.
-  The player can order all of the crew to bail out of the *Flying Fortress* by selecting this button.
-  View a crew member's file. Select a current crew member and access this Icon to view his details. **Function Keys F1 to F10** will take you through other crew files.
-  Fight Fire in the appropriate compartment.
-  Go to turret/gun position and unjam guns.
-  Move selected crew member to the next forward compartment.
-  Move selected crew member to the next rearward compartment.
-  Manually lower landing gear.
-  Manually raise landing gear.
-  Manually open bomb bay.
-  Manually close bomb bay.
-  Manually release bombs.





## VIEWS

All views in *Flying Fortress* are determined by the selected aircraft (your B-17, other B-17's, enemy fighters). Select the aircraft first (**Key X** or **Z**) then the required view. The original aircraft chosen is your B-17 but you may wish to select other views of other aircraft. The simulation will remember the last chosen view of all other aircraft and return you to that view if you select it again.

### Aircraft Selection

**Key X** Next Aircraft

**Key Z** Previous Aircraft

### General Aircraft Views

*3D views from current aircraft:*

**Shift/F1** Forward View

**Shift/F2** Rear View

**Shift/F3** Left View

**Shift/F4** Right View

**Shift/F5** Up View

**Shift/F6** Down View

*External views that depend on context. From the aircraft, its targets, bombs, airbase control tower etc.*

**Shift/F7** Tactical View

**Shift/F8** Reverse Tactical View

*External view from notional chase plane*

**Shift/F9** Chase View

*External views from remote camera*

**Shift/F10** External View



### *Moving the remote camera*

<b>Pad PgUp</b>	Pitch Up
<b>Pad PgDn</b>	Pitch Down
<b>Pad Ins</b>	Rotate Left
<b>Pad Del</b>	Rotate Right
<b>Pad Plus +</b>	Zoom In
<b>Pad Minus -</b>	Zoom Out

## **B-17 Specific Views**

This can be used as a shortcut to access all game positions quickly without going through *Compartment Screens*. All positions must be assigned in order to get crew action views otherwise you will see the compartment view.

<b>F1</b>	Bombardier
<b>F2</b>	Navigator
<b>F3</b>	Pilot
<b>F4</b>	Co-Pilot
<b>F5</b>	Engineer/Top Turret Gunner
<b>F6</b>	Radio Operator
<b>F7</b>	Ball Turret Gunner
<b>F8</b>	Left Waist Gunner
<b>F9</b>	Right Waist Gunner
<b>F10</b>	Tail Gunner
<b>Key C</b>	Will take you to last selected crew member if the current view is not a crew view.
<b>Key A</b>	Aircraft Status/Damage View



## Crew Views

These provide views through the eyes of the crew members and various external views while allowing the player to watch or control the actions of the crew members.

- C Compartment View/Action View Toggle
- I Instrument Panel/Equipment View (Bombardier and Pilot/Co-Pilot only)
- W Window View (3D view through aircraft window)
- E External View (3D view from remote camera)

## OTHER CONTROLS

### Toggle Manual/Computer Control Crewman (Key M)

*Flying Fortress* allows you to access each of the 10 crew positions on the plane but you need not take over from the computer control. If you wish to assume control of any position (except Navigator or Radio Operator) press **Key M**. Similarly, if you wish to return to computer control, for example you do not want to handle a difficult landing and want to stay in that position view, press **Key M** again. In all cases when you return to the *Compartment Screens* **Key C**, the position will automatically revert to computer control.

### Configuration Screen (Alt/C)

Available primarily after you have accepted the mission in the *Mission Briefing*, the *Configuration Screen* can also be accessed at any time during the mission. The player may adjust a number of functions using this option: Detail Levels, Sound and Difficulty Levels. Note that the Difficulty Levels cannot be changed in the middle of a mission, the player must decide on his chosen level and will not be allowed to alter his choice until the end of the mission.

### Accelerate Time (Alt/A)

This function will accelerate the speed of the game by a factor of 5. Hold down the keys and release when you wish to return to normal time.

### Skip Time On/Off (Alt/T)

This function will skip chunks of the game but will revert to normal time in the event of something happening that's important to the mission.



## **Adjust Detail Level (Cycle through Alt/D)**

Also accessed from the *Configuration Screen*. You can cycle through a number of detail levels at any time by pressing **Alt/D**. The simulation will play smoother and faster with less detail turned on.

## **Film Director Mode Toggle (Alt/M)**

Choose this function to view all the action around you. There is a lot happening in *Flying Fortress* you may never get to see. Film Director Mode will cut to the most exciting events of the mission.

## **Pause Game/Resume Game (Key P)**

The simulation will freeze immediately until the key is pressed again.

## **Quit to DOS (Ctrl Q)**

If you wish to jump out of the simulation and return to your particular Disk Operating System.

## **Sound Levels (Alt/S)**

Also accessed from the *Configuration Screen*. Adjust the simulation sound to the level of your choice at any time by pressing **Alt/S**.

## **Hide Game (Alt/B)**

Immediately pauses the simulation and clears the screen, concealing what software is really running on the computer. To resume press the keys again.



# The Pilot, Co-pilot and Flight Controls





# THE PILOT, CO-PILOT AND FLIGHT CONTROLS

## FLIGHT: A BASIC INTRODUCTION

A rudimentary portrayal of the physics of flight.

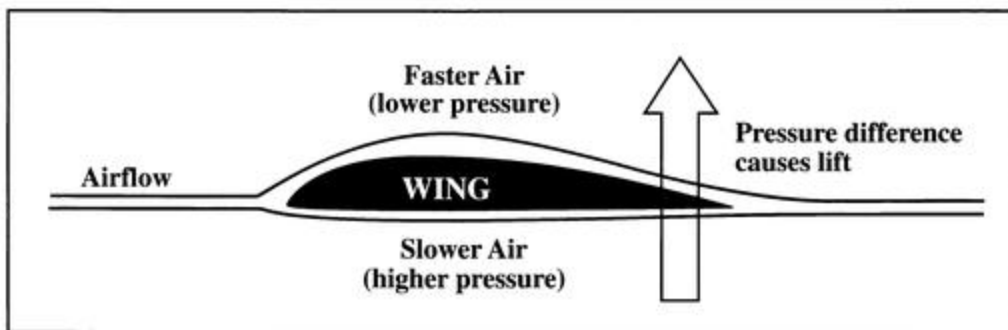

### Lift

Aircraft fly because of air pressure difference as air flows over and under the wing. The wing design and airflow result in air moving faster over the top than over the bottom. This causes high pressure beneath the wing and low pressure above it. The wing is pushed upward, providing lift. If the pressure difference is great enough, the upward lift is greater than the plane's weight (i.e. the force of gravity).

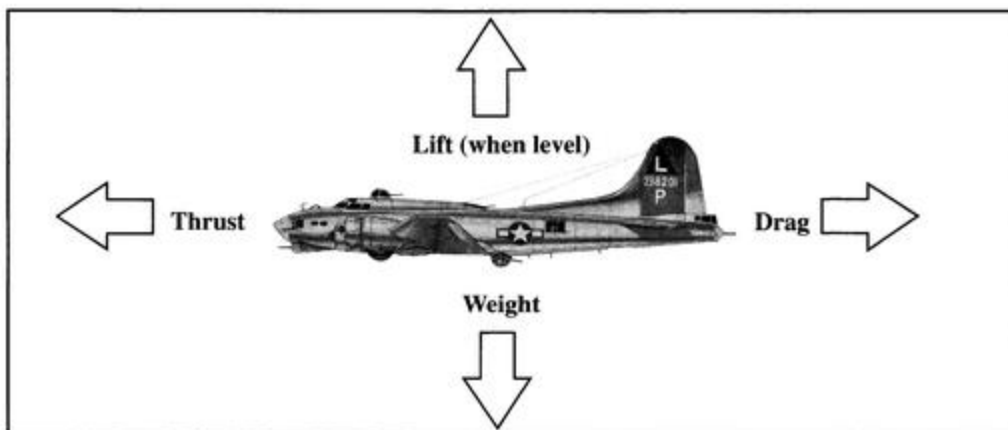





## The Four Forces

Aircraft in flight have four basic forces acting on them. *Thrust* pushes the planes forward depending on engine power. *Drag* reduces the effect of thrust, but is relatively constant. Therefore, when horizontal, more thrust means faster forward velocity. *Gravity* pulls the plane toward the ground, regardless of the plane's attitude. *Lift* pushes upward from the wings, directly opposing gravity when the wings are level.

## Speed and Lift

The amount of lift generated by the wing varies with airspeed. The faster the plane flies, the faster the air flows, so greater the pressure difference. If your plane is in level flight at a certain speed, reducing the speed reduces lift, causing a descent (even though you didn't nose down).

## THE FLIGHT SIMULATOR

To access all flight controls you must choose the Pilot or Co-Pilot photo from the *Compartment Screen*,

then select the Control Column Icon.



**Key C** will place you inside the

Pilot's Compartment and give you a view out of the Cockpit.

By pressing **Key [** (open square brackets) you can move the view left and by pressing **Key ]** (close square brackets) you can move the view right. You may also access more selective views from within the cockpit by pressing the Pad keys **PgUp**, **PgDn**, **Ins** and **Del**.

To view the B-17 Pilot's Instrument Panel press **Key I**.

The B-17 has numerous dials and switches which you should become familiar with. Study the Pilot's Instrument Panel Diagram on pages 64-65 of the manual.

Press **Key [** (open square brackets) to move your view left and **Key ]** (close square brackets) to move your view right.

You can easily raise your view away from the Instrument Panel by selecting **Key W**.

Press **Key I** to return to Instrument Panel View.

**Key M** will always toggle player/computer control. The default (existing mode) will be computer control, except at the beginning of the mission when you will be in position as the Pilot. **Key M** will not affect Navigator or Radio Operator controls.

Press **Key C** to return to *Compartment Screen*.



Radio Compass      Pilot's Directional Indicator      Pilot's Localizer Indicator      Directional Gyro

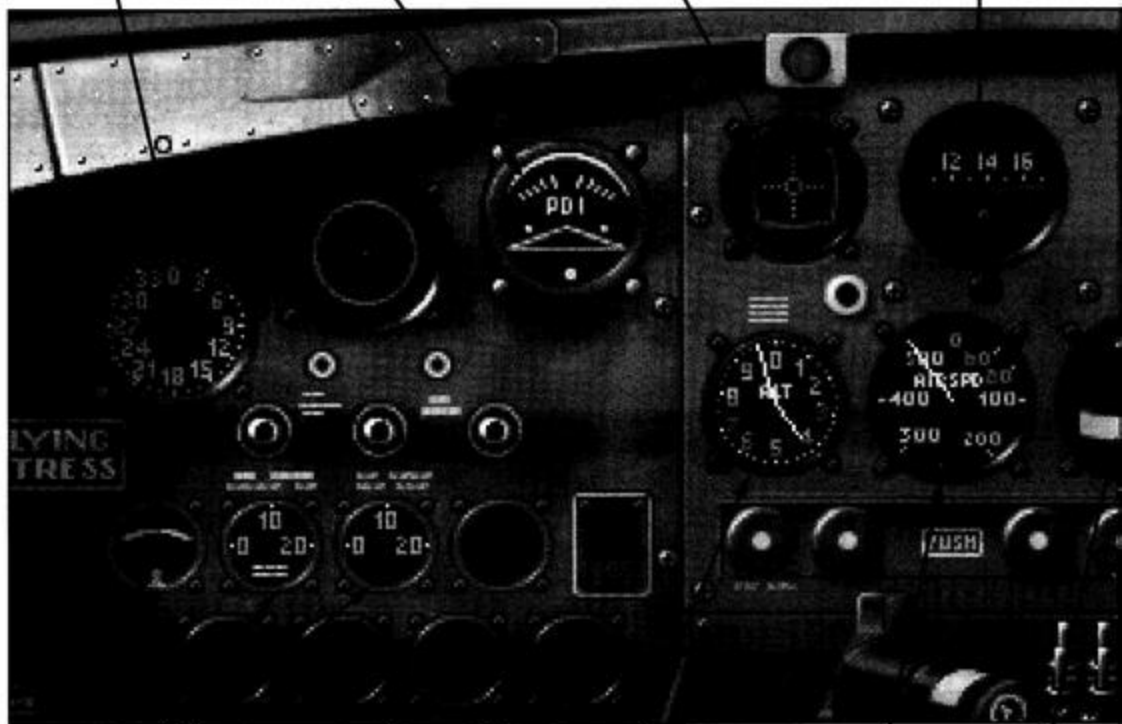

Emergency Oil &  
Hydraulic  
Pressure Gauges

Pilot/Co-Pilot  
Oxygen Flow  
Indicators

Altimeter

Airspeed  
Indicator

Turn and Bank  
Indicator

## THE PILOT'S INSTRUMENT PANEL

### The Pilot's Control Column

A Joystick *Controller* is recommended for flying the B-17 but you may also fly it using Keyboard and Mouse *Controllers*.



Flight Indicator      Manifold Pressure Gauge (2)      Oil Pressure Gauge      External Air Temp.

Tachometers  
2 Engines per dial

Fuel Pressure  
Gauges (2)

Fuel Quantity  
Gauge



Rate of Climb  
Indicator

Tail Wheel  
Lock

Cylinder  
Head Temp  
Gauges (2)

Oil Temp  
Gauges

Landing Gear  
Indicator Lock

Brake Light

Flap Position  
Indicator

Carburettor Air  
Temp Gauges (2)



## The Instrument Panel

Study the diagram of the Pilot's Instrument Panel. It's important that you are familiar with the location of all dials and switches. Take particular care to understand the function of:

### *The Altimeter*

This dial shows height above sea level. The long dial shows hundreds of feet and the shorter dial thousands of feet. Always be aware of your flying height and keep an eye on this dial.

### *The Directional Gyro*

This dial will show you your heading. A heading of  $0^\circ$  is North,  $90^\circ$  is East,  $180^\circ$  is South and  $270^\circ$  is West.

### *The Airspeed Indicator*

This dial tells you the speed of the aircraft through the air in Miles Per Hour from 0 to 500 mph.

### *The Rate of Climb Indicator*

A visual indication of climb/dive angle shown as hundreds of feet per minute. Pointer on 0 means Level Flight.

### *The Landing Gear Indicator*

A visual indicator that the Landing Gear has been raised or lowered. In event of damage you may have to operate the gear manually.

### *The Flaps Indicator*

Flaps are the trailing edge of the wings that when lowered, enable the aircraft to get extra lift at take off and slow down for a landing.

You must also be aware of the following functions:

## **MOVE CONTROL COLUMN ELEVATOR, AILERONS (JOYSTICK, CURSOR KEYS)**

*Ailerons* are lateral control flaps at the rear of the airplane main wing tips. Raised or lowered by moving the Control Column left/right will make the plane turn to the left or right.

*Elevators* are the horizontal portions of the tail. When pushed up/down by pushing the Control Column up/down will make the plane dive or climb.



## RUDDER LEFT/RIGHT (<>)

*Rudder* controls left/right will swing the nose of the plane left/right by moving the trailing edge vertical segment of the tail left/right.

## THE FOUR ENGINES

The *Flying Fortress* is a large four-engined bomber and this simulation provides separate controls for each of the four engines. These enable player to 'feather the props' (turn the engines off and the propeller blades end on) in the event of fire or malfunction, extinguish fires and alter individual throttle settings. Engine number 1 is the left outboard engine from the Pilot's View followed by 2,3,4 in sequence.

*All numeric keys are on the top row of the main computer keyboard.*

<b>1, 2, 3, 4</b>	Increase power on individual engines 1-4
<b>Shift/1, 2, 3, 4</b>	Maximum power on engines 1-4
<b>5, 6, 7, 8</b>	Decrease power on individual engines 1-4
<b>Shift/5, 6, 7, 8</b>	Minimum power on engines 1-4
<b>Plus Key +</b>	Increase power on all engines
<b>Shift/Plus Key +</b>	Maximum power on all engines
<b>Minus Key -</b>	Decrease power on all engines
<b>Shift/Minus -</b>	Minimum power on all engines
<b>Ctrl/1, 2, 3, 4</b>	Start/Stop (feather) engines 1-4
<b>Alt/1, 2, 3, 4</b>	Fire extinguisher on engines 1-4

## OTHER PILOT CONTROLS

Note that any control that starts a motor will take time to function. Its effect will not be instant.

<b>Key G</b>	Landing Gear Up/Down (starts motors)
<b>Key F</b>	Flaps Up/Down Toggle
<b>Key B</b>	Brakes On/Off
<b>Key D</b>	Bomb Bay Doors Open/Closed (starts motors)

NB The following is a guide to take off/flight/landing. For more detailed information please consult the **Flight Supplement** in the *Flying Fortress Technical Supplement*.



## THE TAKE OFF

You will begin every mission in the Pilot's seat in player control.

In each mission your B-17 is the last element in a 3 plane 'V' that will assemble in a flight of 6 or 9 Fortresses depending on the formations to be flown. The other planes will already be in the air assembling in formation. You must take off and join them before they can set off for the target.

### Starting Engines

Start all four engines in the sequence (**Ctrl/1, 2, 3, 4**).

Increase the Engine Throttle Controls (**1, 2, 3, 4**).

Release the Brake (**B**).

The B-17 will now begin to move.

Check that you can easily flip from Pilot's Instrument Panel (**Key I**) to Window View (**Key W**) to see flight information.

### Taxiing and Steering

Steer the B-17 by using your *Controller*. Gentle left/right will produce a slow turn in the chosen direction.

Stay on the correct path. Do not stray onto the grass.

Steer the bomber carefully to the edge of the take off runway. Try to line up the B-17 along the white dotted line.

### Flaps

Check that Flaps are Down (**Key F**).

### Taking Off

Apply maximum power to all four engines (**Shift/Plus +**). Do not try to pull the plane into the air. Normally, when you reach an Airspeed of 110-115 mph a gentle 'pulling back' on the *Controller* will allow the plane to lift itself off the ground. The B-17 controls may feel sluggish compared to other flight simulators, but remember that this is a big, heavy airplane.

After the airplane has left the ground, and you are sure that you have sufficient flying speed, raise the Landing Gear (**Key G**). Check that this has happened with any appropriate Outside View.



After reaching an airspeed of 130-150 mph, adopt a normal climb attitude with the Rate of Climb Indicator pointer at 200-300 hundred feet per minute and watch the Altimeter rise gently.

## CLIMBING AND CRUISING

The rate at which an airplane will climb is obtained directly from the difference between the power required for level flight and the power available from the engines. This is the *reserve power* that is available for climbing.

Make your climb at 130-150 mph. Remember decreasing atmospheric pressure as you climb causes the airspeed indicator to show an airspeed lower than your true airspeed.

The turbo superchargers will come on automatically as you gain altitude. The booster pumps will operate after you have passed 10,000ft and the crew will wear oxygen masks above this altitude.

Smooth steady flying is very important. This will cut fuel consumption, increase rate of climb and reduce engine wear. Always keep one eye on the instruments. They are there to tell you how your plane is performing.

Continue your climb to about 300 feet above the desired cruising height (in *Mission Briefing*), level off, drop the nose slightly and you will pick up speed. Reduce power to your cruising setting. Drop to cruising altitude gradually.

Change Flaps to Up (**Key F**).

## FLIGHT CHARACTERISTICS

### Turns

The B-17 has good directional stability. Dropping one wing will produce an effective turn.

In shallow turns load factors are small, but this increases as the turn gets steeper. Banking at 10° produces a load factor of 1.5, but at 70° this becomes 3.0. In a heavily loaded aircraft this could cause structural failure.

### Stall and Recovery

The B-17 has good stall characteristics. The tendency to roll is minimised by the large vertical tail.

To recover from a stall dive at about 30° and regain airspeed for normal flight. The primary aim is to recover from the dive smoothly. Excessive diving to regain airspeed is unnecessary.





## Spins and Dives

It's extremely difficult to accidentally spin the B-17 because of its directional stability. Diving the plane presents no danger but be aware that recovery from a dive must be smooth and gradual.

## FORMATION

Once you have joined the other planes of your squadron in formation, the flight will strike out towards the first Waypoint. You are not the leader of the formation so if you choose to drop out of formation, for whatever reason, the others will not follow you.

## ACCELERATE TIME (ALT/A)

You may choose to speed up the time it takes to travel to the target by pressing **Alt/A**. Keep the buttons pressed and release if you wish to return to normal time.

## SKIP TIME (ALT/T)

You can choose to lose chunks of time when nothing happens by accessing this function. If anything dramatic does happen *Skip Time Function* will stop and you will be returned to normal time.

## LANDINGS

At the lowest level of difficulty it will be sufficient if you can touch down on the runway. However, if you do not wish to land the plane but want to remain in Pilot's view you can press **Key M** and let the computer-controlled Pilot take over all landing functions.

### Traffic Pattern (for realistic landings)

On most B-17 bases the traffic pattern (the flight path to line up for *Final Approach*) is rectangular in shape. Fly a large rectangular path over the airfield at about 800-1000 feet in altitude. Fly the pattern at 130-150 mph IAS. Lower flaps (**Key F**) when you turn on to the base leg (the last turn before final approach) and keep your airspeed down to 110-120 mph.

You may receive messages from the ground control tower to direct you down. It may happen that you will have to circle waiting for other squadrons to land. Be patient and check that all the crew are in their correct landing positions.



If you are attempting a crash landing you should place all crew except the pilot in the Radio Compartment. There will be less chance of injury there.

Drop Landing Gear (**Key G**). Check that this has happened. If gear motors are not working go to the Manual Landing Gear Icon in the Pilot's *Compartment Screen*.

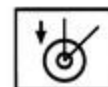

## Final Approach

The approach is basically a controlled glide, with flaps down, and in which power is used to maintain an accurate landing position.

Reduce power gradually (**Minus Key -**) until the desired airspeed (about 110-120 mph) and rate of descent have been established. Touch down gently trying to land all wheels on the runway at the same time. Drop to minimum throttle.

## Landing Roll

When you have landed make sure you use the entire runway for the landing roll. Do not apply the brakes too early. Apply the brakes (**Key B**) when you feel the plane slowing down from its roll. The B-17 should then slow down and stop.

Once you have landed, the mission is effectively over and you will leave your B-17 for *Mission Debriefing* and *Medals and Promotions*.

## Good/Bad Landing

At the higher levels of difficulty a good landing will help your prospects for promotions and medals. A dangerous landing will not only damage your bomber but also reduce the morale of your crew and make them less effective in future missions.





**The Bombardier**



# THE BOMBARDIER

## ACTION VIEWS

By selecting the Bombardier photo (first left, top left), the Bombing Icon and pressing **Key C** from the *Compartment Screen* you will enter the Bombardier's position. Here you will be able to choose from 3 Bombardier action views:



### The Bombsight View (Key I)

Looking through the Norden Bombsight at the ground detail below with 4 indicator lights for Bomb Sight Active, Bomb Doors Open, Bomb Release Cue, Bombs Gone. This is the view you should go to when approaching the target.

### Window View (Key W)

This option allows a view out of the Plexiglas nose section from the Bombardier's position.

### External View (Key E)

This option allows an external view of the B-17. (Press **Key W** to return to Window View).

### Returning to Compartment Screens (Key C)

You can always return to the *Compartment Screen* by pressing **Key C**.

## BOMBARDIER'S CONTROLS

Press **Key M** to assume manual control.

### Bomb Bay Doors (Key D)

Starts the motors to open/close the bomb bay doors.

In the event of damage, the doors can be opened *manually* by returning to Compartment View (**Key C**) and choosing a crew member to go to the Bomb Bay Compartment. Three Icons will appear that enable that crew member to



and manually trigger the dropping of the bombs

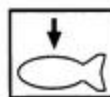

When you are in the Bomb Bay you may view Bomb Bay operation by pressing **Key C**.





## Bombsight Controls

Bombsight On/Off **Key O**.

Key O will turn the bombsight On/Off and allow control of the plane via the bombsight. But you must have already assumed manual control of the Bombardier **Key M**.

Your *Controller* (Joystick, Cursor Keys) will adjust the bombsight tracking motor speeds left/right and up/down.

To release the Bombs press [**Space/Return/orSelector**]

## IDENTIFYING THE TARGET

When the bombing force is an appropriate number of miles from the target there will be a warning issued from Bomb Group Leader. If you are intending to be the Bombardier (and the rewards will be greater if you are), give yourself plenty of time to get into position and familiarise yourself with the bombing controls. Press **Key M** for manual control.

The primary aim of the mission is to drop the bombs on the correct target accurately and promptly. Be sure that you have identified the target correctly and take care to line up the B-17 in the correct bomb run. The Bombardier will need at least 20 seconds of level flight to track the target. The bombsight cross hairs must stay on the target until the Bomb Release Cue lights up. You must try to forget about the flak and enemy fighters during this time.

### Primary

This is your main objective and will earn you better rewards and promotions if you achieve it. Study details of the target and be aware of what to look for.

### Secondary

If the *Primary* is impossible you must switch to the *Secondary Target*. This will often be a lower priority target and will be not very far from the *Primary Target*. Issue the *Abort Primary Target* Message on the radio and set the new heading.

Random ill-directed bombing will be penalised. However, if bombs are jettisoned to preserve the safety of the crew and the bomber there will be no penalty imposed by Bomber Group.



## BOMBING PROCEDURE

### The Ideal Line

Make sure the target is lined up perfectly with the cross-hairs on the bombsight. Try to aim for the centre of a block or rectangular building. You will have to keep the target in the cross hairs for a minimum of 20 seconds by using your *Controller*. When the Bomb Release Cue lights up, release the bombs by pressing the *Selector*.

### Overshooting the target

There may be occasions when the cue light will not come on, even though you have kept the cross hairs in the correct position. This may be because the bomber is too close to the target and dropping the bombs will mean they will overshoot it. You will have to go around again.

### Random Targets

Make sure you are tracking the *correct target*, the cue light will come on even if you track any normal buildings; it does not know what your correct target looks like. It is only there to tell you that the bombs will hit *the target you are tracking* if you release at that particular point.

### Go Around Again

If you fail to hold the bomber on target you may find that you can transmit a radio message to the rest of the formation to go around again. If no message is available you will have to transmit Abort and go to the *Secondary Target*.

## THE BOMBING FORMATION

The rest of the squadron will bomb with you as long as you remain in the formation. If you choose to leave formation or have to drop out because of mechanical difficulty the others will not stay with you. You may be able to repair damage and try to find the formation again.

## THE NORDEN BOMBSIGHT

Keep Target in Cross-Hairs

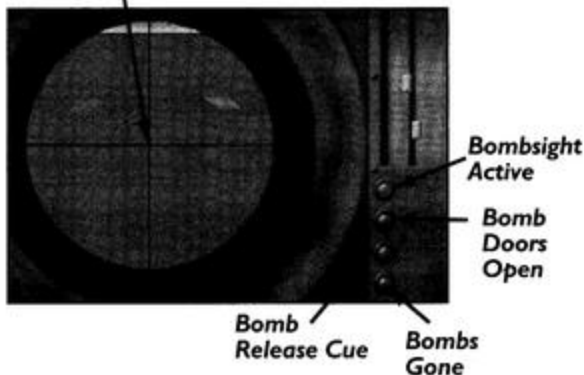





## DAMAGE

If the bomb bay doors or bomb sight are completely out of action and the bomber goes to the target, the Commander will be credited with a 'Near Miss'. Carrying on with the mission, under adversity is recommended for Rewards and Promotions.

## BOMB BAY VIEWS

If you wish to see the bomb bay opening/closing and the bombs dropping from inside the compartment, then you must take a crew member to the bomb bay using the

Move Crewman Icons.



**Key C** will give you a down view of the bombs, **Key E** will give you an external view and **Key W** will return you to bomb bay view.

## Tactical Views of Bombs (Shift F7/Shift F8)

If you wish to follow the bombs dropping on to the target you can do so by using Tactical View and Reverse Tactical View. You may have to Zoom In/Out (**Pad Plus +/Pad Minus -**) and pitch/rotate to get the best view of the bombs hitting (or missing) the target.

## ON/OFF TARGET

A mission is deemed successful by the amount of damage done to target. If a Commander does not drop the bombs on the correct place the mission will be classed a failure. Also, you must be the one to drop the bombs: if a computer-controlled crewman drops them, the player will only receive minimal credit.



An aerial, black and white photograph of a city grid. A large, dark shadow is cast across the grid, originating from a structure on the right side of the frame. The shadow is elongated and follows the path of a street. The text "The Navigator" is overlaid in white on the upper right portion of the image.

# The Navigator



# THE NAVIGATOR

The Navigator's Panel is accessed by selecting the Navigator's photo (second from the left, top left section), selecting the Navigation Icon on the Nose Section *Compartment Screen* then pressing **Key C**.

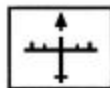

## VIEWS

### External View (Key E)

A general external view of the B-17

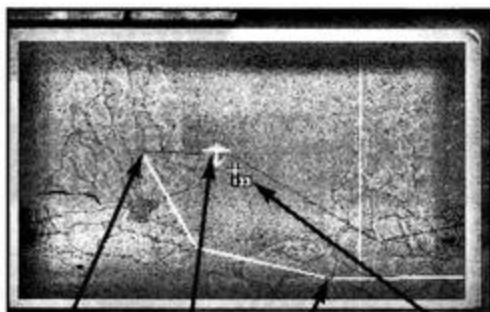

Take Off Estimated Position Waypoint Bearing

## THE MAP

You are placed in the Navigator's seat and have a scrolling view of a map of Europe open on a table in front of you. This shows the mission route as detailed in the *Mission Briefing*. The Navigator can access *Mission Briefing* details by pressing **Key B**.

## SETTING COURSE

The route to and from target with all Waypoints is already marked on your map. An aircraft marker shows the *Flying Fortress* estimated position and bearing. A navigation marker shows the bearing from the estimated position to the marker.

## CONTROLS

### Estimated position

Normally you will not change your estimated position. The position estimated by your Navigator may not be 100% correct but be careful setting a new course. You must be sure of exactly where you are before you reset any navigation markers or you will risk getting lost.



## Wounded Navigator

If your Navigator is injured and unable to continue in his position, he will not be able to estimate the B-17 position and the aircraft marker will cease to move along the target routes. If you are in formation, stay with the formation and they will lead you to the target and return to base. Choose the member of the crew who has the best navigation skills to take over.

## Fixing your Position

If you are out of formation, you will have to find out where you are and fix that position on the map. Be extremely careful doing this for if you fix an incorrect position you will find it very difficult to get back to base. You will have to fly low over recognizable features such as rivers, bridges, and ports.

Move the Navigation marker with *Cursor Keys/Mouse Controllers*.

Fix your estimated position by moving your *Controller* across the map and clicking with your *Selector*. The aircraft symbol will move to where you have set it. Remember that the bearing you get from the aircraft cursor will be the reading from your *estimated position*.

## System Damage

If your navigation system is completely out of action you will have to navigate home using ground features, the map and compass readings.

Return to *Compartment Screen* by pressing **Key C**.







# The Radio Operator and Intercom Systems





# THE RADIO OPERATOR AND INTERCOM SYSTEMS

The Radio Operator can be accessed by selecting his photo (second from the left, bottom right of the screen), the Radio Icon from the Radio Room *Compartment Screen* and then pressing **Key C**.



Here, you will be able to send receive and monitor all messages to and from base or other bombers in the formation.

## VIEWS

The view shows a log of important events and messages received or messages available for transmission.

## RADIO OPERATOR CONTROLS

The log book has a series of Icons with which the player can access messages received, times received and a history of the mission. You can select Radio Transmit and click on a series of messages that appear at appropriate times during the mission for transmission.

Messages are recorded in the order sent and received during flight and can be retrieved and read. If anyone else takes the position of Radio Operator without high technical skill some messages may not be recorded.

The Mouse/Cursor Keys *Controller* can be used to move a pointer and click on various Icons/Messages that appear to the side of the log book.

**Display message/event log**

**Display radio message menu**

**Select radio message for transmission. (Selected message is highlighted.)**

**Transmit selected message**



## THE INTERCOM

The Intercom operates from all internal bomber views/screens and provides simple messages about internal/external events. The messages appear in a pop-up window, usually with a photo of the issuing crew member.

### External messages

A series of messages about external events such as enemy fighter attacks will be displayed on the intercom for example:

**[Aircraft] at [Clock position] [Height]**

**[Parachute at [Clock position] [Height]**

**Flak at [Clock position] [Height]**

**Aircraft = B-17, Escort or Fighter**

**Clock = 12 o'clock [ahead], 6 o'clock [behind] etc.**

**Height = High, level, low relative to bomber**

### Internal Events

A series of messages about internal events will be displayed for example:

**[Crew member] wounded**

**[Crew member in relevant compartment] reports [bomber system] problem.**

**Reports of damage to wings and engines are reported by Co-Pilot.**

**[Crew member] now in [Compartment]**

**[Crew member] manning [Gun position]**

**[Crew member] treating [Wounded crew member]**

**[Crew member] repairing [Bomber system]**

**[Navigator position crew member] reports bombs away!**

**[Ball Turret Gunner position crew member] reports bomb doors open!**

**[Ball Turret Gunner position crew member] reports bombs away!**

**[Radio Operator position crew member] reports incoming message.**

NB The model B-17 you are flying does not have a Radio Room gun position. The gun was dispensed with in May 1944 as being the least used in action.





# Crew Management Systems



# CREW MANAGEMENT SYSTEMS

## INTRODUCTION

The crew of the B-17 are specialists in their particular skill but have to be prepared to do each others' jobs in the event of injury. The player, as Commander, must be able to manage the crew and re-allocate them to other positions in an emergency. Special skills must be studied by the player and choices made when the need arises.

Consult the individual Crew Files at any time by selecting this Icon from any of the *Compartment Screens*.



At the start of the simulation the 10 man crew will be in their correct compartments but not in position (the Ball Turret gunner will be in his take off position in the Radio Compartment). Assign them to their particular jobs as detailed in the *Bomber Operation* section.

## VIEWING THE TEN CREW POSITIONS.

Once all positions have been assigned to the ten crew members, the player can choose to view any one of them by pressing **Function Keys F1 to F10**. This is also a shortcut to access all game positions quickly without going through the *Compartment Screens*.

**F1** Bombardier

**F2** Navigator

**F3** Pilot

**F4** Co-Pilot

**F5** Engineer/Top Turret Gunner

**F6** Radio Operator

**F7** Ball Turret Gunner

**F8** Left Waist Gunner

**F9** Right Waist Gunner

**F10** Tail Gunner

If your current view is not a Crew View (for example, you are watching an enemy fighter) **Key C** will return you to the last selected crew member.

## 'JUMPING' INTO POSITION

The player can also choose to 'jump' into any crew members position. **Key M** will toggle computer/manual control of crew positions (except Navigator and Radio Operator). In fact, the rewards are greater if the player is the one who has aimed the bombsight, dropped the bombs and shot down most of the enemy planes.



## CREW SKILLS

Crew Skills are shown in the crew files. These consist of:

**Gunnery**

**Bombing**

**Technical**

**Medical**

**Piloting**

Crewmen who survive missions become better at their job. Replacement crews, while still being specialists, are never as good at their jobs. Thus the continued good health of the original crew is very important to the *Flying Fortress* Commander.

## RE-ALLOCATION OF CREW TASKS

The player is free to move individual crew members to any other available positions. You may move all the crew into one compartment (if you so wish) or switch their jobs about. As Commander, it is up to you how the *Flying Fortress* crew is allocated. Be careful not to leave the plane 'pilotless'; it will continue to fly on Autopilot but in a straight line set by the last pilot.



## Crew Status Indicator

### *The Photo*

The crew photos in the *Compartment Screens* will show one of three conditions:

**Grey-Out** Crewman not in compartment.  
(Select the photo to move to his compartment).

**Photo** Crewman there, in position.

**Red Border around the photo** Crewman selected by player.

**2D Picture**

**Move  
Crewman  
Icons (Select  
Crewman  
First)**

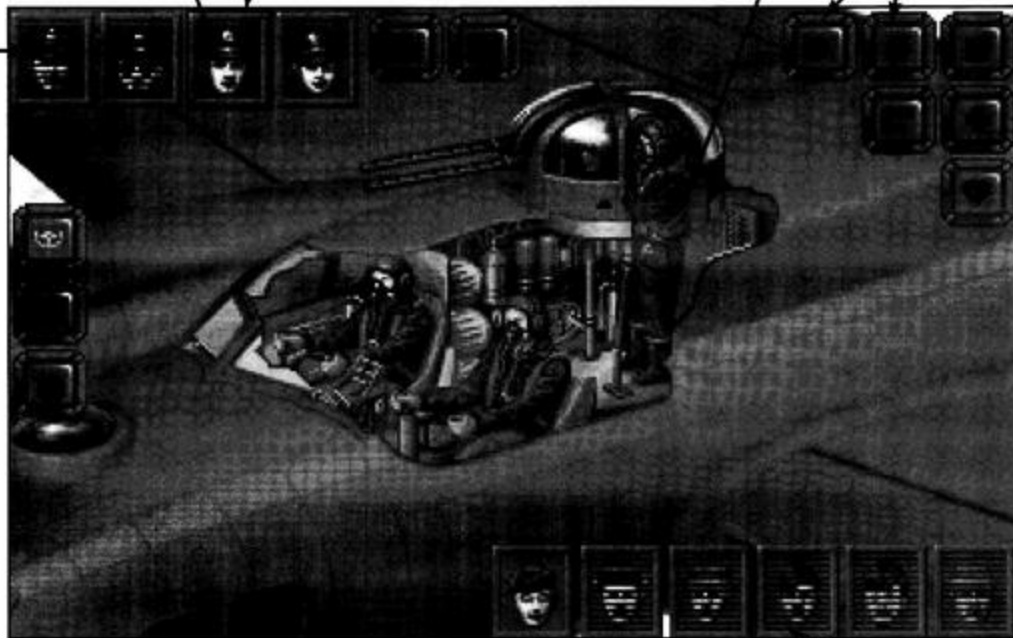

### **PILOT'S COMPARTMENT SCREEN**

#### *The 2D Picture*

In addition, crew positions will be filled by a picture of the crew members in that particular compartment cut-away.

If there are more crew in the compartment than there are positions, a generic (general representation) crew member picture will appear standing in the section, with a red indicator showing the number of crew members he represents. Thus, if there are three spare men in the compartment who have no job to do the generic crew man will have a number 3 on the indicator.

**Select Photo to Move to  
Other Compartments**





## Moving the Crew Around

Select the crew member you wish to move by clicking on his *Photo* or on the *Picture*.

The *Photo* will show a red border. Now, select one of the

Move Crewman Icons



in the top right part of the screen. The cut-away *Compartment Screen* will be replaced by the next one along, effectively taking the chosen crew member into that part of the plane.

Select the position for him to fill by clicking on a crew 'job' icon. If the position is already occupied then that crew member will step out of his position and let your chosen character take over. He will now be occupying that position. But remember the previous occupant will still be in that compartment awaiting instructions.

Check that the changeover has happened by looking for the red border around the newly arrived crew member's photo in that *Compartment Screen*.

## Time to get there

If you decide to move the Bombardier to the Tail Compartment then, although *you* can jump to that section quickly, you may have to wait a little while, for the Bombardier to physically get there.

## Player Control/Computer Control of Crew Member (Key M Toggle)

You can choose to take over control of the crew member from the computer by pressing **Key M**. Press the keys again to switch back control or simply leave the position **Key C**.

## CREW HEALTH

### Wounded and First Aid

It pays to keep your crew healthy. If a crewman is unconscious you cannot jump into his shoes and, if his position is important to the success of the mission, you will have to find someone else to take over.



Photos on the *Compartment Screen* will have red crosses marking which members of the crew are wounded and the Compartment Picture will change to show the crewman slumped in his position.

Select a crewman to administer First Aid.

The chosen crew member will have to be taken (using the Move Crewman Icons) to the correct compartment to administer First Aid.



Select the First Aid Icon



and you will be shown the state of health of all crew members. Click on the crew member you wish to help. There will be occasions when more than one member of the crew will be injured. It is your decision as Commander as to who gets treated first.

If you wish to stop a crew member performing any job, or wish to use him for any other task, simply click on his job Icon and the button highlight will be turned off. He will stop doing that job.

## Landings

If you have wounded on board, and are playing at the higher levels, you must take particular care when landing the B-17. Bad landings can affect injured crew adversely and may keep them from returning to combat status for a long time. Try to move all the crew except the Pilot into the Radio Room, this is the safest place for crash landings.

## Oxygen System

All crew members are 'on oxygen' above 10,000 feet, thus if damage occurs to the oxygen system the bomber has to drop below that altitude or risk serious injury to everyone aboard. An Intercom message will appear directing the Pilot to do this.

## Heating System

Damage may occur to crew heated flying suits or compartment heating ducts, again altitude must be reduced to below 10,000 feet or there will be a risk of serious injury.

## Medals

Any wounded crewman automatically receives the Purple Heart at the end of the mission. It will appear in his crew file.







**The Gunners:  
Defending the B-17**



# THE GUNNERS: DEFENDING THE B-17

## THE CLOCK SYSTEM OF DEFENCE

All the Gunners will be on the look-out for enemy fighters. If a squadron is seen by any member of the crew he will call out on the Intercom giving a clock reading and

a level. Study the Clock System. The nose of the plane is pointing to 12 o'clock, the tail is pointing to 6 o'clock, the starboard (right hand) wing to 3 o'clock and the port wing to 9 o'clock. If the Intercom tells you that there are 'Bandits at 11 o'clock high' you will know that they are high above the port cheek gun.

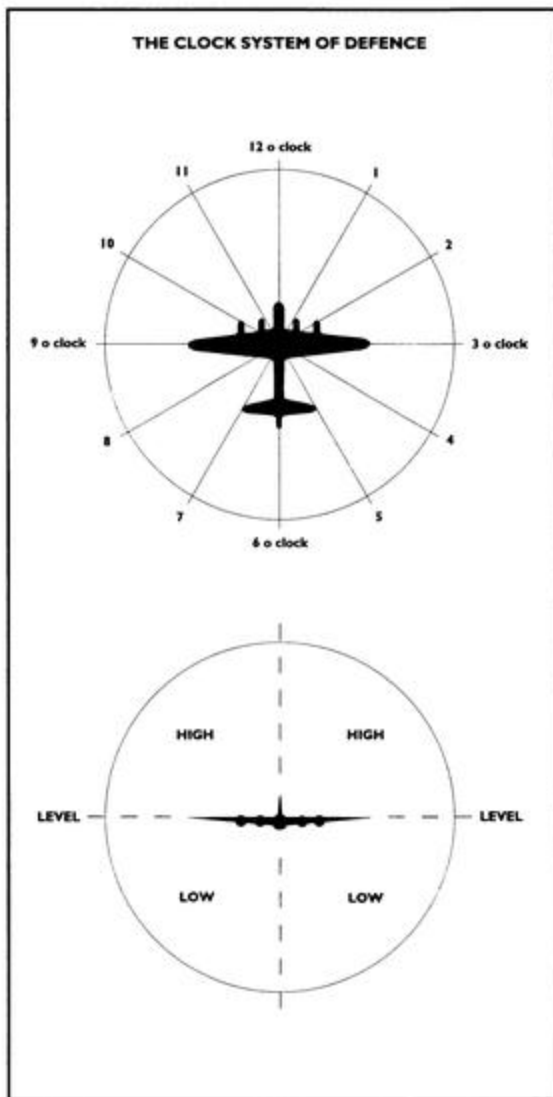

## Gun Positions

The B-17 has eight gun positions available to the crew. These can all be accessed by selecting the gunner, the relevant Icon on each of the *Compartment Screens* and pressing **Key C**. The guns available are:

- Front (Chin) Turret Gun
- Starboard Cheek
- Port Cheek
- Top Turret
- Ball Turret
- Starboard Waist Gun
- Port Waist Gun
- Tail Gun

**Key M** will toggle manual/computer control of the guns.

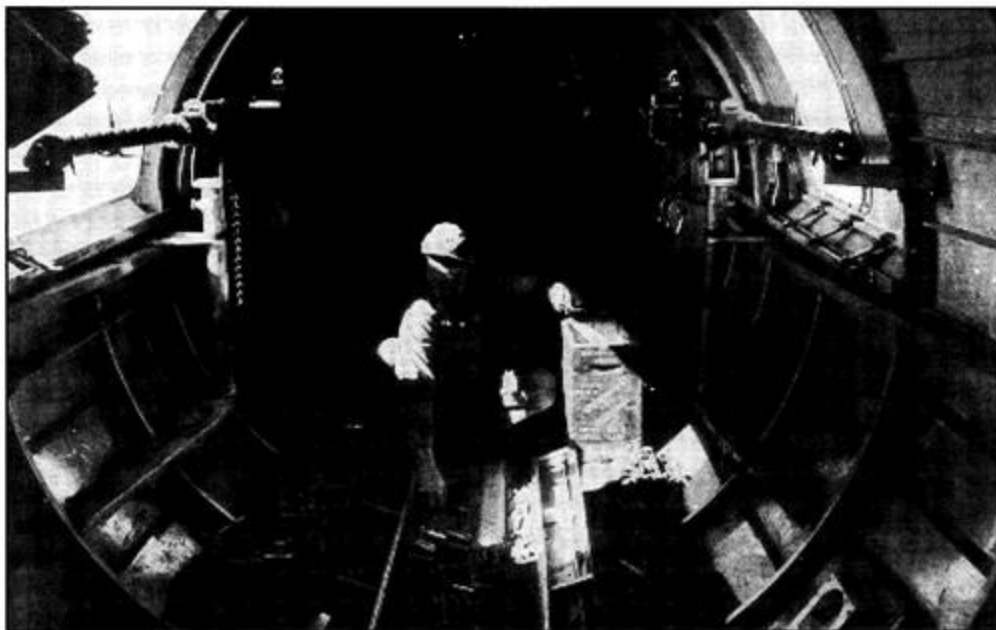

*At the end of a mission a member of the ground crew picks up spent cartridge cases scattered around the waist guns of a Fortress. The two Browning 0.50 calibre machine guns are in their post mission positions.*

Shooting down enemy aircraft will contribute to mission success but only if the player has taken over guns.

Aircraft always gets a painted reward marking even if the enemy fighter was shot down by the computer controlled crewmen.

## **VIEWS**

Gunners have no Instrument Views but have a view out of their turret/gun position showing guns (where applicable) and the gunsight.

## **THE MACHINE GUNS**

### **Controls**

*Controller* (Cursor Keys/Joystick) Move turret/gun.

Position sighting reticule on the enemy fighter

The **Shift Key** will give fine tracking control on the target.

Fire using the *Selector* (Joystick Button/Space/Return).





## Jammed Guns

**Key U** Unjam gun (manual control).

If you are controlling the guns manually and the guns jam, **Key U** may allow you to try to unjam that particular gun.

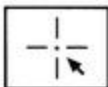

Unjam Gun (from *Compartment Screen*).

Guns can also be 'unjammed' by selecting the Unjam Gun Icon in the *Compartment Screens*.

## Sights/Aiming/Deflection

The best way to become a good Gunner is to practise. You will find that in the heat of aerial combat, there is not a great deal of time for extremely accurate aiming. Pressing the **Shift Key** will allow fine control of target tracking but in many cases you may have to fire a stream of bullets and hope one of the enemy fighters crosses it. Remember to follow the tracer path and get an idea of the deflection produced by speed and gravity.

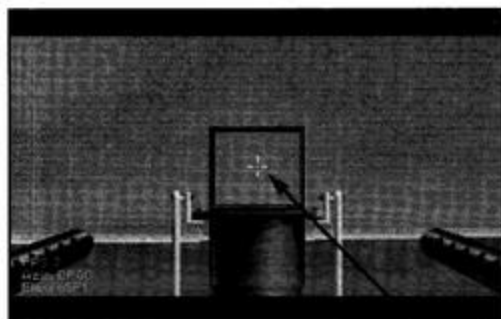

**TOP TURRET GUN VIEW**

Gunsight

## DROPPING OUT OF FORMATION

If you leave the formation for any reason you may be vulnerable. You will lose the all-round defensive network of the Group and will probably be hunted by enemy fighters. Flak units will have just you as a target and concentrate on your bomber. Your chances of survival will be reduced.

## ESCORT FIGHTERS

If you do have fighter escort on your mission they will be out of your immediate sight but will be diverting the attention of enemy fighters who are looking for you. The enemy planes that have got to the main formation will have already battled past your defensive escort fighter screen.





# Damage Systems





# DAMAGE SYSTEMS

## BOMBER DAMAGE

### Aircraft Status Screen (Key A)

You may view the Aircraft Status Screen by pressing **Key A**. This is a quick overview showing any damage sustained by the bomber.



The pilot of a B-17 sitting in the gaping hole of the tail section after having flown the plane home safely. Damage was inflicted by a Fw 190 during a raid on the U-Boat base at St. Nazaire, occupied France.

### Fires in the B-17

If a system is damaged, it may be possible to repair it. If, for example there is a fire in any Compartment you can send a crew member to try to put it out using the

Fight Fire Icon



Select the crew member to fight the fire, select the Move Crewman Icon to take him to the compartment (if it is not his own) and then select the Fight Fire Icon. This will not always succeed and may depend on the severity of the fire.

### Engine Fires

If an engine is on fire you can try to put it out from the Pilot/Co-Pilot Controls by using **Alt/1,2,3,4** dependant on which engine is on fire. (Remember that engine No.1 is on the extreme left of the Pilot, and engine No.4 on the extreme right).

### Turret Repairs

If a turret is not working you can send a crew member (as above) to the *Compartment Screen* and select the

Repair Turret/Guns Icon

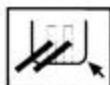

If the Ball Turret jams, it cannot be unjammed from within. The crew member is stuck inside until you can allocate someone to unjam the turret from the fuselage.



## Bomb Bay Doors

In the event of damage to the motors of the Bomb Bay Doors you can still open and close the doors manually by sending a crew member to the Bomb Bay Compartment and selecting the

Open Bay



Drop Bombs

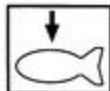

or Close Bay Icons



## Landing Gear

In the event of damage to the motors of the Landing Gear you can still lower and raise the gear manually by selecting a crew member and clicking on the Lower Gear/Raise Gear Icons from the Pilot's *Compartment Screen*.

## CRASH LANDINGS IN OCCUPIED TERRITORY

If you crash in occupied territory then you may lose some of your crew (depending on the difficulty level chosen) and will either be taken as a POW or be able to escape with help from the Resistance. In all cases you will lose time, and morale among the remaining members of the crew will be low.

## CRASHES IN UK TERRITORY

You will be able to return to your own base quite quickly. Your crew may suffer injuries or wounds may be aggravated by the crash. It may help if you issue the correct radio message before crashing so that the wounded will not have to wait too long for medical assistance.

## BAILING OUT (ALL CREW)



The signal to bail out can be given at any time to your crew simply by selecting the Bail Out Icon on one of the *Compartment Screens*. It is a serious matter to bail out of a B-17 and once you issue the order, everyone will respond. There is no turning back. You will



lose your bomber and may injure your crew in a dangerous landing. If you are inside friendly territory you may be able to issue a radio message warning rescue services of your position.

## **DITCHING IN THE SEA**

If you are going to ditch in the sea, you will be much more difficult to find. Remember to transmit a radio message to the rescue services.

It is recommended that, in the event of an anticipated crash landing, you move all the crew (except the pilot) into the Radio Compartment.

## **GETTING BACK HOME**

### **POW**

It is possible to escape from a POW camp and get back home but all this will take time.

### **Escape with help from Resistance**

The resistance fighters in occupied Europe will help you escape back to Britain if you land up in their hands.

## **REPLACEMENT BOMBERS**

The *Bomber Roster Screen* will be updated. New Bombers will appear for you to pick and name.







# End of Mission





# END OF MISSION

## DEBRIEFING

At the end of the mission when the bomber has landed you will be given a summary of what happened during the raid.



*A reconnaissance photo taken a few hours after Flying Forts had bombed the huge Messerschmitt factory at Regensburg. Ruins are those of the factory; the untouched buildings in the plot on the left are those of an hospital.*

## Target Damage

The scale of damage inflicted on the target will be shown.

There are four types of target damage: Direct Hit; Superficial Hit; Near Miss; and Complete Miss.

The damage radius of each bomb varies according to the difficulty levels chosen. Bombs from the player's own aircraft are the most important for mission success.



## **ABORTED MISSION**

You can choose to abort any mission by issuing the correct message from the Radio Compartment.

### **Justified Abort**

If you have aborted a mission because of any justifiable reason such as mechanical failure, no action will be taken against you.

### **Unjustified Abort**

If you have aborted a mission for no good reason you may have to face the consequences.

## **CREW CHANGES**

Crewmen who survive missions become better at their job and will always exceed the skill levels of any replacement crews. Continued good health of the original crew is thus very important.

During the mission any successful use of skill by a character is recorded and rewards and promotions issued accordingly. Wounded crewmen will recover over time and re-appear on the crew list.





# Medals and Promotions







# MEDALS AND PROMOTIONS

## MEDALS

In *Flying Fortress* Medals are awarded for single outstanding missions. The decorations available are:



### Congressional Medal of Honour

The Congressional Medal of Honour is America's highest military decoration. Awarded for conspicuous gallantry above and beyond the call of duty, in action involving actual conflict with an opposing armed force.

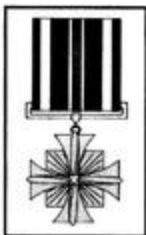

### Distinguished Flying Cross

Awarded for heroism or extraordinary achievement while participating in aerial flight.



### Distinguished Service Cross

Awarded for extraordinary heroism in connection with a military operation against an opposing armed force.



### Silver Star

Awarded for gallantry in action against opposing armed forces.



### **Bronze Star**

Awarded for gallantry in action against opposing armed forces.



### **Purple Heart (awarded automatically to wounded crew)**

This medal is awarded to servicemen who are injured or killed as a result of an act by an opposing armed force.



### **The Air Medal**

Awarded to any crew member who has completed 25 missions.

## **PROMOTIONS**

Promotions are available to all members of the crew for outstanding or consistent performance during one or several missions. Promotions run along two scales: officers and enlisted men. All crew members start at either Sergeant rank or Second Lieutenant.

### **For Officers (Pilot, Co-Pilot, Bombardier, Navigator)**

Second Lieutenant

Lieutenant

Captain

Major

Lieutenant Colonel



## For Enlisted Men (All Gunners, Radio Operator, Engineer)

Sergeant

Staff Sergeant

Technical Sergeant

Master Sergeant

First Sergeant

After a successful mission you will return to the *Crew Photo* screen where you will be told if you can make a number of promotions or award decorations. Follow any on-screen prompts. You need not use all the rewards available but may reduce crew morale if you fail to do this.

After the reward screen you will returned to the *Crew Photo* screen where unavailable (injured) crew will fade out until they recover. Replacement crew will appear in their place.

### **BOMBER NOSE SCREEN**

Your Bomber will be decorated with painted markings as a record of any combat/bombing success: bombs for completed missions and crosses for enemy fighters shot down.

### **SAVE GAME/BOMBER/PILOT/CREW**

Note that you *cannot* Save the game in the middle of a mission. Once you finish a mission an Icon will appear to allow you to Save a particular campaign in the Roster Screen. Follow any on-screen prompts. For more details please consult the *Technical Supplement* in your *Flying Fortress* package. You can continue the current campaign once you start the simulation or choose to start a new campaign.

### **END OF TOUR**

If you succeed in completing 25 missions that will be the end of your tour of duty. Your battle-hardened crew will be sent back home for a well earned rest and employment as training instructors. If you wish to return to combat duty choose another bomber and crew and start again. There are enough targets in *Flying Fortress* to keep you flying for a very long time.







# A Battleship for the Skies





## A BATTLESHIP FOR THE SKIES

When newspaper reporters were first shown Model 299 in Boeing's Seattle factory on 16th July 1935, the aircraft simply took their breath away.

"A regular fortress", one of them said, "a fortress with wings!"

The company liked the name used in the headlines, so decided to register it as a trade mark. "The Flying Fortress" was born.

Commissioned by the US Army Air Corps (USAAC), her specifications were those of a 'battleship of the skies'; a multi-engined bomber capable of 200 to 250 mph at 10,000 feet with a cruising speed of 170 to 200 mph, a range of 6 to 10 hours and a service ceiling of 25,000 feet.

When thirteen Model 299's were received by the USAAC, they were designated YB-17's. Y stood for evaluation, B for bomber, 17 for the 17th bomber design USAAC had accepted; it was an aircraft which exceeded all their specifications for speed, range, climb and load carrying performance.

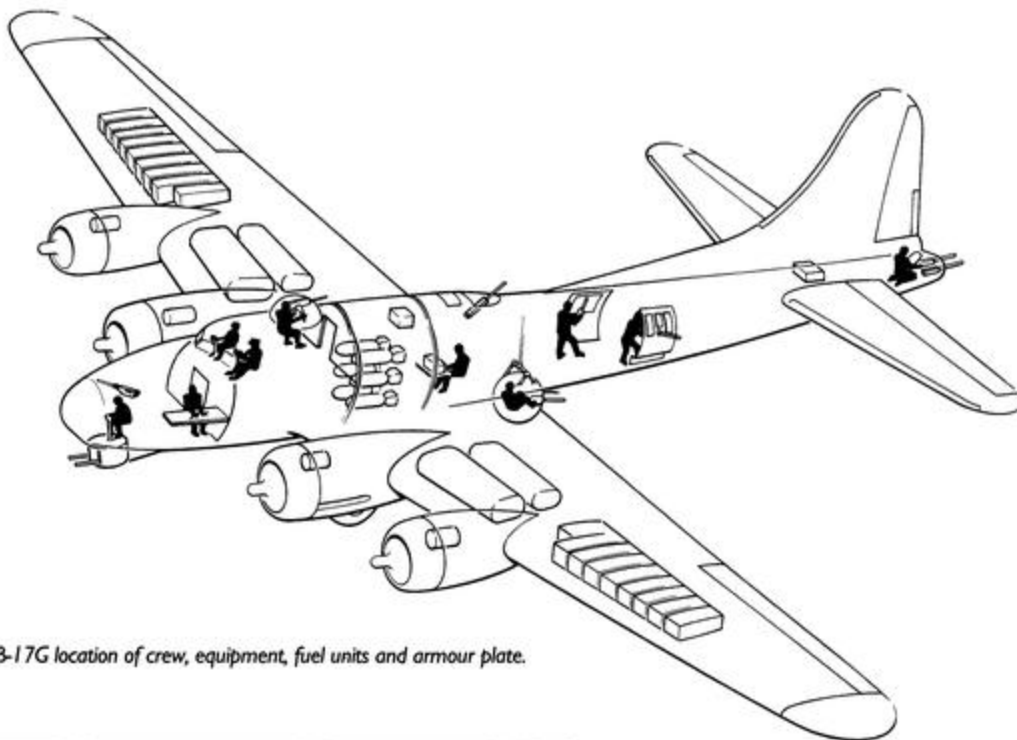

*B-17G location of crew, equipment, fuel units and armour plate.*





President Roosevelt's realisation that involvement in a war in Europe could not be avoided, combined with the bomber's good press, ensured that it was not long before the first orders were placed with Boeing for the production of the turbo-equipped B-17B's. Luckily, the B-17 had one more feature: its adaptability to further development. Thirty-nine B-17B's were delivered to USAAC when the war broke out in Europe in 1939, followed by thirty-eight B-17C's and forty-two B-17D's; new improved designs that could give 323 mph



*The Seattle-built B-17F "Knockout Dropper" after returning from a bombing mission on Norway and setting a then US record of 50 operational flights.*

The B-17F rolled off the production line in the summer of 1942 and Boeing were eventually to build 3,405 of them. The B-17F was to be the model that flew the US 8th Air Force daylight unescorted raids into Europe in 1943.

The next model, the B-17G was the final development of the design. 8,680 B-17G's were built. In total, Boeing managed to equip 108 squadrons of the 8th Air Force, 20 squadrons of the 15th Air Force in Italy and provided 200 B-17's to be used by the RAF.

top speed at 25,000 feet. In 1941, the RAF were sent twenty B-17C's and Bomber Command designated them Fortress 1's.

Boeing eventually took note of any design faults in the early types and produced, what was in effect, a completely new bomber, the B-17E, with its distinctive large tail fin and much improved firepower. The company built 512 B-17E's and then progressed to the B-17F which was the first truly battle-ready Flying Fortress.



Inspecting cannon fire damage inflicted by German jet-powered fighter planes. Wing control surfaces were damaged but the fuel tanks remained intact as the pilot brought the B-17 back from the raid on Hamburg.

Most of the men who had flown a B-17 knew that it was a rugged plane,

“She’ll fight her way through to the target, do the job, take anything thrown at her and then do her damndest to get you home,” stated a B-17 pilot inspecting a large hole in his plane’s fuselage after a successful mission.

27th November 1942

### Controls Shot Away, Fort Crew Still Slams Nazis and Gets Home

A 20 year-old Flying Fortress pilot who forced his bullet-ridden ship to carry him and his wounded crew home after a successful attack hobbled into dinner on a wounded foot after a dangerous landing. Fellow flyers asked him how he could fly the bomber with a bullet in his foot.

“It was nothing much,” he said, “I didn’t have any control surfaces left to use the foot on anyway.”

It was the second time in three weeks that the same fort with the same crew had successfully fought off a Nazi plane attack and returned home safely.

It was calculated that the average life of a B-17 flown by the US 8th Air Force was 215 days: for 119 days the aircraft was non-operational, it was under repair for 49 days and flying missions for 47 days.

Such was the fury of aerial combat in the European theatre of operations that *it was notable if a B-17 survived 25 missions in its first year.*





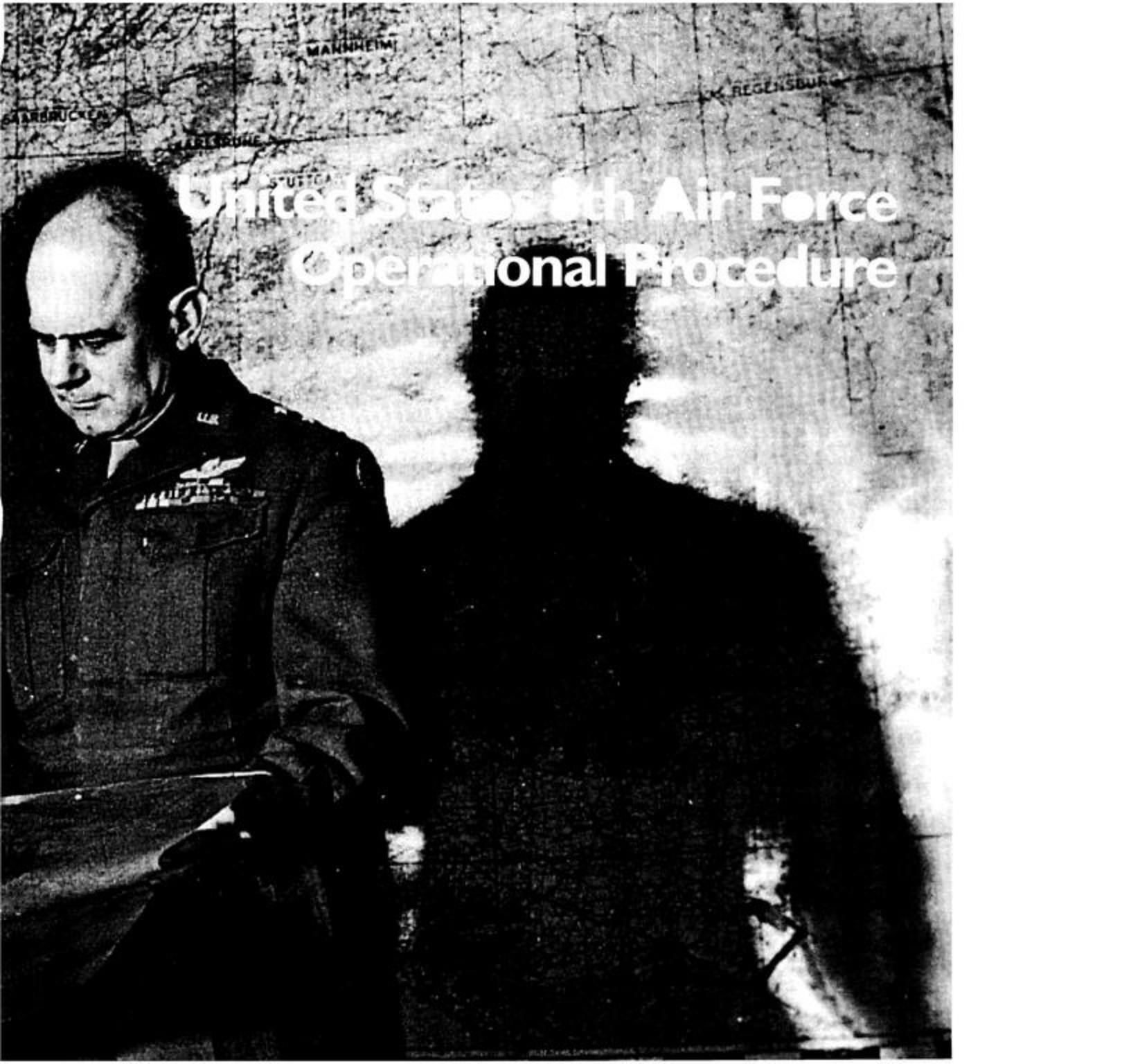

# United States 8th Air Force Operational Procedure

SAARBRÜCKEN

MANNHEIM

KARLSRUHE

STUTTGART





# UNITED STATES 8TH AIR FORCE OPERATIONAL PROCEDURE

THE American 8th Air Force had 983 operational days during World War Two in which its primary mission remained the same: daylight, high altitude precision bombing of occupied Europe with large formations of bombers.

## VIII BOMBER COMMAND

All standard daily operations were initiated by the US VIII Bomber Command with reference to the Combined Bomber Offensive Directive. The main restricting factor to every operation was the weather. A weather briefing took place every day at 10.15, 16.00, and 22.00 at the HQ of the US Strategic Air Force in Europe in High Wycombe, about 20 miles

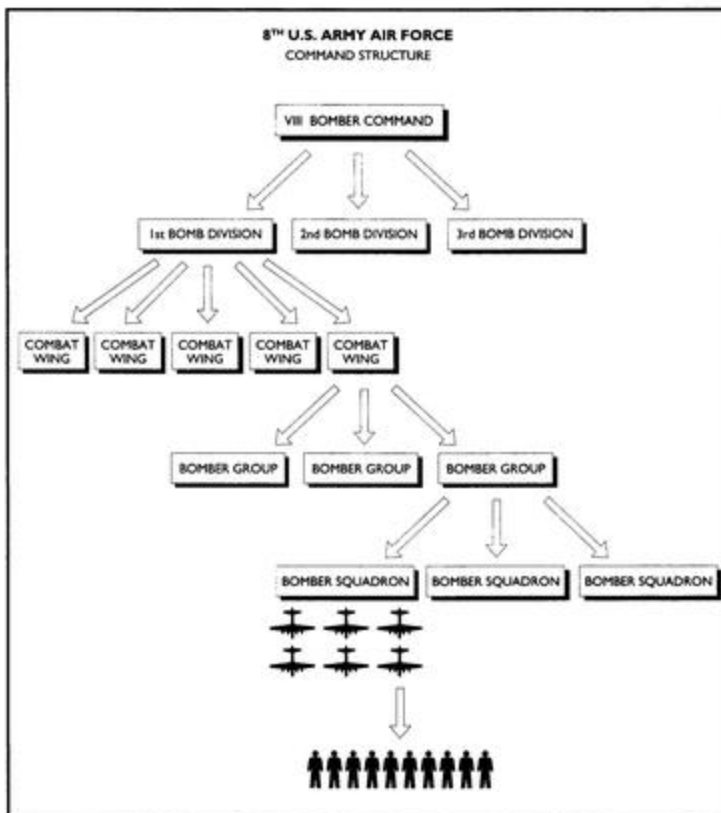

west of London. Here senior operations officers received forecasts for the specified targets and for bases from where the aircraft took off. If the weather outlook was bad for the next day, the missions would be stopped after the 16.00 meeting. If the weather forecast was good, the Deputy Commander of Operations was informed and his staff selected target from the priority list. The weather played a major part in the scale of the operation; stable high pressure and clear skies were





the ideal conditions for large formations of bombers and demanded a top priority target. If there was a chance of cloud the bomber force could be assigned several lower priority targets.

After further consultation with the experts, the Chief of Operations at High Wycombe HQ would make the final decision to go and confirm it at an operational conference held at 22.00 hours. Targets, the force required and a co-ordinated plan of operations were worked out and written down in a formal Field Order which directed the bomber force into action. The HQs lower down in the chain of command were then informed.



*Armourers each carrying one 0.50 calibre machine gun and a belt of ammo prepare a P-51 Mustang for an escort mission.*

## BOMB DIVISIONS

When the three Bomb Divisions received details of the target and ordnance required a specific plan was worked out. Specialists studied target identification details and the Mean Point of Impact (MPI) for bomb strikes was established, along with the type of bomb and the tonnage required. Route times and mean altitude were calculated and Fighter Command consulted about fighter escort requirements. The information was then passed to the Combat Wings.





The US 8th Air Force Bases in England.



- 1 Alconbury B-17
- 2 Attlebridge B-24
- 3 Bassingbourn B-17
- 4 Bodney P-47
- 5 Bottisham P-47
- 6 Bovingdon B-17
- 7 Boxted P-47
- 8 Bungay B-24
- 9 Bury St Edmunds B-17
- 10 Cheddington B-24
- 11 Chelveston B-17
- 12 Debach B-24
- 13 Debden P-51
- 14 Deenethorpe B-17
- 15 Deopham Green B-17

- 16 Duxford P-47
- 17 East Wretham P-47
- 18 Eye B-24
- 19 Fowlmere P-51
- 20 Framlingham B-17
- 21 Glatton B-17
- 22 Grafton Underwood B-17
- 23 Great Ashfield B-17
- 24 Halesworth B-24
- 25 Hardwick B-24
- 26 Hethel B-24
- 27 Honington P-38
- 28 Horham B-17
- 29 Horsham St Faith B-24
- 30 Kimbolton B-17

- 31 Kings Cliffe P-38
- 32 Knettishall B-17
- 33 Lavenham B-24
- 34 Leiston P-51
- 35 Martlesham Heath P-47
- 36 Metfield B-24
- 37 Molesworth B-17
- 38 North Pickenham B-24
- 39 Nuthampstead B-17
- 40 Old Buckenham B-24
- 41 Podington B-17
- 42 Polebrook B-17
- 43 Rackheath B-24
- 44 Rattlesden B-17
- 45 Raydon P-47

- 46 Ridgewell B-17
- 47 Seething B-24
- 48 Shipdam B-24
- 49 Snetterton Heath B-17
- 50 Steeple Morden P-51
- 51 Sudbury B-24
- 52 Thorpe Abbots B-17
- 53 Thurleigh B-17
- 54 Tibenham B-24
- 55 Wattisham P-38
- 56 Wendling B-24
- 57 Wormingford P-38



## THE COMBAT WINGS

The 14 Combat Wing HQ's concentrated on purely operational matters and produced co-ordinated plans for each of their individual Bomber Groups to cover all parts of the bombing mission and to control the course of the mission.

## THE BOMBING GROUPS

The Bombing Group was the main combat unit and usually received its first warning of the mission by telephone from the Groups Operational Centre. The Group Watch Officer, based in the Group Ops building, a windowless and gas proof structure, then told the duty clerk to inform all the necessary services on the base. These were:

**The Group Commanding Officer**

**S-3 Group Ops Officer**

**S-2 Intelligence Section**

**Group Navigator and Bombardier Officers**

**The Weather Office**

**The Flying Control**

**Ordnance and Armaments Section**

**The Engineering Officer**

**The Signals/Photographic Units**

**The Mess Hall**

**Transportation**

The duty clerk also informed the guard room MP's to limit movements in and out of the camp and the telephone exchange to restrict calls. A red flag was then raised to inform camp personnel that they were restricted to barracks.



*"Pistol Packin' Mama" is readied during the night for a dawn take off. Bombs are loaded, guns and engines checked. The ground crew chief is on the ladder (left).*



Information sent by Wing, in advance of the Field Order, gave the number of aircraft to be prepared and the bomb and fuel loads. An availability list of crew and aircraft was prepared. The practice was that one squadron would stand down every fourth mission and the lead crew would be assigned on a set rota. The target code was deciphered by S-2 Intelligence officers and the correct folder retrieved from a high security safe. The folder contained a clear vertical photograph and other specific details of the target. A grid was placed over the photo and the required MPI (the centre of the desired bomb pattern) established and then target information was distributed. In the Intelligence building, the staff assembled photos, flak location charts and maps while, in the Group navigator's office, others were marking out the planned routes, distances and times of assembly. Schedules



*The US 8th Air Force operational room. Their job was to plot all aircraft activities during raids into Europe by their bombers.*

were calculated so that everything could coincide with the designated zero hour. Ordnance were then informed of the bomb load and ground crews put in readiness.

Everything was ready for the mission briefing where the crews assembled and the target for that day announced. The chain of command ended with the individual flyers who had to take the B-17's across occupied Europe. It was their job to complete the planned mission.





# A B-17 Bombing Mission





# A B-17 BOMBING MISSION

## GROUND CREW

### The Chief Engineer

**4**am. The noise of trucks on the move can be heard across the base, Ordnance crews are collecting bombs from the dump. The Chief and his ground crew are



*Ground crew giving a complete and careful overhaul to a B-17F after a non-combat flight. On the ground below the nose is the portable generator known as the 'putt-putt'.*

already awake and at work on the aircraft. The auxiliary power plant, a small petrol generator called the 'putt-putt', is started up. It is there to boost the electrical supply of the plane on the ground and save the aircraft batteries.

### The Armaments Officer

The Squadron Armaments officer appears and climbs into the B-17. He opens the door to the bomb bay, walks along the catwalk and sits in the bomb aimer's seat in the nose. He switches on the bombardier's panel and opens the bomb bay doors by moving the first of two levers. He checks that the red warning light has come on. He then moves the second lever to one of 3 positions. He chooses 'Selective' (a selective drop of bombs). He switches on the Intervalometer which sets the bomb drop intervals and then tests the bomb shackles and electric firing solenoids by pressing the bomb release located on the top of the panel. Test lights flash back at him as he switches the lever to 'Salvo' (emergency drop of bombs) and 'Lock'.





The Chief checks the operation of the bomb bay doors from the outside, then removes the canvas windshield cover. The Duty Mechanic removes the canvas wraps from the engine cowling.

## The Bombs

It's not long before the ordnance crew arrive with the bomb loads. The service truck is pushed under the plane and located below the bomb bay. The trailer contains ten M-43 500lb general purpose bombs. They are all marked with two yellow bands front and back; the indication that they contain TNT. The



*Bomb service truck and trailer approach a flight of B-17's with 2 one-ton bombs. Exploding fragments from these bombs could travel over a mile in distance.*

ordnance crew attach the shackles from the B-17's racks to two lugs on each bomb. The bombs are then winched into the bay and placed at the correct station. The tail fins are screwed on and the nose and tail fuses carefully fitted into the bomb. Each fuse has a small propeller-like vane which rotates as the bomb drops and arms the fuse. The device is made safe by a securing wire that will be removed by a member of the crew after the bomber has taken off.

## The Pre-Flight

Meanwhile, the ground crew are pre-flighting the B-17. The prop blades are pulled and turned through three complete revolutions, to remove any excess fuel which may have seeped down overnight. The Chief performs his checks. He turns on the battery and ignition switches and ensures that the terminals on the voltage converters are not shorting. The fuel booster pump is turned on, the pressure checked and the throttle set to 1000 rpm. He starts number one engine, then the other three. The turbo supercharging system, that enables the 1,200hp engines to run at full power between 20,000 and 30,000 feet, is inspected and the prop pitch controls are checked. Then everything reported faulty from the previous day's mission is checked again.



## The Ammunition

At the same time an ammunition truck appears and unloads 10 wooden boxes of 0.50 calibre ammo into the rear fuselage door. The 0.50 calibre machine guns are loaded onto the plane and installed. Each weighs 64lbs and is capable of firing 750 rounds per minute at a maximum range of 3,500 feet. Each magazine contains 365 rounds.

## The Fuel, Tyres and Oxygen

The fuel tanks are then topped up. The B-17G has a maximum capacity of 2,780 US gallons with 5 filling points on each wing between the two engines. The tanks are self-sealing Tokyo Tanks made up of a rubber composite divided up into 18 small cells. The tyres are inspected and any small oil leaks from the engines are checked for signs of deterioration. The oxygen supplies are checked. These consist of 18 light metal bottles each giving 5 hours supply to one man at 30,000 feet.

## FLIGHT CREW

### The Crew

The flight crew arrive as the last major checks are being completed. They are clutching their flight bags and parachute packs, wearing olive coveralls, heavy brown sheepskin jackets and trousers. A standard crew for a B-17G, by rank and position, was:

1st Lieutenant- Pilot/Captain

Flight Officer- Co-Pilot

Staff Sergeant- Right Waist Gunner

Staff Sergeant- Ball Turret Gunner

2nd Lieutenant- Bombardier/Toggler (toggles bombs on visual sighting of other dropped bombs).



*Two crew members inspect their brand new flak vests; steel strips covered in canvas designed to protect them from slivers of exploding flak shell.*



2nd Lieutenant- Navigator

Technical Sergeant- Radio Operator

Technical Sergeant- Engineer/Top Turret Gunner

Staff Sergeant- Left Waist Gunner

Staff Sergeant- Tail Gunner

## Pre-take off Procedure

The crew perform their own checks and they confirm over their throat microphones that they are all in position. The engines are started up and the altimeter is set for the height of the airdrome above sea level. The chocks are signalled away. The B-17 taxis off and joins the other bombers in a set pattern at the edge of the runway. The pilot has to keep the 30 tons of plane on the tarmac whilst not being able to see ahead. He steers by watching the edge of the tarmac paths through a side window of the cockpit and tries to use the brakes as little as possible. He knows that over use in taxiing can burn out the brake linings. The engines are revved to 1,500 rpm to clear out any muck from the spark plugs and all the while the tail gunner keeps an eye on the plane behind; in case it gets closer than the standard 30 yards.

9th October 1942

## Single Fort Fights Off 50 Nazi Planes

This is a story of heroism - the heroism of men and their machine. The machine was a Flying Fortress, the men were the crew.

"They were two miles above France, two engines were out of commission. In the plane were three shell holes in the rudder and three more in the stabilizer and another in the wing, half the controls were shot away, the landing gear was smashed and there were more than 200 holes in the fuselage."

That was the result of anti-aircraft fire.

Then they were attacked by 50 Focke-Wulf 190's.

The crew members weren't professional soldiers with lots of experience. All were fresh from civilian life. The pilot and co-pilot were lawyers, the bombardier was a student. The navigator worked for a polling organization. A coal miner,

a painter and a printer manned the guns.

And this crew, which hadn't even flown together as a complete unit before, brought their plane safely back to England.

Their B-17 was the last bomber over the target. They had just crossed the target when Lieutenant Price heard shouts from every corner of the plane.

"Here they come!"

"They" were Focke-Wulf 190's.

From every side they came, spitting machine gun bullets and cannon shells from every angle. Every gun in the Fortress burst in staccato reply. Cannon shells knocked one of the engines out and the B-17 started to lose her place in the formation. The Fw 190's swooped in for the kill. The pilot started a long glide down as anti-aircraft shells ripped a big hole in the wing and three more shells tore a big chunk out of the rudder.....



*Captain Bridges and Captain Shannon pilot and co-pilot who had flown 50 and 36 missions respectively in the bomber "Mild and Bitter" which had itself completed, a then record of, 82 missions.*

and white chequered runway control van. The controller looks through the glass roof of the van and signals with an Aldis lamp. He tries to time each take off at one minute intervals. The Captain takes the pressure off the foot brake and selects the correct manifold pressure and opens the throttles. At 100mph, the B-17 takes off and the pilot eases up on the control column and raises the landing gear. This is an anxious time for most crew as the plane, packed full of bombs and fuel, climbs gradually and builds up speed. At the IAS (Indicated Air Speed) of 150mph the Captain throttles back and reduces the rpm from 2,500 to 2,300 by adjusting the propeller pitch controls. The plane should now be climbing at about 300 feet per minute and flying through any overcast, to assemble in formation above the clouds. This is the time when there is the greatest risk of collision with another aircraft in the Group.

When the aircraft gets to the edge of the mile and a quarter long runway it waits with other members of its squadron and then a 'take off check' is performed: aileron, elevators and rudder trim tab controls are zeroed. The wing flaps raised and the propeller pitch control tested. The generators are turned on, the turbo-superchargers tested, the parking brake and the tail wheel lock turned off.

## The Take Off

The Captain swings the aircraft into position just after the plane in front begins to take off on the 150 foot wide runway. He locks the tail wheel to 'on' to keep the B-17 straight during its run. Final checks are made to gyros, generators and fuel booster pumps as the Captain waits for the double-flash of green light



*B-17 Master Sgt. checks the altimeter in the nose of the aircraft with that of the pilot. His right hand holds down a switch so that he can talk to the pilot using his throat microphone.*



*Officers in the control tower of an US 8th Air Force Bomber Command in the tense final seconds before the dawn of another raid.*

## Assembling in Formation

The Captain's next task is to assemble in formation with other planes of the squadron, as stipulated by orders. A radio compass is used that works with short range radio beacons in selected locations. A morse call sign (called a Buncher signal) is transmitted and the plane receives it via a small loop aerial located under the nose section. Lead aircraft fire different coloured flares at 10,000 feet to give a

visual check for other pilots. Squadrons have to be built into Groups, Groups into Wings and Combat Wings into Divisional Columns. The whole process is very slow because everyone has to keep up with everyone else. Above 10,000 feet the crew are told to go to oxygen. The heating should already be operational. The two waist gunners have electrically heated flying suits under their sheepskins but the rest of the crew have warm air ducts that channel heat to their sections. The ball turret gunner is the last to get into position. The turret is very cramped and always assigned to someone who is of small build. He has to spend about 5 hours curled up, looking 5 miles below him, without the comfort of a parachute. If something

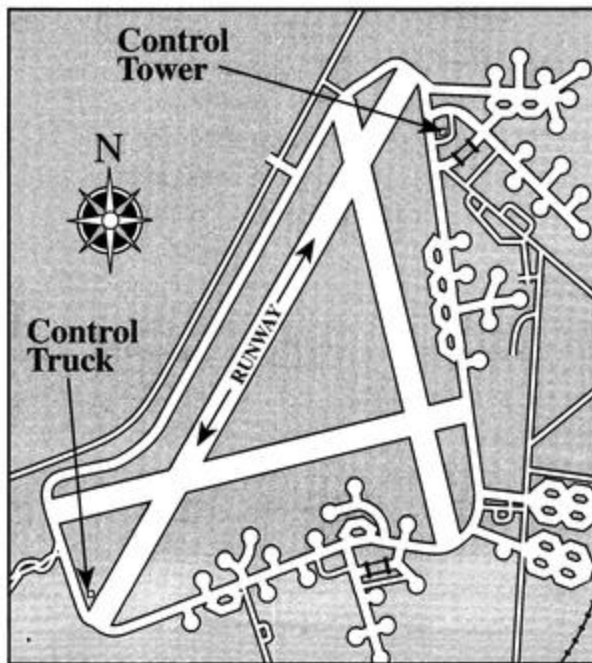

*A typical 8th Air Force airfield layout with squadron dispersal points.*

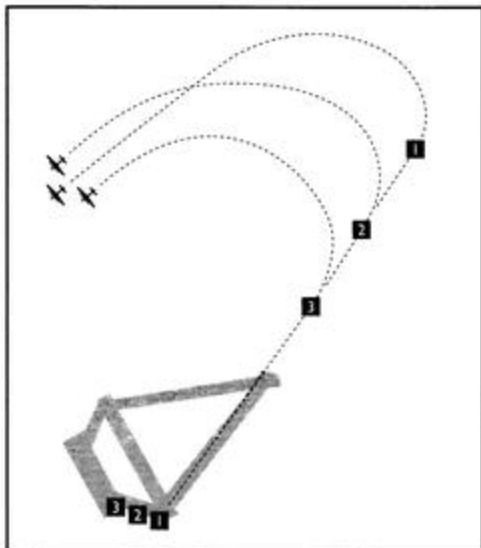

*Taking off in Vee formation. The aircraft took off at one minute intervals turning at the marked points to achieve correct formation at 1000 feet.*

humidity producing condensation trails. The formation levels off at 21,000 feet. The Navigator, even though they are travelling in formation, keeps an accurate track of their position using his "GEE" box. The guns are loaded and test fired about 30 miles off the English coast, at the same time the arming pins are removed from the 10 bombs in the bay. The Captain looks at the Airspeed Indicator which registers 150mph but knows this is not the true airspeed (about 206mph). Working on atmospheric pressure the AI reading declines with increased altitude.

happened to the B-17 it would take him, with help, about a minute to get out and get his parachute on; a minute in a crashing B-17 is an extremely long time.

## High Altitude Flight

At 13,000 feet, the aircraft climbs at 200 feet per minute. Above 19,000 feet, the ball turret gunner reports contrails; gases from the hot engine exhaust meeting the frozen air in areas of high

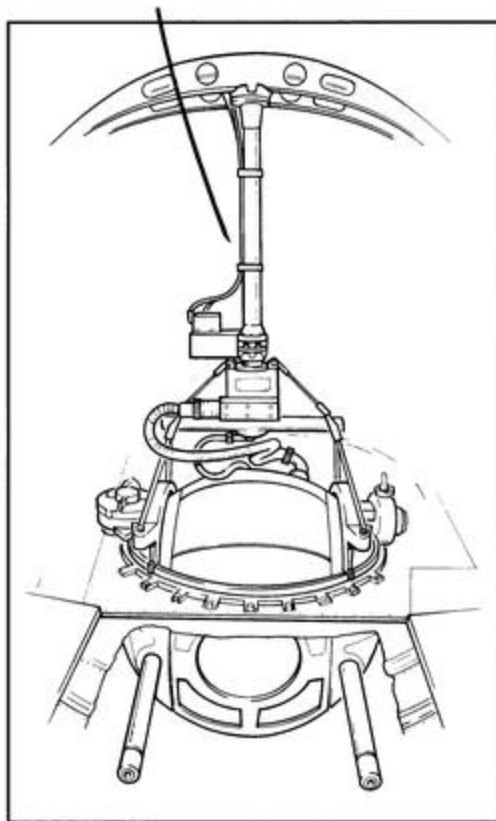

*The Sperry ball turret was one of the most effective defensive gun positions on the B-17 but the least favourite among crews. It required a gunner of small stature who was not prone to claustrophobia. In event of a crash belly landing, the ball turret could be released from its housing and dropped.*





## Into Enemy Territory

Over the enemy coast the crew don their cumbersome flak suits, worn like body armour made of overlapping thin steel plates inside canvas aprons. They know the German radar and listening posts will have been tracking them for the last hour and the enemy defence controllers will be trying to guess their mission objectives. The gunners in the B-17 look all around their field of fire re-assured by the sight of the zig-zagging 'Little Friends' 6,000 feet above them; P-47's fitted with long distance drop tanks. Then the flak begins to burst in little black clouds around the formation.

## The Initial Point

The formation reaches the Initial Point: the selected point over which the bomber force will begin its turn to make the bomb run on the target.

Flares are fired to give visual confirmation. In this case, the cloud cover (undercast) is too thick, and the leading aircraft from the Pathfinder Force will mark the target



*P-51 Mustangs streak across the skies escorting B-17's heading for targets in northern Germany.*

30th August 1943

### Gunner Hangs by Toes From Fort Ball Turret

Hanging by his feet from the ball turret of a Fortress 2 miles up in the air gave S/Sgt. Abe Klavel a lop-sided view of Nazi fighters.

Klavel fell from his turret when the door came off but as luck would have it, his toes hooked over the range pedal of one of the turret guns. He dangled there without a parachute as enemy fighters swept through the formation, until he could haul himself up by his toes.

using their H2X ground-scanning radar sets. The leading Combat Wing approaches the bombing run. There are four minute intervals between Wings. Flak intensifies and squadrons of enemy fighters sweep through the formations firing at 'Purple Heart Corner': the lowest, rear most and therefore most exposed flight in the formation.



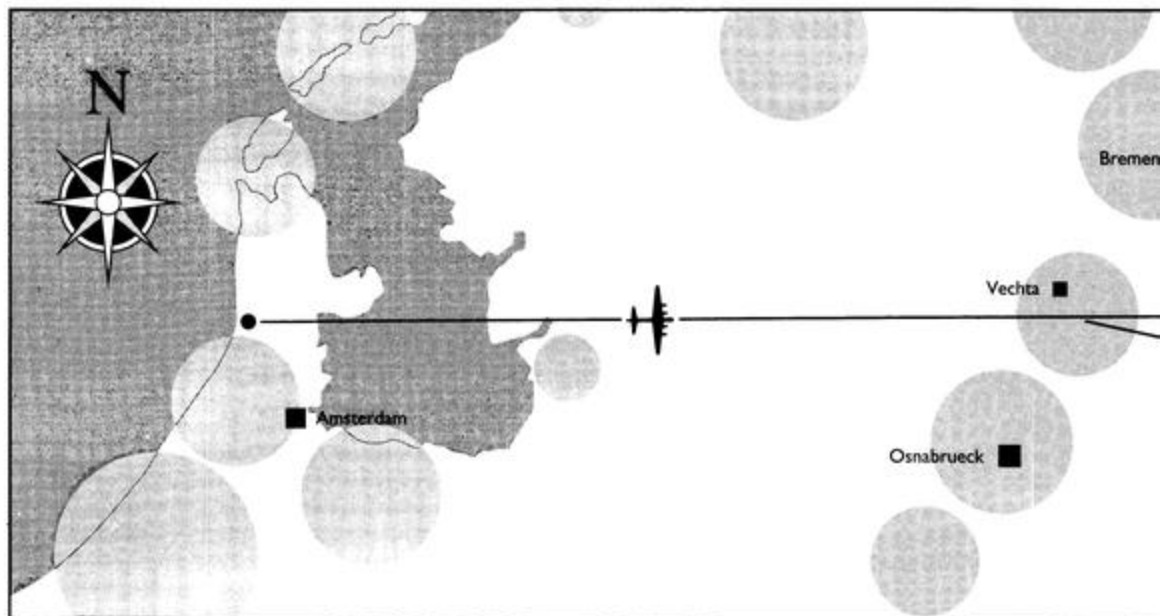

A typical route for a B-17 attack on targets around Berlin with marked Flak concentrations centred around likely targets. The 900 bombers flew in combat boxes that stretched for 100 miles and took 30 minutes to pass a given point. In this case there were 3 targets so the attacking force was split into three with a bomb run flown into the prevailing wind.

## The Bomb Run

The Bombardier opens the bomb doors and flips open the safety lever on the bomb release. In this mission he does not have a bomb sight and is waiting for the leader to drop his bombs. When the lead bombardier is lined up on the smoke markers released by the Pathfinders, a red flare is fired and the bombs are released. The Group hope to bomb a compact area 500 by 250 yards. The ball turret gunner confirms that the bombs have been released and the bomb bay is checked to see that

21st November 1942

### Bomber Crew Get Four Fw's in 30 Minutes

A half-hour of hell in a B-17 whose tail gunner kept on shooting with his whole side mangled; a cannon hole through the aircraft fuselage; a waist gunner still firing; a motor and a wing smashed, but all safe home. Four German fighters down for sure, four more probable and they fought off 30.

That's the story of a bomber crew's heroism in a noontime's work over Rouen.

The tail gunner's whole left side was sprayed with steel fragments. But for the next fifteen minutes he fired his remaining gun with one hand and, when a Fw 190 came too close he calmly shot it down in flames.

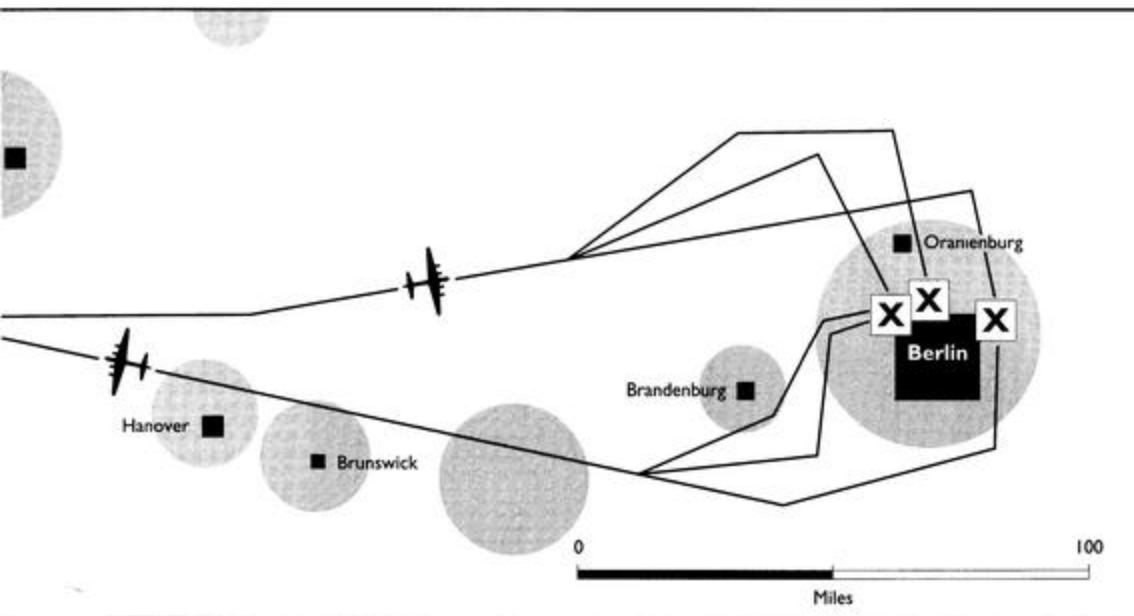

all bombs have gone and then the doors are closed. With the loss of the weight of the bombs the formation speeds up to about 160 IAS (224mph) and heads for the designated rally point.



*A bombardier looks out of the plexiglass nose section on the lead plane of a B-17G flight about to take off for a raid over enemy territory. In front of him is the famous Norden Bombsight and the levers for operating the chin-turret.*

## The Rally Point

The rally point is chosen as a known area out of range of enemy flak batteries where the squadrons can re-form into defensive combat wing formations. The combat wing leader tells the radio operator to send a 'target bombed' message to HQ.

100 miles from home, IFF (a signal Identification Friend or Foe) is switched on by the radio operator to warn friendly bases of the force passing above them. During the mission the B-17 could identify itself to friendly aircraft by firing coloured flares on a pre-set code or by flashing the correct mission code with an Aldis lamp. The plane now drops 500 feet per minute



and, once below 10,000 feet, the crew come off oxygen. Home base is informed of their arrival times and all activity is based on their ETA.

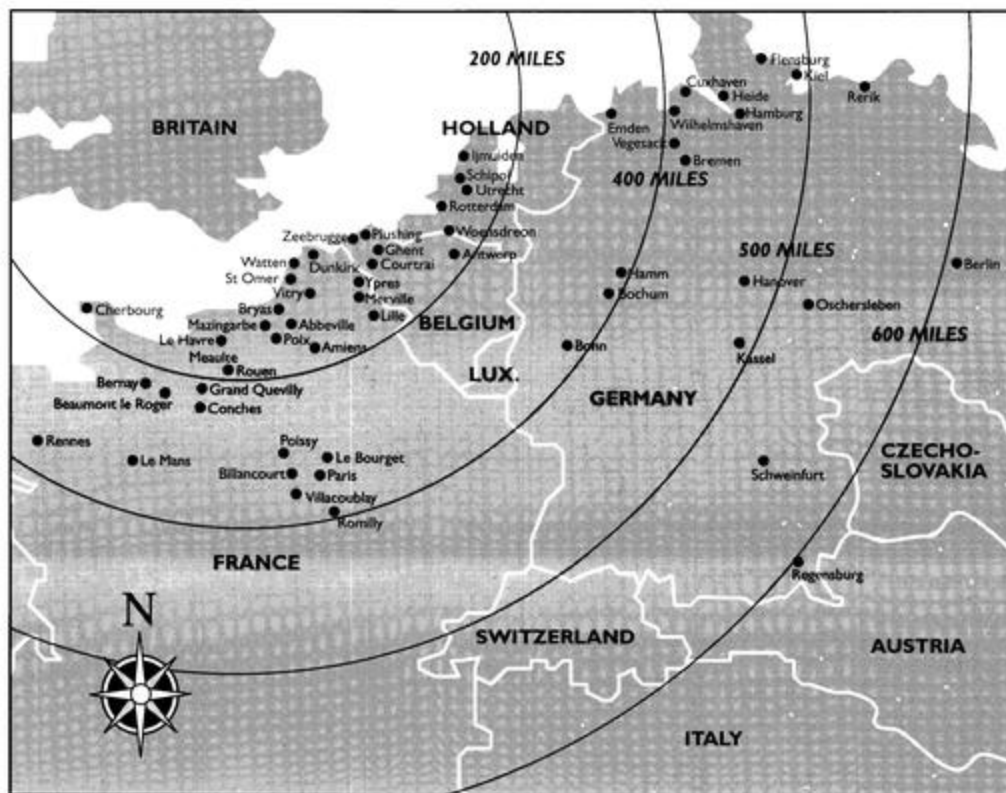

*A selection of US 8th Air Force targets in occupied Europe and the distances the force had to travel to get there. Targets deep in central Germany were extremely hazardous without the long-range escort fighter support. In the last few months of the war, with almost complete air superiority, missions to Berlin were commonplace.*

## The Return to Base

Flying control picks up radio signals from the formation approaching the base. The Ops officer is already waiting at the tower. The duty clerk informs the MP's, ambulance and fire tender crews. By the time the planes are over the airfield they have spaced themselves out giving priority to those with casualties and damage. After these bombers have landed the order of landing is the lowest altitude squadrons first. Bombers land at about 20 second intervals, planes with casualties turn off the runway as soon as possible to be intercepted by awaiting ambulances.



Ground crews and base officers wait for the returning heavy bomber formation to appear.

Other bombers use the two outside engines to taxi directly to their airfield dispersal point. The flight crew get out, stretch their legs, inspect their aircraft and pack their flight bags. The gunners remove the guns and clean them ready to be collected by the ammunition crews. The pilot fills in Form 1A to report any flight problems and damage sustained on the mission.

## De-Briefing

A truck arrives to collect the flight crew and take them directly to the briefing rooms. Here, personal equipment is handed in (parachutes, flying suits, oxygen masks, Mae Wests etc.) and the crew get something to eat. An Ops officer lists any items of important news that has to be



A red flare is fired from a returning Flying Fortress warning the ambulance crews gathered below that there are wounded aboard the aircraft.

20th January 1943

### Fortress Dives 7,000 Feet as Pilot Fights for Control

Controls gyrating so wildly that the pilot and co-pilot were hauled from their seats, the Flying Fortress plunged toward the English Channel.

Struck simultaneously on both wings by cannon fire from Me 109's, the ship, which had just completed its bombing run over Lorient in a recent raid twisted out of control and went into a dive.

As the crew and anything movable were being thrown about the

interior the Flying Fortress fell from 10,000 feet followed by Me 109's pumping bullets into the plane.

At 3000 feet Capt. E. Wrightson fought with the controls and pulled the bomber out of its death dive.

Intelligence officers heard the story when they interrogated the crew. The plane was part of a formation attacking a U-boat harbour.

acted upon immediately; such as aircraft in trouble, planes ditching in the sea and important enemy activity. When all is ready, the crews are interrogated; one interrogating officer per crew. The officer asks a standard set of questions encompassing all aspects of the mission, such as enemy fighter numbers, flak locations, weather over the target, fighter escort, lost aircraft and any other observations. Claims by gunners for the number and type of aircraft shot down are then reviewed and compared in order to



5 BW C-2. 6(10-9-43)

**COMBAT REPORT**

CONFIDENTIAL

GROUP 303 SQN 526 A/C 0353 DATE 13/1/44

## WHERE ATTACK

TOOK PLACE 4785N-0834E HEIGHT 24,000' TIME 1450Our Heading 95°Type of E/A ME 109Clock Pos 0530Attack Level LOW

## MARK A/C ATTACKED AND CLOCK POSITION

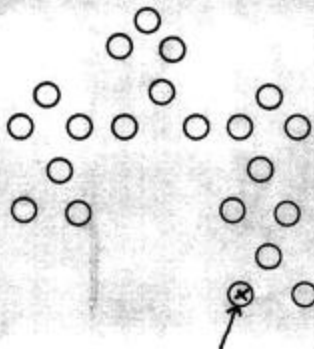
DO NOT  
WRITE IN  
THIS SPACE

## COMPLETE STORY OF THE ATTACK

ENEMY AIRCRAFT ATTACK FROM 1600 YARDS - CAME IN LOW.  
 TAIL GUNNER STARTED FIRING FROM 750 YARDS (80 ROUNDS FIRED)  
 BALL TURRET GUNNER FIRED (50 ROUNDS) AS E/A PASSED UNDER B-T  
 Gunner responsible for E/A damage 1/SGT. J. KOWALSKI Position BALL TURRET  
 Other gun positions firing on the same E/A TAIL GUN  
 Other A/C firing at the same time at the same E/A; A/C Nos. NONE  
 If E/A was shot down or damaged: Corroborated by: \_\_\_\_\_

S/SGT. DANWHE A/C No. 0353 Position in A/C L.W.C.LT. SHARPE A/C No. 0353 Position in A/C BAR.T/SGT. BURNES A/C No. 0353 Position in A/C TGComments of interrogator: E/A SEEN TO SHOCK AND DIVE. PILOT  
OBSERVED TO BAIL OUT. CONFIRMED BY A/C 0274Interrogator [Signature] Time 17.50

If information varied widely from standard, show by diagram on back of this sheet.  
 In reproducing this form, no changes will be made.

CONFIDENTIAL



*Crewmen after a bombing mission congratulate their gunner who shot down three enemy fighters.*

avoid 'doubling-up'. Navigators hand in their flight logs and, with bombardiers, write up their own specific reports. Lead bomber crews are interrogated further with more detailed questions. The whole process takes upwards of one hour forty-five minutes.

When the crews are dismissed, trucks take them to the mess hall or back to their barracks. Most will want to sleep, shattered by the fatigue of combat. They know that they may be called upon to fly again in a few hours time.

## Target Assessment

Pictures taken from strike cameras are studied in Group Operations and Intelligence rooms as soon as they have been processed. The Group strike pattern on target is plotted and a detailed report sent to Wing and Division. An assessment of the results of the bombing is analysed at Division HQ and the loss to the enemy is calculated. If necessary, the target is put back on a priority list for future attack. Meanwhile, the ground crew is back at work on the planes. They have been sleeping for the duration of the mission, now they are back at work patching up the aircraft and maintaining each bomber; ready for another combat mission tomorrow morning.

24th November 1944

## Flying Fort Lands by Itself!

A B-17 with its inboard engines out of action and the propellers feathered made an almost perfect landing in a corn field in Belgium - but without its crew!

The aircraft came to a halt near an Allied air base. Help was quickly to hand but no one was found in or near the bomber. Belgian farmers who witnessed the entire episode were adamant that there was no one on board.

It is believed that the bomber landed under the control of the automatic pilot.



*A post raid reconnaissance photo of the attack on the Marienburg Focke-Wulf Fw 190 factory.*



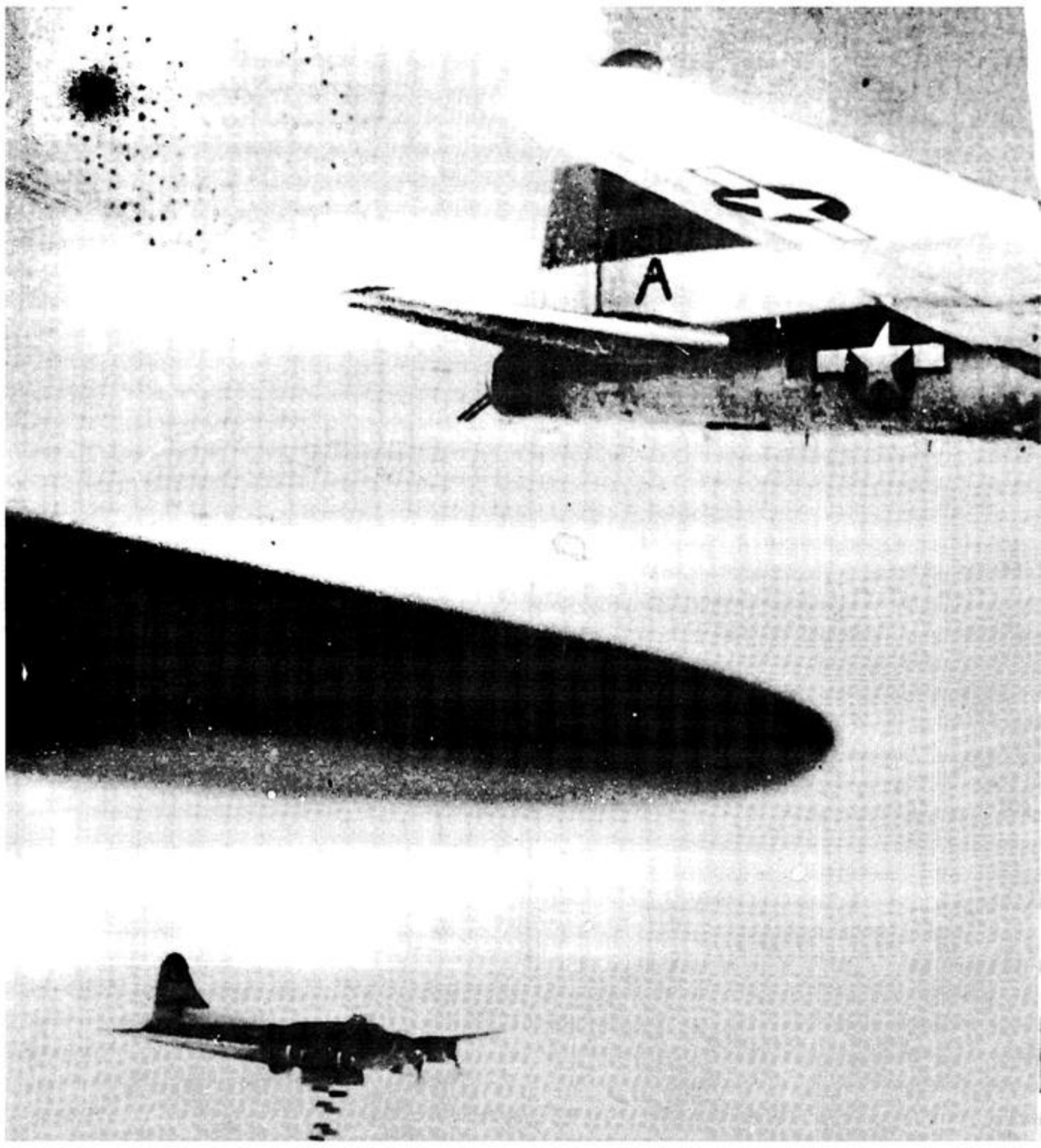



# Strategic Bombing

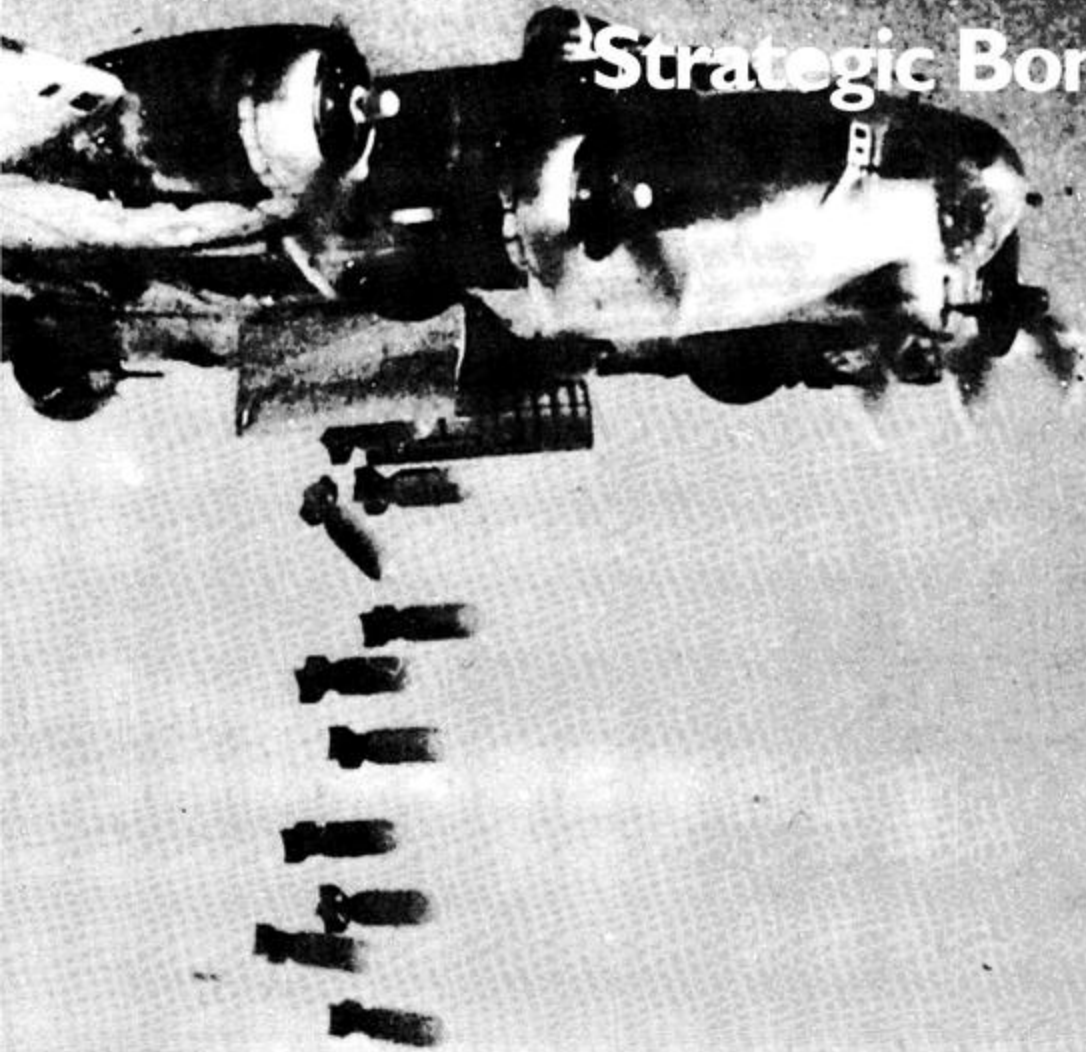



# STRATEGIC BOMBING

## THE CONCEPT OF WAR FROM THE AIR

In 1911, in his book "Command of the Air", the Italian Colonel Giulio Dauter prophesied that wars in the future would be waged using aircraft independent of ground forces to strike at civilian and industrial centres. This basic idea, later called *strategic bombing*, was adopted by many European military leaders and was to have a strong influence on tactical thinking about air power. Britain was committed to the concept of strategic bombing from the end of the First World War with the premise that a direct attack on the enemy's rear was the main role for an Air Force. In these early years, Sir Hugh Trenchard, regarded as the father of the RAF, completed a study of air power,

"There are two factors", he wrote, "moral and material effect. The object being to obtain the maximum of each. The best means (of doing this) is to attack industrial centres where you can do military and vital damage by striking at the centres of war materials and achieve the maximum effect on the morale of the population."

It was thought that strategic bombing extended the age-old principle of siege warfare: traditionally anyone who stayed within a fortress under siege would expect to suffer from the resultant hardships. After the experience of the First World War, the British and French governments tried to increase Air Force capabilities; the air force had to be given the means to mount an air offensive against a future enemy. At the same time, they tried to reduce the effects of enemy air raids.

"The bomber will always get through", stated Stanley Baldwin, the British Prime Minister and thus with this philosophy, RAF leaders pushed for the construction of a massive bomber force.

## GERMAN AIRCRAFT PRODUCTION

German aircraft production had developed on a smaller scale than Britain or the USA and was unsuitable for the production of large long-range machines that were needed to carry out strategic bombing. In the campaign that they waged against Britain in the early years of the war they had to use medium-range bombers which were originally designed to support ground troops. It was not until 1943 that the Luftwaffe tried to get a strategic bomber force built but, by then, it was too late. The



British and Americans had fine tuned their bombing tactics and could deliver 1000 bomber raids, day and night, deep into German territory. The Germans, with their diminishing resources, could never hope to catch up.

## THE 'BOMBING CODE'

Originally, both sides in the war believed that the bombing of targets such as ports, airfields, railways and bridges was legitimate behaviour and did not



*Three Junkers Ju. 88 A-4's in starboard echelon. The aircraft was used throughout the war period by the Luftwaffe for a variety of uses; including bomber in the Blitz on Britain.*

contravene the accepted conventions of war. There existed an unwritten code in the minds of Air Force leaders that prohibited the indiscriminate bombing of cities. When the Battle of Britain became a far more difficult struggle than was anticipated and Hitler ordered the bombing of London's East End, he still tried to justify breaking the code claiming that the

British had bombed German cities first. When the RAF bombed Berlin soon after in retaliation, Hitler announced that he "would raze the British cities to the ground".

## THE BRITISH BOMBING CAMPAIGN 1940-41

Although still not strong enough to cripple Germany, RAF Bomber Command began its campaign in the winter of 1940. The RAF bombed Munich, Germany in November and in retaliation the Luftwaffe carried out a raid on Coventry; destroying 60,000 buildings in the English industrial heartland. Bomber Command's response was an attack on Manheim which was unsuccessful, but was notable as the first recorded attempt at 'area bombing' by the RAF. Area Bombing was the destruction of a large industrial area without reference to precision targets. The winter of 1940-41 saw the burning of London and other cities by the Luftwaffe. There was no equivalent damage inflicted by the RAF on the German



cities. In fact, in some raids, more British aircrew died than German civilians mainly due to the poor design of the bombing aircraft.

## **THE BRITISH BOMBER PERFORMANCE 1940-41**

The British heavy bombers lacked speed, range, altitude and were severely under-powered. In most missions the RAF had to cross most of France, Belgium or Holland, all well defended by German anti-aircraft artillery. Bomber Command also lacked long-range fighter escort to protect the bombers in daylight raids, so they had to restrict themselves to night time bombing. At the beginning of the war, navigational equipment was rudimentary and it was difficult to locate targets; even when they were large cities. It was therefore no surprise that some crews ended up bombing 'wild' and 'wide'. In a report to Winston Churchill, the British war prime minister, it was stated that on an average mission only 1 in 3 bomb drops would get within 5 miles of the target; in France the figures were 2 in 3, in most parts of Germany 1 in 4 but over the heavily defended industrial Ruhr district the figures dropped alarmingly to 1 in 10. In 1941, 700 British aircraft failed to return from bombing missions.

## **STRIKING AT ENEMY MORALE**

Bomber Command knew that the aircraft they had in operation were not efficient enough to hit small targets with precision and, in an Air Staff Directive of the 14th February 1942, confirmed that the bombing campaign should be conducted against the morale of the enemy civilian population; especially the industrial workers. It was thought that worker discontent was the weak link in an industrial state and that the devastating effects of bombing would tip the balance and ferment revolt. This line of thought was coloured by the events of the Russian Revolution. It was to prove mistaken. In reality, the effect on the population's productivity was minimal and the workers' morale remained high, even after 'dehousing'.

## **THE NEW BRITISH BOMBERS**

At the beginning of the war the British bombers available to Bomber Command were the Hampdens, Whitleys and Wellingtons; all suffered from an inability to carry heavy loads. They were succeeded by Stirlings and Manchesters which were too under-powered for deep penetration into enemy territory. In 1942, the Halifax's and Lancasters came into production. They had excellent performance, were built to



*A Lancaster bomber is silhouetted against a background of fire and heavy flak in the 94th raid on Hamburg by the RAF. 8000lb and 4000lb bombs were dropped on the largest German U-Boat construction site.*

withstand heavy attack and could carry massive bomb loads. After the arrival of these planes, Air Chief Marshal Harris pushed forward his plan for more 'area bombing'. On 28/29th March Lubeck was bombed and the strike force returned with only 5% losses, the figure thought to be acceptable by Bomber Command. This raid was followed by an attack on Rostrek.

The Luftwaffe retaliated with the 'Baedeker' raids on Norwich, York, Canterbury, Bath and Exeter; named after the guide books the Luftwaffe supposedly used to find the targets. In May 1942, Bomber Command mounted their first 1000 bomber raid on Cologne carrying a load that consisted of small incendiary and large high explosive bombs. The effect was devastating.

## NEW AIDS TO BOMBING

Arthur 'Bomber' Harris single-mindedly pursued the build up of large numbers of heavy bombers and he was fortunate that, at the same time, there were new developments in design, production and target finding methods. *GEE*, a transmitter which allowed receiving aircraft to plot their position on a gridded chart and release the bombs at a pre-set point, was superseded by *OBOE* and *H2S*, a radar set which gave the navigator a picture of the ground features below the plane. Another major aid to target finding was the creation of



*Air Chief Marshal Sir Arthur "Bomber" Harris (centre) in the Bombing interpretation room in February 1944.*





the *Pathfinder* squadrons based on the new fast high-flying mosquito light bombers. The squadrons took on the responsibility for marking the targets with incendiaries or flares and then the main group of bombers bombed the markers. The *Pathfinders* were very effective and much better than the non-specialists in the bomber Groups.

## THE USA ENTERS THE WAR IN EUROPE 1942

In the Spring of 1942, the US 8th Air Force arrived in Britain and the strategic bombing campaign was henceforth conducted by two Air Forces. The US bombers began their campaign in August with a daylight attack on Rouen, France. The concept of daylight bombing was one that ranked very highly with US Air Force commanders. They knew they had the right tools for the job; the B-17, that could deliver good size bomb loads, and a bombsight, the Norden, that was very accurate. The B-17 had a long operating range, could fly at high altitude and had a heavy defensive capability. By January 1943 there were 500 B-17's available to fly missions deep into Germany.

## THE CASABLANCA CONFERENCE

In January 1943, the Allies came to a formal agreement for a combined bomber offensive. They listed a large number of targets in the following order of importance: submarine construction yards, the aircraft industry, transportation, oil installations and other war industry centres. The conference also highlighted the differences between the Allies' concept of bombing. General Ira C. Eaker, the Commander in Chief of the US 8th Air Force, did not agree with British 'area bombing'. Instead he believed in precision, daylight raids on identifiable 'bottlenecks' in the German war economy that could be hit hard to produce the maximum effect.

10th July 1942

### US Flyboys Smash Targets in Nazi-Occupied Holland

It was the first communique to be issued from the European Theater of Operations:

"In a joint operation with RAF light bombers, six American aircrew attacked targets in German-occupied territory today.

"Two American planes are missing.

"The American crews flew A-20 type aircraft (Bostons) in a daylight minimum altitude attack."

Their targets were airfields in Holland.

The daring low altitude, cross-channel flight in broad daylight brought a message of admiration from British air force officials who applauded the raid as a daring event which, occurring on July 4th, symbolised American ability once more to strike a blow for freedom.



## THE SCHWEINFURT RAID

The first such 'bottleneck' was the ball-bearing plant at Schweinfurt in central Germany. Ball-bearings were essential to anything that had gears; from submarines to tanks. The US 8th Air Force bombed the plant on the 17th August 1943 but the mission was a complete disaster. The bombers had to cross northern France and half of Germany in daylight without fighter escort and they were cut down by the German fighter planes. Of 229 B-17's, 36 were shot down; a loss rate of 16%, three times the figure regarded as acceptable by Bomber Command. Also 24 B-17's were shot down in a raid on a secondary target at Regensburg with 100 of the returning planes severely damaged. From that point the 8th Air Force chiefs decided to suspend long range missions without fighter escort until fighters could be adapted to accompany them most of the way to the target.



*A B-17 having landed without brakes and with half of its flying controls shot away was stopped by an empty Nissen hut. The Fortress was damaged over France but made it safely back to base.*

23rd August 1942

### B-17's Begin Daylight Raids On France

Bomb laden Flying Fortresses hit hard at German occupied France in high altitude daylight raids smashing a railway terminus at Rozen on Tuesday, attacking a German fighter base at Abbeville Wednesday and bombing a railway yard and other targets at Amiens Thursday.

All planes returned to their bases and a radio operator with an injured foot was the only casualty. The raids proved that the efficiency of the secret bomb sight is no myth.

Twenty-four Fortresses took part in the raid on Abbeville, but one of them

had mechanical difficulty with the bomb doors and jettisoned its bombs in the English Channel on the return trip.

Accompanying the B-17's were 500 Spitfires, the greatest number ever to carry out a sweep. No enemy fighters were encountered.

Wing Commander Kinross who led the escorting formations said after the Abbeville raid:

"The US bomber boys were great. They did not waste any bombs."

Twelve bombers participated in the first all-American raid on the continent.

## BRITAIN STRIKES AT THE GERMAN INDUSTRIAL HEARTLAND

Meanwhile, between March and July 1943, British Bomber Command carried out major attacks on Germany's industrial heartland; 800 aircraft went on 18,000 sorties and dropped 58,000 tons of bombs.





When attention was switched to Berlin, 1.5 million people were made homeless and 2,000 acres laid to waste. This campaign was only halted in order to provide bomber support for the invasion of Europe in June 1944.

In raids over Germany casualties among the Allied air crews had risen to 10%; double the level that was deemed to be acceptable. Since crews were expected to fly, on average, 30 missions before being rested, the probability of being shot down before the end of a tour was very high. In practice, crews with over five missions under their belts survived longer than rookie crews. The increased losses reflected the development of German defensive measures. From 1942 onwards, German fighter control was improved and night fighters were radar equipped so that they could be guided by the ground radar Wurzburg stations. The RAF response was to equip their planes with radar detection devices and drop 'chaff' or 'window' to interfere with the radar signal. German fighters in turn used devices that homed-in on the bomber radar emissions and used these signals as target finders.

### **THE EFFECT OF THE US LONG-RANGE FIGHTER ESCORT**

At the beginning of 1944, the US 8th Air Force had 1000 B-17's and B-24's in operation. Under new commanders Spaatz and James Doolittle, and with the assistance of P-47 Thunderbolts and P-38 Lightnings fitted with drop tanks, they could now penetrate deep into Germany and bomb targets that were well defended by the Luftwaffe. In March 1944 a new fighter, the P-51 Mustang, appeared that could fly to Berlin with an operational radius of 600 miles but with the performance of a fighter/interceptor. The Allied heavy bombers could now inflict damage on most parts of the Third Reich. The German economy was to be put under severe pressure.



*A flight of P-47 Thunderbolts. Each aircraft packed a formidable eight high muzzle velocity 0.50 calibre machine guns.*

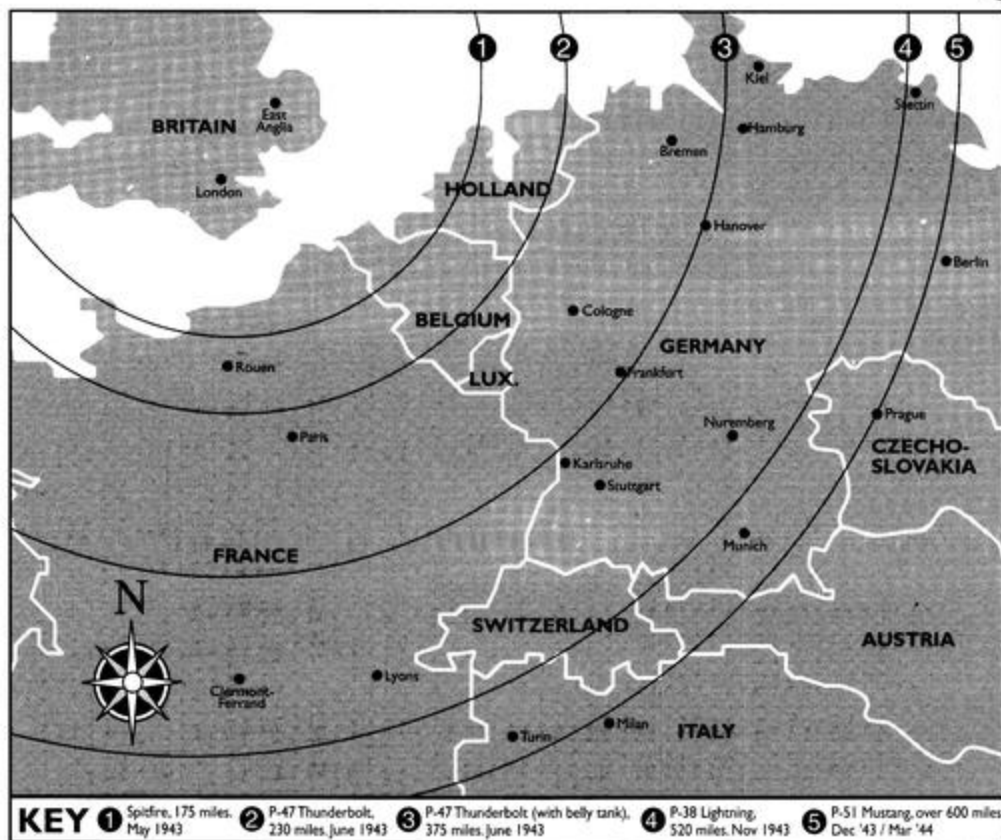

The increasing range of the bomber escort fighter.

25th December 1944

### Huge Bomber Force of 5,500 Planes Rocks Von Rundstedt

The largest force ever assembled for a single mission, in excess of 2,000 Forts and Liberators slammed communication and supply centres of the German offensive against Von Rundstedt's forces.

Flying in columns 400 miles long so that as the first squadrons reached Germany the last planes were taking off from England!

## THE GERMAN WAR ECONOMY

The German economic strategy was very similar in concept to that of the *Blitzkrieg*: a speedy victory at the beginning of the war would release German industry from the pressure of having to build vast numbers of war materials. Once it was clear that the war would be a protracted affair, the original economic strategy shifted. The push was for grabbing the raw materials of the occupied enemy: coal, metal and, most important of all, oil.

In Germany, the economic emphasis was also forced to change. Up to 1942 Hitler had insisted that the military effort should not be reflected upon civilian living standards



30th July 1944

### Forts Smash Big Nazi Factories

US 8th AAF punched holes in the Reich industrial machine yesterday. 1,200 heavies attacked engine factories, fighter assembly plants, synthetic oil plants in the Leipzig area.

22% in 1942, 31% in 1943 and 40% in 1944. But there was no attempt to match the Allies' production in terms of numbers.

## QUALITY VERSUS QUANTITY

11th October 1943

### Super Forts Blast a Path to Berlin

German radio reported stories of 'Super Flying Fortresses' that carried no bombs but were leading USAAF raids against Germany.

Nazi commentators called the planes 'four engined fighters' with 0.50 calibre guns placed in extra positions than the basic B-17. The report continued that they were trying to clear the sky of German fighters before the main formation arrived.

USAAF sources refused to comment.

and that consumer goods should continue to be produced. By January 1942, he was forced to agree to armaments minister Dr. Albert Speer's plan that military production as a percentage of the Gross National Product would have to increase. This did happen quite spectacularly. For example, the production of armaments as a proportion of GNP was 16% in 1941,

German thinking was based on the idea that the armaments they produced should be technically superior to the enemy's. For example, German tanks and small arms were always of the highest quality. The Schmeisser MP-40 sub-machine gun was the best in use in any army and also the easiest to manufacture. The designers had reduced most of the components to parts that could be stamped out by machines. The idea of quality carried through to the concept of secret weapons such as the V.1

3rd June 1944

### Calais Hit by Heaviest Attack of War

Massive fleets of US heavy bombers roared over the Pas de Calais Channel ports to inflict the hardest single strike of the war. 1,700 USAAF bombers struck at the 'so-called' invasion coast.

7th June 1944 (D-Day plus 1)

### Fleets of Allied Planes Pound Nazi Targets

Allied aircraft strafed and bombed hundreds of miles of French beaches, giving the invasion force undisputed mastery of the air. Between 12 midnight and 8am, 33,000 Allied airmen flew over French skies in 20,000 sorties. Despite the huge number of planes it was reported that only 1% of the aircraft were lost.



23rd March 1944

## 1,500 Tons Dropped on Berlin. Luftwaffe Refuses to Fight

Unchallenged by the Luftwaffe, Flying Fortresses bombed the German capital for the fifth time. used scientific cloud bombing methods. Flak was the heaviest yet experienced over Berlin said the flyers.

It is believed there were 600 heavy bombers, escorted by 800 fighters. Berlin was shrouded in cloud and US bombardiers Mustangs, Thunderbolts, and Lightnings swept back and forth unopposed over Germany for over six hours.

flying bomb and V.2 rocket. However, the philosophy of quality was difficult to put into practice in aircraft production. After 1942, German propeller-driven aircraft design fell behind British and American models and from that point Germany could never manage to produce an effective strategic bomber. The Luftwaffe single seat fighter, which had been used so effectively from its initial design in 1934, had reached the end of its life by

1943. Newly-designed heavy fighters were all unsuccessful while the first jet-propelled fighter, the ME 262, was extremely effective but limited in numbers. If Hitler had allowed mass production of these aircraft it could have made an enormous impact upon the allied strategic bombing campaign.

## THE EFFECTS OF ALLIED STRATEGIC BOMBING

By June 1944, the German standard of living began to fall drastically as the effects of the strategic bombing campaign were being felt. The vast number of imported workers soon became a drain on the war economy rather than a benefit. In the autumn of 1944 war production slumped. Oil production, most important for tanks and aircraft, suffered badly. By September 1944, as a result of the Allied bombers' oil offensive production fell from 316,000 tons to 17,000 tons. Production of aviation fuel also fell to 5,000 tons and, by early 1945, most of the Luftwaffe reserves were used up. In fact,

24th November 1944

### V2 Rocket Factory Pummelled by Forts

A secret weapons V2 factory and assembly plant near Weimar was smashed by Fortresses of the 8th AF. Approximately 130 bombers dropped a concentrated pattern of bombs.

8th AF aircraft were grounded yesterday by bad weather.



**27th August 1944**

**German Oil Output  
Halved in 90 Days**

A record task force of 1,900 British based heavy bombers battered seven enemy oil production centres as part of a 90 day campaign that has slashed Nazi oil and gasoline production by 50%.

Germany would have been unable to continue the war beyond Christmas 1944 if there had not been a revival in production at the Politz synthetic oil refinery.

It's difficult to assess the true effectiveness of strategic bombing but it was obvious that the morale of the German people was never broken by the bombers. At the end of the war, it was estimated that 800,000 civilians had been killed as a result of the bombing campaigns, the US 8th Air Force lost 2,400 bombers and British Bomber Command had lost 55,000 aircrew.









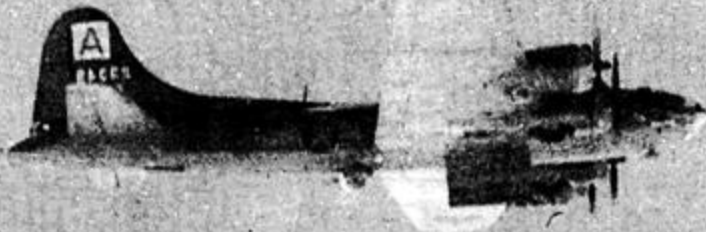

# The Development of the Bomber Aircraft





# THE DEVELOPMENT OF THE BOMBER AIRCRAFT

**I**N 1929 the Handley Page Hinaidi was a typical modern bomber. It had a maximum speed of 115 mph at 5,000 feet but at 15,000 feet this fell to 98 mph. As the aircraft climbed, the pressure of the fuel-air mixture entering the cylinders also fell and therefore power from the engines was reduced. With a bomb load of 1,500 lbs, and operating at 5,000 feet, the Hinaidi could only reach a speed of 75 mph and an operational radius of 100 miles. By reducing the bomb load to 500 lbs the aircraft could extend this radius to 275 miles. There was a four-man crew who sat in the open, had three hand-operated machine guns and who used a simple vector type bombsight.

## THE PRE-WAR DECADE

### Engine power

This was one of the most important developments from which all other designs flowed. In the decade before 1935 new engine technology produced a 50% increase in power while at the same time reducing engine weight per h.p. and fuel consumption per h.p. by 20%.

### Aerodynamic Shape

In the wake of this increase in engine power, attempts were made to reduce drag (or wind resistance) created by the basic shape of the aircraft. One of the most difficult problems facing designers was the fixed undercarriage and this was solved by introducing retractable wheels. Similarly, the familiar second wing and struts were eliminated giving a cleaner line at cruising speed.

One side effect of the single wing design was that landing speeds were much faster and wing loadings were very high. To cope with these problems there were major developments in braked wheels, wing flaps and variable pitch propellers. In effect, these design improvements meant that bomb loads could be increased.

### Flaps

When wing flaps were introduced in aircraft design they increased the lift obtained by the wings by 50%. This meant that much smaller wings could be used to achieve much higher wing loadings. Partially-lowered flaps enabled bombers to lift heavier loads and, when fully lowered, could make the aircraft fly at much slower speeds and so conserve fuel. Flaps also served as good air brakes.



## The Variable Pitch Propeller

This development converted engine power into thrust much more effectively with the result that less power was wasted during take off or in cruising and a saving on fuel extended the range of the bomber. The variable pitch propeller also enabled the pilot to feather the blades (turn them end-on to direction of travel) until they gave a drag value of 0% if the engine failed.

## The Supercharger

The supercharger allowed a greater mass of air and fuel mix to be thrust into the cylinders at heights where the air was thin. Full power could be achieved at very high altitudes with the added benefit of less wind resistance.

The aircraft could therefore fly faster, further and higher on the same power and, at the same time, make itself a more difficult target for anti-aircraft artillery and fighter interceptors.

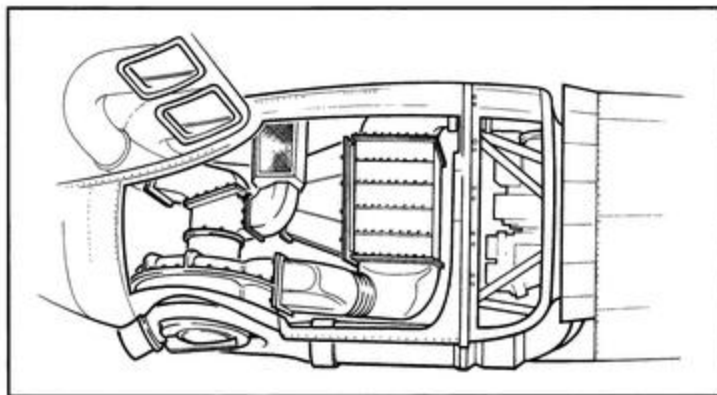

*The turbo-supercharger was installed in each of the four engines of a B-17 and gave it the ability to fly at high altitude without loss of power.*

## The Airframe

The traditional fabric covered frame was replaced in this period by an all metal stressed skin which made the aircraft body stiffer and stronger.

## The B-10

All the above developments, except supercharging, were incorporated in the Boeing B-10 built in 1934 for the US Army Air Corps. The crew positions were enclosed, the nose gunner was given a turret and the bombs were placed in a proper bay. At the time, there did not seem to be a combat fighter that could intercept the B-10. The B-10 was to be the model upon which all WW2 bombers, including the B-17, were based. It was no wonder that Brigadier General Oscar Westerner declared that, "No known agency can frustrate the accomplishments of a bombing mission."



## DEVELOPMENTS DURING THE WAR IN EUROPE

In 1939, the B-17 Flying Fortress was the most State-of-the Art bomber in the air. The B-17A was bigger than any other current bomber with a take off weight of 42,600 lbs. It had four 930hp Wright Cyclone R-1820-F65 9-cylinder radial motors, a maximum speed of 256 mph at 14,000 feet and, with a 2,000lb bomb load, could operate in a radius of 900 miles. The B-17A had five .30-calibre machine guns located in the nose, mid-upper, ventral, and two in the waist. When the war broke out, the type B-17B was just rolling off the production line in Seattle. It had new turbo superchargers fitted that could push its operating ceiling from 14,000 to 25,000 feet. The B-17 was to change radically over the next six years.



*Filling in time between briefing and take off, four gunners clean and assemble their machine guns; each one marked with its correct position.*

and electrically fed with ammunition. The defensive capabilities of all early bombers against attack from underneath were usually minimal and the only really successful manned turret was the US Sperry ball type that was fitted to the B-17 and B-24. It was unique in that it was electro-hydraulically powered and the gunner lay on his back to operate it.

### Gunsights

At the beginning of the war, gunsights were the simple ring and bead type in which a gunner had to maintain a constant eye base. Accuracy depended on the gunner's skill in calculating deflections (the swerving path of fire towards the target) but it was still extremely difficult to hit a moving object. These were eventually succeeded by the reflector

## Defensive Machine Guns

### Turrets and Mountings

Originally, most bombers' defensive armaments were single hand-operated machine guns pivoting on a mounting attached to the structure of the plane. The main disadvantages being that it was always difficult to turn the gun into a 200mph slipstream and therefore the field of fire was severely limited. The next development was to give the gunner a rotatable mounting so that he could pivot towards the enemy. The slipstream problem was overcome by installing powered gun turrets which traversed the turret and the gun mounting ring, leaving the gunner free to control movement in azimuth and elevation by hand. Powered turrets soon became very sophisticated. Guns could be moved at 50° per second and gunners could literally sign their names on a card if they placed a pencil in the gun barrel. Guns on a B-17 were electrically fired



sight; essentially an optical sight that left the gunner freedom to move his head to and from the sight without creating an error in deflection. The gunner had only the target to watch with the reticule in the optical viewer superimposed on it. By the end of the war most bombers either had gyroscopically predicting sights that gave very accurate deflection shooting, regardless of the relative position of target and gun, or compensating sights that took account of the forward speed of the aircraft and related it to the trail and motion of the enemy fighter.

### Ammunition

B-17 guns used a mixture of armour piercing, incendiary and tracer bullets. Tracer rounds were of dubious benefit as they made gunners disregard their sights and follow the tracer path. This created a serious



*The tail gunner off a Flying Fortress aims through the ring-and-bead type gunsight.*



*The flak vest stopped a 20mm incendiary shell worn the waist gunner. He was knocked breathless but recovered and later shot down two enemy fighters.*

optical illusion which made them think they were on target when they were not. Tracer rounds did however alert other gunners in the formation that the enemy fighters were close and also had added deterrent effect on enemy pilots.

### Electronic Defences

#### Carpet

With developments in radio and radar, bombers had to be equipped with new machines that could perform special tasks. To protect them from radar laid flak they used a 'Carpet' noise jammer which radiated over a narrow band of frequencies. In an operating squadron, the 'Carpet' in each bomber was tuned to a slightly different frequency. This meant that they could jam across the entire German band used by the Wurzburg flak control radar.





## Window

A simpler method of jamming was to release lengths of aluminium foil cut to roughly half the wavelength of the radar they were trying to counter. Bundles were released from the bombers in order to create a large number of fake targets. In vast quantities, the effect was quite startling; radar could be blotted out completely. The RAF called this 'Window', the US 8th AF 'Chaff' and the US Navy 'Rope'. By the end of the war, the US 8th AF was dropping 2,000 tons of foil per month on bombing missions.

## Target Finding

### Pre-War Navigation

Air navigation has always been difficult over sea, above clouds or at night; unless ground features were visible it was very easy to drift off target. Pre-war radio navigation techniques, first used in the 1930's, consisted of single radio direction finders on which the aircraft homed in. The next major step forward was the directional beacon which laid down beams as set routes. One such type was the German Lorenz system. This was a short range ground transmitter which radiated a double beam with morse dots and dashes. When the two beams overlapped, and the navigator could hear a continuous tone, he knew the plane was flying along a narrow precision route.

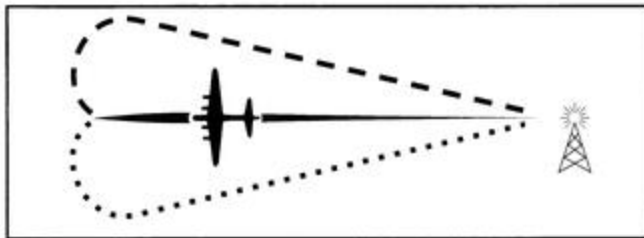

### The Lorenz Beam

*A short-range ground transmitter which sent out a twin beam of Morse dots on one side and dashes on the other. The narrow section where the two beams met produced a steady tone along which the plane flew. This system was originally used before the war to help aircraft land in conditions of bad visibility.*

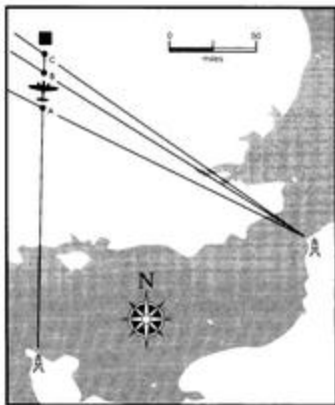

### German War Systems

The Luftwaffe's 'Knickebein' was based on the Lorenz system. It was further refined into a larger 4 beam version called 'X-Geraet'. This used an approach beam and 3 intersecting cross beams which automatically released the

### X-Beams

*The German bomber followed the approach beam. Beam A gave warning that it was near the target. The bombing clock was started after Beam B signalled 20 km distance. On crossing Beam C, from the target, a second button was pressed on the bombing clock which automatically released the bombs at the correct release point.*



bomb at the correct bombing point. Unfortunately, X-Geraet proved to be unwieldy, required special training for operators and heavy receivers had to be carried aboard the aircraft.

### Gee

The RAF's GEE worked along similar but less complicated lines than the German systems. It allowed the aircraft to fix its position by timing the pulses of radio emissions from 3 ground stations. These were displayed as blips on grid lines across a radar scope. GEE co-ordinates could then be transferred to data charts. Accuracy was reduced with distance but it was possible for the navigator to get within 5 miles of the true position. GEE operated at a maximum distance of 350 miles depending on weather conditions. By the end of 1943, half the aircraft in US 8th AF were equipped with GEE.

### Oboe

OBOE was essentially an RAF 'blind-bombing' system. It differed from GEE in that position was determined by two ground stations that measured distance by re-radiating signals aimed at the aircraft. Range was about 280 miles at 28,000 feet.



### OBOE

*One ground station followed the plane along an arc passing through the target, the second station worked out the range and signalled when the bomber had reached the bomb release point.*





## H2S/H2X

H2S and H2X were later developments of target finding systems. They worked by scanning the ground features under the aircraft. Echoes from built-up areas bounced back with greater strength than those from open country and echoes from water were minimal. Thus, a signal could be displayed on a cathode ray tube, placed in the bomber, that was like a picture of the ground below and could then be studied with reference to an accurate map. These devices were quite heavy and cumbersome, but this was not a problem on a heavy bomber. H2S and H2X had the advantage that there was no maximum range limit. The disadvantage of H2S was that good target recognition depended on the terrain. The Germans countered these devices by building a machine called 'NAXOS', that could track H2S/H2X emissions and help their nightfighters or flak units locate the bomber formations.

## Horizontal Bombing.

This was the usual method of bombing for the B-17 and other heavy bombers that had downward looking sights. Pattern bombing was the favoured system in which all planes held formation and released simultaneously on a signal from the lead bombardier. Ideally, this system produced a concentrated bomb pattern aimed by the best bombardier. Once the German flak gunners caught on to this procedure, they invariably concentrated their fire on the lead plane in any formation, making it a very hazardous position to be in and survive.

## Bombsights

In the majority of cases bombs were aimed visually, by aircraft flying horizontally from a great height. Two basic types of bombsight were used:

### The Vector Sight

The bomb aimer had to set the aircraft speed and altitude, determine wind speed, direction and the bomb load ballistic data. He would look at a sighting cross made of thin pieces of wire, or lines of light on a screen, which showed where the bombs would hit if dropped at that particular moment. The Vector Sight needed a long horizontal approach and was not suited to a monoplane which tended to shift sideways as it banked for turns. In 1942, the RAF produced the Mark 4 which was gyro-stabalized and allowed the aircraft to make banked turns on a bomb run. It worked by passing the data to a complex analogue computer which corrected the sight to take account of any course deviation.



## Tachometric Sight

During a bomb run a bombardier looked through a sighting telescope at the target. The sight was adjusted by a variable speed electric motor. The bombardier input bomb load and altitude data, then set the telescope sight over the target. The base of the sight was gyro-stabilized and, by keeping the telescope on the target, aircraft movement information was fed into the sighting computer. The computer produced course correction signals that were channelled to the pilot's panel. When the bomber was close to the target, the sight telescope was almost vertical and the computer calculated when the release angle had been reached. Then a series of electronic contacts were closed and the bombs dropped automatically.

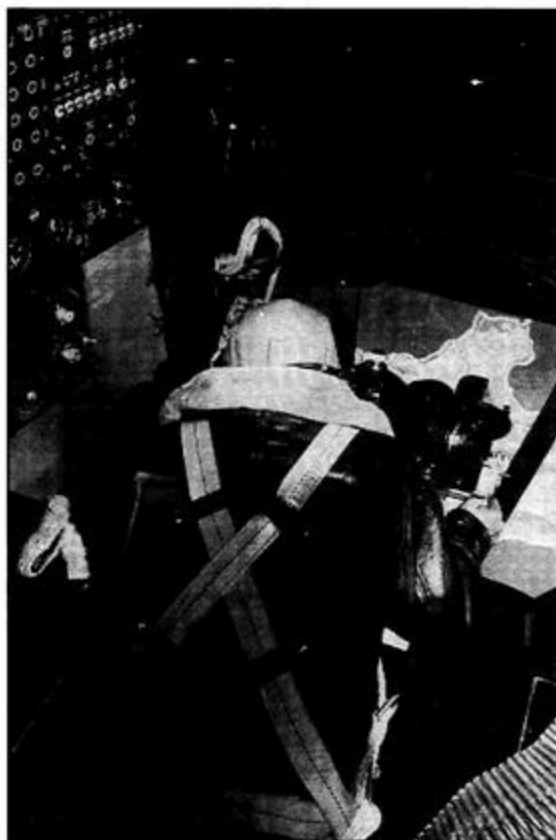

*A bombardier crouches over a Norden bombsight lining up the target in his sighting telescope. In later models, he would actually be flying the aircraft by gently moving the sighting telescope.*

The US version of the Tachometric sight was called the Norden. Later models of the Norden channelled data directly into the auto pilot and effectively, the bomb aimer could 'fly' the plane by fine adjustment of the sighting telescope. The main disadvantage of this sight was that it needed at least 20 seconds of non-deviational flight. It also lost accuracy if fire and smoke obscured the target.



## Machine Guns and Ammo

### The Zone Firing System

The hand held weapons in the B-17 were not as effective as was hoped. A high number of planes were claimed to have been shot down by gunners flying in bomber formations, mainly because several gunners would be shooting at the same plane. For an average gunner, it was a matter of luck if an enemy aircraft was hit. The fact that both the gun platform and the target were moving in different directions and speeds made accurate aiming extremely difficult. The US 8th Air Force decided to implement the Zone System of firing in air combat: pointing the machine guns in the direction of the target and filling the sky with bullets, so that a passing enemy fighter would have to fly through several streams of bullets and, with any luck, incur damage.

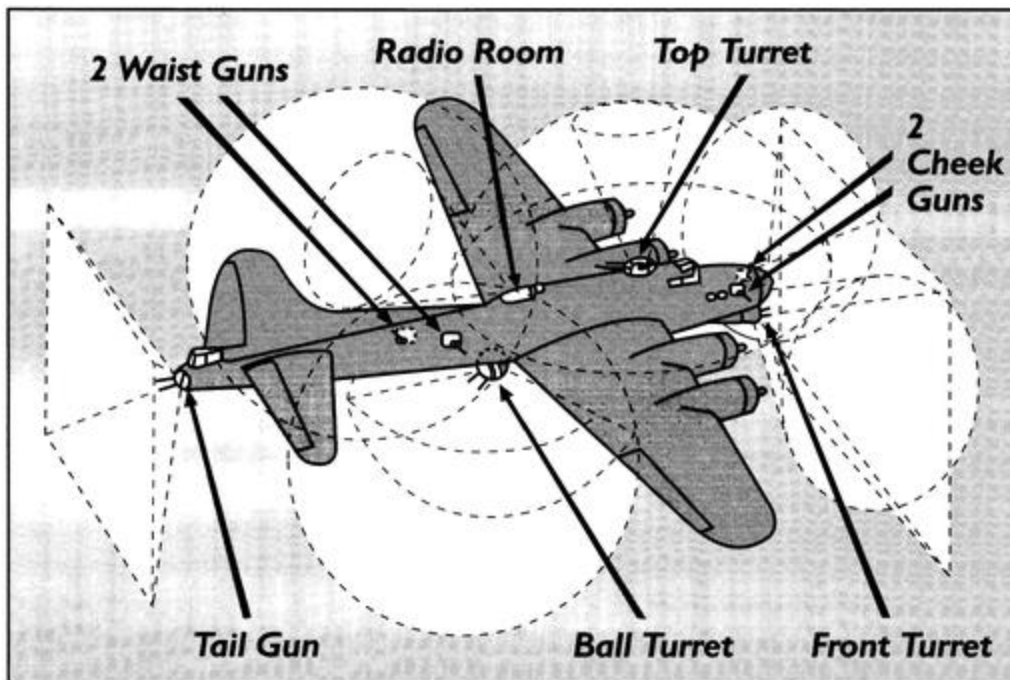

*The defensive zones of fire of a B-17G.*



### **Browning M-2 .50-Calibre Machine Gun**

The Browning M-2 was the standard offensive/defensive weapon used by the US 8th AF. It weighed 64lbs was 57 inches long, and fired 750 rounds per minute. Its effective range was 3,500 feet. The gun was the same as that fitted to bomber escort fighters such as the P-51B.

Bullets were 5.47 inches long, weighed 1.71 ounces and were available as tracer (tipped with red paint), incendiary (tipped with blue), armour-piercing incendiary (tipped with silver) and plain armour-piercing (tipped with black paint).



*A B-17 waist gunner with a belt of 0.50 calibre machine gun bullets that could be a mixture of incendiary, armour-piercing or tracer.*

### **Browning M-2 .30-Calibre Machine Gun**

Fitted in the early B-17 models as the nose armament but not used after the Spring of 1943. The B-17E and B-17F both had four sockets in the plexiglass nose to take 0.30 calibre's and the bombardier was expected to move the gun from one location to another during air combat. In practice this was not done and the 0.30 calibre's were usually left in one position. The 0.30 calibre's could fire 1,200 rounds per minute but was ineffective due to its lack of range or muzzle velocity.

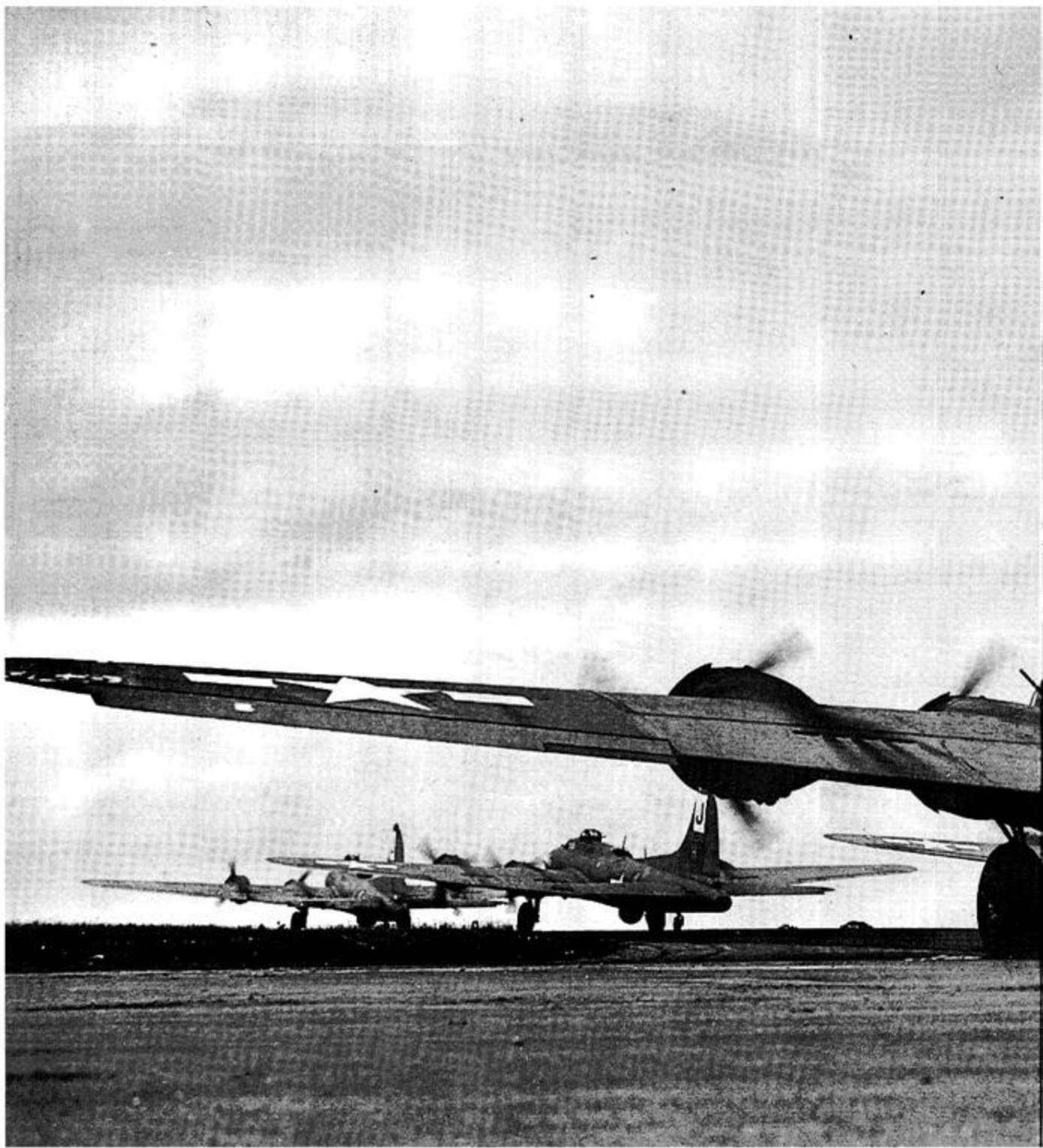

# The Fighting B17's







# THE FIGHTING B-17'S

## The B-17E

The first of the 'big tail' B-17's arrived in England to equip the US 8th Air Force in July 1942. All the planes had been modified with enlarged gun windows and 0.50-calibre guns on either side of the nose. Further modifications were made to them after they were operational including work on the radio, bomb rack, lighting, oxygen, extinguisher and survival systems. By the time the B-17E had been shipped across the Atlantic, newer models were already coming off the Boeing production line. In fact, the B-17E was only on full combat status for just over two weeks before the appearance of the B-17F's.

The B-17E was not used in great numbers for combat because the F model was so different in performance that it made joint operations, using both planes unlikely. The B-17E took a back seat and was eventually used as a trainer, a transport and target-tower.

With its armaments removed it could give better handling and speed.

## The B-17F

The main difference between the E and the F was that wide blade propellers were fitted to the new type that gave better performance. The F was made in greater numbers and had to be manufactured by three different companies; each factory had slight detail modifications. The source factory was listed by a suffix placed after the designation and block number: BO stood for Boeing, VE for Lockheed Vega and DL for Douglas. Thus, a plane with the designation B-17F-109 VE told you that it was made by Lockheed.

The B-17F's arrived in England in August 1942 and were destined to fly throughout 1943. However by the summer of 1944 they were a rare sight on operational bases. The planes were subsequently re-modified by the individual bases to cope with the unique problems that came to light in air combat. The aircraft, designed and tested in warmer climes, had to cope with the extremely low temperatures and high humidity of altitude flight. Problems encountered in the first few missions: the brushes in the electrical generators froze up, the ball turret would not rotate, guns jammed, there was blind spot in the forward zone of fire and the tail was very heavy.

By November 1942, the Luftwaffe fighter pilots had realised that they could attack a B-17F head-on and be safe from return fire from the actual plane. The fitted 0.30-calibre machine gun in the plexiglass nose was ineffective so individual Bomber Groups decided to replace it with the more destructive 0.50-calibre guns. A nose gun installation kit was provided by 8th Air Force Service Command and the importance of a forward mounted turret on a B-17 was impressed upon the manufacturers. The work on



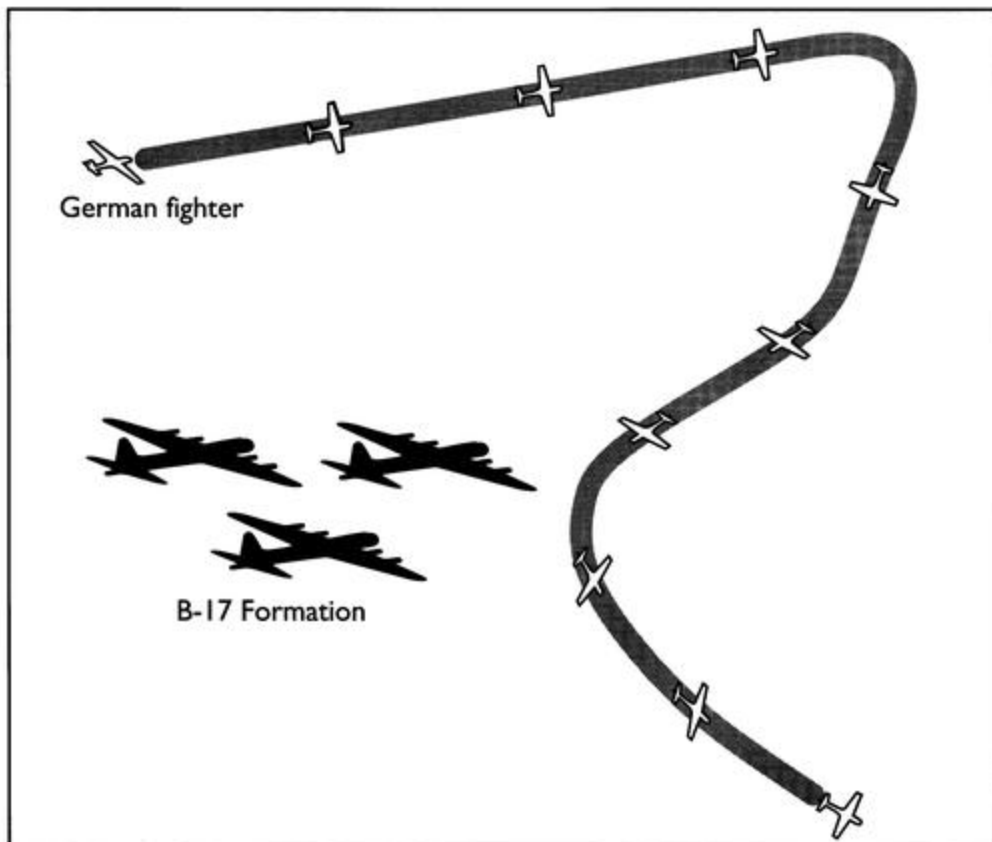

#### **Attacking a B-17 Formation Head-On**

*The Luftwaffe discovered that the early Flying Fortress had a defensive 'blind spot' when attacked head-on. There was no effective machine gun to fire forwards. German pilots adopted this tactic for swooping down on a formation and then escaping. However, once long-range escort fighters accompanied the forts to the target, this tactic could not be employed.*

converting the nose turret was very slow and could only be carried out when the aircraft was free from combat commitments. It was not until May 1943 that B-17F's with a factory fitted nose gun mount landed in Britain.

The failure of the ball turret was of greater concern on the early models. Apart from the problem with rotation, the oxygen line, throat microphone, and flying suit heater cords all became tangled during normal combat operation. The gunner also faced the risk of running out of oxygen. The bottle contained insufficient oxygen for a normal mission and it was the job of the waist gunner to re-charge the ball turret cylinder but the valve often froze open and the supply quickly emptied.



*Ground crew winch a replacement engine unit into the wing housing. The B-17 could sustain a lot of operational damage and get back to base but this meant lots of extra work for the ground crews.*

windows, re-locating waist gun sites for a better field of fire, fitting of *GEE* and changes to the oxygen system.

The cold conditions the aircraft operated in tended to freeze the bomb bay doors and the bomb shackles. In early missions this problem was overcome by one of the crew using a crow bar on the frozen mechanism. Experienced crews would test the bomb bay door operation before they were on the bomb run.

Nothing could be done to stop the plane from being tail heavy but crews were warned about storing equipment and ammunition near the rear.

Another cause for concern was the ability of the waist gunners to inadvertently fire

Other problems included a leaking hydraulic unit, and a turret door that was prone to cracking. Getting out of the turret in an emergency was also a painfully slow procedure. The gunner had to hand-crank the turret into the correct position, then lift himself out of the hatch and put on a parachute. Needless to say ball turret gunner was the least popular job among B-17 crews.

By May 1943, the US VIII Bomber Command had listed a dozen priorities for standard modifications: nose gun fittings, upper turret charging handles, armour plate protection for the pilot's panel, more ammunition for the gun in the radio room, an increase in the oxygen supply to all turrets, new radio antennae, Mark III IFF sets, a remote indicating compass and a life-raft release. There was also a list of less important changes such as bullet proof glass in



*Stripping the metal skin from the wing of a crashed Fortress at a US Bomber station; to be used for minor repairs on mission damaged bombers.*

into the wing and tail. In July 1943 an electrical cut off system was fitted which automatically stopped the gun firing pins if the gun was aimed at any part of the plane.

One of the most important changes in the development of the B-17F was the addition of extra fuel tanks giving the plane another 1080 US gallons. Effectively, this increased the B-17F's range by 1000 miles and the operational radius doubled to 650 miles. The extra fuel units were called Tokyo tanks (supposedly adding enough range so that a B-17 could get to Tokyo from a carrier in the Pacific) and were made up of nine rubber self-sealing cells placed between the ribs of both wings. These long-range versions first appeared at English bases in May 1943.



# THE B-17G

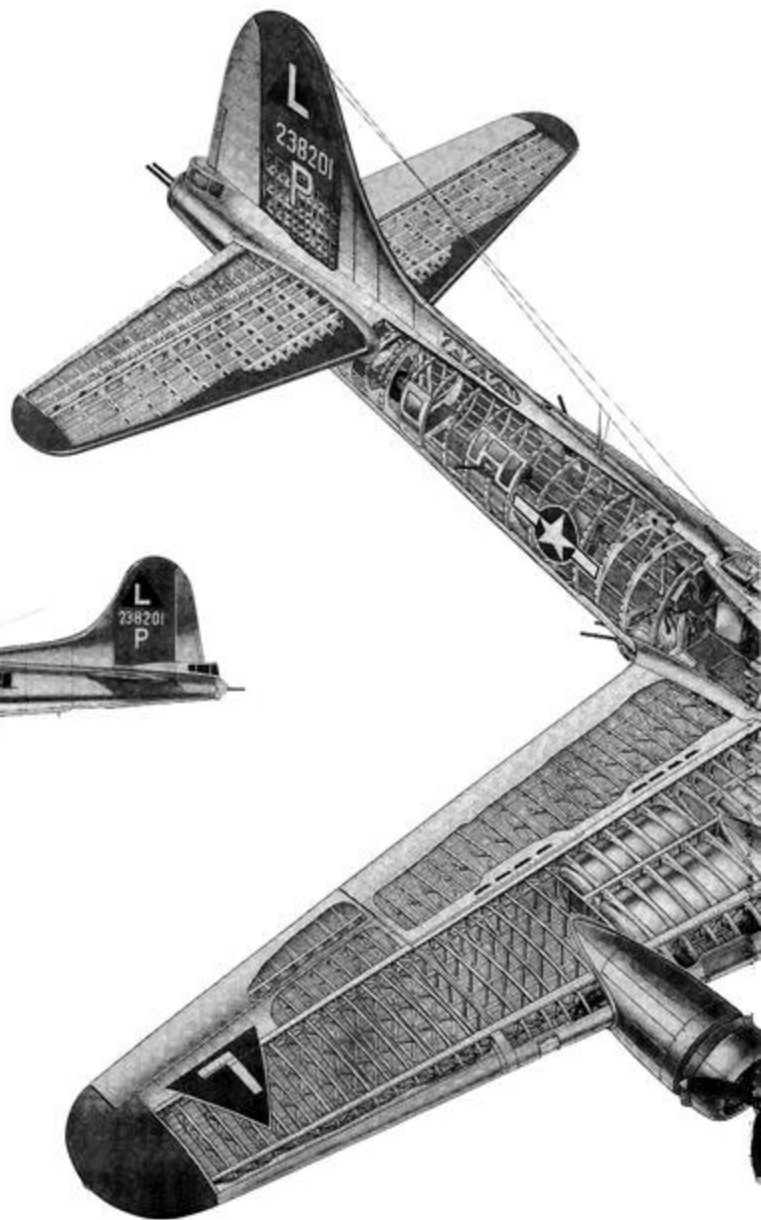

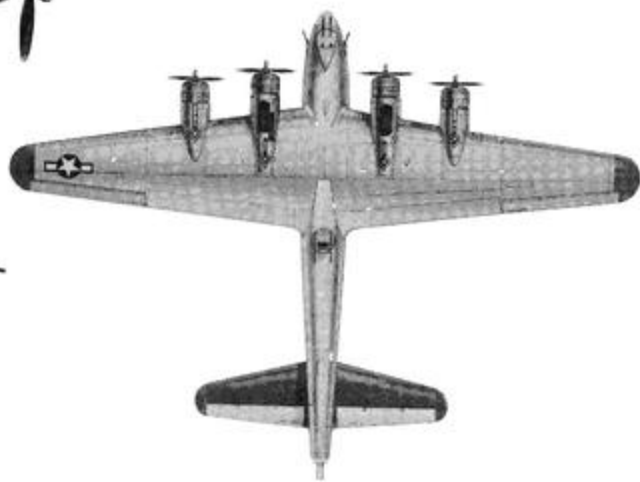
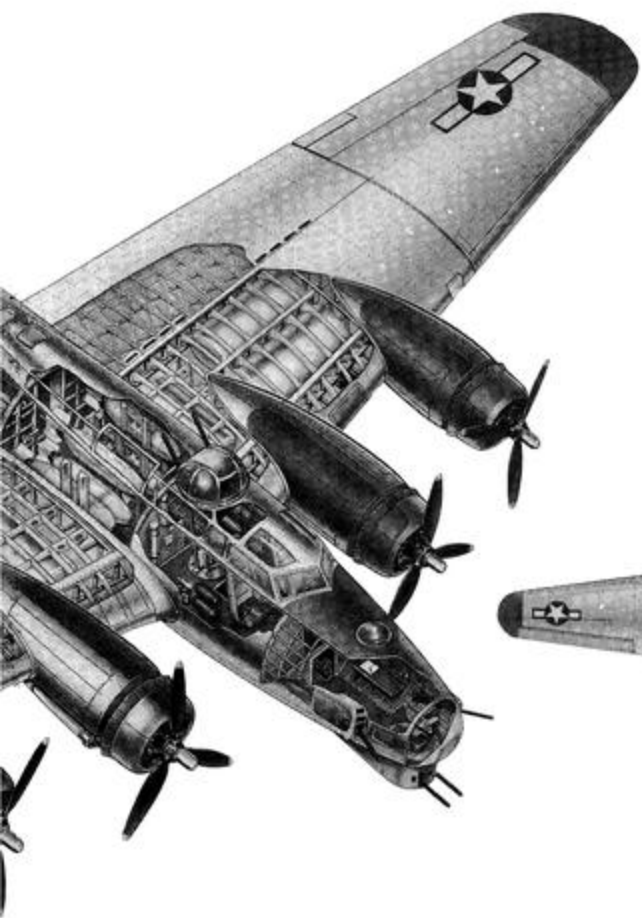



## The B-17G

The B-17G was the last production model of the Flying Fortress and was manufactured in the greatest numbers. In effect, the B-17G was the B-17F with the powered Bendix chin turret fitted under the nose section. Design modifications included the Minneapolis-Honeywell electric turbo-supercharger regulators allowing manifold pressure, or boost, to be controlled by one control knob for all four engines. The pilot no longer had to worry about over-revving turbines or

having to constantly tweak power controls to stop oil in regulator lines becoming sluggish. Another major difference was that the waist gunners were given an enclosure that protected them from the icy temperatures of high altitude with the position of the guns staggered to give them more room to manoeuvre. The tail gun position was also improved allowing a wider field of fire, a reflector sight, and hand held guns.



*The B-17G Flying Fortress without camouflage paint. It was decided to leave the aircraft in its original metal finish in later models because, at the height it flew, camouflage would make little difference. In fact, without the paint it was a lighter and faster aircraft.*



*Lieutenant Mary Churchill, the youngest daughter of Winston Churchill, christens "Stage Door Canteen" by smashing a bottle of Coca-Cola against the Bendix chin turret.*

However, the new model B-17 also experienced its own operating difficulties. When fired at maximum elevation, the chin turret guns had a tendency to crack the plexiglass nose; a problem was solved by fitting blast barrels to each gun. The oil cooler regulator often failed to operate and could result in complete engine seizure. The ability to feather the propeller blades, in event of engine failure, was lost in the B-17G because the standpipe that held back sufficient oil to work the



feathering tank was sacrificed in the quest for a lighter aircraft. This was a major design error and meant that, by the winter of 1943, the lack of feathering was a major reason for bomber loss. Urgent requests were made by Groups for special modification kits but it was only in September 1944 that B-17G's arrived with these modifications built-in.

Another serious problem on the B-17G was the lack of an engine fire extinguisher system. Designers had believed that it was ineffective so had left it out of the new model. In reality, the system had worked well and it was requested by Bomber Groups that it be re-introduced as soon as possible.

The B-17G was still tail heavy with the same centre of gravity problems as earlier models. However, by May 1944, when long-range fighter escort was effective defensive protection, gunners were not as busy as before and it was decided that one waist gunner be dispensed with. The radio room gun, the least used in action, was got also rid of and the quantity of ammunition carried reduced. All these measures brought the centre of gravity nearer to a more acceptable position. In the last months of the war, when there was little enemy fighter activity, some Combat Wings flew without waist guns, ball turrets or chin turrets. Operational reports revealed an estimated 25mph increase in airspeed with the improved streamlining. In this period of the war flak batteries were a greater hazard than fighters and unnecessary gunner armour plate was removed to be replaced with laminated steel and canvas plates called flak curtains.



*"Thru Hel'en Hi water" returned to base after a direct hit on the tail. The tail gunner was uninjured, fortunate that he was checking the tail wheel when the shell hit. Time and time again the B-17 proved it could sustain major damage and keep on flying.*

In total, the 8th AF received 6,500 B-17G's. In March 1945, it could send 2,370 of them into combat operations. *At the end of the war a total 1,301 B-17G's had been shot down or reported missing in action.*





# Missing in Action

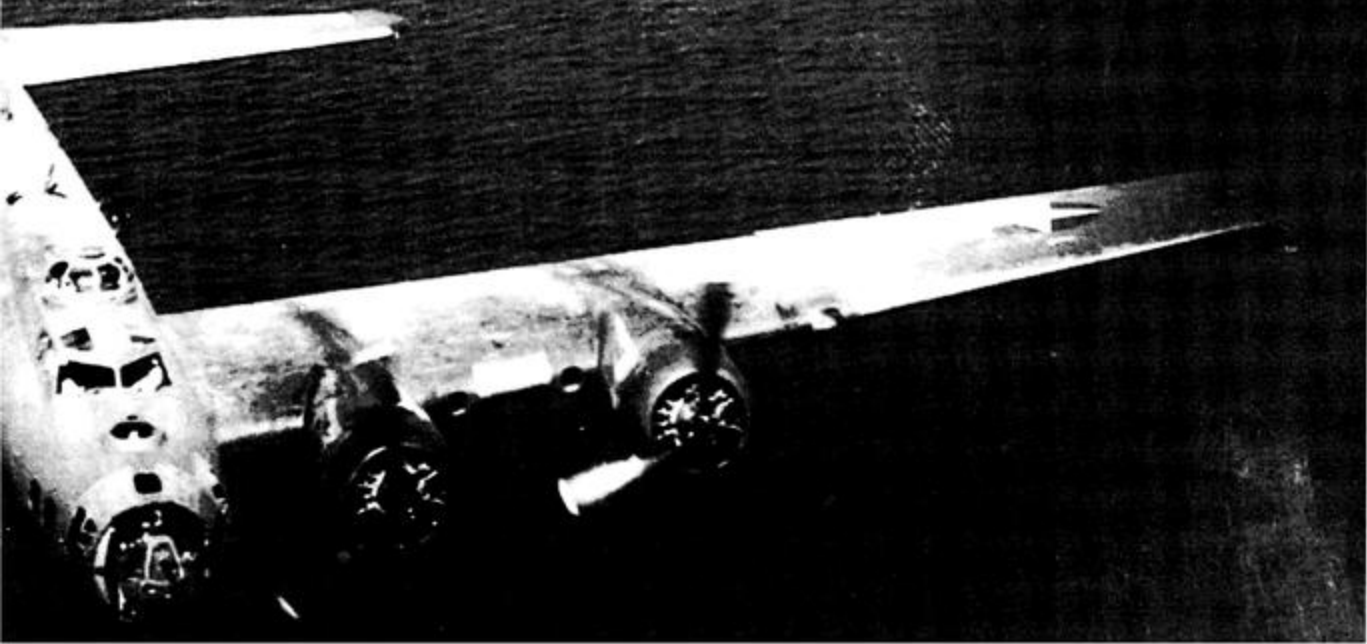



## MISSING IN ACTION

IN the autumn of 1943, B-17's formed up over East Anglia to attack the German Fw 190 fighter factory at Marienburg. *Fightin' Momma* was chosen to go with 120 B-17's for a diversionary attack at the aircraft component factory, Anklam. This was the crew's fifth mission and the B-17's 19th. The Group passed over Cromer at 1000 feet trying to fly under German radar. Unfortunately, they were spotted by the Bremmen defence area and fighters were vectored along the Danish coast on an interception course. The formation reached 11,000 feet, found the target and released their bombs. At 12.00 hours, the group were intercepted over Kiel by a force of Fw 190's. *Fightin' Momma's* engines were hit badly. The B-17 spiralled downwards out of formation and dropped. Pilot and co-pilot struggled with the spinning aircraft and managed to straighten her up. The radio operator had been hit by a cannon shell but still sent out a distress signal, then clamped the transmitter key down and returned to his gun. The pilot warned the crew to take up crash positions and wait for the impact. He managed to fly her straight and level, putting the B-17 down on a small island north of Kiel without further injuries to the crew. Unhappily, the radio operator had died from his wounds before the crash. He was recommended by the captain for a Silver Star and buried with full military honours at Kiel.

AUGUST 1944. It was a mission to destroy valuable German fuel supplies, oil depots and refineries. The B-17G in natural, shiny metal finish, flying in formation, had already passed the first turning point. They were on a direct path towards the target. There was a thick undercast between 5,000 and 20,000 feet affording good cover from enemy flak guns. The Luftwaffe defended their oil supplies tenaciously and it was not long before the formation was spotted. The bomber escort peeled away and engaged the German fighters but some of the bandits got through and swept across the formation. The B-17G, the third plane of the first element in the first wave was hit. Thick, white smoke poured out of number two engine. The captain turned away from the target, unable to maintain height. He scanned the countryside as the plane broke out of the cloud, and breathed a sigh of relief when he saw open flat countryside. He performed a perfect crash landing. All the crew were arrested, the four officers sent to Stalag Luft III and the six NCO's to Stalag Luft IV.



**F**EBRUARY 1944. *Miss Juanita*, a B-17F had had an uneventful flight to Hanover, its target for that day. When the formation had settled into its bomb run the gunners noticed shiny flecks of metal high above them; the sure sign of imminent enemy fighter attack. Four German Fw 190's peeled away in an attacking dive. They were spotted by the top turret gunner who screamed out, "Fighters at 5 o'clock!" and began to fire his Browning machine guns. One of the Fw 190's fell away from the attack, its engine spewing out oil and smoke.

"More fighters at 2 o'clock!" the co-pilot called out to alert all the gunners, just before the whole length of the plane was raked with gunfire. Tail and waist guns were firing back wildly but the top turret remained ominously quiet. The operator had been hit in the first strike. The Fw 190's continued to pound the B-17. The co-pilot, radio operator and left waist gunner were hit and the aircraft was crippled still 20 miles south of Hanover. It was obvious to the pilot that he couldn't maintain bombing formation at 25,000 feet. He ordered the wounded members of the crew to bail out at 23,000 feet knowing that they would receive prompt medical treatment and turned the plane for home. But he couldn't maintain height. *Miss Juanita* belly landed just short of the Dutch border. The crew survivors immediately tried to destroy the aircraft but they were arrested by the German Home Guard. The crew were eventually sent to a POW camp.

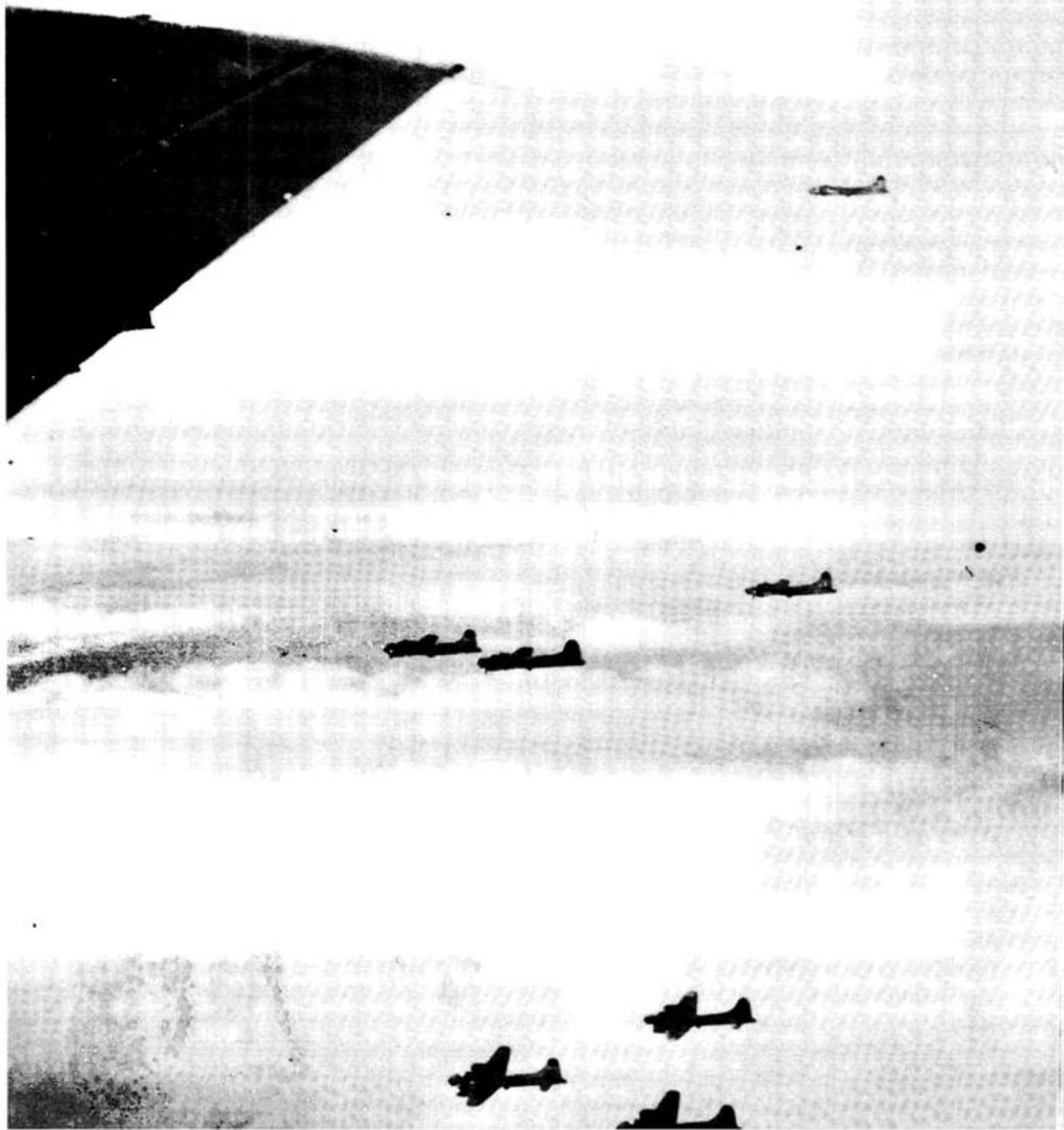



# **Flying in Formation**





## FLYING IN FORMATION

Heavy bombers flew in formation because that was the most effective tactic against the enemy flak and fighter defences. In a survey in 1943, it was discovered that just over half of the bombers shot down by the Germans during attacks on targets in Europe, were those that had to leave the main formation. Getting into formation took up a lot of

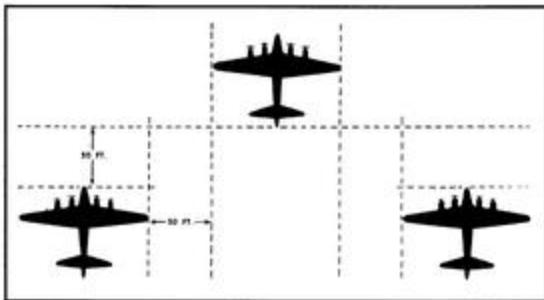

*The three aircraft Vee was the basic building block of all larger formations.*

time and effort, used up a good percentage of valuable fuel and increased the possibility of pilot fatigue. The procedure for getting a Group into correct formation also took up an hour's flying time but mission planners at US 8th Air Force knew that the procedure was essential. Between 1942 and 1945 a number of ideal formations were worked out and modified.

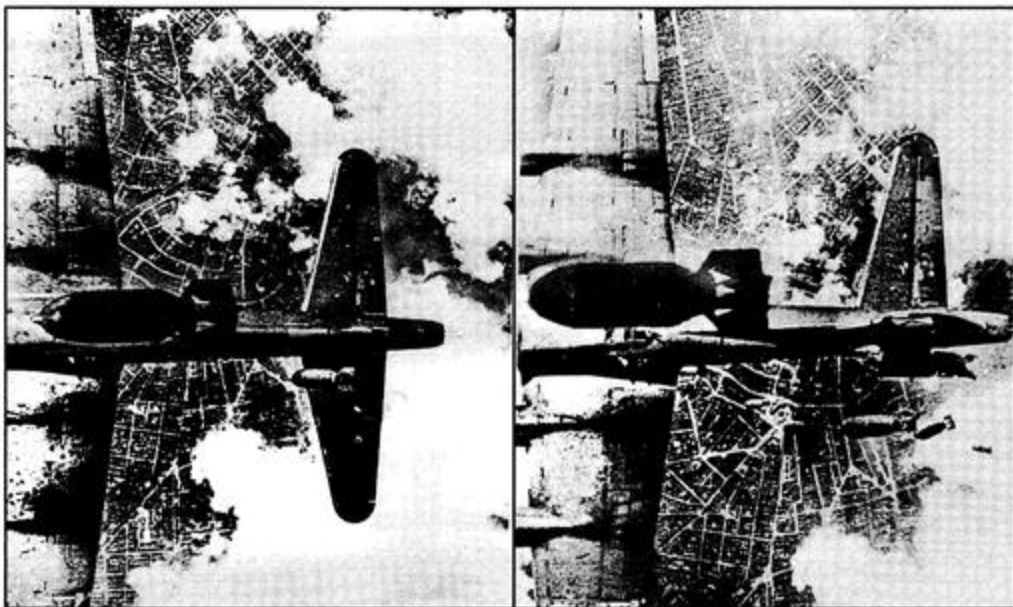

*A bomb from one B-17 hits the stabilizer of the bomber below it. A deadly illustration of the importance of correct and accurate Group formation during a bombing run.*





The B-17 usually formed up above the cloud layer (or undercast) using a radio beacon system called Buncher or Splasher. The three plane Vee shape was the basic element of all formation flying but the number of Vees in a Squadron/Flight and the number of Squadrons in a Group varied as tactics changed over time.

In August 1942, when the US 8th Air Force began its campaign, it flew in squadrons made up of 6 aircraft with each plane about 100 feet away from the next. The aim was to strike a balance between tight defensive firepower and the

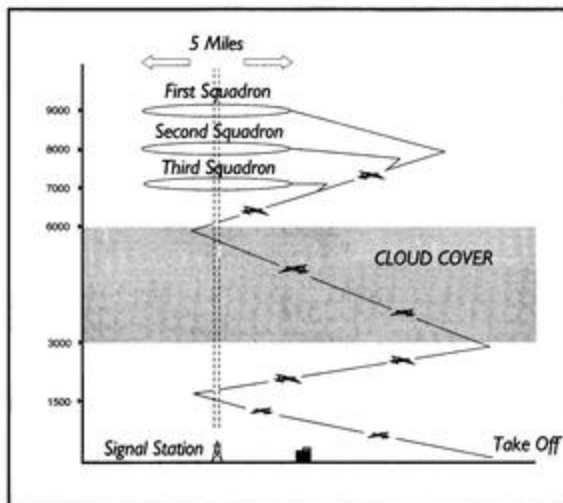

The US 8th Air Force developed this system to allow 36 bombers to form up above the clouds. A 'Buncher' signal was emitted by a radio beacon around which the bombers would circle for an hour while every flight got into the air.

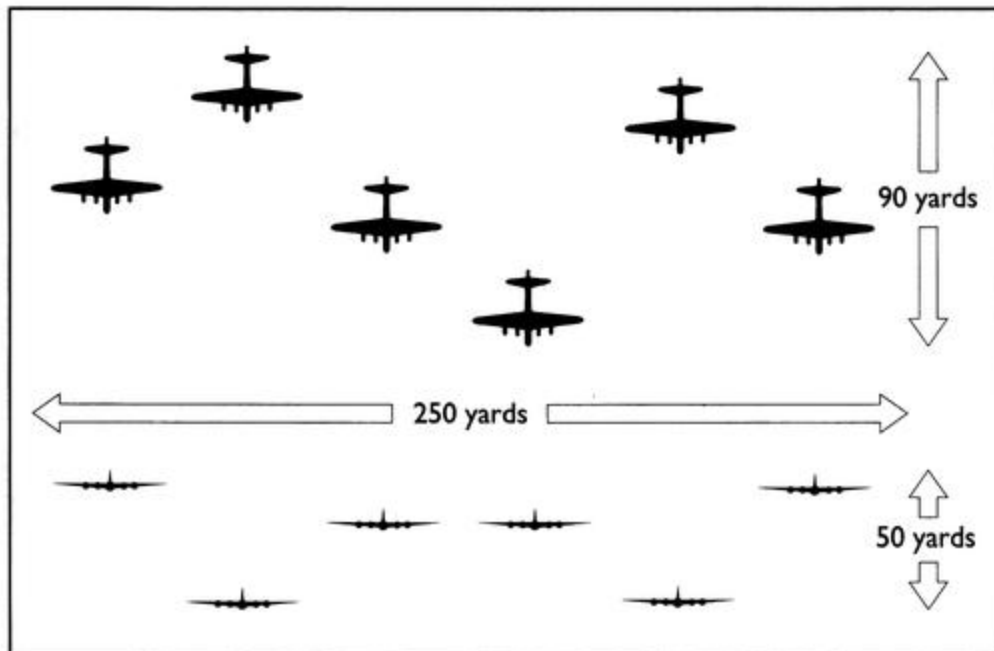

The 6 aircraft squadron flown by the USAAF from August 1942.

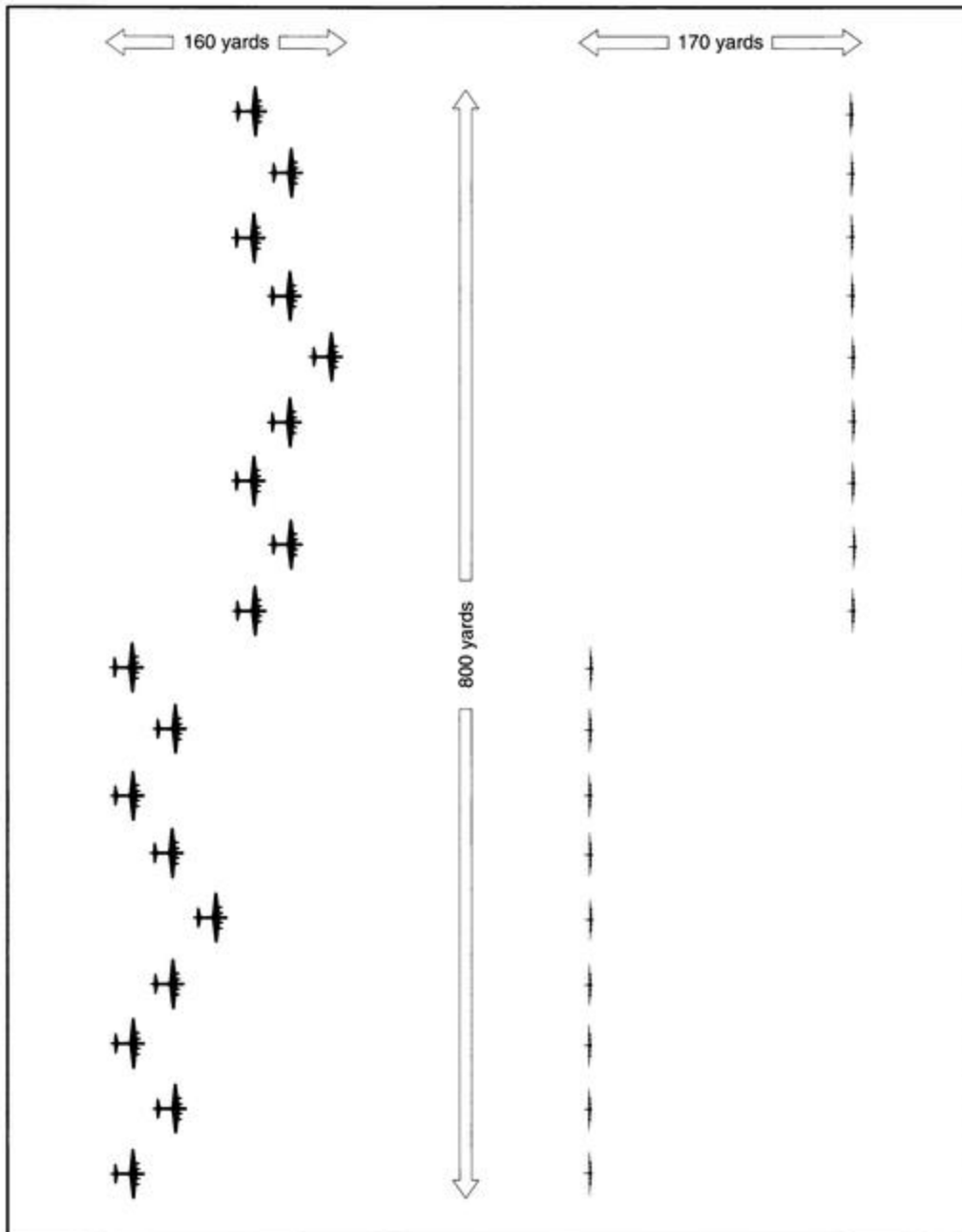

Two 9 plane squadrons with the second squadron 500 feet above the first. Introduced in September 1942.

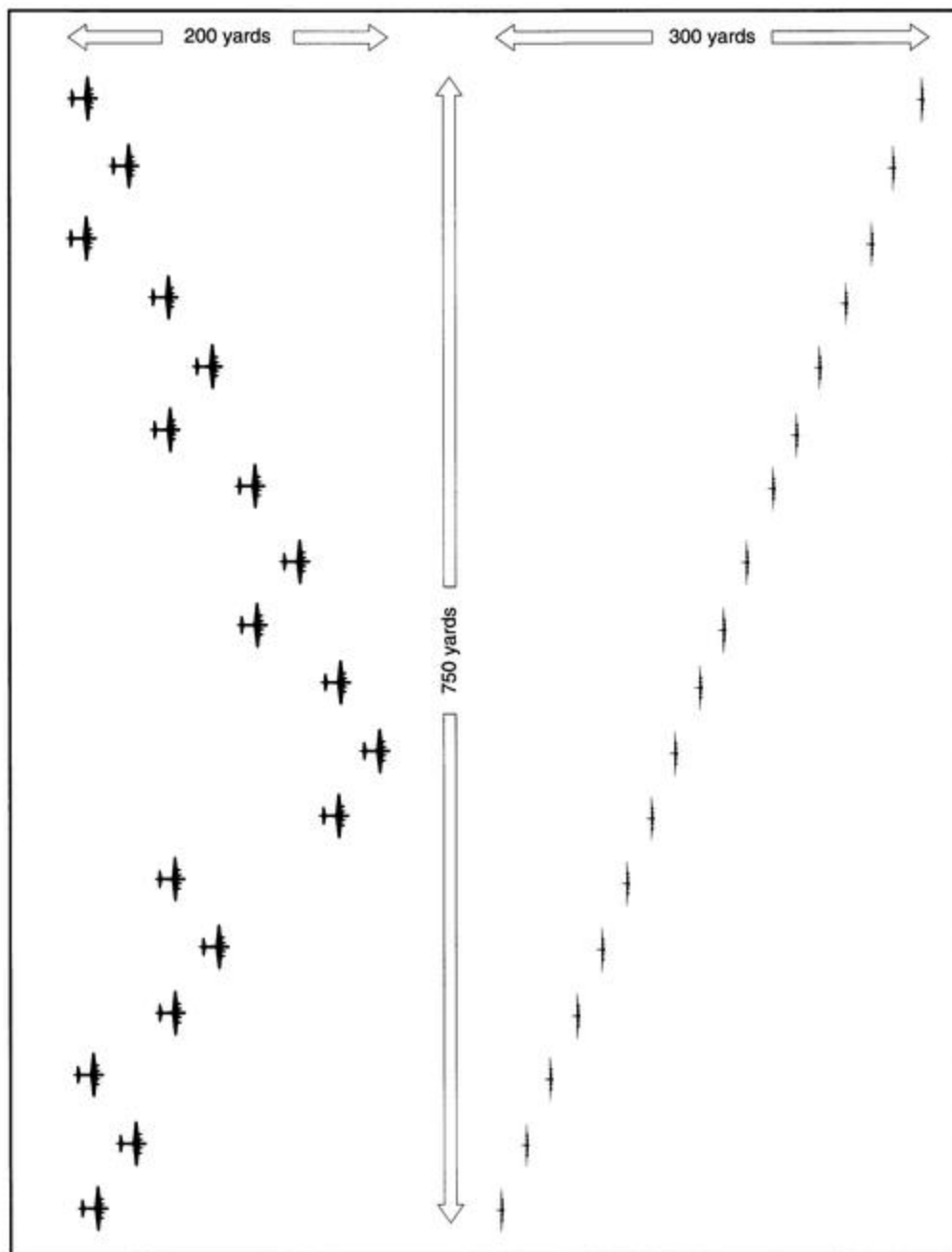

*The 18 aircraft Group introduced in December 1942. Three 6 bomber squadrons flew stacked towards the sun.*



difficulty for pilots of flying in formation. Distances were calculated so that a single flak burst between two planes could not damage both aircraft severely. However, it was soon realised that 6 spread out bombers would not be strong enough to repel German fighters. By September 1942 a new tactic was devised: two nine plane squadrons flying in 18 plane Groups. The second squadron flew 500 feet above and behind the first. This was a much tighter formation but very difficult to control in turns when the outside aircraft were prone to lose contact with the leader.

December 1942 saw the advent of three 6 plane squadrons making up the 18 aircraft Group with bombers stacked towards the sun and the lead squadron at the centre between a high and low squadron. This formation made good use of the defensive armaments of the B-17 bomber Group.

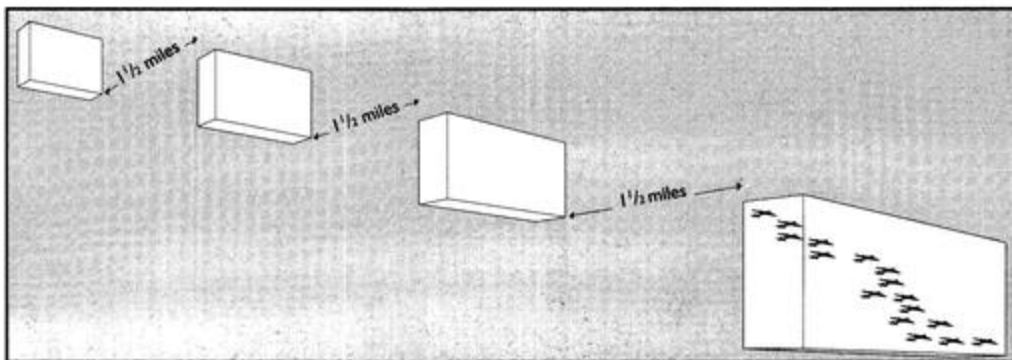

*A four Group 'Javelin' formation used from December 1942*

As the US 8th Air Force bomber fleet grew in size it adopted a 4 Bomber Group formation called 'Javelin', with each Group (18 planes) following the other at one and a half mile intervals stacked towards the sun. This made it difficult for enemy fighters to attack the rear most aircraft of the Group but it also meant that squadrons at the back had great difficulty keeping in formation.

February 1943 saw the introduction of the 'Wedge' formation: the centre Group led with the top and bottom Groups ranged in echelon in opposite directions. This 54 aircraft Combat Wing formation was 1.3 miles wide, and 0.3 miles from front to back. Although it allowed better supporting firepower between aircraft, squadrons and Groups, it was still difficult to maintain position in a turn.

In April 1943, the Combat Wing formations were made tighter with three aircraft Vees stacked in one direction and squadrons stacked in opposite directions. This 'Tucked-in' Wing formation, as it was called, gave more concentrated firepower between squadrons and planes.

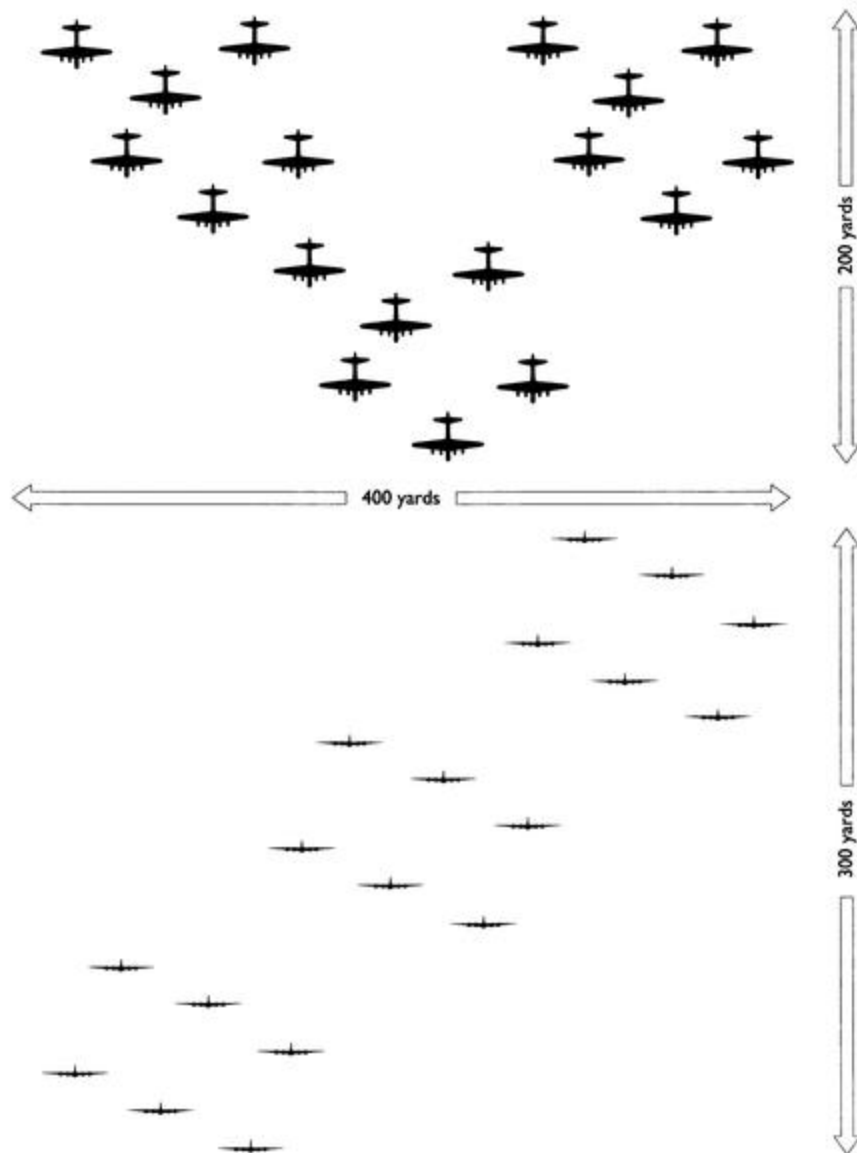

*Three aircraft Vees stacked in one direction with squadrons stacked in the opposite direction as part of the 'Tucked-in' Combat Wing formation introduced April 1943.*

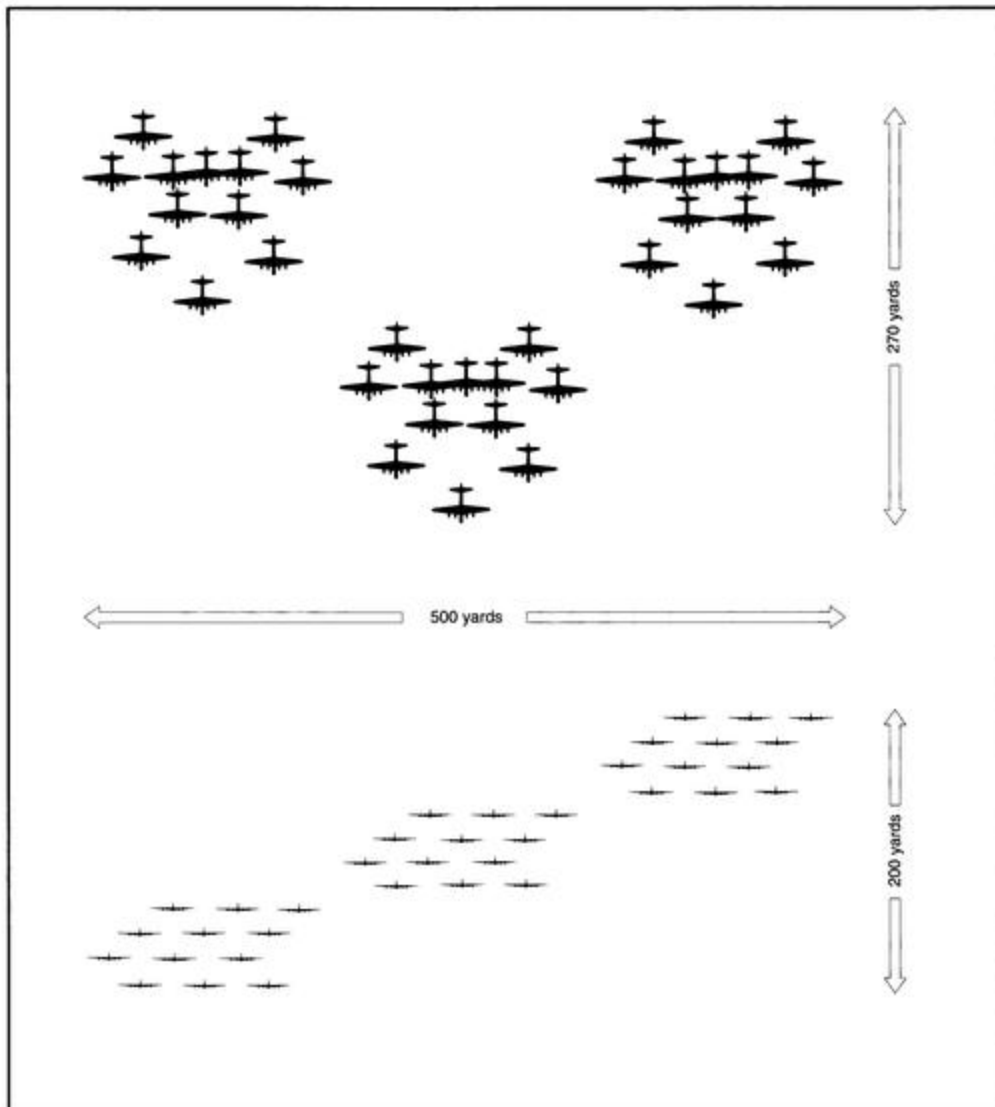

*January 1944 saw the development of the 36 aircraft Group formation with three 12 plane squadrons led by a target finding radar equipped bomber.*

By the end of 1943, with the development of long-range fighter escort and radar aids, the formation system was used much less for defensive firepower. 12 aircraft squadrons flew in 3 squadron Groups with each Group spread out at 4 mile intervals. This formation was used successfully until the end of the war.







**SPECIAL  
EASTER EGG  
FOR "HITLER"**

# Bombs

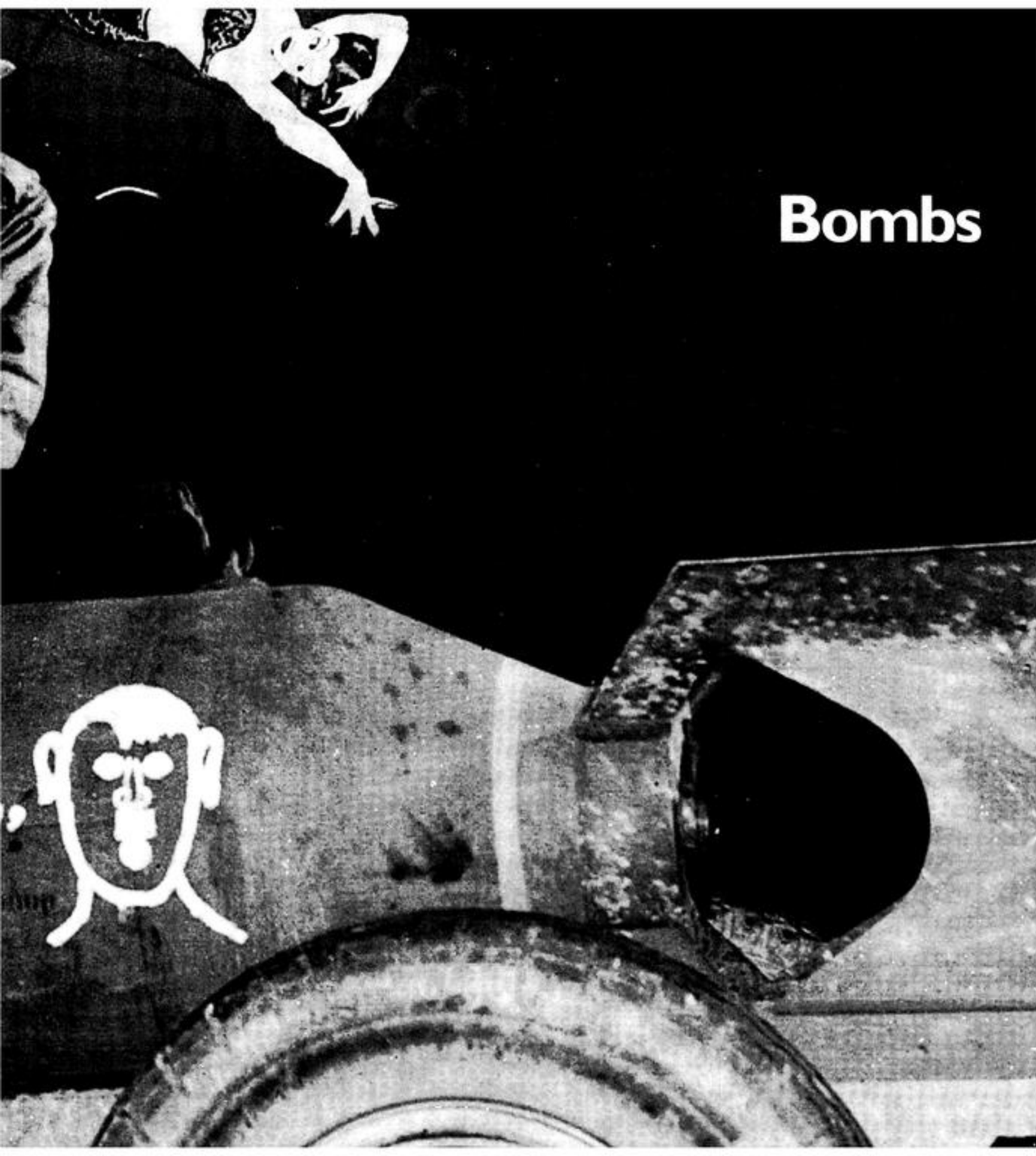



# BOMBS

## General Purpose/High Explosive Bombs

THE standard bombs used by 8th Bomber Command from September 1942 were the five General Purpose types: the M30 100lb, M31 300lb, M43 500lb, M44 1000lb and M34 2000lb. Generally, 500lb, 1000lb, and 2000lb bombs were carried for industrial targets and the others for airfields. The 8th Air Force used 1000lb and 2000lb bombs for attacks on submarine pens but these had little effect on the vast concrete fortifications that sheltered the U-boats most of the damage was done to the surrounding port area.

General Purpose (GP) bombs used in the early missions were fitted with quarter second delay tail fuses with an extra tenth of a second fuse in the nose. In a report, in December 1942, after the raid on Lille, it was calculated that 30% of the bombs dropped had failed to explode because the arming mechanisms had frozen up after being exposed to damp conditions on the airfields overnight. Standard Operating Procedure was soon changed so that fuses were installed just before take off. Eventually, to avoid accidents in handling, fuses were to be inserted only when the bombs were securely fixed into the aircraft.

In 1943, a new set of GP bombs were produced: the M57 250lb, M64 500lb, M65 1000lb and M66 2000lb. These accounted for most of the bombs dropped in the final year of the war. In January 1945, experts recommended 250lb GP bombs to be used against synthetic oil plants, ammunition dumps and oil storage facilities. The 100lb bomb was recommended for attacking railway yards and runways.

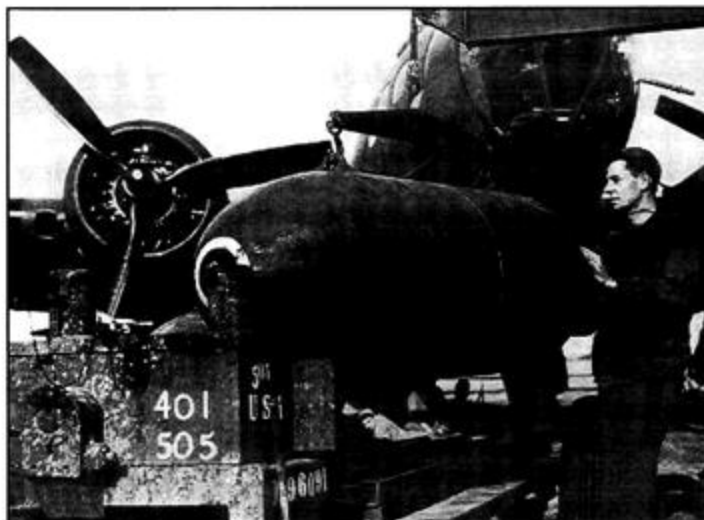

*Loading a big bomb from the trailer to a cradle prior to being fitted into the bomb bay of the B-17F.*



*A raid on Strasbourg from five miles in the air.*

## Incendiary Bombs

Originally, the only incendiary bombs available were the British 250lb and 500lb models filled with a rubber/gasoline mix, but in November 1942 the American M50A1 4lb magnesium bomb was added to the arsenal. It was packed in 100lb clusters which had a tendency to open prematurely, disperse too widely and cause damage to other planes in the formation. In January 1944, the US 8th Air Force used the 500lb M17 cluster which had better ballistics and a primercord release

that could be set to give correct disbursement. This became the most favoured and effective incendiary bomb among the bomber Groups.

High explosive and incendiary bombs fell through the air in varying trajectories and thus an accurate attack with a mixed load was very difficult to aim. For this reason, time-lag tables were used to indicate the release interval times of the different types of bomb. Eventually, factors such as wind speed and altitude were also taken into account.

## Napalm Bombs

In the latter half of 1944 a refined petroleum jelly called Napalm became available. Known as Class-C Fire Bombs and with a capacity of 108 US gallons, these bombs were only used in a few missions. A B-17 carried four such bombs with tiny igniter units fitted to each tank.

## Fragmentation Bombs

Used as anti-personnel bombs during ground force support attacks, these 20lb M41's were fitted in 120lb and 500lb clusters. They were very light bombs and the B-17 Norden bombsight had to be used with a special computation table to provide the maximum trail angle (distance between plane and point of impact).



## Poison Gas Bombs.

Poison gas bombs were kept in stock as a deterrent throughout the war by the US 8th Air Force. They consisted of two types, both made in Britain; the 400lb 'Flying Cow' mustard gas bomb and the 500lb phosgene bomb.

## VB-1 AZON Bomb

A basic 1000lb bomb but with a special tail attachment which allowed it to be steered over a distance of 200 feet to either side of the point of impact from a height of 20,000 feet. They were controlled by the dropping aircraft using an AN/ARW-9 transmitter. The bomb could only be attached to a B-24 on a 2000lb bomb shackle.



*The fifth raid on Lorient, on the French coast; the home of the German 750-ton U-Boat that could range all the way to the Caribbean. B-17's dropped bombs on Port Militaire where the servicing, dry dock and repair shops were located.*

## GB-1 Glide Bomb

This was made from a M34 2000lb bomb fixed to a 12 foot span glider unit and attached to a B-17 underwing shackle. Two Glide bombs could be carried per plane. Essentially free fall, the bomb had a stabilizing device that allowed control of direction. The bomb proved to be unreliable on the only occasion it was used on Cologne in April 1944.

## GB-4

A radio controlled bomb which had a TV camera fitted in the nose section that transmitted a TV signal over a range of 15 miles. It was only ever used on one plane, a B-17, on a single combat sortie.

## Disney Rocket Bomb

This 4500lb bomb was designed for penetrating the thick concrete U-boat shelters. It was free-fall until a rocket motor fired at 5,000 feet, pushing the missile to speeds of 2,400 feet per second upon impact. It could penetrate 20 feet in solid concrete before explosion and was first used by 92nd Group on 14th March 1945.





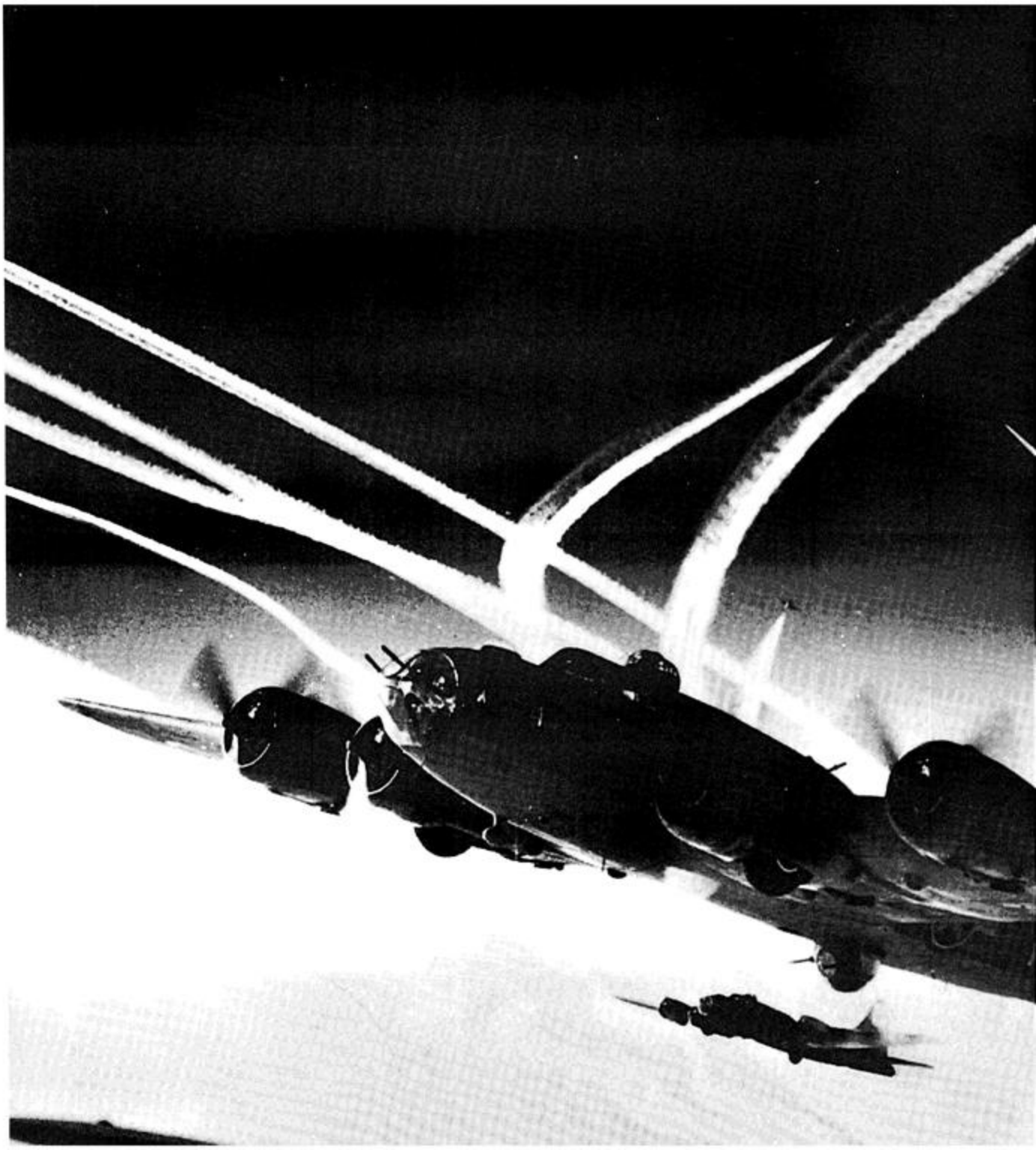

# The Fighter Escort





## THE FIGHTER ESCORT

THE job of the fighter escort squadrons was to give the heavy bombers maximum protection to and from their target. This meant that the escort planes had to be with the bombing force for as long as possible. Each fighter squadron had three or four flights stepped down behind the lead flight; so that all could keep an eye on the leader. Flights were kept 150 feet apart with individual aircraft from each flight keeping within 40 feet of each other.

As soon as they achieved formation, P-38 Lightnings and P-47 Thunderbolts immediately turned on their long distance drop tanks, while the P-51 Mustang had to use up about 30 gallons from its main tanks, to maintain balance, before turning to wing drop tanks.



*Fighter escort pilots of the 8th Air Force ride to an airfield clutching maps and bars of chocolate.*

Spurious fighter activity on the way to the target had to be avoided because, in the event of combat, long distance drop tanks had to be jettisoned and the bomber fleet subsequently abandoned. On rendezvous with the bombers, one fighter group, made up of three squadrons, was allocated to each Combat Wing box. One squadron divided and positioned itself ahead and above the

bombers, another squadron also split and took up position above and about a mile away on either side of the formation. The last squadron climbed 4000 feet directly above the force and ten miles into the sun in anticipation of the normal enemy fighter strategy of diving out of the sun's glare.

The escort fighters weaved or orbited so that they could stay in touch with the slower bombers with pilots constantly scanning the skies for 'bandits'. Although mirrors were fitted to cockpits, good fighter pilots were nicknamed 'swivel



heads' because they had to keep looking all around them at all times. The fighter pilots could communicate with the bombers and warn each other of attacks or respond to calls for fighter help. Up until 1944 the prime objective of the fighter force was to stay with the bombers, but after January 1944, with the lessening power of the Luftwaffe, they were allowed to pursue the enemy further afield.

The main combat tactics used by fighters of both sides were: using the sun's glare to achieve surprise in diving attacks, turning into an enemy, tightening a turn to get behind him, rolling away and diving to escape a dangerous situation. But, as in all things, the tactics depended upon the aircraft's performance capabilities.



*A formation of P47 Thunderbolts providing bomber escort over Germany. The P47 was the first fighter to provide long-range, high altitude protection for the B-17's equipped with drop tanks and eight powerful machine guns.*

The **P-47 Thunderbolt** was a heavyweight compared to the two most common German fighters: the Me 109 and the FW 190. At low altitude the German fighters could overtake, outclimb and out-turn it; but above 15,000 feet, in the realms of the B-17, the P-47 had better acceleration and diving performance. The P-47 had to keep its IAS above 200mph and ideally attack in a dive giving it momentum for a break-off climb, preferably into the sun. The eight 0.50 calibre guns it carried could do serious damage to an enemy aircraft. At

the beginning of 1944, the P-47 was modified to perform equally well at low altitude.

The **P-38 Lightnings** experienced difficulties at high altitude, including many engine failures. Thus, in the early part of the bomber war they were restricted to a ceiling of 20,000 feet. It was not until the summer of 1944 that developments helped overcome that limitation. The P-38 was a large, twin-engined and very manoeuvrable aircraft that could make fast turns by varying the speed of each



engine. In general, escort tactics were to stay high above the bombers and intercept enemy fighters with darting, shallow dives.

The **P-51 Mustang** powered by the powerful Merlin engine, was superior to most of the other fighter models in performance. Although possessing light armaments, the P-51 was more flexible than the other two escort fighters and gave pilots greater confidence in engaging the enemy. At high altitude, the aircraft had a good top speed and superior diving speed, allowing quick attack and escape. Successful fighter escort pilots avoided dog-fighting at all costs and concentrated on hit and run techniques for which the P-51 was well suited. This

method of attack is thought to have accounted for 75% of fighter aircraft successes throughout the war.



*A P-51 Mustang squadron of the 361st Fighter Group high above the bomber formation. Drop tanks under each wing were jettisoned when empty or when in combat.*

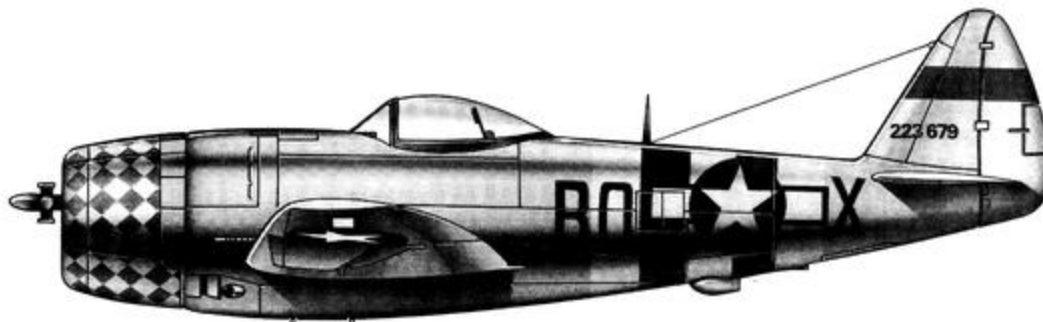

## THE REPUBLIC P-47 THUNDERBOLT

Models:	P-47B, C, D, M, N
Built by:	Republic Aviation Corporation
Aircraft type:	Fighter/Fighter-bomber; Single seater
Engine:	Pratt & Whitney R-2800 Double-Wasp 18 cylinder two-row radial
Dimensions:	Span 12.4m; Length 11.03m.
Performance:	<i>Speed:</i> B- 412mph; C- 433mph; D- 428mph; M- 470mph; N- 467mph. <i>Service ceiling:</i> 38,000 feet (B) to 43,000 feet (C, D, M, N) <i>Operational Range:</i> 575 miles (B); 1000 miles (C); 1,900 miles (D with drop tanks); 2,350 miles (N).

Designed by Republic's chief designer Alexander Kartveli after studying the air combat that was taking place in Europe at the time. The P-47B went into production in early 1942 and joined the 8th Air Force in Britain for escort duties for B-17 and B-24 raids. Once the aircraft was fitted with extra fuel drop tanks, it could fly all the way to the target. Vast numbers of P-47D's were built (12,602), the largest of any sub-type of fighter in history.



A quartet of top-scoring Thunderbolt pilots of the US 8th Air Force.



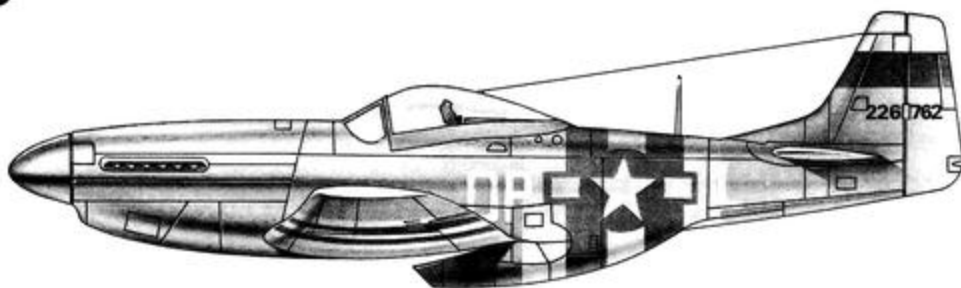

## **NORTH AMERICAN NA-73 P-51/A-36 MUSTANG**

Models:	P-51 to P-51L
Built by:	North American Aviation, Dallas and Inglewood.
Aircraft type:	Fighter/Single seater
Engine (B, C, D, K):	Packard V-1650 (licence built R-R Merlin 61 series).
Dimensions:	Span 11.29m; Length 9.81m
Performance:	<i>Speed:</i> 437mph (P-51D) <i>Service Ceiling:</i> 41,900 feet <i>Operational Range:</i> 1,300 miles (with drop tanks).

Originally a commission by the RAF to North American Aviation for the design and development of a completely new fighter, the P-51 was designed, built and flown within 117 days. The RAF got 620 Mustangs and in 1942 the superior airframe was matched by the excellent Merlin engine producing the P-51B, the Mustang III (C), and the teardrop canopy D model with six 0.50-calibre guns. In all, 15,586 Mustangs were built; their main task being to fly from England with the 8th Air Force deep into Germany escorting heavy formations of daylight raiders.

*A Mustang fighter pilot stretches his legs after a long and arduous bomber escort mission deep into Germany.*





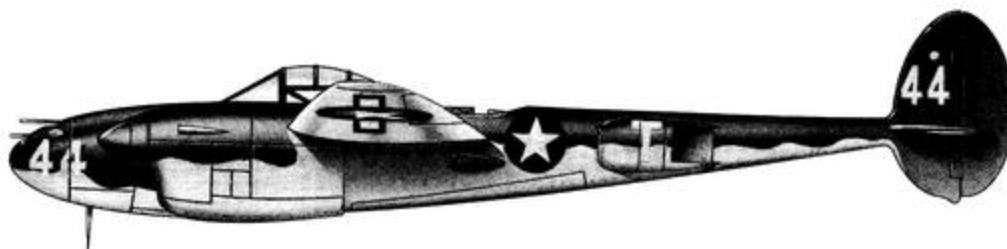

## P-38 LIGHTNING

Models:	XP38 to P-38M
Built by:	Lockheed Aircraft Corporation
Aircraft type:	Long-range fighter/bomber/Single seater
Engine:	Two Allison V-1710 vee-12 liquid cooled.
Dimensions:	Span 15.86m; Length 11.53m
Performance:	<i>Speed:</i> 391-414mph
	<i>Service Ceiling:</i> 38,000-40,000 feet
	<i>Operational Range:</i> 360-460 miles

Built by Lockheed, a company not known for its military aircraft at the time, using a new concept in design, it brought in startling figures for performance in 1939. After the US entered the war, the P-38 was always found deep in combat in Europe, North Africa and the Pacific. The F model was the first to have the capability to carry 1000lb bombs, torpedoes, drop tanks and other stores using inner-wing pylons.

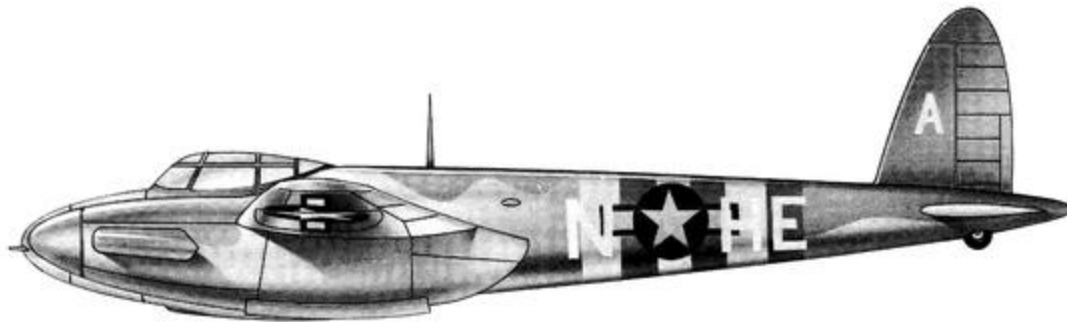

## DE HAVILLAND 98 MOSQUITO

Models:	D.H.98 1 to 43
Built by:	The de Havilland Aircraft Company
Aircraft type:	High speed bomber/many variants
Engine:	Two Rolls-Royce Merlins
Dimensions:	Span 16.5m; Length 12.34m
Performance:	<i>Speed:</i> 300-425mph <i>Service Ceiling:</i> 30,000 to 44,000 feet <i>Operational Range:</i> 1,860 miles

Made of wood, in order to save much needed metal, the Mosquito was originally designed as a fast, unarmed day bomber. Grudgingly approved by the British Air Ministry, its role was seen as a basic reconnaissance craft. Eventually nearly 8,000 were built performing a wide variety of tasks including nightfighter, trainer, bomber, fighter-bomber and high altitude fighter.

# GERMAN FIGHTERS

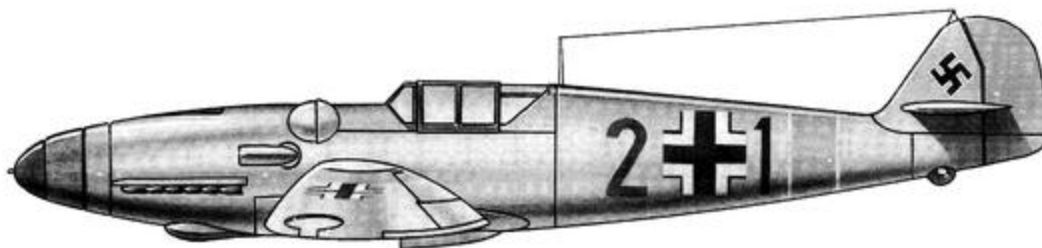

## ME 109

Models:	Bf 109G-6; Bf 109G-10
Built by:	Messerschmitt
Aircraft type:	Single Seater Fighter
Engine :	Daimler Benz DB-605A 12 cylinder liquid cooled (G-6); Daimler Benz DB-605A 12 cylinder liquid cooled (G-10).
Dimensions:	Span 32.5 feet ; Length 29.5 feet
Performance:	<i>Speed:</i> 340-386mph (G-6); 342-426mph (G-10) <i>Service Ceiling:</i> 37,890 feet <i>Operational Range:</i> 620 miles (with drop tanks)

An exceptional fighter at the beginning of the war but kept in service too long and eventually easily overtaken by the Spitfire and the Fw 190 in performance. 35,000 Me 109's were built including later models fitted with a supercharger to ensure a higher service ceiling. The 109 was an adaptable fighter that could be fitted with different guns, bomb racks and fuel tanks. The G-6 was usually fitted with an MG 151 cannon, which was very useful against Allied bombers but made the plane heavy when manoeuvring against Mustangs and Thunderbolts. The new model G-10 appeared in 1944, was very fast and had a much bigger supercharger.

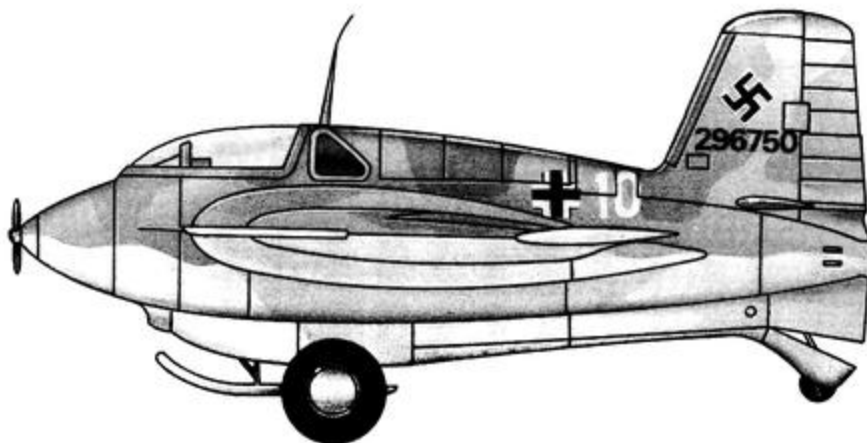

### **ME 163**

Models:	Me 163B-1a Komet
Built by:	Messerschmitt
Aircraft type:	Single Seater Fighter
Engine:	Walther HWK 509A-1/ A-2 bi-fuel Rocket
Dimensions:	Span 30.5 feet ; Length 18.5 feet
Performance:	<i>Speed:</i> 515-596mph (Sea level-20,000 feet) <i>Service Ceiling:</i> 39,500 feet <i>Operational Range:</i> 50 miles

The rocket powered Komet was the most startling addition to German aircraft design. It had a short fuselage and discarded its landing gear once airborne. Capable of phenomenal climbing ability it could only function for just over 9 minutes and, although it could get among the US bomber formations very easily, it effectively only gave the Komet pilots 3 or 4 seconds to aim and fire the two MK 108 cannons. After all of its fuel was used up, the Me 163 had to glide back to base but would then be at its most vulnerable against the bomber fighter escorts. Another major disadvantage was the explosive nature of its two rocket fuel elements, called "T-Stoff" and "C-Stoff". These exploded violently, if they came into contact with each other. Sometimes the Komet would explode if its glide landing was rough and there were traces of the volatile fuel left in the tanks.

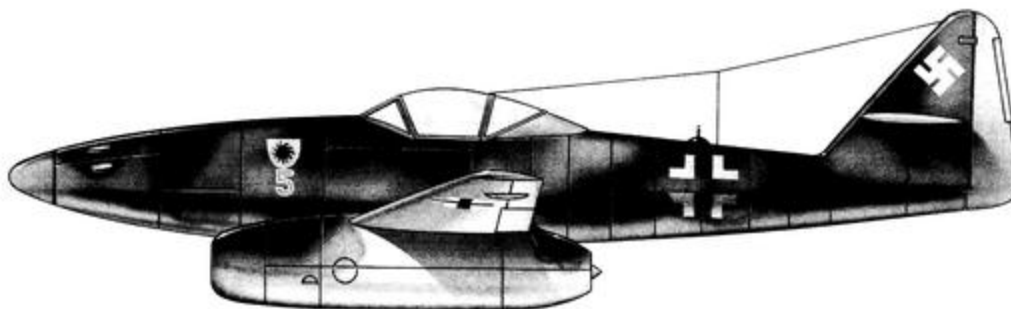

## ME 262

Models:	262A-1a, 262A-2a
Built by:	Messerschmitt
Aircraft type:	Single Seater Fighter
Engine:	Two Junkers Jumo 004B-1/ B-4 Turbojets
Dimensions:	Span 12.5m; Length 10.6m
Performance:	<i>Speed:</i> 515mph (sea level) - 540mph (20,000 feet) <i>Service Ceiling:</i> 39,360 feet <i>Operational Range:</i> 652 miles

The first combat jet aircraft to be actively used in WW2, the Me 262 was faster than anything the Allies could put into the sky in 1944. It could rip through bomber formations and turn well at high speed, out-performing any pursuing escort plane. However, its development and widespread use was stifled by the lack of competent pilots, the scarcity of fuel, and German failure to recognize its full combat potential at an early stage. When it did appear, in October 1944 it was a stunning success. Heavy bomber gunners did not have time to aim, let alone fire, and even the fastest fighter was left behind. Even the Me 262 pilots were unused to combat at such high speeds and often chose to slow down for the actual attack and it was then that they were most vulnerable to conventional bomber defences.

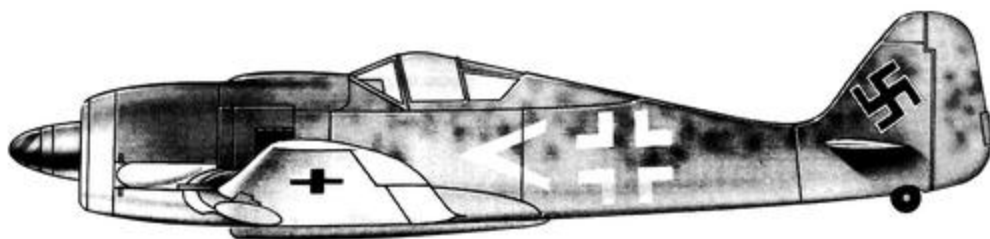

## **FW 190**

Models:	190A, 190D
Built by:	Focke-Wulf Flugzeugbau
Aircraft type:	Single Seater Fighter
Engine:	BMW 801 (A); Jumo 213 (D)
Dimensions:	Span 10.5m; Length 8.84m
Performance:	<i>Speed:</i> 355mph (sea level) to 408mph (20,600 feet) A; 355mph (sea level) to 453mph (20,600 feet) D <i>Service Ceiling:</i> 34,500 to 37,500 feet <i>Operational Range:</i> 500 miles

A matchless design and the most effective German piston-engined fighter. The Luftwaffe pilots preferred the Fw 190 to the Me 109 because it was smaller, lighter, more manoeuvrable and extremely adaptable. It could perform equally well as a dive bomber, a fighter bomber or a night fighter.







# Bomber Recognition

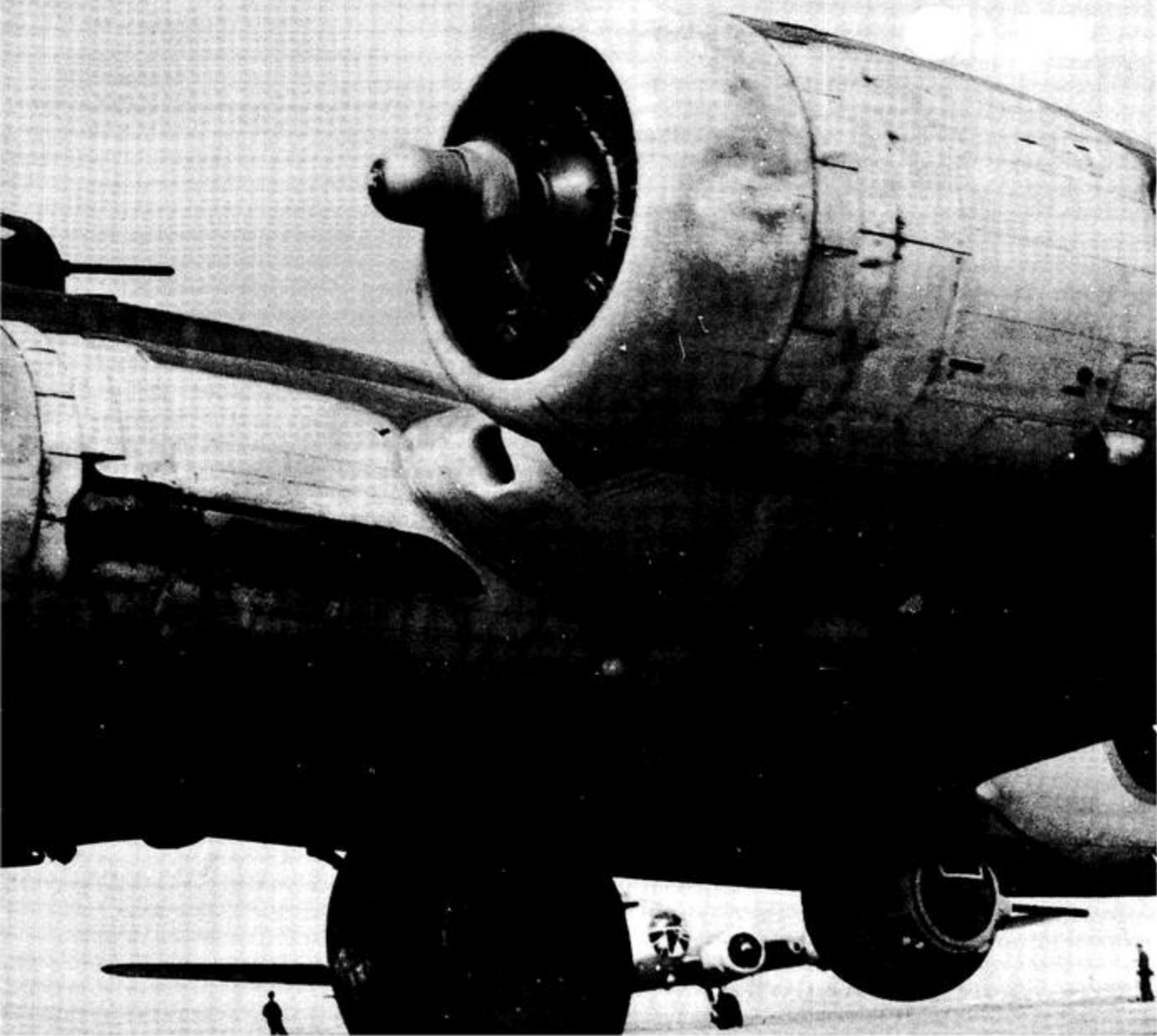

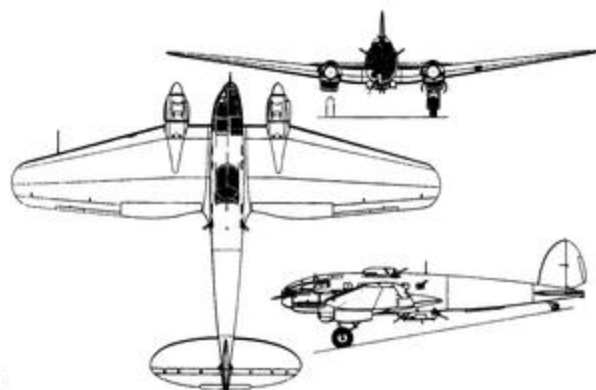

**HEINKEL HE 111**

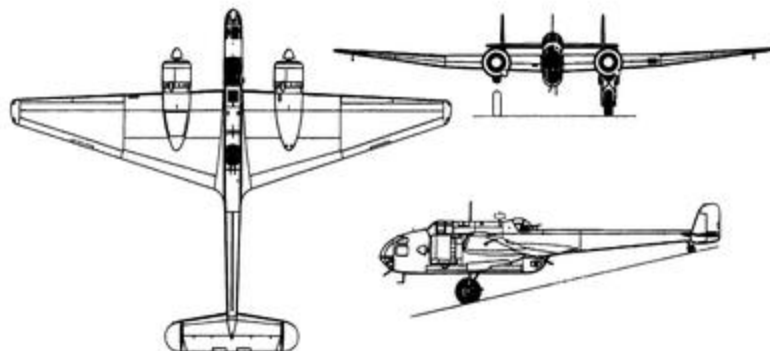

**HANDLEY  
PAGE HAMPDEN**

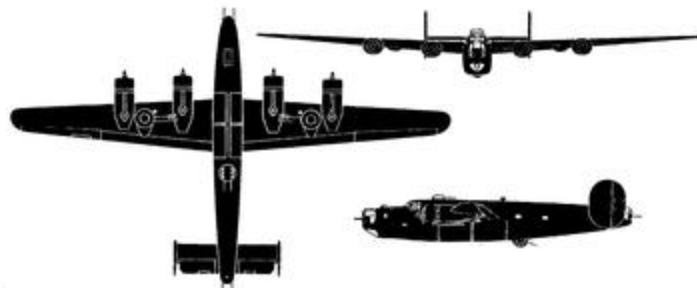

**CONSOLIDATED  
B-24 LIBERATOR**

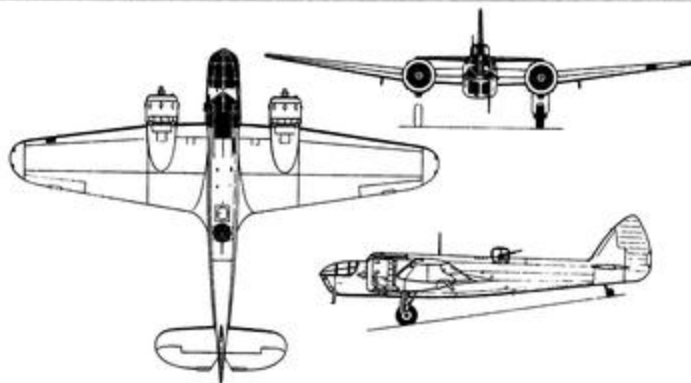

**BRISTOL TYPE 142  
BLENHEIM**

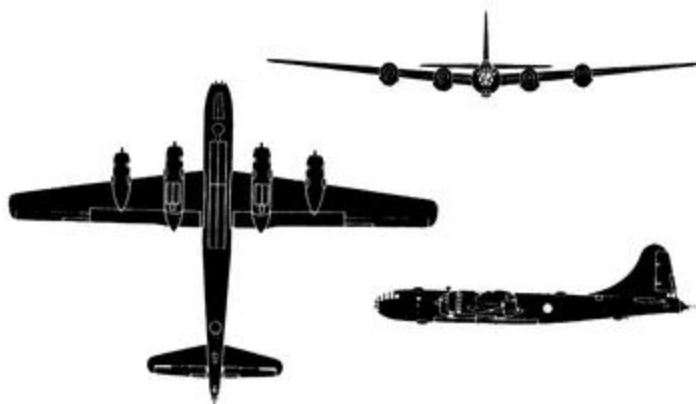

**BOEING B-29  
SUPERFORTRESS**

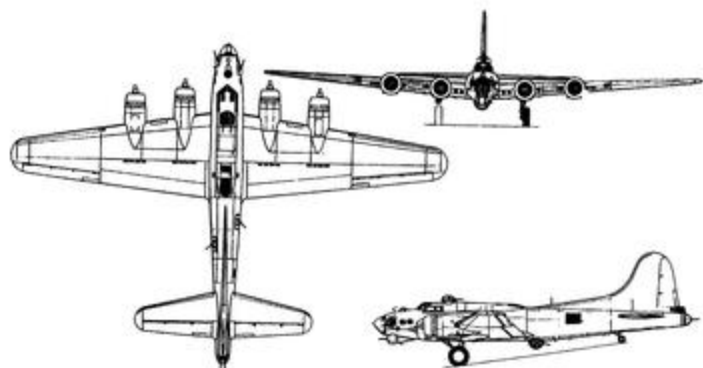

**BOEING B-17  
FORTRESS**

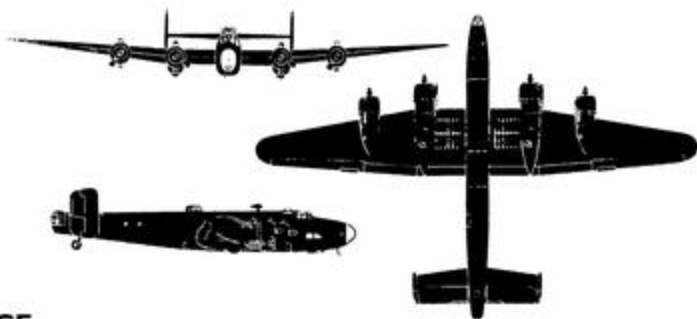

**HANDLEY PAGE  
HALIFAX**

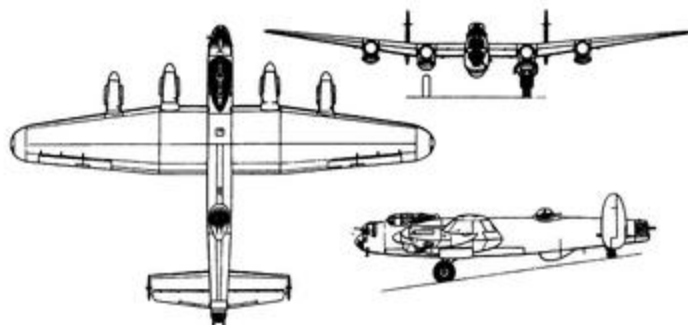

**AVRO 683 LANCASTER**

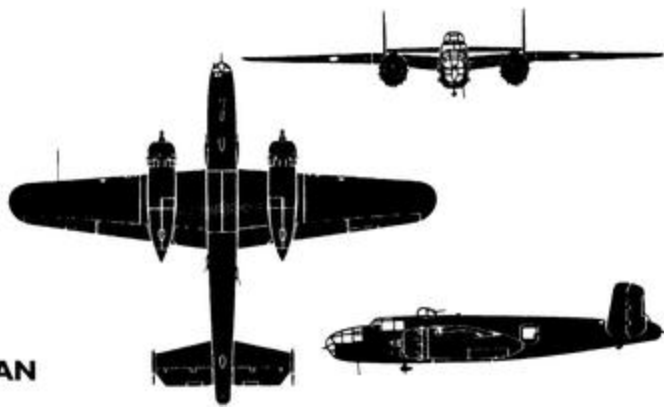

**NORTH AMERICAN  
B-25 MITCHELL**

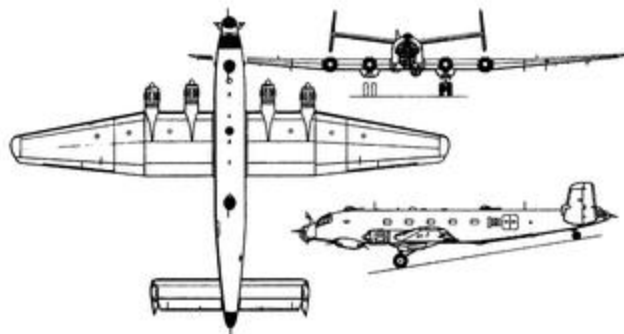

**JUNKERS JU 290**

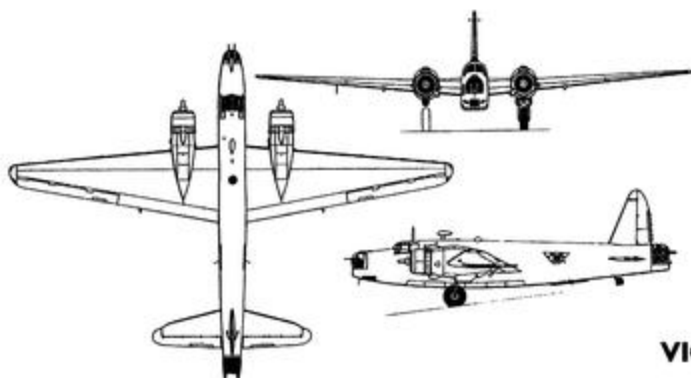

**VICKERS-ARMSTRONGS  
WELLINGTON**

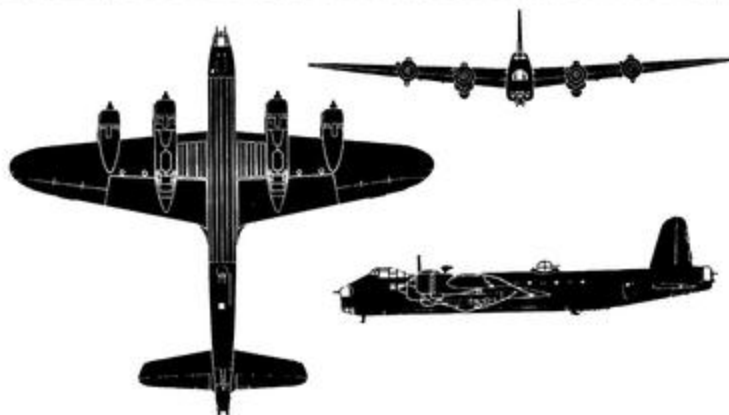

**SHORT S.29  
STIRLING**







## GLOSSARY

- Aileron-** Lateral control flaps at rear of airplane main wing tips. Raised and lowered by the control column will make the plane turn to the left or the right.
- Aphrodite Project-** Obsolete B-17F/G's stripped of war equipment fitted with radio sets, linked to the autopilot and loaded with ten tons of explosive. Guided by a 'mother' aircraft to the target.
- Area Bombing -** The bombing of 'general' targets and destruction of square acres of industrial towns as opposed to specific strategic targets. Advocated by Air Marshal 'Bomber' Harris Chief of RAF Bomber Command and still a matter of controversy today.
- Autopilot-** An electro-mechanical robot which controls the plane automatically in straight and level flight, or manoeuvres the craft in response to the fingertip controls of the pilot or bombardier.
- Bomb Ballistics-** The air resistance of the bomb calculated by its shape, size and weight.
- Buncher Signal-** (Also **Splasher**) A signal emitted by a radio beacon in Morse code, around which a B17 Group would get into formation above the cloud layer.
- CCRC-** Combat Crew Replacement Centres
- CG-** Centre of Gravity. The centre of gravity was a major factor when loading the B-17 because it had such a heavy tail section. There were restrictions as to how many ammunition boxes could be stowed in the rear of the plane.



- Carpet-** A barrage radio jammer that transmitted a continuous signal on a wide range of pre-set frequencies.
- Carpetbagger Operations-** Patriot Support Operations named after opportunist visiting salesmen. Aimed primarily at resistance fighters in central and south-east France.
- Chaff-** (Also **Window** and **Rope**) Lengths of aluminium foil released in large numbers by bombers in order to create fake targets on German radar.
- Dead Reckoning-** The basis of all other types of navigation. The position of the plane was worked out by keeping record of track and distance flown over the earth's surface from the last defined point.
- Deflection-** The swerving path of a stream of bullets fired towards a target when affected by speed and gravity.
- Drag-** The wind resistance encountered by a fast moving object.
- Drift-** A bombing term. The distance the bomb will travel downwind from the point of release to the point of impact.
- Drop Tanks-** Extra fuel tanks developed to fit various B17 escort fighters and usually carried on the wings. Fighters would switch to drop tanks soon after take off, use up the extra fuel on the way to the target and then discard the empty tanks. In the event of air combat the drop tanks would have to be discarded to make the fighter battle worthy.
- Elevators-** The horizontal portions of the tail. When pushed down will make the plane dive or pitch down, when pushed up will make the plane climb.
- ETO-** The European Theater of Operations. The US term for the war in Europe.



<b>Feathering-</b>	To turn the propeller blades end-on to the direction of travel thus giving a zero drag value in the event of engine failure. A free spinning propeller made the bomber very difficult to control.
<b>Flak-</b>	German anti-aircraft fire. The main danger from an exploding shell were the high velocity splinters from the burst casing. If a heavy calibre shell exploded close to an aircraft it would cause devastating damage.
<b>Flak Vest/Suit-</b>	Lightweight body armour originally made by the Wilkinson Sword Company. It was discovered that two-thirds of men hit by flak shrapnel in bomber combat escaped serious injury because they were wearing flak vests.
<b>Flaps-</b>	The large sections on the trailing edge of the wings that enable the aircraft to get extra lift at takeoff and slow down for a landing
<b>Frank Suit-</b>	The British pressurized suit worn to prevent 'blackout' when affected by G-forces. Worn by some fighter pilots from April 1944 onwards.
<b>G-Suits-</b>	The US version of the Frank suit (see above).
<b>Groundspeed-</b>	The speed of the aircraft relative to the earth's surface. A navigation term.
<b>IAS-</b>	Indicated Airspeed on the pilot's control panel.
<b>IFF-</b>	Identification friend or foe signal beamed out by bombers passing over home defenses.
<b>IP/Initial Point-</b>	The point where the bombing Group turn towards the target in preparation for making the bombing run.



<b>Javelin-</b>	A bomber formation used by the 8th Air Force: each Group following the other at one and a half mile intervals stacked towards the sun.
<b>MAC-</b>	Mean Aerodynamic Chord. A formula for calculating the centre of gravity for an aircraft.
<b>Mae West-</b>	An inflatable life preserver. An RAF originated term comparing the wearer to the well-endowed film actress.
<b>MPI-</b>	Mean Point of Impact. The ideal pattern for bombs hitting a target as specified in the mission Field Order.
<b>MTU-</b>	Mobile Training Units.
<b>Naxos-</b>	A German nightfighter radar aid that homed in on H2S bomber target finding emissions and helped them locate the bomber formations.
<b>Nickels-</b>	Code name for leaflets dropped from B-17's in night time missions.
<b>Norden-</b>	A bombsight that worked on the tachometric system. A bomb aimer could 'fly' the aircraft by fine adjustment of the sighting telescope.
<b>PDI-</b>	Pilots Directional Indicator. A pilot's control panel dial that linked him with the autopilot and allowed him to respond to directional changes required by the bombardier.
<b>PFF-</b>	The Pathfinder Force. Established to mark the targets with flares or smoke before the main attack formation arrived.
<b>Purple Heart Corner-</b>	The lowest, rearmost and most exposed flight in a heavy bomber formation, often selected for head-on attack by enemy bombers.



<b>Rally Point-</b>	The re-assembly point after a bombing run. Ideally, in a position with no flak defences so that the Groups could get back into formation for the return to base.
<b>Rope-</b>	See Chaff
<b>Ruhr-</b>	The industrial heartland of Germany and the most heavily defended in Germany. Many bombing missions had targets within this area.
<b>SOP-</b>	Standard Operational Procedure
<b>Splasher-</b>	See Buncher
<b>Squadron-</b>	(Or Flight), Originally six aircraft in two Vees made up a squadron but, when there were more bombers available for operations, this was changed to three Vees in a nine aircraft squadrons.
<b>Stalag Luft-</b>	German prisoner of war camp for Allied airmen.
<b>Swivel-Heads-</b>	A popular name for fighter escort pilots who had to keep turning their heads around to check on enemy fighters appearing out of the sun's glare.
<b>Tokyo Tanks-</b>	Extra fuel tanks built into the wings of the B17F and G models increasing the range of the bombers; supposedly allowing them to bomb Tokyo from a carrier. They were made of rubber self-sealing cells.
<b>Tracer-</b>	Bullets fired from the Browning machine guns that radiated heat and light and allowed gunners to see where their bullets were striking. In 1944, a brighter form of tracer was introduced called 'headlight'. Tracer rounds were usually interspersed with other types of bullet at a ratio of one to four.
<b>Trail (bombing)-</b>	The horizontal distance between the bomber and the point of impact of the bomb on the ground.



- Trail (formation)-** Flying in line, one after the other.
- Trimming-** Good trim was essential for a heavy bomber. Poor trim cuts down airspeed, increases fuel consumption. Formation flying was extremely difficult without proper trimming.
- Turbo-Supercharger-** Each engine on a B17 had a turbo-supercharger that boosted manifold pressure for take off and allowed sea-level air pressure at high altitude.
- United Nations-** A term used early in the war for the Allies.
- Vees/Vics-** The basic three plane formation that was the building block of all other formations for heavy bombing.
- Wedge-** A US 8th Air Force bomber formation: the centre Group led and the top and bottom Groups were ranged in echelon in opposite directions.
- Window-** See Chaff
- X-Geraet-** German target finding system in which four beams, an approach beam and three intersecting beams automatically released the bombs at the correct bombing point.
- Zone System-** A machine gun firing system adopted by the US 8th Air Force. Gunners filled a zone with bullets and waited for the attacking aircraft to fly through it.
- YB-40-** An extra fortified Flying Fortress with sixteen 0.50-calibre guns, carrying 15,000 rounds of ammo but no bombs. Its task was to take on the enemy fighters before the main formation arrived. The YB-40 experiment failed as these models proved to be very slow and more of a liability than a help.



# DESIGNER'S NOTES

## THE GAME

*Flying Fortress* grew out of a fairly casual conversation with Paul Hibbard, the head of MicroProse's UK development team. What was wanted, he explained, was a 'different' flight simulator. At the time, I don't think either of us appreciated exactly how different...

There are — and always will be — plenty of 'standard' flight simulators available. These are the games that put you squarely in the pilot's seat — which is the only seat in the aeroplane. And in most flight simulators it's largely a game of you versus the 'Rest of the World'. There are even a few games around that allow you to fly multi-crew aircraft, but in most cases, there's nobody else on board — gun positions can be set to automatic fire, but that's about all...

But in *Flying Fortress*, you're not on your own! There are ten men on board, all doing important jobs at the same time. The earliest decisions about the game design were all to do with how the crew would be represented (as 'mini-personalities') and how they would behave. As work on the design progressed, we came to realise that giving orders to the crew was as least as important as flying the aircraft. As you play, you'll need to move people around inside the bomber, to carry out repairs, man the guns and help with the wounded. Perhaps *crew simulator* is a better term than flight simulator... Certainly, once you are in formation and heading for the target you need not — if you really want to run the risk — touch the flight controls again!

At the same time, we also wanted you to have the chance to jump in and take over from any of the crew, otherwise you could end up feeling like a spectator rather than a player. All the computer-controlled crewmen can do their jobs, but you'll find that to do well in the game, you'll have to master the skills of pilot, bombardier and gunner. Although I don't generally like talking about 'hidden' parts of the game design, the scoring system allocates more points to the player who gets 'stuck in' rather than letting the computer do the hard work.

The 3D technology in *Flying Fortress* also deserves a special mention here. The system does more than just give you attractive models of the aircraft in the game. All the aircraft are *articulated* models: as well as propeller movement, you can see gun turrets tracking round and undercarriages unfolding properly. The 3D models are among the best looking and most attractive yet seen in a flight simulator.





You may find it surprising you don't get to plan the bombing campaign and choose your targets. I have reasons for not including this kind of decision making the game. Most importantly, I felt that it was a diffusion of the emphasis in the game. *Flying Fortress* is about the aircraft and the men who flew them, not about the generals who organised the campaign.

As an aside, there is evidence to suggest that the Bomber Generals didn't do a very good job, even though the pilots and crews of the B-17's did everything — and more — that was asked of them. Tank and U-boat production, to take two examples, reached their highest levels during the early months of 1945, at precisely the times that the Generals were proclaiming their successes. For some historians, the real victory of the bomber offensive was the total destruction of the Luftwaffe as a viable force in the West. This enabled the D-Day landings to take place with complete Allied air superiority. The other victory of the campaign was in tying down men and resources in a 'Second Front' above Germany before the invasion.

## THE PEOPLE

*B17 Flying Fortress* is my first computer game design and, naturally, there is an even-longer-than-usual list of people who deserve thanks for their ideas, help and encouragement.

At MicroProse in Tetbury, Gloucestershire, thanks go to Paul Hibbard, for the idea of a 'proper' bomber simulator in the first place; Pete Moreland, the fount of all knowledge, for his useful comments; Alkis Alkiviades, for all the work he put in on the manual; and last, but by no means least, Tim Roberts for his support and managerial expertise. In the Leeds, Yorkshire, office Andy Craven, Mark Griffiths and Dominic Robinson all had a say in the design and must share any credit (but none of the blame for my mistakes!). Dean Betten and Derek Austin and Mark Griffiths (again) deserve credit for the superb art and 3D game world.

Mike Brunton

MicroProse

April 1992





**MICRO PROSE™**  
SIMULATION · SOFTWARE

**Microprose Ltd. Unit 1 Hampton Road Industrial Estate, Tetbury, Glos.  
GL8 8LD. UK. Tel 0666 504 326  
MADE IN THE UK**



**This was brought to you**

**from the archives of**

**<http://retro-commodore.eu>**