

SPACE QUEST 1

HINTBOOK

ROGUE WILCO

IN THE
SARIEN ENCOUNTER



 SIERRA



89 23 91

SPACE QUEST 1

HINTBOOK

ROGER WILCO

IN THE
SARIEN ENCOUNTER

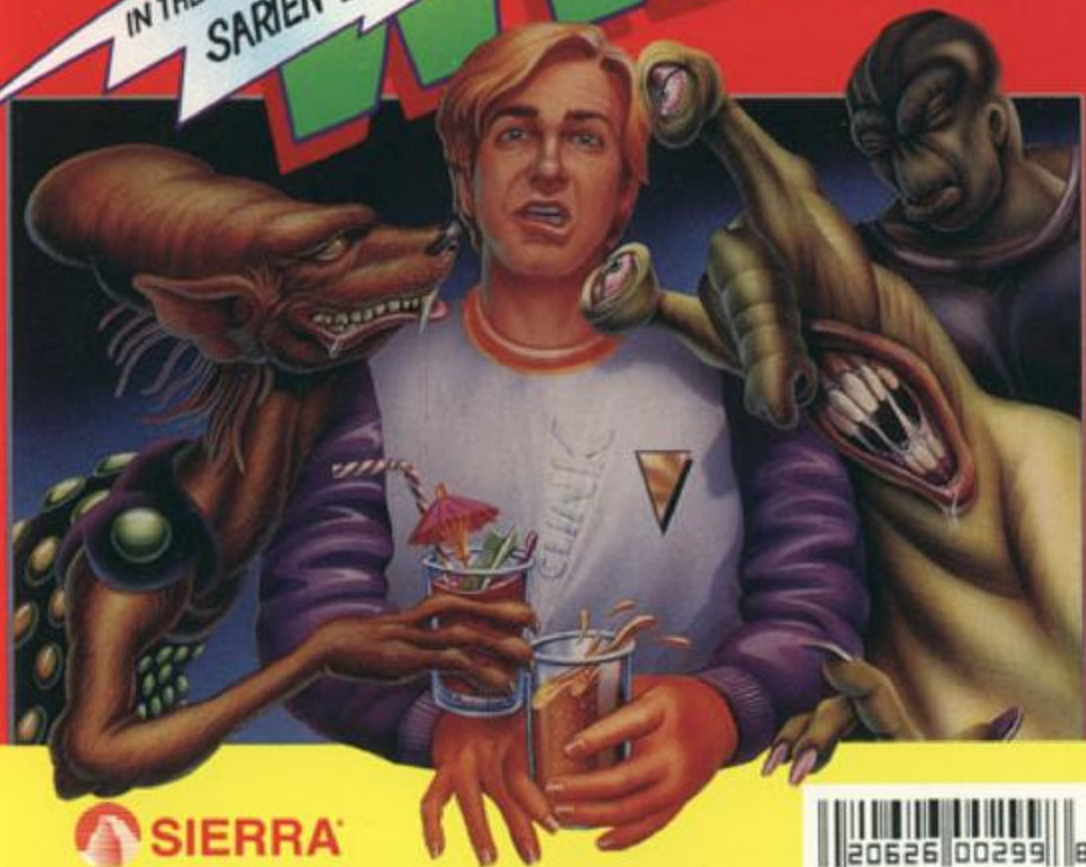

SIERRA ON-LINE, INC. • COARSEGOLD, CA 93614 • (209) 683-8989

TM designates trademark of Sierra On-Line, Inc. ® is a registered trademark of Sierra On-Line, Inc.
© 1991 Sierra On-Line, Inc. Printed in U.S.A.

002991800



89 23 91

This hint book has been specially created for the new icon-driven *Space Quest 1: The Sarien Encounter*.

All clues are written with this new interface in mind. People playing the original parser-driven *Space Quest 1* will have to type their answers to execute all the actions described in this book.

SPACE QUEST 1

ROGER WILCO™

IN THE
SARIEN ENCOUNTER

 SIERRA®



Table of Contents

About the Game.....4
 How to Use This Book.....4
 Note to Beginning Adventurers.....6
 My Exploits as a Space Hero.....6
 Getting Around in the Game.....8

Game Hints

Aboard the Arcada.....16
 The Burning Desert.....20
 Kerona - Underground.....23
 Ulence Flats.....26
 The Spaceship Deltaur.....30

Maps

The Spaceship Arcada.....35
 The Planet Kerona.....36
 Ulence Flats.....37
 The Spaceship Deltaur.....38
 Objects in Space Quest I.....42
 Points List.....43
 Game Credits.....46
 Hint Book Order Form.....47

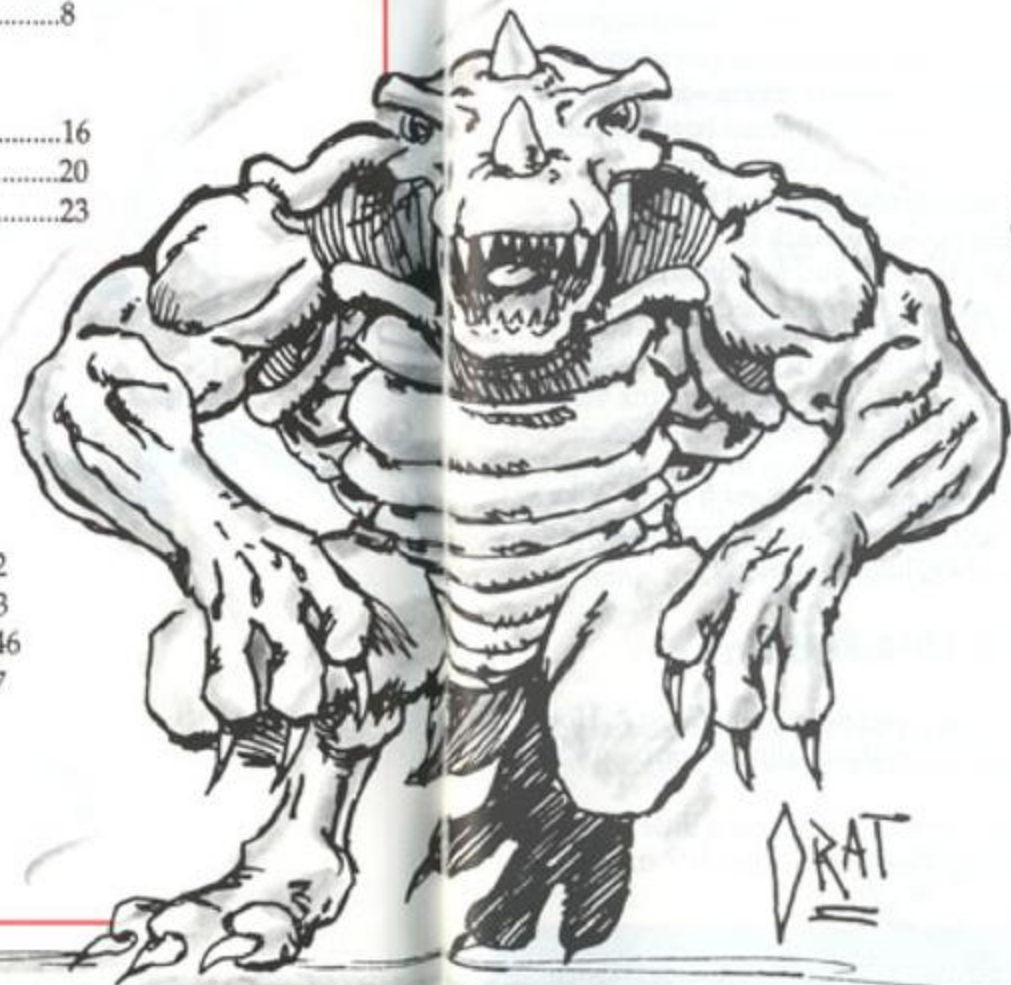

About the Game

This is your life, Roger Wilco. As the chief (and only) sanitation engineer aboard the Xenon research vessel Arcada, the pressing duties and ponderous responsibilities of your job can be overwhelming. Burning questions such as: "Should I dust or vacuum first?" take their toll on your intellectual and emotional strength. It is on just such a decision-filled day that, finding yourself in need of rest, you seek out the relative peace and quiet of the ship's broom closet.

But fate has other plans for you, Roger Wilco—the Sariens, acting on commands from the nefarious Sludge Vohaul, have captured the ship and stolen the super-secret research project, the Star Generator. Used responsibly, this powerful machine can change an otherwise lifeless planet into a raging ball of flame. It could then replace the ancient, dying sun of the Earnon solar system, of which your home planet, Xenon is a part. In the wrong hands, however, it is the ultimate weapon of destruction.

Now it's up to you to escape your doomed ship and find the Star Generator before the Sariens can turn its power to death and destruction, including the destruction of your home planet. If you fail, death will be your only reward, but if you succeed, you will be renowned as the Hero of Xenon.

About this Hint Book

Think of this book as your complete guide to *Space Quest I: Roger Wilco in the Sarien Encounter*. It's designed to help you out of tough spots and lead you into game areas you might not have explored thoroughly.

How to Use this Book

This book contains every answer to every puzzle in *Space Quest I*. How you go about using it can be very important to the quality of your gaming experience.

The answers to the hint questions are arranged to reveal a little bit of each puzzle solution each time you uncover one. The starred(*) answer is a

sequence of steps to accomplishing the needed tasks and should only be read if you do not understand how to go about solving the puzzle after reading all the other answers.

Example:

I'm in the kitchen, and I need to make a bologna sandwich. What should I do now?

- You'll need bread, bologna, cheese, mayonnaise and a knife.
- Most of this stuff can be found in the cupboard.
- Most of the rest is in the refrigerator.
- The knife is in the drawer.
- * Take out two slices of bread and spread them with condiments.

Place the meat and cheese on one piece and cover with the second piece, being sure to face the mayonnaise side down. It would be helpful to have a plate and a napkin handy, too.

You get the idea, right?

The 'Right' Way vs The 'Wrong' Way to use a hint book.

It's possible to read all the answers to a hint question at the same time. This will give you the solution to the puzzle without any need on your part to figure anything out. Easy, but ultimately unsatisfying. We don't recommend this method.

The other way of using a hint book is to reveal only one answer at a time and try to figure out the solution on your own, only looking at the next answer down when you're genuinely stuck. This method is a bit more challenging, but it will increase your enjoyment of the game.

After You've Finished the Game

The last section of this book contains a points list for the game. If you've played through and want to see what you might have missed, take a look.



Note to Beginning Adventurers

If you've never played a Sierra 3-D Animated Adventure Game, here are some tips to help you get started:

- 1) Remember to save your game frequently, especially whenever you're about to try something that could be risky. If you mess up, you can restore to your previous position and try something different. Your game manual has more details on saving and restoring games.
- 2) Pay attention. Look at everything and talk to everyone. Pick up anything that's not nailed down. You never know where you might pick up a valuable object or clue.
- 3) Try anything. Anything you try might be the solution to a game situation. Just remember to save first (see 1, above).
- 4) Last and most important: Have fun!

My Exploits as a Space Hero or, How I Learned to Stop Thinking and Love the Space Quest Series by Roger Wilco

Let's face it - there aren't many guys who have risen from the lower levels of sanitation engineering to the prominent position of galactic hero, but if I do say so myself, I've handled my fame well.

I started out my career in *Space Quest I: The Sarien Encounter* with a highly responsible position in the custodial department aboard the scientific research vessel, Arcada. When the ship was invaded by slimy Sariens, I singlehandedly saved the top-secret Star Generator project from being turned to destructive purposes. For that bit of daring I was awarded the Order of the Golden Mop. After that, I kind of thought my life would get back to normal again, but little did I know that I had attracted the attention of the evil being responsible for the Sarien invasion, the large and thoroughly unpleasant Sludge Vohaul. Sludge planned a truly ghastly vengeance for my home galaxy in *Space Quest II: Vohaul's Revenge* - an

invasion of genetically engineered insurance salesmen. Luckily I was able to outwit him, foil his plans and escape his asteroid stronghold in one piece before it blew Sludge and his Sarien goons into hard vacuum.

Seeing no hope of a quick rescue, I was forced to activate the cryonic sleep chamber aboard the escape ship. When I woke up, I was being hauled in by a trash freighter, and that was the good news! The bad news was that this was *Space Quest III: The Pirates of Pestulon*, and The Two Guys From Andromeda, my game authors, had been shanghaied to a life of software slavery. It's a good thing they had me looking out for them, because after some truly hair-raising close shaves I was able to rescue them. You'd think they'd be grateful, but not these guys - they got cushy jobs at Sierra and left me to get back to Xenon on my own.

When I got there, I found myself in the middle of trouble, not to mention the middle of *Space Quest IV: Roger Wilco and the Time Rippers*. Sludge Vohaul was back, and he wanted me and the whole Space Quest series eliminated once and for all. I had to travel in time back to Space Quest I and forward as far as Space Quest XII! Boy, was I mixed up, but I finally managed to defeat Vohaul once and for all (I hope!) and were there ever some surprises in that one!

It's been a wild and thrilling ride, and I can't wait to see where my sensational space adventures will take me next. Wherever that is, I hope you'll travel along.

Roger Wilco



General Questions

Roger moves: (pick one) a) too slow b) too fast. What can I do?

On your icon bar is a control panel icon with a slider bar. Choose it to bring up the control panel. You'll see a slider for adjusting the animation speed. If your game still runs too slowly, adjust the animation detail slider down until you find a speed and detail level you can live with.

Getting around in the game

Point and click pointers

How do I look at things, talk to people, and stuff like that?

Check out the icon bar at the top of the screen (press ESC or place the cursor at the very top of the screen to see the icon bar). These icons represent all possible game activities.

When you choose an icon, the cursor will change to that shape. You can also click your right mouse button (or Shift-Click) to cycle through the cursors and the middle mouse button (or Ctrl-Click) to toggle between the walk cursor and the last other cursor used.

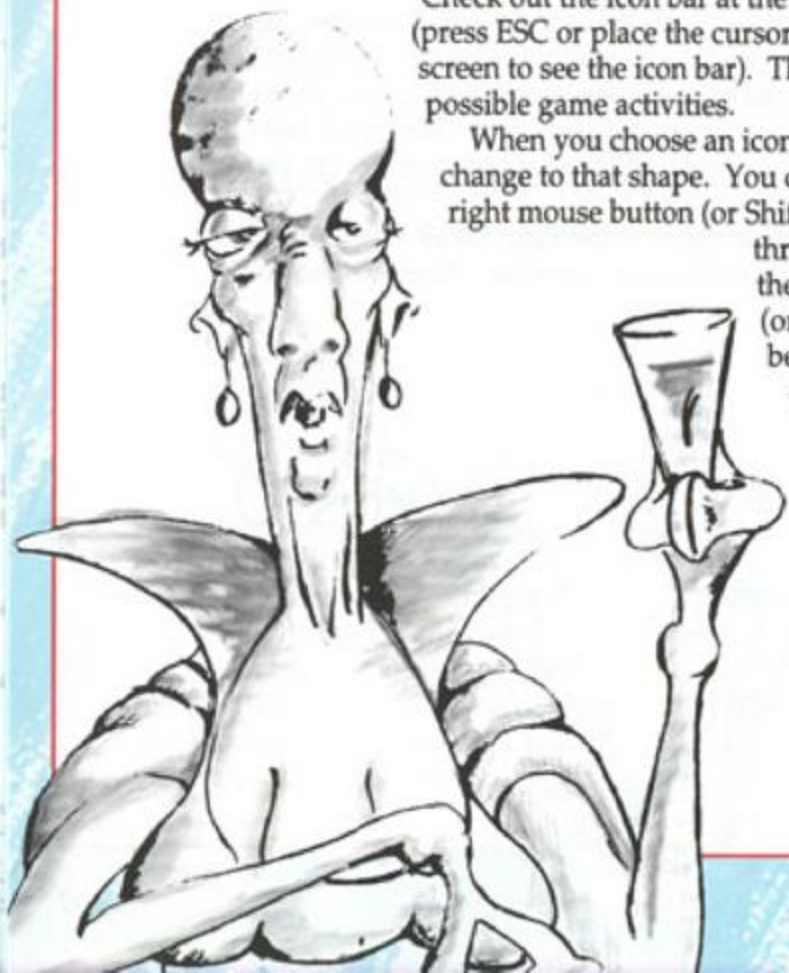

Example:

To talk to someone, click the talking head cursor on them;

To look at something, click the eye cursor on it.

To walk somewhere, click the walking figure cursor on that screen position.

To take action on something or someone, click the hand cursor on the person or thing. This cursor performs many different game actions. You will want to use it liberally.

Example:

To search a dead body, click the hand cursor on it; to put on a spacesuit, click the hand cursor on the suit; to press a button, click the hand cursor on the button.

To smell or taste something, choose the nose or mouth icon.

How do I get things in and out of my inventory?

To pick up an item from a game screen, click the hand cursor on it.

If it's something you can take, you will now have it in your inventory.

To take something out of inventory, choose the inventory icon. You will see your inventory items onscreen. To take an inventory item, click the arrow cursor on it. To look at an item, click the eye on it. To take action on an item, click the hand on it. To act on it with another inventory item, click the arrow on one item, then click that item's cursor on the other item.

To give an inventory item to someone, or to use an inventory item somewhere in the game, go to the inventory screen and use the arrow cursor to choose the item. You will now have a cursor shaped like that item. Click the item cursor on the person or place of your choice.

Example:

To shoot a Sarien with a PulseRay, click the PulseRay cursor on the Sarien.

To stop up a steam vent with a rock, click the rock cursor on the steam vent.



A Sierra Artist creates an exciting new look for an old favorite.

Evolution...

As *Space Quest I* underwent its transformation to the latest in graphic technology, it became obvious that the old cliffs and cave screens from the original needed some new touches to match the 1950's comic book flavor of the updated version. The result was this spectacular 9-screen scrolling area containing the bones of a long-extinct behemoth known to science as the Doug-o-saurus. The Orat cave, once hidden somewhere in the cliffside, is now located in the monster's huge skull.

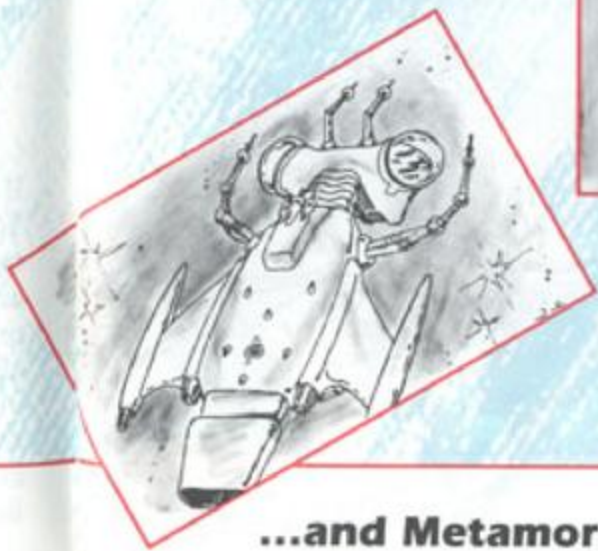

...and Metamorphosis

With the greatly increased color and resolution capabilities of today's computer systems, and the greatly enhanced expectations of today's game players, the images in the updated *Space Quest I* needed to be more dynamic and effective than ever before. Under the direction of *Space Quest I*'s Art Designer, the Sarien ship Deltaur and the Xenon research vessel Arcada took on completely new and unique personalities.



Turnabout...

A number of different approaches were tried for Tiny, *Space Quest I*'s crafty alien used-spaceship salesman, from the unquestionably menacing to the merely malevolent. When it was decided that the character should be less threatening, this suitably sociable but shrewd salesguy emerged to become the official Tiny.



...and Transition

These artists' sketches show the evolution of Tunuctipin, known to his pals in the Sierra Creative Development Department as Turnip Head. The Keronian elder is encountered by Roger in the underground generator room far beneath the arid desert of the planet Kerona, where Roger has crash-landed his escape pod.



Sierra artists work on the 3-D models for the *Space Quest I* opening sequence.

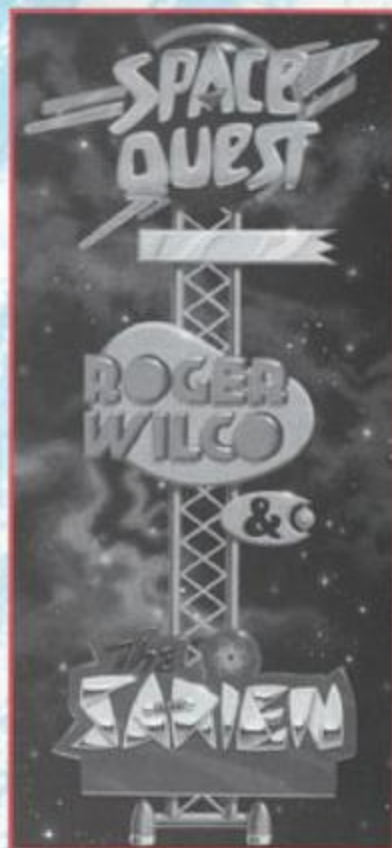

Sierra music men consult on the *Space Quest I* soundtrack.



Adding a Dimension

Three-dimensional clay models were used to create some of the spectacular 3-D effects in the *Space Quest I* opening credits sequence. The models were videotaped and the video scanned into computer graphics to create the finished animation.

Music & Sound

When the original *Space Quest I* was released in 1987, original stereo soundtracks for computer adventures were still not reality. By the time the game was updated for the '90's, however, improvements in sound technology had brought about a dramatic difference. The terrific score for the new *Space Quest I* adds dimension and intensity to the game while setting just the right mood for each scene.

Game Hints

Aboard The Arcada

The Arcada is going to self-destruct! What do I do?

- Go to the Data Archive room to the west of the Data Center and get out of the Data Center.
- You need a data cartridge from the Data Storage room.
- You need a data cartridge from the Data Storage room.
- When you have the cartridge, go to the Data Center and use the keypad to enter up the cartridge, using the code found in your game's instruction book. A robot will appear and give you a data cartridge.
- Use the data cartridge with the cartridge slot in the Data Center to take a data cartridge from the Data Center.

What's the deal with all these bodies everywhere?

- They're the bodies of the people who were killed by the aliens.
- You need to find a way to get rid of them.
- You need to find a way to get rid of them.
- You need to find a way to get rid of them.
- You need to find a way to get rid of them.
- You need to find a way to get rid of them.

No matter where I go, big ugly aliens shoot me.

- You need to find a way to get rid of them.
- You need to find a way to get rid of them.
- You need to find a way to get rid of them.
- You need to find a way to get rid of them.
- You need to find a way to get rid of them.
- You need to find a way to get rid of them.

What do I need from the Data Archive room, and where the heck is it, anyway?

- The Data Archive room is the room to the west of the Data Center and get out of the Data Center.
- You need a data cartridge from the Data Storage room.
- You need a data cartridge from the Data Storage room.
- When you have the cartridge, go to the Data Center and use the keypad to enter up the cartridge, using the code found in your game's instruction book. A robot will appear and give you a data cartridge.
- Use the data cartridge with the cartridge slot in the Data Center to take a data cartridge from the Data Center.

I'm in the Star Generator room, but I don't see anything I need here.

- You need to find a way to get rid of them.
- You need to find a way to get rid of them.
- You need to find a way to get rid of them.
- You need to find a way to get rid of them.
- You need to find a way to get rid of them.
- You need to find a way to get rid of them.

Where's the Flight Preparation Room? What do I do there?

- You need to find a way to get rid of them.
- You need to find a way to get rid of them.
- You need to find a way to get rid of them.
- You need to find a way to get rid of them.
- You need to find a way to get rid of them.
- You need to find a way to get rid of them.

Game Hints

board The Arcada

The Arcada is going to self-destruct! What do I do?

- Get off the ship before it blows up, for one thing.
- For another, make sure you have everything you need before you leave.
- You'll need to visit several places on the ship and pick up items you'll need later.
- Don't leave the ship until you've been to the Data Archives (twice), the Star Generator room, the Central Control area and the Flight Preparation room.

What's the deal with all these bodies everywhere?

- They're dead, Jim.
- But one of them can still be of help to you.
- A dead guy named Jerry has the keycard you need to get into the special elevator downstairs.
- Go to the east side of the upper level and search the body there. Take the keycard and use it on the elevator located in the right hand wing of the central control area, that leads to the flight preparation room.
- To search Jerry, use the hand cursor on his body. To use the keycard in the elevator, use its cursor on the elevator control panel.

No matter where I go, big ugly aliens shoot me.

- It's their job.
- Some good advice: avoid big ugly aliens whenever possible.
- Whenever you hear footsteps, duck into the nearest door or behind something. When they don't see anything, they'll go away.
- In the central control area, downstairs, you'll have to be completely hidden behind the giant joystick or the giant mouse to avoid them.

What do I need from the Data Archive room, and where the heck is it, anyway?

- The Data Archive is the room to the west of the door you came out of at the beginning of the game.
- You need a data cartridge from the data storage modules.
- You can't get it until you've been in the room twice, and a wounded man comes in and gives you the code for the cartridge.
- When you have the code, sit down at the console and use the keypad to order up the cartridge, using the code found in your game documentation. A robot will retrieve it for you.
- When the robot comes back with the cartridge, don't forget to take it with you.
- Use the hand cursor on the console to see a close-up view. Use the hand cursor to enter the code on the keypad. Use the hand cursor on the cartridge to take it from the robot.

I'm in the Star Generator room, but I don't see anything I need here.

- Look harder. It's small.
- See the smashed Star Generator mounting on the floor? Look closer.
- On the left hand side of the mounting, something is sparkling.
- It's a magnetic widget, used by the Sariens to release the Star Generator from its mountings. Looks useful, doesn't it?
- Take it. It'll improve your luck later.
- Use the hand cursor on the flashing object on the left hand side of the Star Generator mounting to get the widget.

Where's the Flight Preparation Room? What do I do there?

- It's on the lowest level, east of the Central Control Area.
- The central control area is the three rooms on the lowest level of the ship. You get there by taking the elevator with the black and yellow doors.
- When you get there, take the gadget from the drawer on the North wall.
- Wear the spacesuit from the closet on the North wall.
- Use the hand cursor on the drawer to open it and take the gadget.

* I tried to push the middle button, but it didn't work. I tried to push the other buttons, but they didn't work either. I tried to push the middle button again, but it didn't work.

I found the door to the escape pod bay, but when I went through, I popped like a balloon!

- I found the door to the escape pod bay, but when I went through, I popped like a balloon!
- I tried to push the middle button, but it didn't work. I tried to push the other buttons, but they didn't work either. I tried to push the middle button again, but it didn't work.
- I tried to push the middle button, but it didn't work. I tried to push the other buttons, but they didn't work either. I tried to push the middle button again, but it didn't work.
- I tried to push the middle button, but it didn't work. I tried to push the other buttons, but they didn't work either. I tried to push the middle button again, but it didn't work.
- I tried to push the middle button, but it didn't work. I tried to push the other buttons, but they didn't work either. I tried to push the middle button again, but it didn't work.

I'm in the escape pod, but can't get it to go anywhere.

- I tried to push the middle button, but it didn't work. I tried to push the other buttons, but they didn't work either. I tried to push the middle button again, but it didn't work.
- I tried to push the middle button, but it didn't work. I tried to push the other buttons, but they didn't work either. I tried to push the middle button again, but it didn't work.
- I tried to push the middle button, but it didn't work. I tried to push the other buttons, but they didn't work either. I tried to push the middle button again, but it didn't work.
- I tried to push the middle button, but it didn't work. I tried to push the other buttons, but they didn't work either. I tried to push the middle button again, but it didn't work.
- I tried to push the middle button, but it didn't work. I tried to push the other buttons, but they didn't work either. I tried to push the middle button again, but it didn't work.

Every time I try to leave the ship, I get pulped against the bay doors. Why won't they open?

- I tried to push the middle button, but it didn't work. I tried to push the other buttons, but they didn't work either. I tried to push the middle button again, but it didn't work.
- I tried to push the middle button, but it didn't work. I tried to push the other buttons, but they didn't work either. I tried to push the middle button again, but it didn't work.
- I tried to push the middle button, but it didn't work. I tried to push the other buttons, but they didn't work either. I tried to push the middle button again, but it didn't work.
- I tried to push the middle button, but it didn't work. I tried to push the other buttons, but they didn't work either. I tried to push the middle button again, but it didn't work.
- I tried to push the middle button, but it didn't work. I tried to push the other buttons, but they didn't work either. I tried to push the middle button again, but it didn't work.

It says not to push the middle button. Should I push it anyway?

- I tried to push the middle button, but it didn't work. I tried to push the other buttons, but they didn't work either. I tried to push the middle button again, but it didn't work.
- I tried to push the middle button, but it didn't work. I tried to push the other buttons, but they didn't work either. I tried to push the middle button again, but it didn't work.

I got the escape pod to go, but then I just wandered around and got lost in space.

- I tried to push the middle button, but it didn't work. I tried to push the other buttons, but they didn't work either. I tried to push the middle button again, but it didn't work.
- I tried to push the middle button, but it didn't work. I tried to push the other buttons, but they didn't work either. I tried to push the middle button again, but it didn't work.
- I tried to push the middle button, but it didn't work. I tried to push the other buttons, but they didn't work either. I tried to push the middle button again, but it didn't work.
- I tried to push the middle button, but it didn't work. I tried to push the other buttons, but they didn't work either. I tried to push the middle button again, but it didn't work.
- I tried to push the middle button, but it didn't work. I tried to push the other buttons, but they didn't work either. I tried to push the middle button again, but it didn't work.

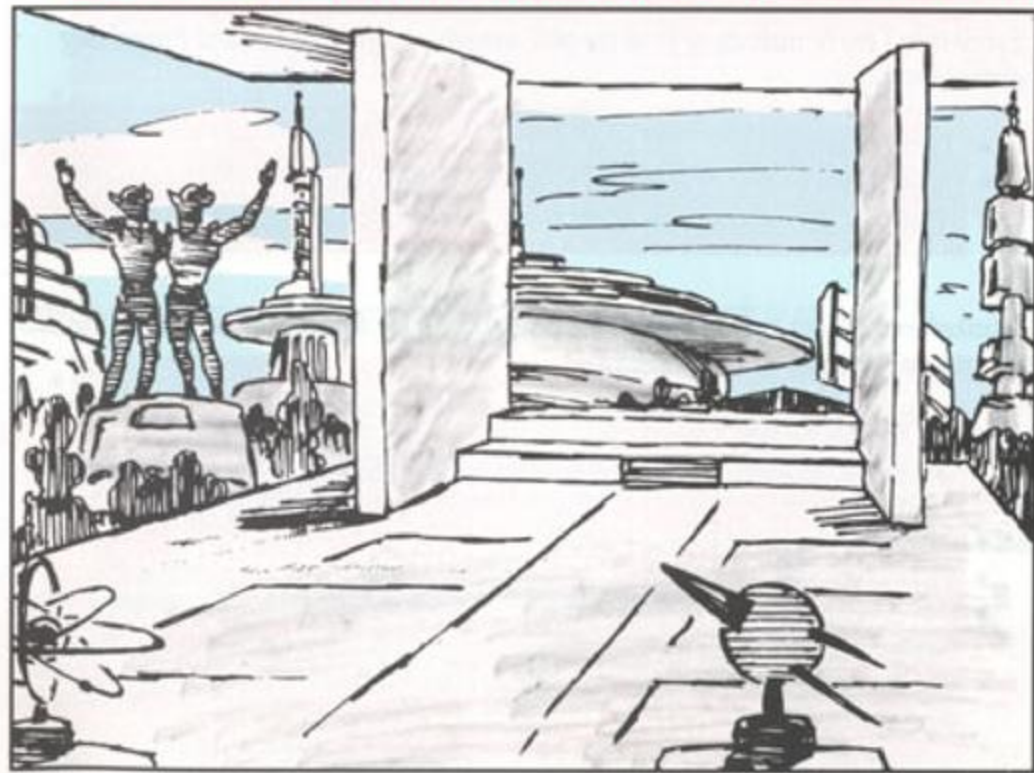

Preliminary sketch of the parade ground on Xenon where our Hero receives his golden mop. Our tribute to the Two Guys from Andromeda stands out as a statue in the background.

- Use the hand cursor on the closet door controls to the right of the drawer to open the closet and see the spacesuit. Use the hand cursor on the spacesuit to put it on.

I found the door to the escape pod bay, but when I went through, I popped like a balloon!

- I know. I hate it when that happens.
- The door is there to keep out the vacuum on the other side.
- Since you have to go out in that vacuum it might be best to put on a spacesuit.
- There's one in the closet on the North side of the room.
- Use the hand cursor on the closet door to open it and see the spacesuit. Use the hand cursor on the spacesuit to put it on.

I'm in the escape pod, but can't get it to go anywhere.

- Push the power button, then pull back on the throttle.
- There's a bank of three buttons on your upper right. The power button is the one on the far right.
- Don't push anything until you've opened the pod bay doors.
- And fasten your seat belt, please.
- Use the hand cursor on a button to push it. Use the hand cursor on the throttle lever to pull it. Use the hand cursor on your seat belt to put it on.

Every time I try to leave the ship, I get pulped against the bay doors. Why won't they open?

- Because you didn't open them.
- The controls to the bay doors are in the Central Control Area.
- There are two buttons underneath the viewport that looks out on the bay doors. Look at them to get a closer view, then push the one that says OPEN.
- Use the eye cursor on the buttons under the viewport to see a close-up view. Use the hand cursor on the OPEN to push it.

It says not to push the middle button. Should I push it anyway?

- It's up to you. Do you just have this thing about doing what you've been told not to do? All right then. Live dangerously.
- But save your game first.

I got the escape pod to go, but then I just wandered around and got lost in space.

- That's because you didn't tell the pod where you wanted it to go.
- There's a button in here just for that purpose. It's called the AutoNav button.
- It's the far left button on the panel above your head.
- Use the hand cursor on the AutoNav button to push it.

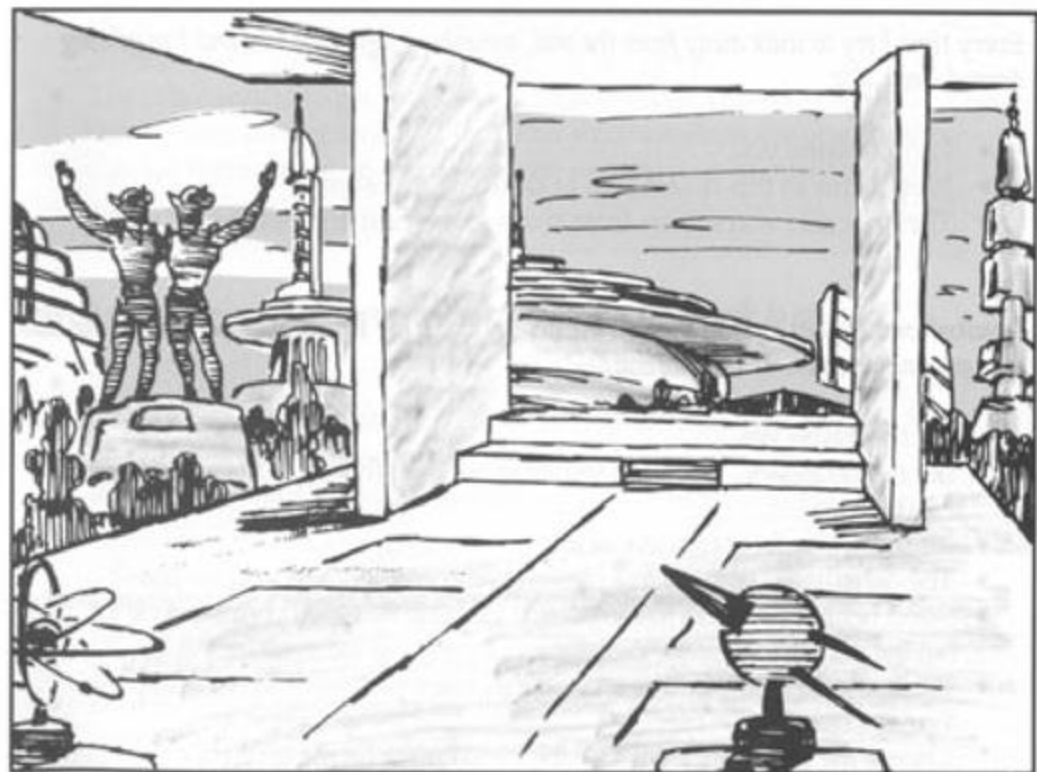

Preliminary sketch of the parade ground on Xenon where our Hero receives his golden mop. Our tribute to the Two Guys from Andromeda stands out as a statue in the background.

The Burning Desert On The Planet Kerona

I crash-landed in the desert. Is there anything I need to take with me from the pod?

- I should take a flashlight.
- I should take a first aid kit.
- I should take a water purifier.
- I should take a multi-tool.
- I should take a survival knife.
- I should take a map of the planet.
- I should take a compass.
- I should take a survival blanket.
- I should take a survival whistle.
- I should take a survival signal flare.
- I should take a survival signal mirror.
- I should take a survival signal flare.
- I should take a survival signal mirror.
- I should take a survival signal flare.
- I should take a survival signal mirror.

Every time I try to walk away from the pod, something ugly eats me, and I'm getting darned tired of it.

- I should take a flashlight.
- I should take a first aid kit.
- I should take a water purifier.
- I should take a multi-tool.
- I should take a survival knife.
- I should take a map of the planet.
- I should take a compass.
- I should take a survival blanket.
- I should take a survival whistle.
- I should take a survival signal flare.
- I should take a survival signal mirror.
- I should take a survival signal flare.
- I should take a survival signal mirror.
- I should take a survival signal flare.
- I should take a survival signal mirror.

I walked into a giant animal skull in the desert, and a big smelly monster stuffed me into my spacesuit helmet. Is this normal?

- I should take a flashlight.
- I should take a first aid kit.
- I should take a water purifier.
- I should take a multi-tool.
- I should take a survival knife.
- I should take a map of the planet.
- I should take a compass.
- I should take a survival blanket.
- I should take a survival whistle.
- I should take a survival signal flare.
- I should take a survival signal mirror.
- I should take a survival signal flare.
- I should take a survival signal mirror.
- I should take a survival signal flare.
- I should take a survival signal mirror.

What are the weird purple plants that grow near the skeleton?

- I should take a flashlight.
- I should take a first aid kit.
- I should take a water purifier.
- I should take a multi-tool.
- I should take a survival knife.
- I should take a map of the planet.
- I should take a compass.
- I should take a survival blanket.
- I should take a survival whistle.
- I should take a survival signal flare.
- I should take a survival signal mirror.
- I should take a survival signal flare.
- I should take a survival signal mirror.
- I should take a survival signal flare.
- I should take a survival signal mirror.

The Spider Droid keeps chasing me around the giant skeleton. Is there any way to get rid of it?

- I should take a flashlight.
- I should take a first aid kit.
- I should take a water purifier.
- I should take a multi-tool.
- I should take a survival knife.
- I should take a map of the planet.
- I should take a compass.
- I should take a survival blanket.
- I should take a survival whistle.
- I should take a survival signal flare.
- I should take a survival signal mirror.
- I should take a survival signal flare.
- I should take a survival signal mirror.
- I should take a survival signal flare.
- I should take a survival signal mirror.

There's a broken piece of backbone on the giant skeleton. Is it safe to walk on?

- I should take a flashlight.
- I should take a first aid kit.
- I should take a water purifier.
- I should take a multi-tool.
- I should take a survival knife.
- I should take a map of the planet.
- I should take a compass.
- I should take a survival blanket.
- I should take a survival whistle.
- I should take a survival signal flare.
- I should take a survival signal mirror.
- I should take a survival signal flare.
- I should take a survival signal mirror.
- I should take a survival signal flare.
- I should take a survival signal mirror.

Is there anything else I should know about the giant skeleton?

- I should take a flashlight.
- I should take a first aid kit.
- I should take a water purifier.
- I should take a multi-tool.
- I should take a survival knife.
- I should take a map of the planet.
- I should take a compass.
- I should take a survival blanket.
- I should take a survival whistle.
- I should take a survival signal flare.
- I should take a survival signal mirror.
- I should take a survival signal flare.
- I should take a survival signal mirror.
- I should take a survival signal flare.
- I should take a survival signal mirror.

The Burning Desert On The Planet Kerona

I crash-landed in the desert. Is there anything I need to take with me from the pod?

- Yes.
- There's a survival kit in the pod. You'll need it.
- Get out of the pod, then take the kit from the pod doorway.
- There's also a piece of reflective glass that fell out of the windshield onto the ground when you landed. Get that, too.
- Use the hand cursor on the seat belt to exit the pod. Use the hand cursor on the kit inside the pod doorway to take it. Use the hand cursor on the piece of glass on the ground to take it.

Every time I try to walk away from the pod, something ugly eats me, and I'm getting darned tired of it.

- I don't blame you.
- Most paths in this desert lead to death by ingestion.
- The only safe ways away from the pod are East and Southeast.

I walked into a giant animal skull in the desert, and a big smelly monster stuffed me into my spacesuit helmet. Is this normal?

- For this game, yes.
- But not necessary. You have something on you that will kill the Orat before it can kill you.
- It's something in your survival kit.
- The dehydrated water is in a pressurized container. Did you see Jaws?
- Stand behind the rocks just inside the giant skull. Open your survival kit. Take out the dehydrated water canister and throw it at the monster.
- While you're at it, take that icky little monster part that's left over after the explosion.
- Choose the Inventory icon. Use the hand cursor on the survival kit to open it. Choose the dehydrated water canister icon. Use the canister icon on the Orat to throw the canister. Use the hand cursor on the Orat part to take it.

What are the weird purple plants that grow near the skeleton?

- Weird, purple, smelly and sticky, that's what.
- Also useful. Take a sample. It might just save your life later.
- Use the hand cursor on one of the purple plants to take a sample.

The Spider Droid keeps chasing me around the giant skeleton. Is there any way to get rid of it?

- A couple of ways, actually.
- You can drop something on it, or let something even worse take care of it for you.
- Get the Spider Droid to chase you to the neckbone of the giant skeleton, where you can walk up onto the spine. Go to the loose piece of bone on the spine. Wait until the Spider Droid is underneath the spine and coming out the other side. Push the bone down on top of it.
- The other way is to get the Spider Droid to chase you into the skull. Then hide behind the big rock and let it and the Orat eliminate one another.
- Use the hand cursor on the loose bone to drop it on the Spider Droid.

There's a broken piece of backbone on the giant skeleton. Is it safe to walk on?

- No.
- It will support your weight three times without falling.
- The third time you cross over, you're dead.
- It's not necessary to cross it more than three times.

Is there anything else I should know about the giant skeleton?

- Yes. It contains a secret entrance to an underground cavern.
- Walk down the spine from the neckbone, and you should find it.
- It's near the tail.
- Between two of the big spikes there's a place that will open up and dump you into the underground cavern.

The big alien head sent me back to the surface, but I can't find the Orat he's talking about.

- I tried to ask the Orat what he was talking about, but he just looked at me and said "Orat".
- I tried to ask the Orat what he was talking about, but he just looked at me and said "Orat".
- I tried to ask the Orat what he was talking about, but he just looked at me and said "Orat".

I found the Orat, but then he found me. Now I'm dead.

- I tried to ask the Orat what he was talking about, but he just looked at me and said "Orat".
- I tried to ask the Orat what he was talking about, but he just looked at me and said "Orat".
- I tried to ask the Orat what he was talking about, but he just looked at me and said "Orat".

One of a number of alien bimbettes designed for the bar scene. This particular sketch fantasied aspects of alien anatomy that we felt had been overused, so it was de-emphasized in the final version. Ultimately the close up of the bimette was never used.



Kerona - Underground

I fell into this underground room with a grate in the floor, and there's a monster under the grate, and it looks hungry.

- I tried to ask the Orat what he was talking about, but he just looked at me and said "Orat".
- I tried to ask the Orat what he was talking about, but he just looked at me and said "Orat".
- I tried to ask the Orat what he was talking about, but he just looked at me and said "Orat".

How do I get on the other side of the strange glowing door?

- I tried to ask the Orat what he was talking about, but he just looked at me and said "Orat".
- I tried to ask the Orat what he was talking about, but he just looked at me and said "Orat".
- I tried to ask the Orat what he was talking about, but he just looked at me and said "Orat".

What's the pool of green stuff?

- I tried to ask the Orat what he was talking about, but he just looked at me and said "Orat".
- I tried to ask the Orat what he was talking about, but he just looked at me and said "Orat".
- I tried to ask the Orat what he was talking about, but he just looked at me and said "Orat".

The big alien head sent me back to the surface, but I can't find the Orat he's talking about.

- You're not looking very hard.
- If you were an Orat, where would you hide?
- The Orat lives in the giant skull in the desert.

I found the Orat, but then he found me. Now I'm dead.

- I never said being a hero would be easy.
- See the hint about the giant skull and the big smelly monster that stuffs you into your spacesuit helmet.
- And have a nice day.

One of a number of alien bimbettes designed for the bar scene. This particular sketch fantasied aspects of alien anatomy that we felt had been overused, so it was de-emphasized in the final version. Ultimately the close up of the bimchette was never used.



erona - Underground

I fell into this underground room with a grate in the floor, and there's a monster under the grate, and it looks hungry.

- It is. I don't advise going near it.
- You say you have to go near it to get past the grate? That is too bad. Maybe you have something it would like.
- Does it look vegetarian?
- Give it the piece of purple plant you picked up in the desert.
- If you didn't pick up a piece of purple plant in the desert, check out the big pointy rock in the room to the east. Someone used some of the sticky plant to glue the rock together.
- Use the hand cursor on either the plant in the desert or the piece of plant on the rock to take a sample. Use the plant cursor on the grate monster to throw it a piece.

How do I get on the other side of the strange glowing door?

- See that steam vent near the door? The door works on steam pressure.
- If you could plug up the vent, the resulting pressure might open the door.
- What have you seen down here that might fit into that hole?
- Near the shaft you fell out of, there's a large pointy rock. Break off the top and put it in the vent.
- Use the hand cursor on the top of the pointy rock to break off the top piece. Use the rock cursor on the steam vent to put the rock in the vent.

What's the pool of green stuff?

- It's *not* lime Kool-Aid.
- It is loathsome, horrid, awful, flesh-eating green acid.
- Don't touch it unless you've just saved your game and want a few laughs.

There's more of that green stuff dripping from the ceiling. I get the feeling that's not good.



There's a big alien head talking to me, and I can't understand a word it's saying.



I'm in the steam generator room. Is there anything I need here?



That skimmer ride was a real killer!

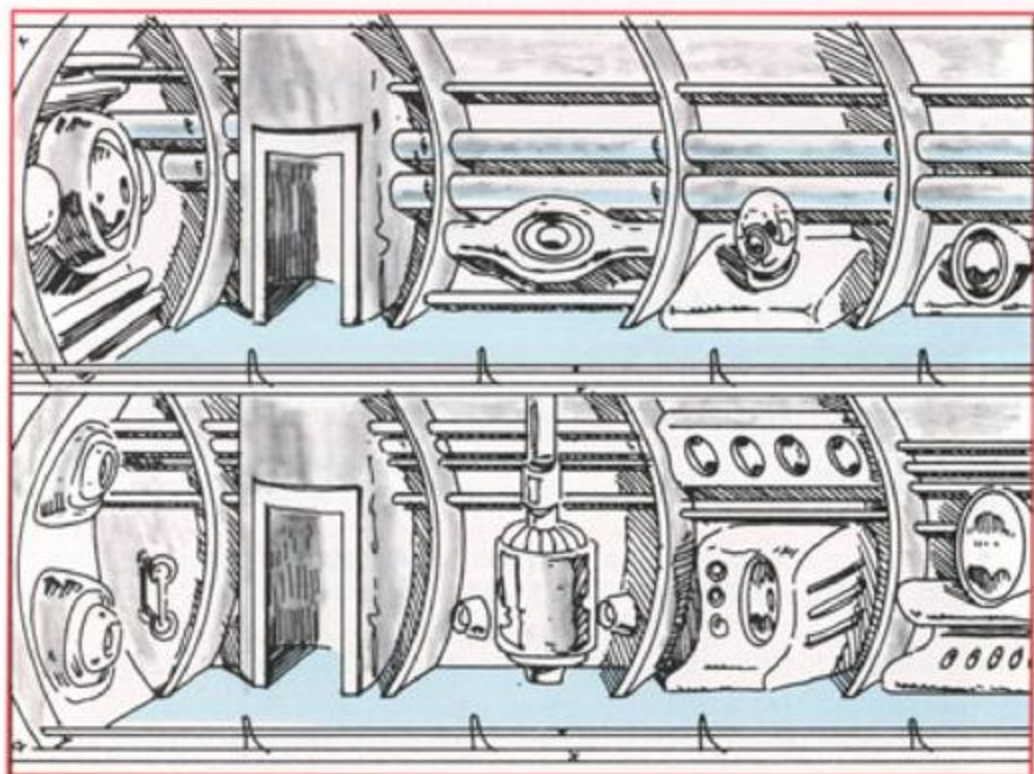

Preliminary sketch from the Deltaur - we attempted to capture the '50's spaceship interior look - with lots of conduits and gauges and exposed hardware - reminiscent of E.C. Comics™.

There's more of that green stuff dripping from the ceiling. I get the feeling that's not good.

- No, it's just fine unless it touches you.
- Then it could be a definite problem.
- Be sure to save your game, then only step in the places where the acid doesn't fall.
- See those holes the acid has worn in the path? Save your game, then step above, below or beyond the holes to avoid the acid, saving again when you make progress. The drops are timed randomly, so there's no particular pattern to the way they fall. If you can't see the holes in the ground, turn your monitor's brightness level up.

There's a big alien head talking to me, and I can't understand a word it's saying.

- I guess you and he just don't speak the same language.
- If you only had one of those translator gadgets, like they had back on the Arcada...
- ...in the Flight Preparation Room.
- You do? Is it turned on?
- Turn the gadget on, but not too soon. After you get past the acid drops is the best time.
- Use the hand cursor on the gadget in your inventory to turn it on and off.

I'm in the steam generator room. Is there anything I need here?

- Well, remember how you couldn't read that data cartridge back on the Arcada?
- Maybe you could read it here - but where?
- Try the computer in the upper right corner.
- Put the data cartridge into the computer and read the message, paying special attention to the self-destruct instructions.
- Then take the skimmer they offered you and beat it out of there.
- Use the cartridge cursor on the computer to read the cartridge. Use the hand cursor on the cartridge to take it out of the computer. Use the hand cursor on the skimmer to get in and go.

That skimmer ride was a real killer!

- Next time skip the arcade sequence and enjoy the ride.
- If you just *have* to play the arcade sequence, save your game first, then turn the game's speed control to the lowest possible setting. Use the arrow keys, mouse or joystick to control the skimmer's side-to-side movement. For minimum frustration, continue to save your game every time you get past a rock without damage (check the damage meter in the lower right corner of the screen).

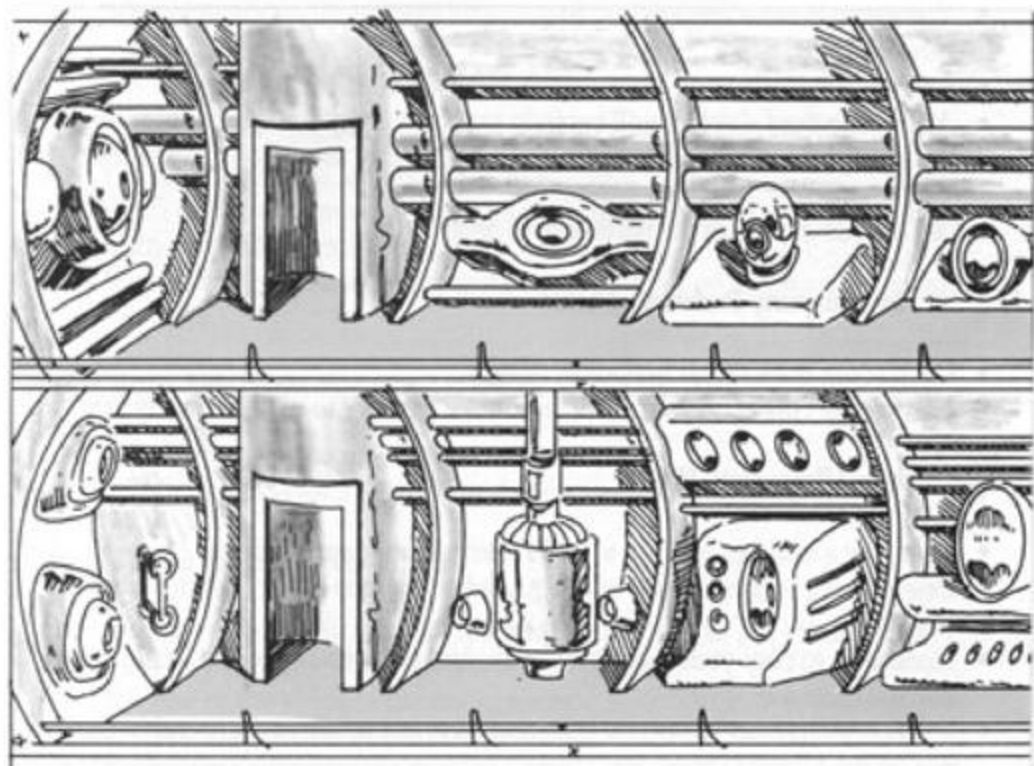

Preliminary sketch from the Deltaur - we attempted to capture the '50's spaceship interior look - with lots of conduits and gauges and exposed hardware - reminiscent of E.C. Comics™.

Kerona - Ulence Flats

I just arrived in beautiful downtown Ulence Flats, and a guy offered to buy my skimmer. Should I sell it?

- The guy is a local resident and a well-known collector of Buckazoids.
- He has a large collection of Buckazoids and is looking for a good deal.
- He has offered to buy your skimmer for a price that is significantly higher than what you would get if you sold it elsewhere.
- He has also offered to buy your skimmer for a price that is significantly higher than what you would get if you sold it elsewhere.

I'm in the bar. What a zoo! Is there something useful I can do here?

- You can play the slot machine and win a lot of money.
- You can play the slot machine and win a lot of money.
- You can play the slot machine and win a lot of money.
- You can play the slot machine and win a lot of money.
- You can play the slot machine and win a lot of money.

How can I tell how many Buckazoids I have?

- Look at the Buckazoids in your collection.
- Use the Buckazoid counter in the game.

I'm flat broke in Ulence Flats. Help!

- There are a number of ways to make money in Ulence Flats.
- You can play the slot machine and win a lot of money.
- You can play the slot machine and win a lot of money.
- You can play the slot machine and win a lot of money.
- You can play the slot machine and win a lot of money.
- You can play the slot machine and win a lot of money.

I thought about investing a few Buckazoids in the slot machine, but it just toasted that little alien fella.

- The slot machine is a great way to make money.
- The slot machine is a great way to make money.
- The slot machine is a great way to make money.
- The slot machine is a great way to make money.
- The slot machine is a great way to make money.
- The slot machine is a great way to make money.

I came out of the bar and my skimmer was gone!

- The skimmer was stolen by a thief.
- The skimmer was stolen by a thief.
- The skimmer was stolen by a thief.
- The skimmer was stolen by a thief.
- The skimmer was stolen by a thief.
- The skimmer was stolen by a thief.

A cute, fuzzy, little brown alien wants to sell me a spaceship. Should I go with him?

- The alien is a good deal.
- The alien is a good deal.

Should I buy a spaceship from Tiny's?

- The spaceship is a great deal.
- The spaceship is a great deal.
- The spaceship is a great deal.
- The spaceship is a great deal.
- The spaceship is a great deal.
- The spaceship is a great deal.

erona - Ulence Flats

I just arrived in beautiful downtown Ulence Flats, and a guy offered to buy my skimmer. Should I sell it?

- Yes.
- But don't take his first offer.
- The second offer includes a jet pack, an item you'll find quite useful later.
- If you don't have the jet pack, you can kiss off getting onto the Deltaur to find the Star Generator.

I'm in the bar. What a zoo! Is there something useful I can do here?

- You mean besides engaging in meaningful intellectual conversation with the other patrons?
- Several things, actually. First, relax and have a drink. Have three.
- After your third drink, you'll begin to overhear an interesting conversation. Pay special attention to what you hear, particularly the sector number that is mentioned.
- Use the talk cursor on the bartender to order drinks.

How can I tell how many Buckazoids I have?

- Look at the Buckazoids in your inventory.
- Use the eye cursor on your Buckazoids in inventory to see how many you have.

I'm flat broke in Ulence Flats. Help!

- There are a number of ways to make some money around here.
- One is to sell your skimmer to the guy who wants to buy it (just don't take his first offer).
- Another is to play your measly three Buckazoids into big buckz. at the rocket bar slot machine.
- If you're even more desperate than that, you can go digging around in the dust pile on the East side of the bar - there's usually some slightly crispy Buckazoids in there.
- Use the hand cursor on the slot machine to get a close-up view, and on the slot machine buttons to operate it. Use the hand cursor on the dustpile to find any Buckazoids in the pile.

I thought about investing a few Buckazoids in the slot machine, but it just toasted that little alien fella.

- That's why they call it a game of chance.
- When you lose on this baby, you *lose*, if you take my meaning.
- That's why you should save your game before you play, and again whenever you make some money. If you lose, restore the previous game. Keep this up until you have 250 Buckazoids. Just for fun, you can play until you have 300 Buckazoids, and watch the machine blow up.
- If you had a magnetic widget to attach to the machine, it would improve your luck.
- The widget was back on the Arcada in the Star Generator Room.
- Use the hand cursor on the slot machine buttons to operate them. Use the widget cursor on the slot machine to attach the widget.

I came out of the bar and my skimmer was gone!

- This is a tough neighborhood.
- You shouldn't have left your keys in it.
- You'll need the skimmer to get a jet pack, so this might be a good time to practice your Restore Game moves.
- After arriving at Ulence Flats, use the hand cursor on the skimmer to take your keys.

A cute, fuzzy, little brown alien wants to sell me a spaceship. Should I go with him?

- Only if you think being mugged is a real hoot.
- Otherwise, go West to Tiny's Used Spaceships instead.

Should I buy a spaceship from Tiny's?

- Not only *should* you, but you'd *better* if you want to get off this rock.
- Don't buy either of the ships in the foreground.
- Pick one of the ships in the background.
- Not the little saucer-shaped number.
- Buy the ship with the ladder.
- Use the talk cursor on Tiny to talk to him. Use the talk cursor on a spaceship to talk to Tiny about that particular ship. After talking to Tiny about the ship, use the Buckazoid icon on Tiny to buy the ship.

Tiny says I need a pilot droid. Where can I find one?



How do I know which droid to buy at Droids-B-Us?



My robot came disassembled. What do I do now?



I bought a droid, but it blew up and killed me!



I've got my droid. Now what?

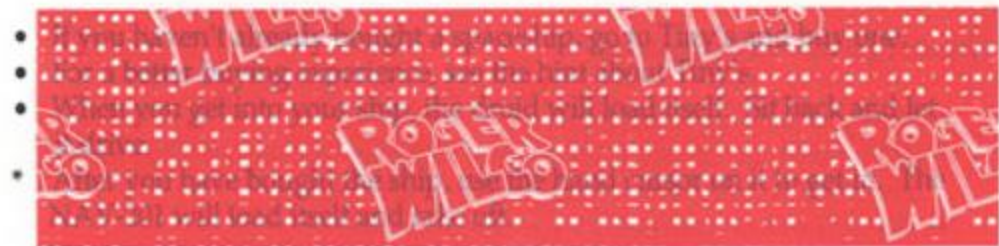

The droid wants to know where I want to go. Where do I want to go?



An early sketch of Roger getting in over his head as usual.

Tiny says I need a pilot droid. Where can I find one?

- Where else? Droids-B-Us!
- The salesbug will show you a selection of his finer used droids.
- Give him your Buckazoids, and you're in business.
- Use the talk cursor on the salesbug to talk to him. Use the eye cursor on the viewscreen to see the descriptions of the available robots. Use the talk cursor on the robot you're interested in to hear a description. Use the Buckazoid cursor on the salesbug to pay him.

How do I know which droid to buy at Droids-B-Us?

- What kind did Tiny tell you to get?
- Get the one the salesbug says is good for piloting a spaceship.
- It's the NAV-201.
- Use the Buckazoid cursor on the salesbug while he's showing the robot of your choice.

My robot came disassembled. What do I do now?

- Well first off, don't try to assemble it.
- This model is dangerous in more ways than one.
- Cut your losses and go play the slots until you have enough to buy another droid.
- This time, buy one that knows how to pilot a ship.

I bought a droid, but it blew up and killed me!

- This is not your lucky day, eh?
- You bought the wrong droid.
- Next time, buy the one that knows how to pilot a ship.

I've got my droid. Now what?

- If you haven't already bought a spaceship, go to Tiny's and buy one.
- For a better buying experience, see the hint about Tiny's.
- When you get into your ship, the droid will load itself. Sit back and let it drive.
- After you have bought the ship, use the hand cursor on it to get in. The NAV-201 will load itself and take off.

The droid wants to know where I want to go. Where do I want to go?

- Remember that conversation you overheard in the Rocket Bar?
- Some guy came across this huge spaceship that was vaporizing a small planet. That sounds like something the Star Generator could do if its power were harnessed for evil.
- Now what was the sector he mentioned seeing the ship in?
- Enter the sector you overheard in the bar into the keypad, using the code from your game documentation.
- When the NAV-201 wants to know your destination, click the hand cursor on the keypad to enter the coordinates you heard in the bar, using the code found in your documentation.



An early sketch of Roger getting in over his head as usual.

The Spaceship Deltaur

How do I get into the big spaceship?

- Go to the airlock and look for the door.
- Turn the handle and pull the door open.
- Push the door open and look for the control panel.
- Press the button on the panel and the door will open.
- Step out into the big spaceship.

I'm in the airlock, and I can't get the inner door to open.

- Look for the control panel on the wall.
- Press the button on the panel and the door will open.
- Step out into the big spaceship.
- Look for the control panel on the wall.
- Press the button on the panel and the door will open.
- Step out into the big spaceship.

I'm in a room with a big trunk. Now what?

- Look for the control panel on the wall.
- Press the button on the panel and the door will open.
- Step out into the big spaceship.
- Look for the control panel on the wall.
- Press the button on the panel and the door will open.
- Step out into the big spaceship.

I got into the air shaft, but now I can't loosen the other vent from this side.

- Look for the control panel on the wall.
- Press the button on the panel and the door will open.
- Step out into the big spaceship.
- Look for the control panel on the wall.
- Press the button on the panel and the door will open.
- Step out into the big spaceship.

No matter where I go, the Sariens keep shooting me.

- Look for the control panel on the wall.
- Press the button on the panel and the door will open.
- Step out into the big spaceship.
- Look for the control panel on the wall.
- Press the button on the panel and the door will open.
- Step out into the big spaceship.

I found where they're keeping the Star Generator, but there's a green guy guarding it. What do I do about him?

- Look for the control panel on the wall.
- Press the button on the panel and the door will open.
- Step out into the big spaceship.
- Look for the control panel on the wall.
- Press the button on the panel and the door will open.
- Step out into the big spaceship.

I found the arsenal, but I can't seem to do anything there.

- Look for the control panel on the wall.
- Press the button on the panel and the door will open.
- Step out into the big spaceship.
- Look for the control panel on the wall.
- Press the button on the panel and the door will open.
- Step out into the big spaceship.

The Spaceship Deltaur

How do I get into the big spaceship?

- Are you wearing your jet pack?
- If you took the second offer on your skimmer at Ulence Flats, you'll have a jet pack to maneuver through space to the Deltaur.
- Fly to the door and look for the control panel.
- It's to the left of the door. Turn the handle and the door will open.
- Use the hand cursor on the door handle to open the door.

I'm in the airlock, and I can't get the inner door to open.

- Be patient, it's all been taken care of.
- In a very short time a cleaning robot will come in and leave the doors open for just a moment.
- If you don't want the robot to sound the alarm and get you killed, hide behind the right side of the doorway where it can't see you.
- To avoid being accidentally electrocuted by the robot, leave *immediately* after the robot comes into the room.

I'm in a room with a big trunk. Now what?

- See that air vent high on the west wall?
- Push the box over to it and climb up on the trunk to reach the air vent.
- Stuck, huh? What do you have that might pry it open?
- Use the knife from your survival kit to pry open the vent.
- An alternate method is to use your knife to pry open the trunk, climb inside and wait for someone to come and move the trunk.
- Use the hand cursor on the trunk to push the box across the room (or the knife cursor on the trunk to open it and the hand cursor on the trunk to climb in). Use the hand cursor on the vent to climb up on the trunk and try the vent. Use the knife cursor on the vent to force it open.

I got into the air shaft, but now I can't loosen the other vent from this side.

- Did you try the knife again?
- Too bad. It won't work.
- Try hitting it.
- Use the hand cursor on the vent to hit it.

No matter where I go, the Sariens keep shooting me.

- It's nothing personal, really.
- They just have to shoot anyone they recognize as an alien. It's their job.
- If they didn't recognize you, they wouldn't be shooting, get it?
- If you had a Sarien uniform, you might be able to pass. There might be some uniforms in the laundry room, huh?
- Go to the laundry room. Get into the washing machine and *voila!*
- The laundry room can be reached through the air vent of the room with the trunk. See the hint about that room.
- Use the hand cursor on the handle of the washing machine to get inside.

I found where they're keeping the Star Generator, but there's a green guy guarding it. What do I do about him?

- You're in a position to drop something on him from up here.
- If you had a gas grenade, you could put him out of commission real quick.
- The gas grenades are in the arsenal, where all the weapons are kept.

I found the arsenal, but I can't seem to do anything there.

- That's because you don't have an I.D. card to prove to the robot in charge that you're a Sarien in good standing.
- There was an I.D. card in the laundry room, but you obviously left without picking it up.
- Look through the stuff that fell out on the floor when you climbed out of the washing machine. You'll find the I.D. there.
- Use the hand cursor on the I.D. card on the laundry room floor to pick it up. Use the I.D. cursor on the arsenal robot to show it to him.

I found the arsenal, but I can't get a gas grenade there.

- You can't get the gas grenade until you've killed the robot.
- You'll need to get the gas grenade when the robot goes to get the fuel. When the robot goes away to get the fuel, you'll have a chance to get the gas grenade and take it to the Star Generator.
- The gas grenade is in the arsenal. You'll find it in the arsenal with the other gas grenades. You'll need to use the gas grenade to get the gas grenade.
- Use the gas grenade to get the gas grenade. You'll need to use the gas grenade to get the gas grenade.
- When the robot goes to get the fuel, you'll have a chance to get the gas grenade. When the robot goes to get the fuel, you'll have a chance to get the gas grenade. You'll need to use the gas grenade to get the gas grenade.

I lost my helmet, and the Sariens are shooting me again.

- Run away.
- Use your PDA.
- Take the helmet and run away. You'll need to run away from the Sariens.

I keep bouncing off the force field around the Star Generator.

- Turn off the force field.
- Use your PDA to turn it off. You'll need to use the PDA to turn it off.
- Maybe the force field is broken.
- Search the arsenal for the force field control. You'll find it in the arsenal.
- Use the force field control to turn off the force field.

How do I set the Star Generator to self-destruct?

- Use the Star Generator to set the Star Generator to self-destruct.
- Use the Star Generator to set the Star Generator to self-destruct.
- Use the Star Generator to set the Star Generator to self-destruct.
- Use the Star Generator to set the Star Generator to self-destruct.
- Use the Star Generator to set the Star Generator to self-destruct.

The self-destruct sequence has started. How do I get out of here before I get blown to bits?

- Run away.
- The Star Generator will explode. You'll need to run away from the Star Generator.
- Use your PDA to turn off the Star Generator.
- Use the Star Generator to set the Star Generator to self-destruct.
- Use the Star Generator to set the Star Generator to self-destruct.

I see a spaceship - now what?

- Run away.
- Use your PDA to turn off the Star Generator.
- Use the Star Generator to set the Star Generator to self-destruct.
- Use the Star Generator to set the Star Generator to self-destruct.
- Use the Star Generator to set the Star Generator to self-destruct.

I found the arsenal, but I can't get a gas grenade there.

- Yes, you can. You just can't get one honestly.
- You'll need to get the gas grenade when the robot goes to get the PulseRay. When the arsenal robot goes away to get your PulseRay, sneak over to the other side of the counter and take one of the gas grenades.
- They're the little round things sitting on a counter on the outside wall of the store room nearest where you're standing. Hurry. Time is of the essence here.
- Don't try to take both of them - you'll waste what little time you have and get yourself shot.
- When the robot leaves the room, use the hand cursor on the left end of the countertop. When you get on the other side, use the hand cursor on one of the gas grenades, then return to this side of the counter and use the hand cursor again to close it. The faster you do this, the less chance you will be vaporized.

I lost my helmet, and the Sariens are shooting me again.

- Shoot back.
- Use your PulseRay.
- Take the PulseRay pistol from your inventory and use its cursor on the Sarien you want to shoot.

I keep bouncing off the force field around the Star Generator.

- Turn it off.
- Oh, you can't reach it to turn it off, can you? If only you had a remote control.
- Maybe the guard has one.
- Search the guard and get his remote control. Aim it at one of the force field emitters. Neat, huh?
- Use the remote control cursor on one of the emitters.

How do I set the Star Generator to self-destruct?

- There's a control panel on the front of the Star Generator pedestal.
- Take a closer look at it.
- Enter the code you got from the data cartridge.
- Start thinking about a way to get off this tub.
- Use the hand or eye cursor on the control panel on the front of the Star Generator to get a close-up view. Use the hand cursor on the keys to enter the code you got from the data cartridge when you read it on Kerona.

The self-destruct sequence has started. How do I get out of here before I get blown to bits?

- You'll need an escape ship.
- The captain has one of these for just such an emergency as this.
- The captain also has a special elevator for getting to the escape ship.
- Remember the elevator outside the laundry room that you couldn't get into earlier? Try it now. Be prepared to shoot the guard to get in.
- Use the PulseRay cursor on the guard to eliminate him. Use the hand cursor on the elevator to open it. When you arrive in the escape pod bay, use the hand cursor on the escape pod to get in and go.

I see a spaceship - now what?

- Get into it.
- The rest is automatic.
- If you've set the star generator to self-destruct and have the data cartridge to give to the scientists back on Xenon, you're ready to go. If not, better restore and fix those little details. Now you're finally going to be a hero. Congratulations.
- Use the hand cursor on the escape pod to get in and go.

Art Designer's sketch of the new look for the Sarien bad guys.

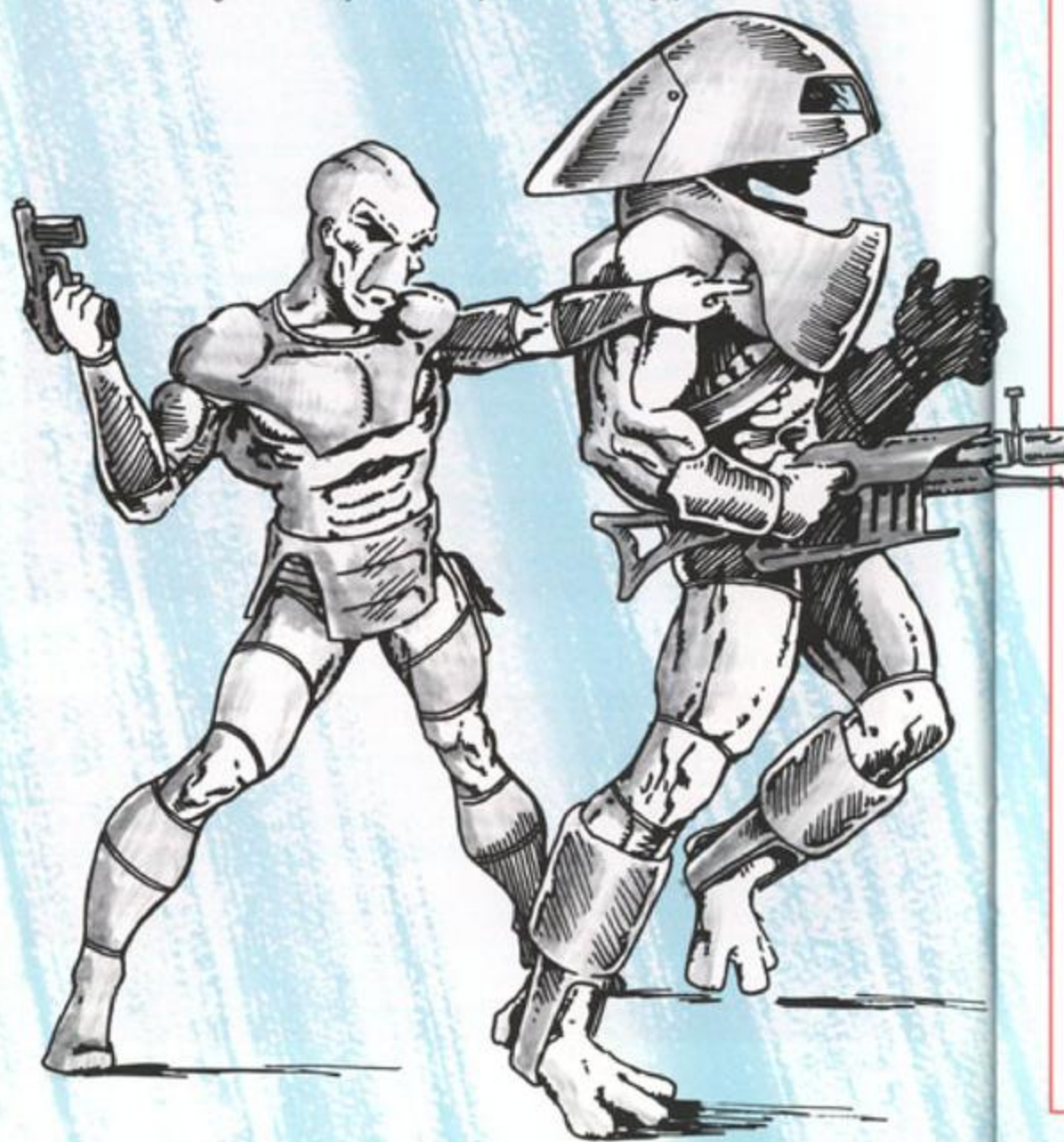

The Spaceship Arcada

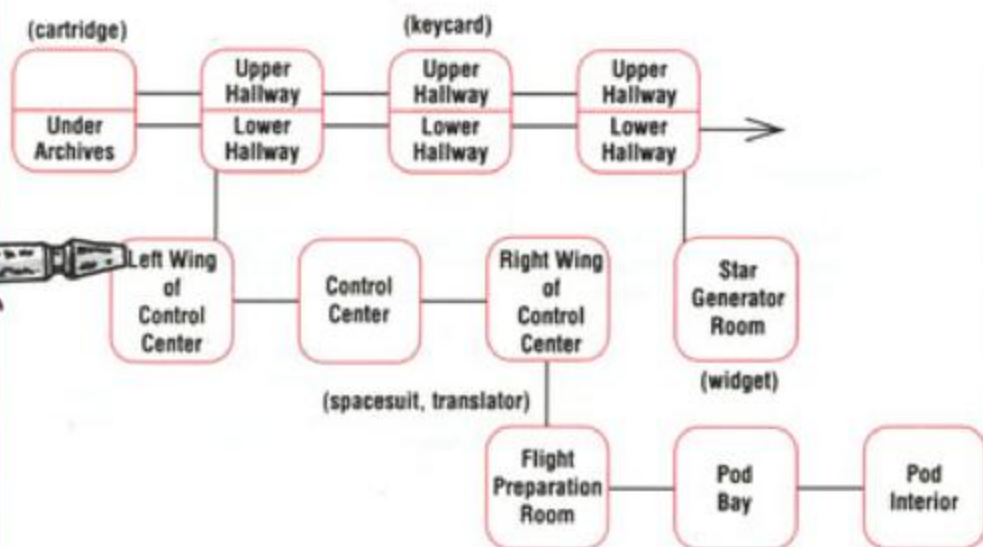

The Planet Of Kerona

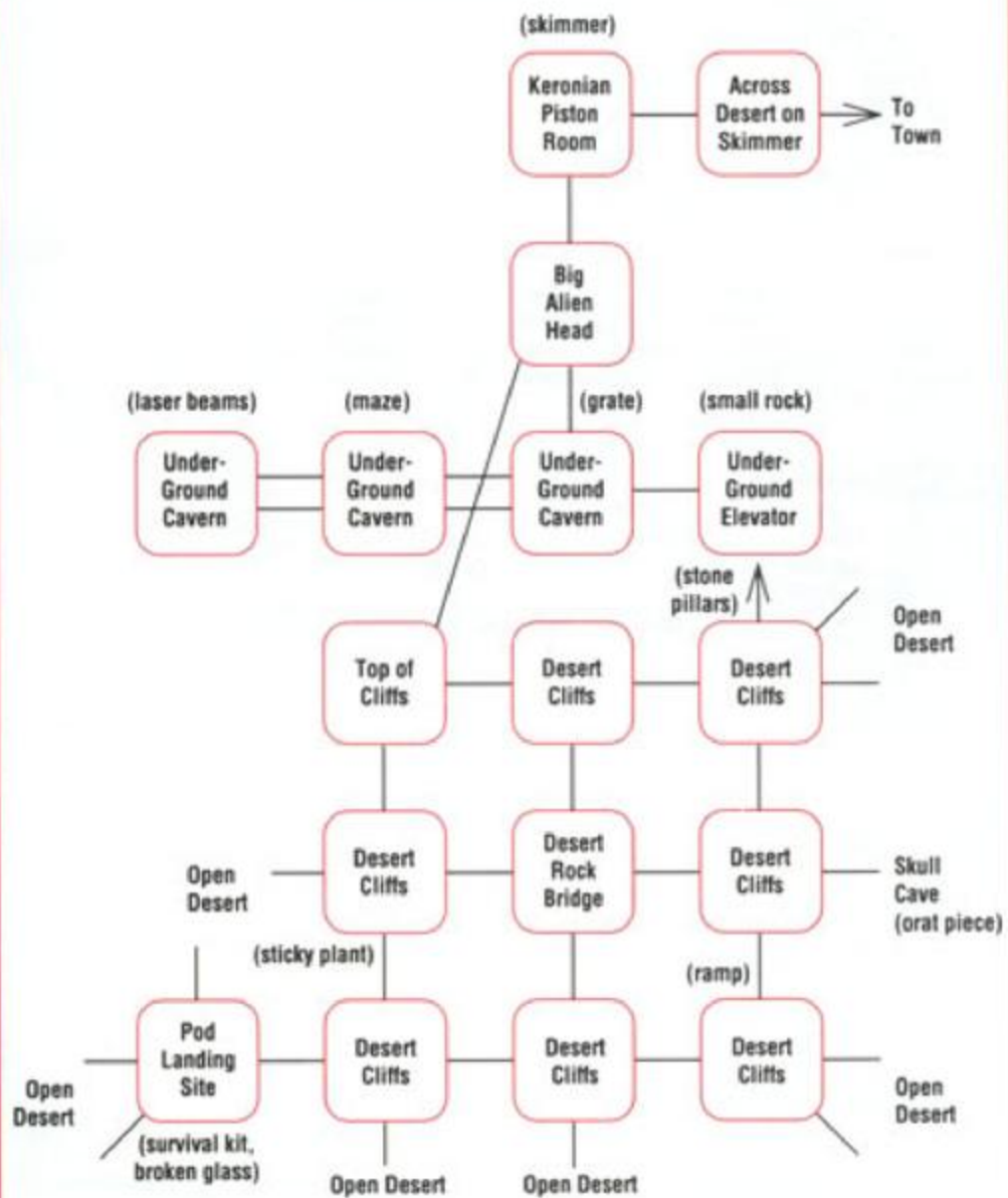

The Town Of Ulence Flats

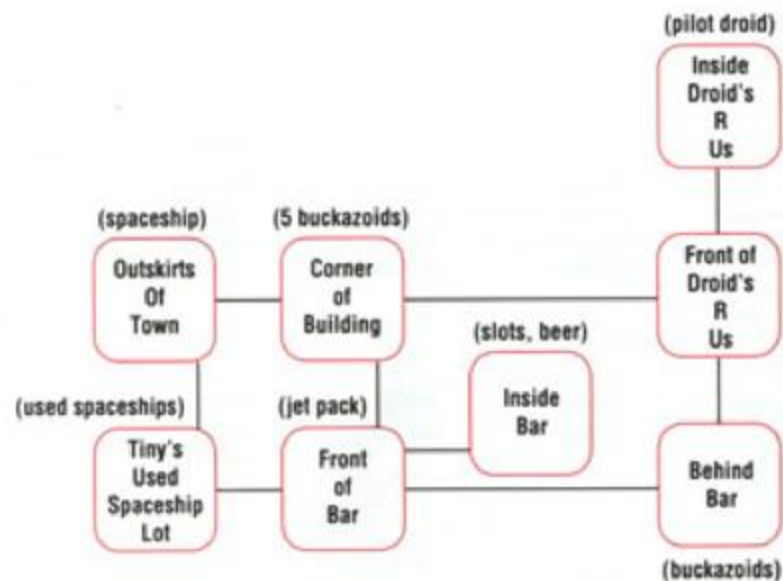

The Spaceship Deltaur

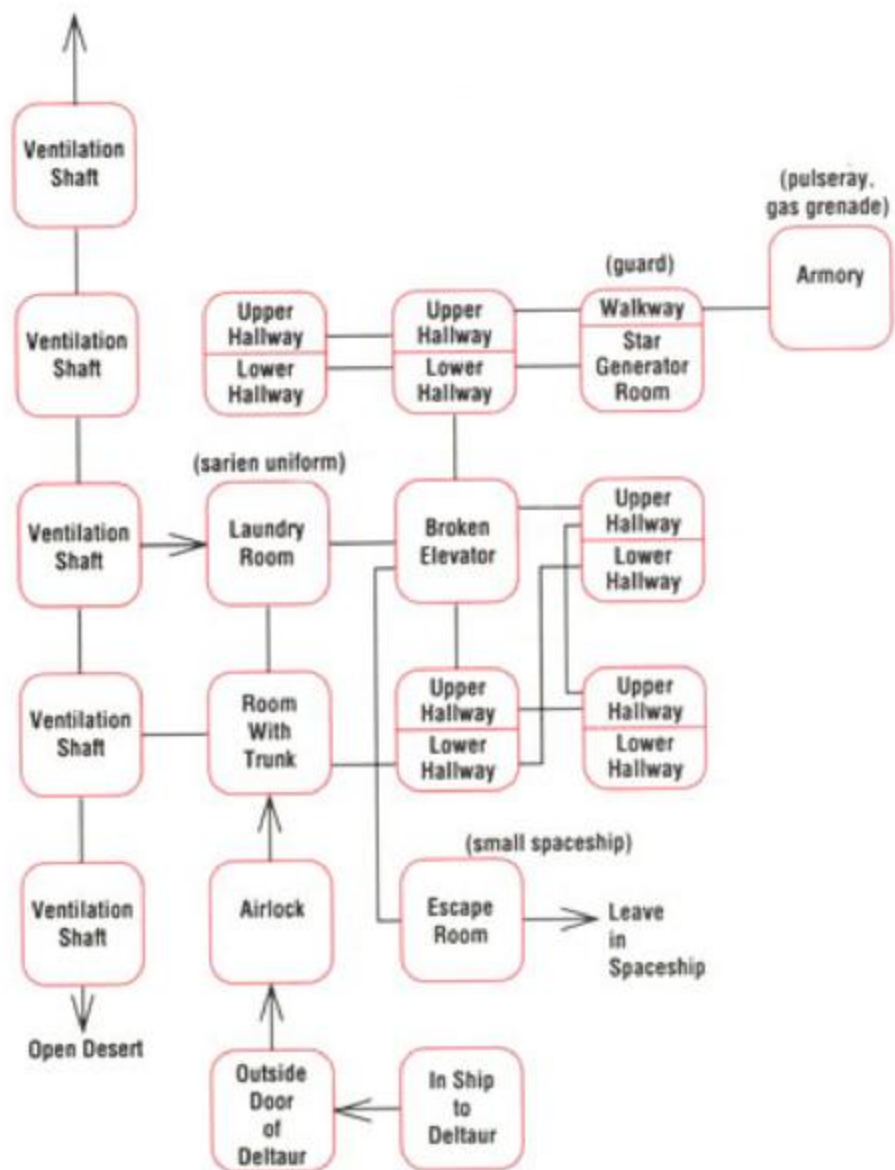

Profile: Roger Wilco

Roger Wilco's career has gone from the depths of the trash compactor to the heights of glory. From humble beginnings as a janitor (junior grade) aboard the research vessel Arcada, Roger has gone on to become one of the most admired figures in the galaxy through his exploits in the *Space Quest* series. He could be considered the ultimate overachiever, having far exceeded any reasonable expectations of his abilities. On the other hand, he might only be the luckiest sucker ever to draw breath.



Profile: The Sariens

The Sariens are the nomads of the galaxy, having buried every living thing on their homeworld under 5000 meters of fast food containers and sweepstakes mail. Without a planet to call their own, and unwelcome on everyone else's, they wander from sector to sector doing dirty deeds for anyone with the buckazoids to hire them. Although the cosmos contains a diverse spectrum of life forms, the Sariens are universally considered among the ugliest and worst-dressed.

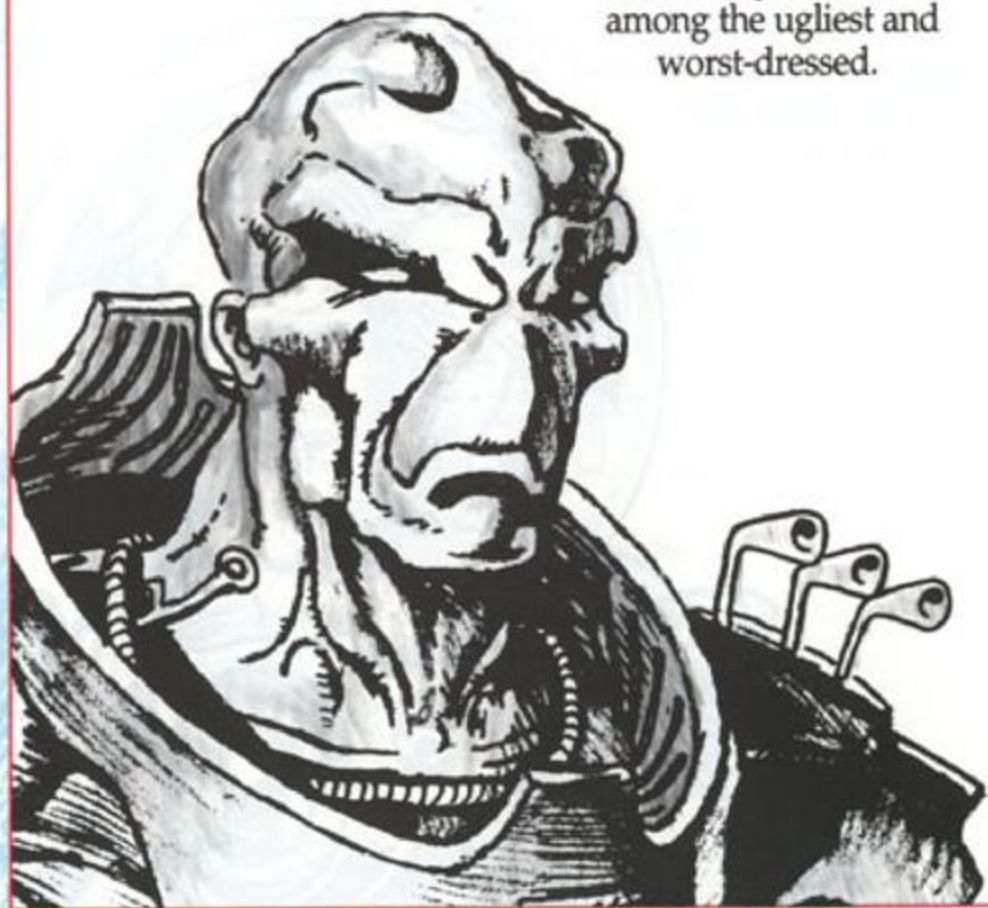

Profile: The Keronians

At first the Keronians appear to have originated in the nightmares of Dr. Seuss, but in fact they are a gentle and studious people, keeping largely to themselves in the smattering of small towns and outposts on the planet Kerona. Legends tell of a vast Keronian civilization beneath the planet's surface, but no outsider has ever reported seeing it. Keronians are extremely suspicious of strangers in general, but there are stories of them rendering aid to lost travelers.



Objects In Space Quest I

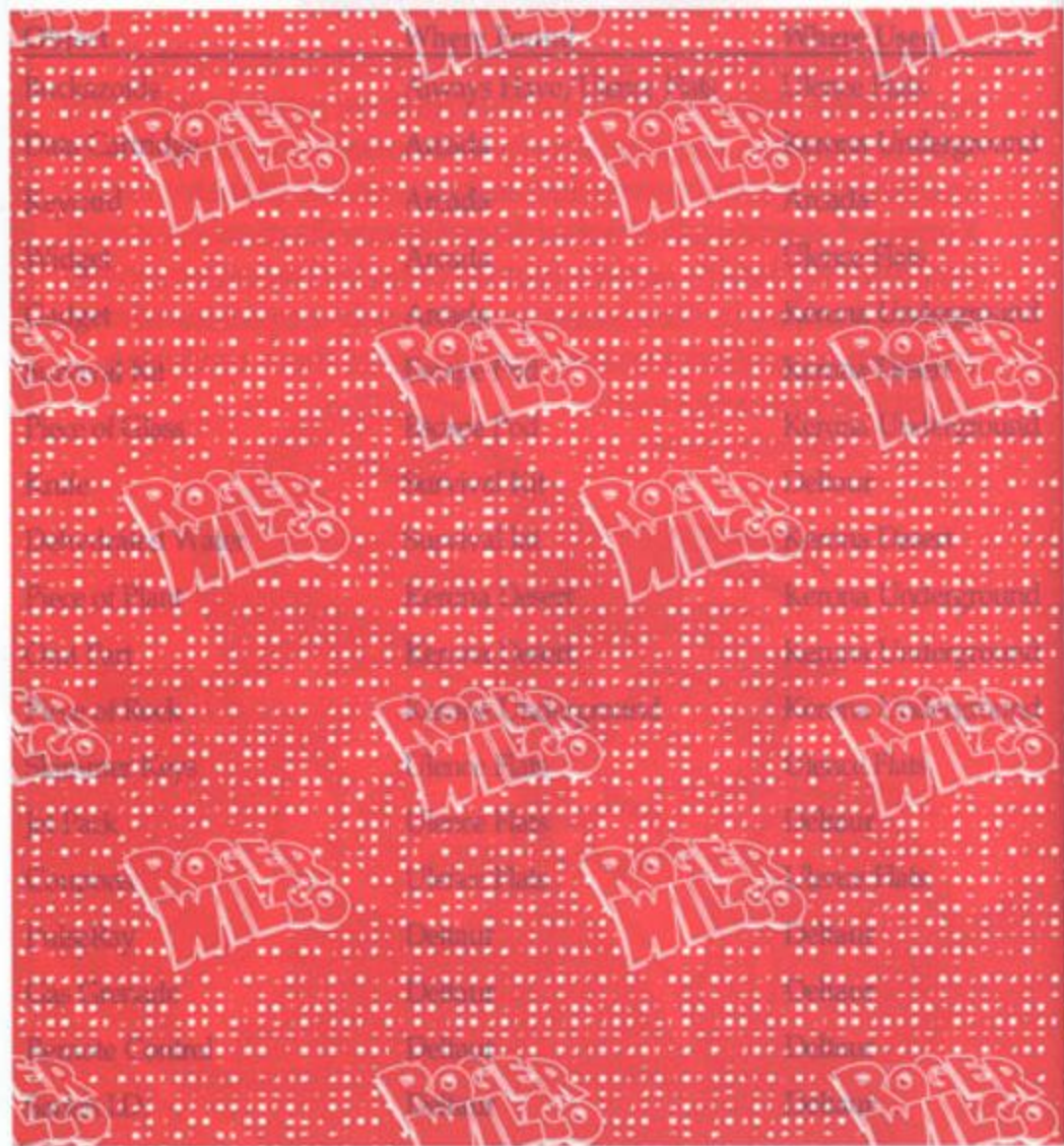

Points List



Objects In Space Quest I

Object	Where Found	Where Used
Buckazoids	Always Have/Ulence Flats	Ulence Flats
Data Cartridge	Arcada	Kerona Underground
Keycard	Arcada	Arcada
Widget	Arcada	Ulence Flats
Gadget	Arcada	Kerona Underground
Survival Kit	Escape Pod	Kerona Desert
Piece of Glass	Escape Pod	Kerona Underground
Knife	Survival Kit	Deltaur
Dehydrated Water	Survival kit	Kerona Desert
Piece of Plant	Kerona Desert	Kerona Underground
Orat Part	Kerona Desert	Kerona Underground
Piece of Rock	Kerona Underground	Kerona Underground
Skimmer Keys	Ulence Flats	Ulence Flats
Jet Pack	Ulence Flats	Deltaur
Coupons	Ulence Flats	Ulence Flats
PulseRay	Deltaur	Deltaur
Gas Grenade	Deltaur	Deltaur
Remote Control	Deltaur	Deltaur
Sarien I.D.	Deltaur	Deltaur

Points List

Item	Points
Find out name of data cartridge	2
Get cartridge	5
Get keycard	1
Get widget	1
Open bay doors	2
Open elevator	2
Get spacesuit	2
Get gadget	2
Escape Arcada	15
Push AutoNav button	2
Get survival kit	2
Get glass	3
Get sticky plant	2
Find secret door to elevator	2
Use plant	5
Open glowing door	4
Disable laser beam	5
Get past acid drops	3
Kill spider droid	5
Kill orat	5
Get orat part	2

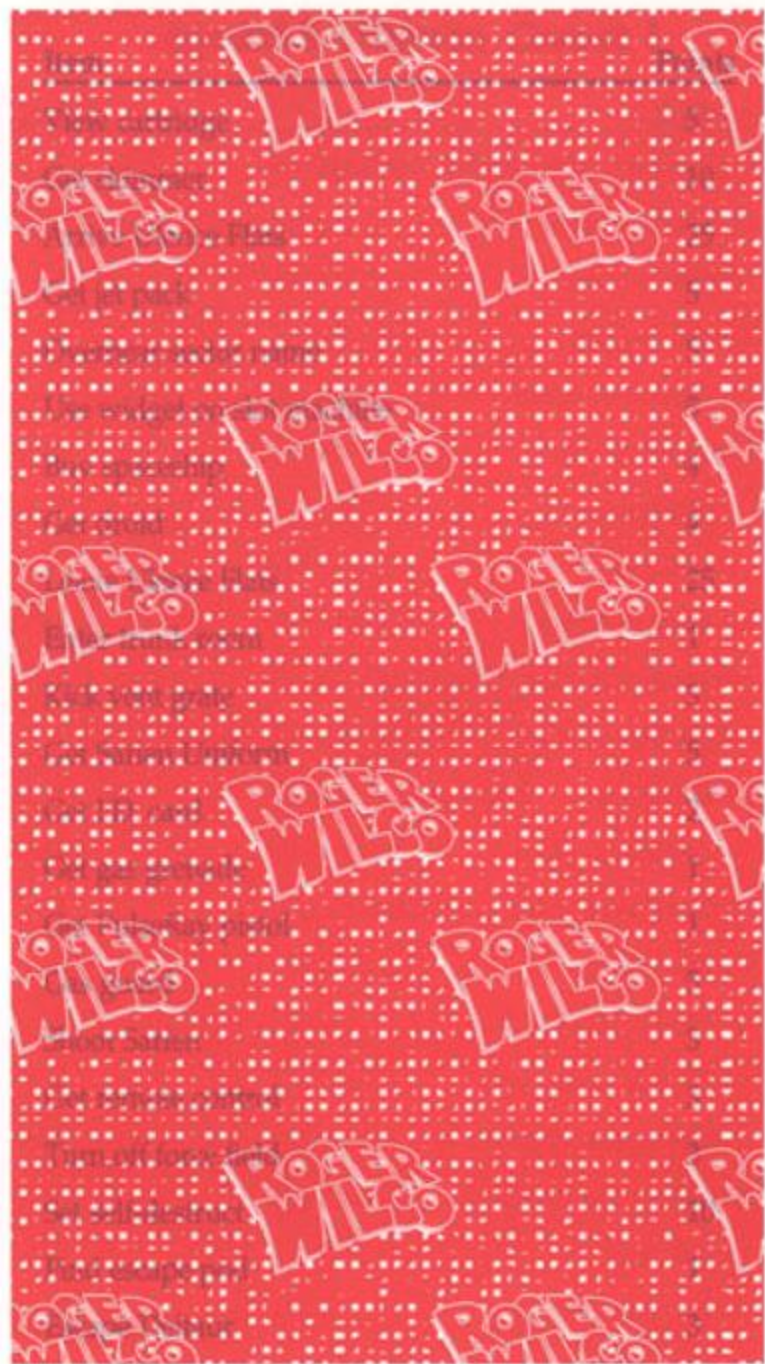

NOTES



Item	Points
View cartridge	5
Get skimmer	10
Arrive Ulence Flats	25
Get jet pack	5
Overhear sector name	5
Use widget on slot machine	5
Buy spaceship	4
Get droid	4
Leave Ulence Flats	25
Enter trunk room	1
Kick vent grate	3
Get Sarien Uniform	5
Get I.D. card	2
Get gas grenade	1
Get PulseRay pistol	1
Gas guard	5
Shoot Sarien	3
Get remote control	3
Turn off force field	3
Set self-destruct	10
Find escape pod	1
Escape Deltaur	3

NOTES



GAME CREDITS

Executive Producer:

Ken Williams

Creative Director:

Bill Davis

Directors:

 Scott Murphy
 Douglas Herring

Producer:

Stuart Moulder

Game Designers:

 Scott Murphy
 Mark Crowe

Art Designer:

Douglas Herring

Lead Programmer:

Jerry Shaw

Composer:

Ken Allen

Animators:

 Douglas Herring
 Vasken Nokhoudian
 Nathan Larsen
 Arturo Sinclair
 Deena Krutak
 Desie Hartman
 Jerry Jessurun
 Russell Truelove
 Diana R. Wilson

Background Artists:

 Douglas Herring
 Nathan Larsen
 Arturo Sinclair
 Eric Kasner
 Willis Wong
 Jay Allen Friedmann
 Jennifer Shontz
 Andy Hoyos
 Jane Cardinal
 Maurice F. Morgan

Programmers:

 Jerry Shaw
 Randy MacNeill
 Dave Jamriska
 Hugh Diedrichs

Music Director:

Mark Siebert

System Development:

 Chris Smith
 Jeff Stephenson
 Robert E. Heitman
 Pablo Ghenis
 Dan Foy
 Larry Scott
 J. Mark Hood
 Mark Wilden
 Eric Hart
 Chad Bye

Sound Effects:

 Ken Allen
 Mark Seibert
 Orpheus Hanley

 Space Quest I theme based
 on the Original Composition by:
 Mark Crowe

Additional Written Material:

 Bridget McKenna
 Gano Haine

Quality Assurance:

Sharon Simmons

Hintbook Design:

Gloria Garland

HINT BOOK ORDER FORM

	PRICE	TOTAL
King's Quest I	9.95	
King's Quest II	9.95	
King's Quest III	9.95	
King's Quest IV	9.95	
King's Quest V	9.95	
Space Quest I	9.95	
Space Quest II	9.95	
Space Quest III	9.95	
Space Quest IV	9.95	
Leisure Suit Larry I	9.95	
Leisure Suit Larry II	9.95	
Leisure Suit Larry III	9.95	
Leisure Suit Larry V	9.95	
Police Quest I	9.95	
Police Quest II	9.95	
Police Quest III	9.95	
Manhunter I	9.95	
Manhunter II	9.95	
Code Name: Iceman	9.95	
Gold Rush!	9.95	
Colonel's Bequest	9.95	
Quest for Glory I (formerly Hero's Quest I)	9.95	
Quest for Glory II	9.95	
Conquests of Camelot	9.95	
Conquests of the Longbow	9.95	
Heart of China	9.95	
Rise of the Dragon	9.95	
The Black Cauldron	9.95	
	Subtotal	
	California residents add 6.5% sales tax. Illinois and Texas add 6.25% Massachusetts residents add 5% sales tax.	Tax
		Total

More ordering information on the following page.

HINT BOOK ORDER FORM

Please Print

Name _____

Address _____

City/State/Zip _____

Phone () _____

Requested for credit card orders; desired for all orders.

Check method of payment (*PLEASE DO NOT SEND CASH*)

Master Card Visa American Express

Discover Card Check Enclosed

Card Number _____

Expiration Date / _____

Authorizing Signature _____

Requested for credit card orders.

Please allow two weeks for delivery.

All prices include shipping and handling.

Make checks payable to:

Sierra On-Line, Inc.

Mail payment with this order to:

Hint Books

Sierra On-Line, Inc.

P.O. Box 485

Coarsegold, CA 93614



©1991 Sierra On-Line, Inc.

000001610



To reveal the **HIDDEN** clues, place the red Adventure Window over the red patterned areas in your hint book so that the dot shows through the hole.



SIERRA[®]
Adventure
Window



SIERRA WARRANTY REGISTRATION
 PO BOX 485
 COARSEGOLD, CA 93614-9850



POSTAGE WILL BE PAID BY ADDRESSEE

BUSINESS REPLY MAIL
 FIRST CLASS MAIL PERMIT NO. 4 COARSEGOLD, CALIFORNIA



NO POSTAGE
 NECESSARY IF
 MAILED IN THE
 UNITED STATES



Win a complete Sierra/Dynamix game library...

Contests, goodies and other free stuff.

You have NOT already won a complete Sierra/Dynamix library. But you could if you send in this card **TODAY!**

Really. Four times a year we have a drawing, and five winners get every Sierra and Dynamix game available for their machine (meaning currently on our retail price list). Yeah, we've never won anything either, but wouldn't it be cool to have a complete Sierra library? Just send in this card to enter.

PLUS FREE STUFF!!!

You'll get **four free issues** of *InterAction*, the magazine of interactive entertainment (an \$11.80 value). We stuff every big, bright, full-color issue with a couple tons of game hints, strategy guides, top secrets, interviews with game designers, special sales, and lots of other warped and wonderful stuff, all designed to amuse, inform, soft-sell our other games and convince the world how unbearably cool it is to work for a computer game company (U.S. and Canada only).



If mailed in the U.S., use the postage paid card. Outside U.S., please place card in envelope and mail.

Last Name _____

First Name _____

Address _____

City/Province _____

State _____ Zip/Postal Code _____

Country _____ Phone # (____) _____

Product Purchased _____ New Address/Change of Address

IF YOU DON'T KNOW AN ANSWER, SIMPLY LEAVE IT BLANK

How many Sierra/Dynamix games do you own? _____

Who is the primary user of these products? (check one)

Male under 20 Male over 20

Female under 20 Female over 20

Do you have children at home? If yes, check all that apply.

Male child under 10 Male child over 10

Female child under 10 Female child over 10

Where did you purchase this product?

Babbage's Egghead Software Etc.

Electronic Boutique Other _____

What type of computer do you own?

(check all that apply)

IBM or compatibles Amiga

Color Macintosh Other _____

Do you have a modem? Yes No

MS-DOS Owners only:

What graphics card do you use?

EGA/Tandy VGA/MCGA Other _____

Do you own?

MT-32 or LAPC-1 AdLib or Sound Blaster

ProAudio Spectrum Thunder Board

CD ROM Drive Windows™

3.5" Disk Drive 5.25" Disk Drive



**ALL NEW
FORMAT!**

HINT BOOK



If you're playing Sierra's 3-D Animated Adventure Games without a Hint Book, you might be missing half the fun!

Sierra Hint Books are the perfect gaming companion. Each Hint Book contains a helpful walk-through, area maps, a points list, a list of needed items, solutions to all puzzles, even a section to tell you about areas you may have missed.

Best of all, Sierra's Adventure Window lets you reveal only the hints you want (all other information remains concealed).

Includes:

- ***A 'points list' -- find all the needed game points!***
- ***An 'objects needed' list -- find out what items you'll need, why you'll need them and where to find each one!***
- ***A list of 'just for fun' activities -- even if you've completed the game, you may have missed some amusing moments!***
- ***A new format with Sierra's Adventure Window -- your family can use the Hint Book again and again!***