

THE 25TH CENTURY™

# BUCK ROGERS™

COUNTDOWN TO DOOMSDAY  
**CLUE BOOK**

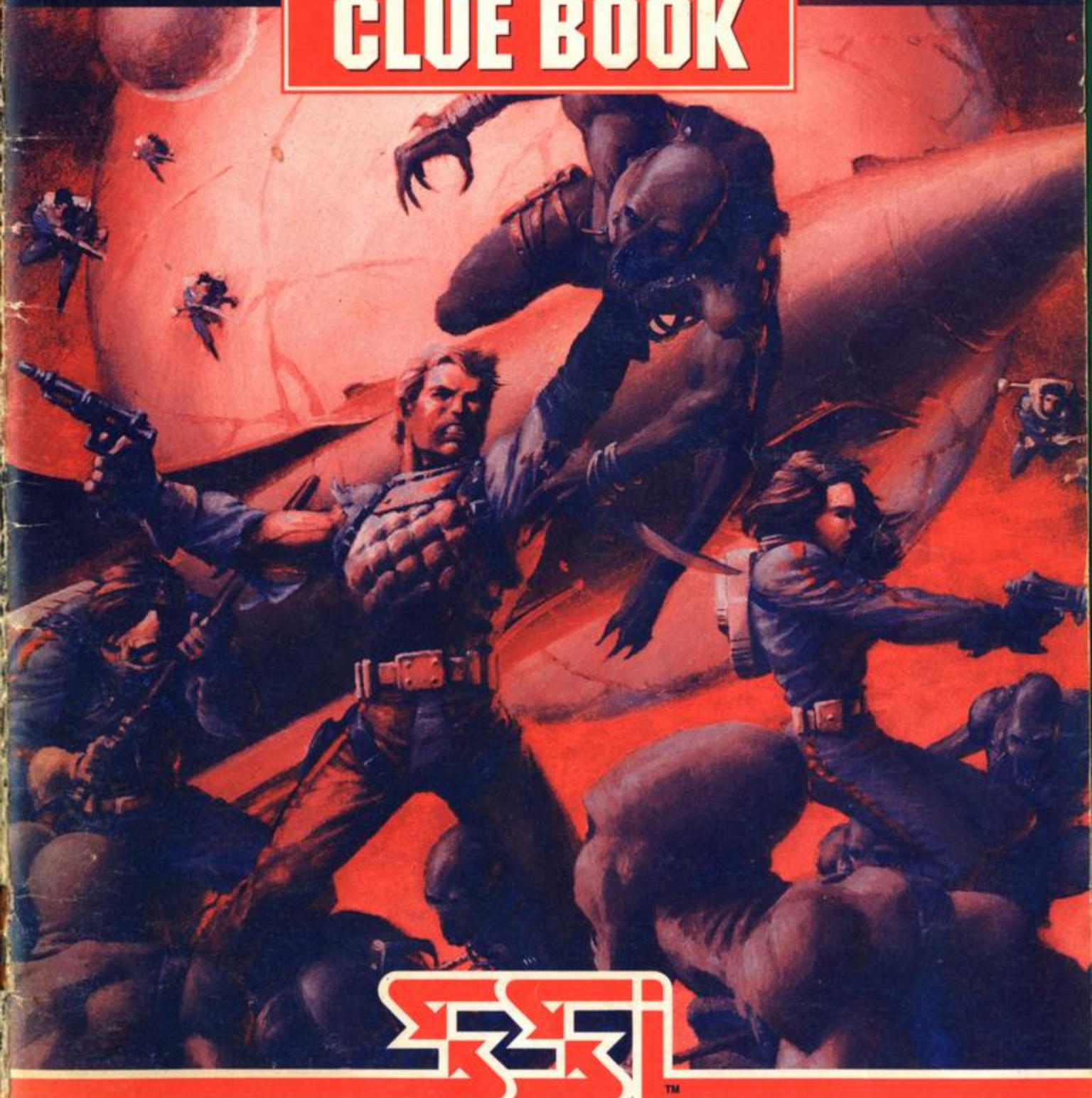

STRATEGIC SIMULATIONS, INC.®

---

# CREDITS

Written by

**Dave Shelley, Rhonda Gilbert,  
Ken Humphries & Ken Eklund**

Art, Graphic Design and Desktop Publishing

**LOUIS SAEKOW DESIGN: Peter Gascoyne**

Printing

**A&a Printers and Lithographers**

---

Strategic Simulations, Inc. reserves the right to make improvements in the product described in this clue book at any time and without notice.

Strategic Simulations, Inc. makes no warranties, express or implied, with respect to this clue book, its quality, merchantability or fitness for any particular purpose. This clue book is provided "as is."

BUCK ROGERS and XXVc are trademarks used under license from The Dille Family Trust.

The TSR logo is a trademark owned by and used under license from TSR, Inc., Lake Geneva, WI, USA.

Copyright 1990 The Dille Family Trust. Copyright 1990 TSR, Inc. Copyright 1990 Strategic Simulations, Inc. All Rights Reserved.

This clue book is copyrighted and includes proprietary information belonging to TSR, Inc. and Strategic Simulations, Inc. No one is permitted to sell copies of this clue book to any person or institution except as provided for by written agreement with Strategic Simulations, Inc. and TSR, Inc. No one may copy, photocopy, reproduce, translate, or reduce to machine readable form this clue book without the prior written consent of TSR, Inc.

Any persons reproducing any portion of this clue book for any reason, in any media, shall be guilty of copyright violation and subject to the appropriate civil or criminal action at the discretion of the copyright holder(s).

# TABLE OF CONTENTS

Introduction .....	1
Getting Help .....	1
Cast of Characters .....	2
Space .....	4
The Story .....	5
Skills .....	7
Maps .....	8
A. Chicagorg .....	9
Salvation .....	10
B. Spyship .....	11
C. Asteroid Base Level One .....	15
D. Asteroid Base Level Two .....	17
E. Pirate Ship .....	19
F. Mars Wilderness .....	23
G. Desert Runner Village .....	24
H. Mars Base Gradivus Mons .....	25
I. Venus Wilderness .....	27
J. Lowlander Village .....	28
K. Venusian Space Elevator Ruins .....	30
L. Venus RAM Base .....	31
M. Mercury Merchant's Area .....	34
N. Mariposa Core .....	35
O. Mercurian Finale .....	38
Monsters: How to Deal with Them .....	41
Ship Combat Tactics .....	43
Tactical Combat Tactics .....	43
Log Entries: True or False? .....	43



## INTRODUCTION

COUNTDOWN TO DOOMSDAY is Strategic Simulations, Inc.'s first BUCK ROGERS™ XXVc™ computer role-playing game. RAM (Russo-American Mercantile) is building a device that will sterilize the Earth. Your characters must locate and destroy the device before it can be unleashed against Earth.

## GETTING HELP

The section **Enemies: How to Deal with Them** contains techniques for defeating all of your opponents in the game. **The Story** gives a brief overview of the game and how to proceed. Following the story are maps and detailed descriptions of the encounters. These include specific suggestions on the best way to get through difficult portions of the game.

NOTE: If you find combat encounters too difficult or too easy, you can adjust them by using the LEVEL command (play level) found under the CHANGE menu.

## CAST OF CHARACTERS



### BUCK ROGERS

Hero of the 20th and 25th century, and top agent of the New Earth Organization (NEO).



### WILMA DEERING

Another of NEO's top agents, and a close friend of Buck Rogers.



### CARLTON TURABIAN

The team's commanding officer in NEO.



### SCOT. DOS

A digital personality who defected from RAM, and provides immeasurable aid to the team.



### TUSKON

A desert runner tribal leader; Tuskon shares the team's desire to fight RAM.



### ATHA

Tuskon's wife.



### DR. WILLIAMS

A RAM scientist destroyed by his own creations.



### ACID FROG

Semi-intelligent creatures who will protect the team if befriended.



### LEANDER

A Lowlander warrior whose people have been murdered by RAM.



### ZANE

A Lowlander child looking for his father.



### TALON

A rogue pirate sometimes employed by RAM.



### TERRINE WARRIOR

Dangerous RAM agents dedicated to the destruction of NEO.



### SUN KING

The demented ruler of the Mercurian Mariposa III.



### STAGE II EXPERIMENTAL COMBAT GENNIE

One of Dr. Williams' deadly experiments.



### URSADDER

The swamps of Venus house many mysterious creatures.



### DOOMSDAY LASER

The team's deadliest enemy is not a living creature.

## AN ATLAS OF THE SOLAR SYSTEM

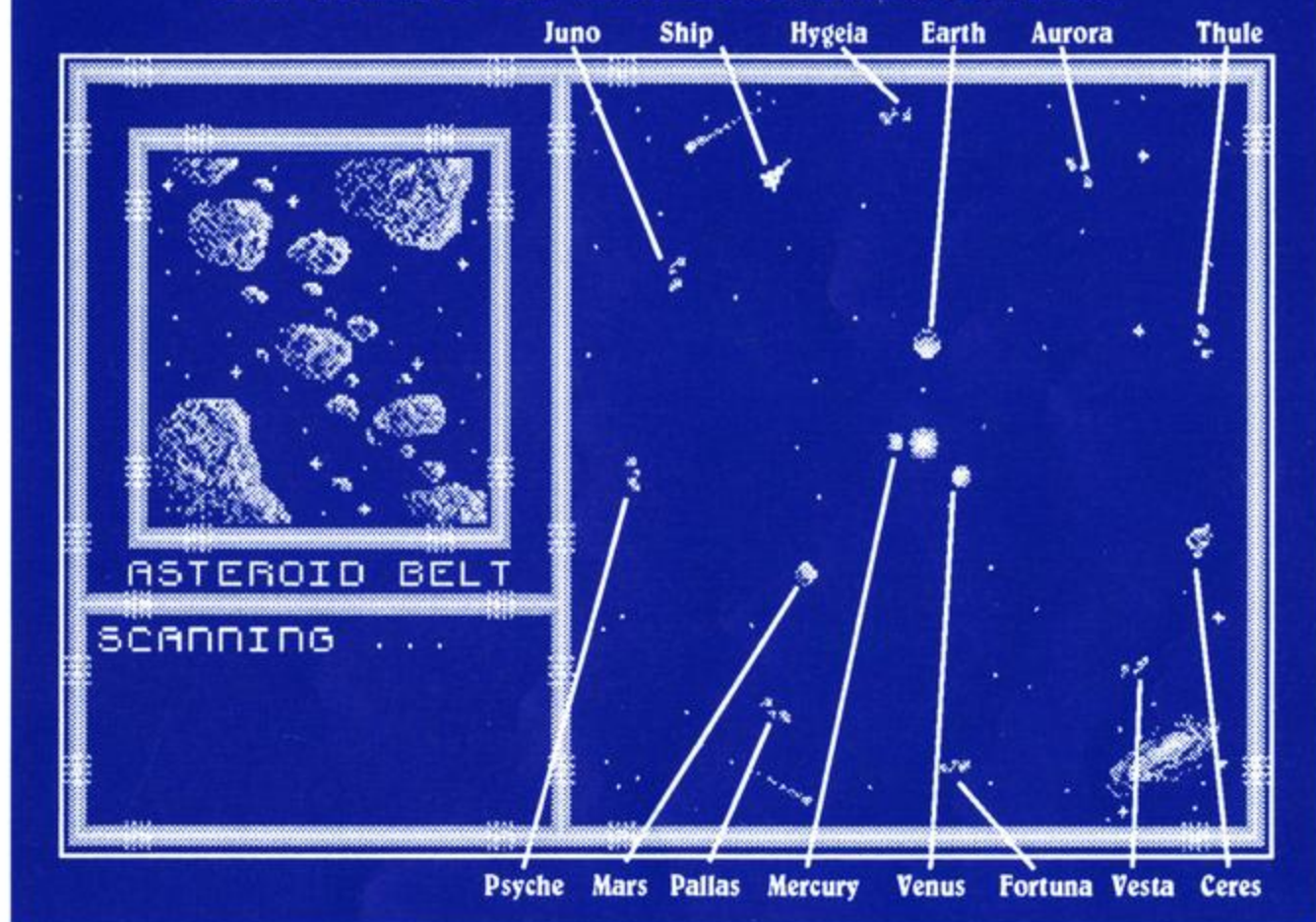

### SPACE

When travelling through space, be sure to have a Rocket Jock with good Pilot Rocket Skill and an Engineer with all the Repair Skills. If the team's ship has been damaged, try to flee any new space combats. See the section Ship Combat Tactics for hints on how to defeat enemy ships.

Make a point of travelling to, and exploring, each of the outposts, located on every planet and asteroid. A number of small adventures can be found by visiting all the areas in each outpost. Some of these events will lead to valuable items.

**Mercury:** The Mercurians derive their wealth from these solar collecting satellites known as Mariposas.

**Venus:** The thick acid jungles of Venus make survival an open question.

**Earth:** The birthplace of heroes and the solar system's shining jewel.

**Mars:** The harsh desert world is home to NEO's enemy, RAM. *PAVONIS*

**Ceres:** Largest of the asteroids. RAM's asteroid base is located nearby.

**Thule:** The asteroids' prison. NEO sympathizers are occasionally condemned to imprisonment here.

**Aurora:** The gambling planetoid. Talon is rumored to have a secret base nearby.

**Hygeia:** A minor asteroid. RAM may have a surveillance base nearby.

**Juno:** Unremarkable, except for the existence of a training center.

**Psyche:** A major shipyard.

**Pallas:** An isolationist planetoid. Many small mining concerns dot the nearby asteroids.

**Fortuna:** A planetoid rumored to sell valuable weaponry.

*VESTA: SHOP + HOSPITAL (2420)*

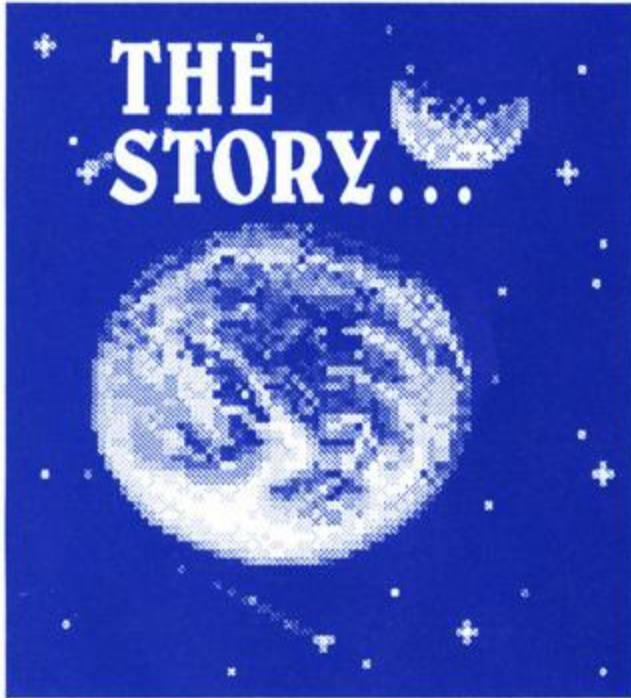

The events in **COUNTDOWN TO DOOMSDAY** can occur in whatever order a player wishes, depending on how he plays. However, the following order is recommended.

The adventure begins in Chicagorg, where the team has recently joined NEO. As the team arrives for its induction, the NEO base is attacked by RAM troops and saboteurs who disable the anti-spacecraft missile system. The team must activate the manual control console to save the base. A RAM technician throws a grenade under the console. One character must throw himself over the grenade to muffle the explosion. After the base is saved the team is assigned to salvage duty at the secret NEO base, Salvation. Soon the characters discover a derelict RAM spacecraft.

On board is evidence of a terrible battle. While the characters are exploring the derelict, their ship is destroyed by an automatic weapon system, trapping them. The team meets Scot.dos, a RAM scientific program. Scot.dos developed ethical problems with RAM's policies and wants to defect to NEO. Scot.dos 'joins' the team as an advisor.

The crew of the ship was killed by ECGs (Experimental Combat Gennies), which mature into steadily more dangerous stages. The ECGs are quickly developing into their third stage, when they will be capable of terrorizing the Earth. The team discovers that the gennies were genetically engineered to be susceptible to argon. The team locates some argon canisters and hooks them into the ventilation system to poison the ECGs. Scot.dos tells the characters that the ECGs were developed on a RAM asteroid base, so they go to investigate.

In the Asteroid Base the team finds information about three RAM projects in development: the ECGs; a deadly laser which, with a large enough lens, would become a Doomsday Laser of immense power; and a set of satellite laser reflectors designed to focus the laser onto individual cities of a planet. The team destroys the satellites and gains information about a test laser currently located on Mars.

Leaving the Asteroid Base, the team is captured by Talon, a rogue pirate employed by RAM to place the laser reflectors around Earth. Talon challenges one character to a duel and is almost certain to be victorious. He then intends to sell the team to RAM. Fortunately, Buck Rogers intervenes. Buck is on Talon's ship following a rumor that the pirate works for RAM. Buck joins the characters long enough to help them disable and escape the pirate ship.

The team then heads for Mars. On Mars the characters find evidence of the test laser, a miniature version of the real Doomsday



Laser. The team finds out that a nearby Desert Runner village is about to be attacked by RAM. The laser has already annihilated several villages, and RAM intends to leave no witnesses.

The Desert Runner leader, Tuskon, joins the team and the characters help the Desert Runners evacuate the village before RAM arrives. Tuskon then leads them to the RAM base where the test laser is housed. They fight their way to the top of the base, and destroy the test laser. In the base the characters find out that RAM is working on Venus to create a lens for the full-sized Doomsday Laser. They also find a set of blue RAM Techniki passes.

In the Venusian acid swamp the team meets a group of Lowlanders who say that they've been betrayed by RAM. One of them, Leander, joins the team. The characters go to a nearby Lowlander village, but find most of its denizens slaughtered. Survivors claim that the raid had something to do with the lens they manufactured for RAM. A Lowlander child joins the team, searching for his father.

The team discovers a subterranean RAM glider hangar near the village. RAM intends to use the gliders to bomb the remaining Lowlander villages. RAM would then control the production of Gravitol, a drug required for space travel. The team destroys the gliders with explosives.

A tunnel in the hangar leads to a RAM base. The team finds a group of captive Lowlander scientists, imprisoned by RAM after the lens was completed. The Lowlander child's father, Landon, escaped. He's searching for a secret exit rumored to be in the base. The characters reunite the child with Landon, and help free the scientists. Landon rewards them with a RAM Retinal Lockpick.

The team travels to the third Mercurian Mariposa (a solar collecting satellite), home of the Doomsday Laser. When the charac-

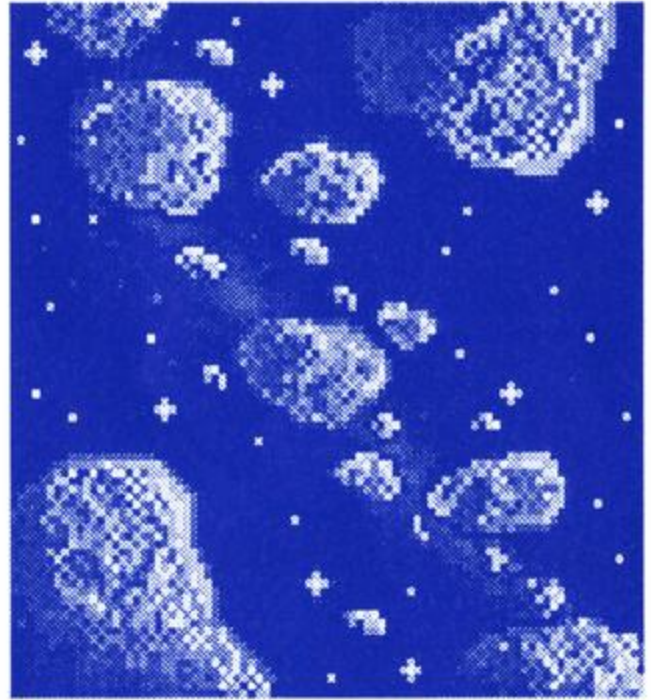

ters arrive, they meet Wilma Deering. She instructs them to sneak up the center core of the Mariposa to the Doomsday Laser.

Minions of the Mariposa's Sun King mistake the team for a group of Desert Dancers assigned to steal control of the Doomsday Laser for the King. The characters play along, pretending to be the Desert Dancers, and the Sun King disables the security system in the core so they can proceed.

At the top of the core, the team discovers that the Doomsday Laser is already counting down to the destruction of Earth. The characters cause a power outage to stall the countdown, then activate the self-destruct mechanism. With RAM warriors and minions of the Sun King now in pursuit, they escape the Mariposa just in time to watch the Doomsday Laser explode.

## SKILLS

### • ALL Characters Should Develop:

**Maneuver in Zero-G:** This is an individual skill roll that will be called every time a character fights a combat in Zero-G.

**First Aid:** Needed to patch up dying characters during combat.

### • At Least One Character Should Develop:

**Battle Tactics:** If one character succeeds in this skill roll in combat, it will benefit the whole team.

**Leadership:** Allows the team to control allies.

**Pilot Rocket:** You won't get far without this one!

**All Medic Skills** (except for Life Suspension and Treat Disease.) Diagnose only requires 15 points to be effective. Most points should go into Treat Light/Serious/Critical Wounds and Treat Poison.

**All Repair Skills:** Keeps the ship flying between battles.

### • Skills Required by Game Area:

**Chicagorg:** None

**Salvation:** None

**RAM Spy Ship:** Repair Electrical, Notice, Programming, Treat Poison, Maneuver in Zero-G

**RAM Asteroid Base:** Programming, Fast Talk/Convince, Bypass Security, Open Lock, Demolitions, Notice

**Pirate Cruiser:** Bypass Security, Open Lock, Demolitions, Sensor Ops, Notice

**Mars Wilderness:** Notice, Planetology, Disguise, Etiquette, Planetary Survival

**Desert Runner Village:** Notice

**RAM Mars Base:** Programming, Demolitions, Climbing, Bypass Security, Open Locks, Library Search

**Venus Lowlander Wilderness:** Befriend Animal, Hide in Shadows

**Venus Lowlander Village:** Pick Pocket

**Venus Ruins:** Climb, Acrobatics

**Venus RAM Base:** Intimidate

**Mercury Mariposa Base:** Disguise, Befriend Animal, Acrobatics, Intimidate, Fast Talk

**Mercury Mariposa Core:** Pick Pocket, Bypass Security, Maneuver in Zero-G

**Mercury Mariposa Top:** Repair Electrical, Demolitions

### • Also:

**Outposts:** Library Search, Hide in Shadows, Sing, Shadowing, Fast Talk/Convince, Notice, Pick Pocket

**Space:** Pilot Rocket, Navigation, Astrogration, Astronomy, Sensor Ops



## A. CHICAGORG

**Synopsis:** The characters have decided to join NEO (New Earth Organization.) They complete their orientation at Chicagorg and as they are marched to the waiting shuttles, RAM launches a surprise attack on the spaceport. The team discovers that RAM has sabotaged the anti-ship missile system. The characters must fight their way to the manual controls and prevent a RAM technician from aiming the missiles at Chicagorg.

**Random Encounters:** Patrols of Terrines are swarming over the port. Often the team will find NEO warriors to aid it. If the characters remain outside for too long, RAM ships will strafe them.

### Locations

- 1: Beyond this point, the bombing makes it too dangerous to proceed. The team will be forced back by the fierce heat.
- 2: The team is here when the attack begins.
- 3: This is the fuel monitor room. The consoles show that the fuel lines have been cut.
- 4: This is a maintenance building where Terrines slaughtered some workers.
- 5: The bombed-out remains of the fire station.
- 6: The lecture hall where the team attended its orientation.
- 7: The canteen where Terrines are killing the wounded. They will turn and attack the team.
- 8: This is the officer's lounge, which has been bombed.
- 9: A wounded officer is here amongst a squad of dead Terrines. He will tell the team about the manual missile controls.
- 10: A Terrine is waiting in ambush in the women's rest room.
- 11: The exit gates are sealed. The team cannot leave the port.
- 12: This is the bombed-out waiting room.
- 13: This is the medical center which is full of wounded warriors. As the team leaves this room, a booby-trapped body detonates and slays most of the wounded.
- 14: If the team tries to enter the building through this door, it will have to fight a squad of Terrines.
- 15: This is the missile control room. Upon entering the room, the team must defeat a squad of Terrines. After this, the characters will spot a technician re-programming the missiles to fire on Chicagorg.

The team should charge the technician and overcome him. He will then try to destroy the controls with a grenade. Someone with good hit points should fall on the grenade. If no one does, the controls will be destroyed and RAM will be able to finish off the port.

## A. CHICAGORG



### KEY

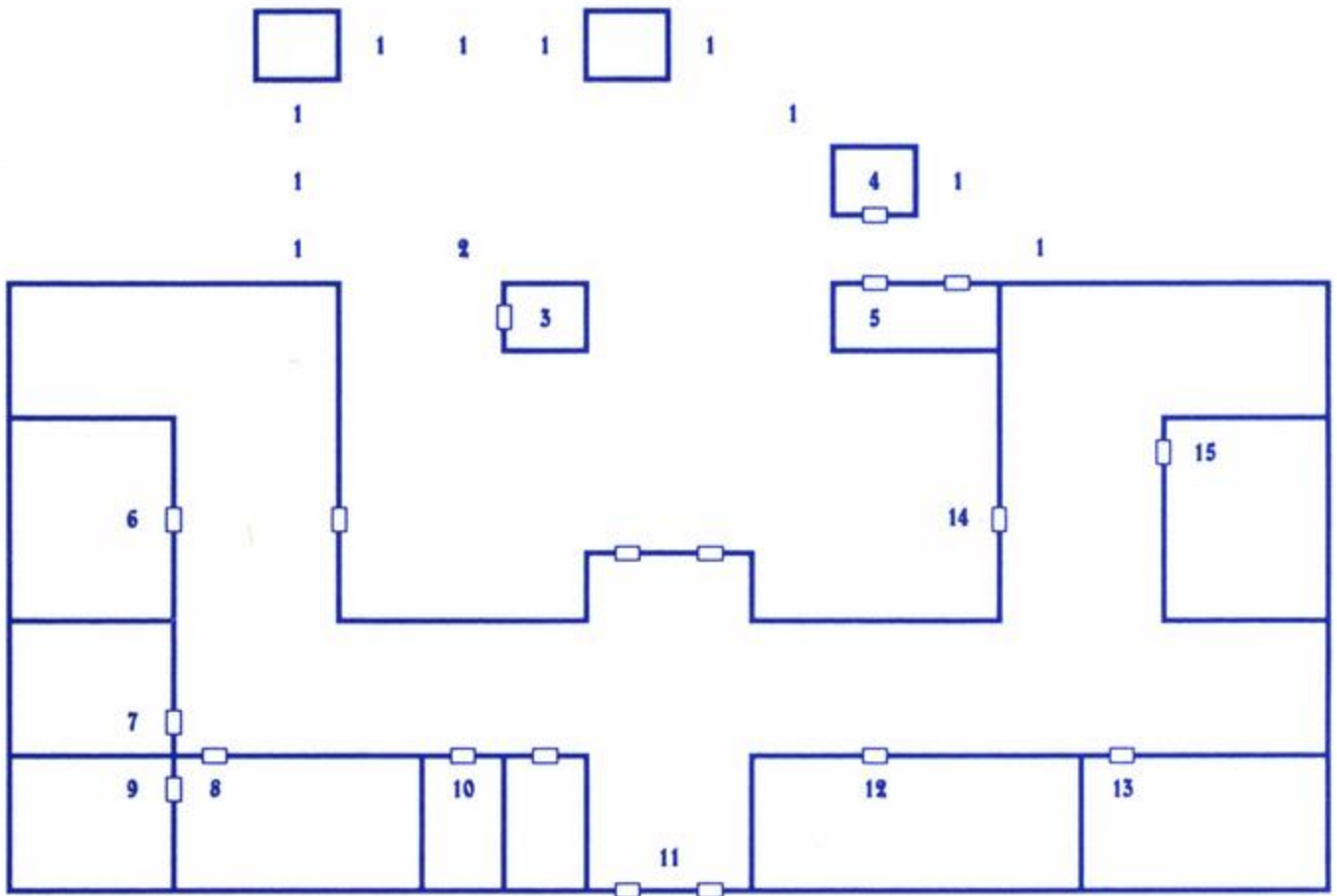

## SALVATION

Salvation is the secret NEO base in orbit around Earth. From here the team can gain information about where to go next. Also, the hospital and repair facilities are free here.



## B. SPYSHIP

**Synopsis:** The team is on a salvage mission when it comes across a derelict spaceship. The team docks and discovers signs of a battle. A hologram of Dr. Alexander Williams appears screaming and disappears through a wall. Immediately thereafter, the ship's security program will destroy the team's tug.

The characters will explore the ship and uncover the existence of Experimental Combat Gennies (ECGs) which RAM hopes to seed onto the Earth. The creatures escaped while Scot.dos and the security program were fighting for control of the computer.

Scot.dos is a digital personality who believes that Earth's diverse ecosystem is worthy of protection. He tried to seize the ship and abort the plans to destroy the planet.

The team must discover the weaknesses of the ECGs and destroy them. Once the team is victorious, it will gain the ship for its own.

**Random Encounters:** As the team explores, it will meet defense robots and different stages of ECGs. The robots consider the ECGs to be RAM property and thus under their protection. The characters will discover a more subtle threat as well. The ECGs shed a brain parasite, which burrows through clothing and flesh until it reaches the brain. Once there, it causes madness and coma.

The brain parasites are too small to defend against. The characters must locate the sick bay (Level 6, location 23) to cure themselves and create a protective salve.

## Locations

**A:** This is an airshaft. The team has a chance to notice an entrance into the ducts. Once the characters discover this, they can travel up and down between decks one and nine.

Due to the narrowness of the shaft, the team must travel in single file. ECGs frequent the shaft and the front and rear characters may find themselves in combat alone.

- 1:** Many useless odds and ends float about here. Once the team is aware that argon gas can defeat the ECGs, it will find two gas canisters here.
- 2:** Ladder to location 3.
- 3:** Ladder to location 2.
- 4:** The main engineering controls are here. The engines are shut down and can only be restarted when the ship is secured.  
  
This is where the air flow can be restored when the ECGs isolate the control room. The ECGs will detect the team's work and send a horde against it. The characters must hold their ground since the ECG force is too large to overcome.
- 5:** Ladder up to location 6.
- 6:** Ladder down to location 5 and up to location 10.
- 7:** These are the turret controls. They are under computer control.
- 8:** This is where the characters enter the ship. The airlock behind them is damaged when the computer destroys their ship.
- 9:** The ECGs escaped from these biolabs. The remains of Dr. Williams are floating here. He was slain while trying to ready a holographic warning. Only his death was recorded.
- 10:** Ladder down to location 5 and up to location 15.
- 11:** This is the seemingly peaceful hydroponics garden. If the team ventures deeper into the room, it will be overcome by a mysterious lassitude. A fourth stage ECG lures humans into its

**B. SPYSHIP**

## Level 1 — Engineering

## Level 0 — Storage

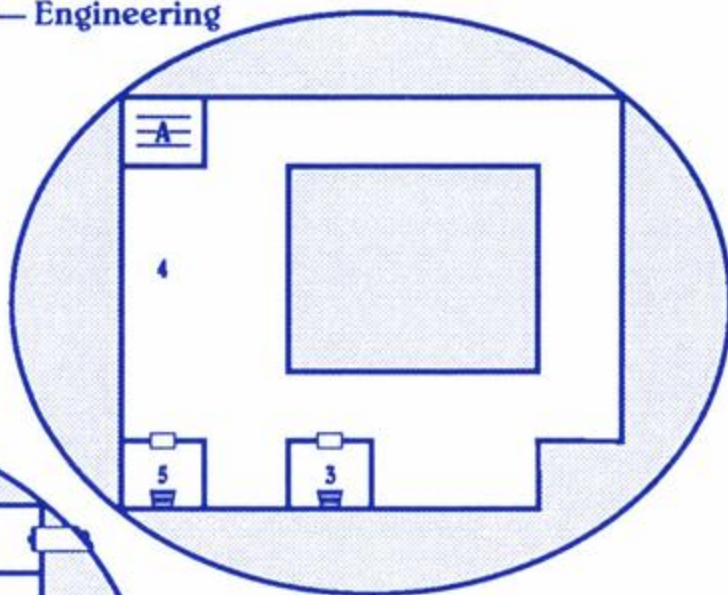
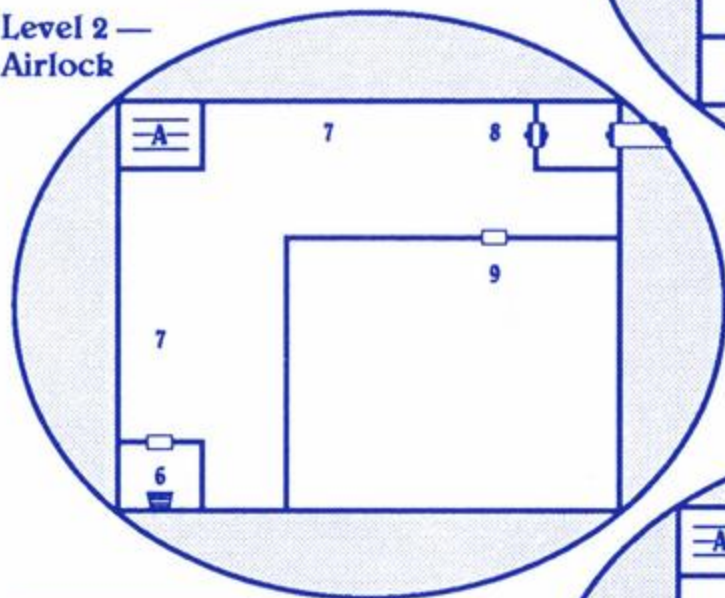
Level 2 —  
Airlock

## Level 3 — Life Support

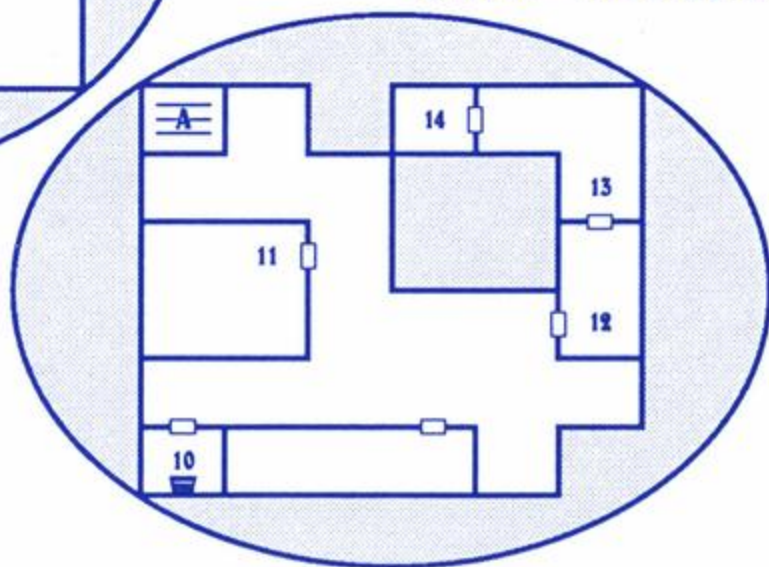
**KEY**

	Wall
	Door
	Ladder
	Air Duct
	Airlock
	Impassable/ Hull

embrace by scent and sound cues. If the team struggles it can survive with minimal injuries.

**12:** ECGs will attack the team as it tries to take the argon canisters to location 14.

**13:** ECGs will attack the team here after it has attached the argon tanks to the life support system at location 14.

**14:** This is where the team attaches the argon canisters to the life support system. This will flood the ship with the gas to incapacitate the ECGs. However, the ECGs can block the flow, requiring the team to go to location 4 to override the block.

**15:** Ladder down to location 10.

Level 4 —  
Cargo

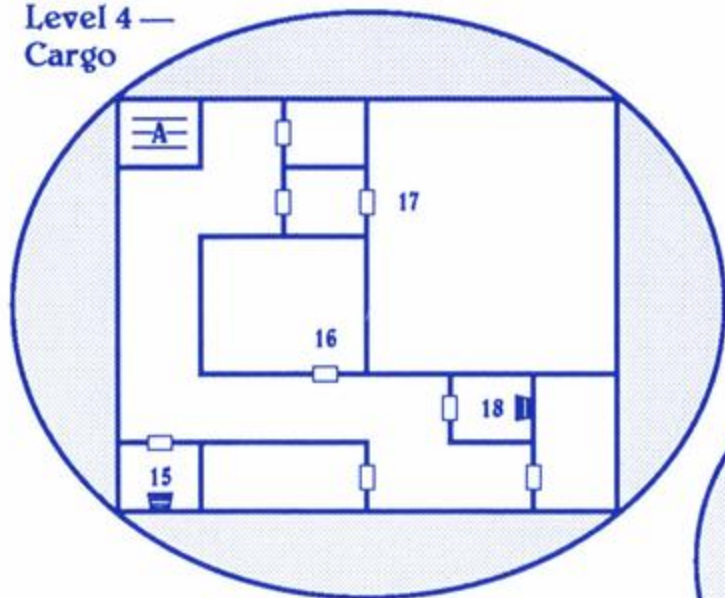

Level 7 —  
Crew

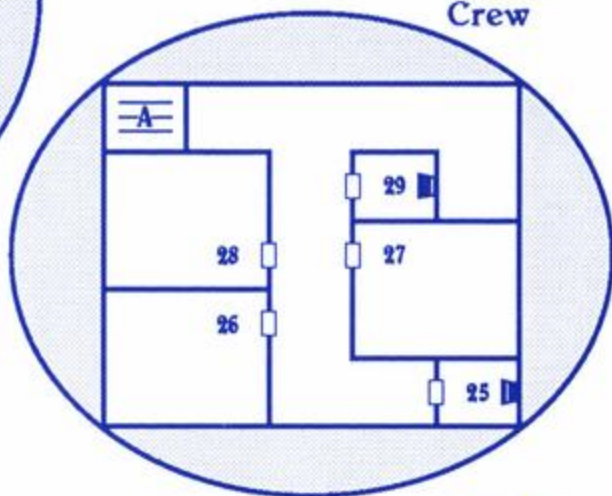

Level 5 —  
Galley

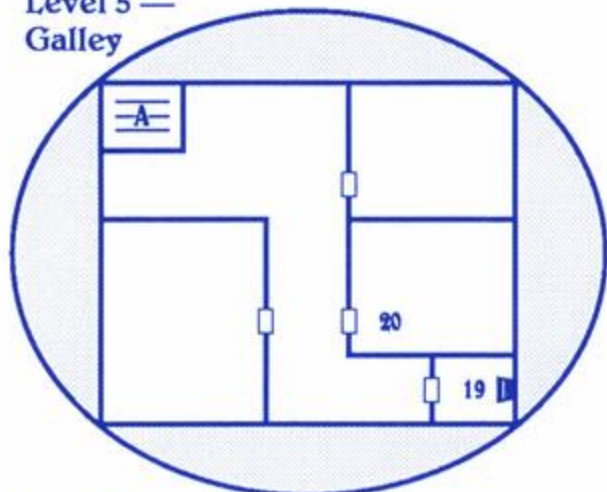

Level 8 —  
Security

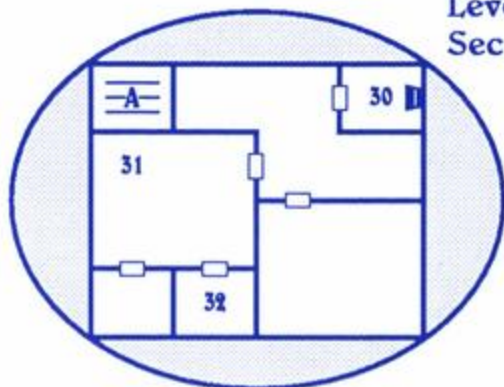

Level 6 —  
Sick  
Bay

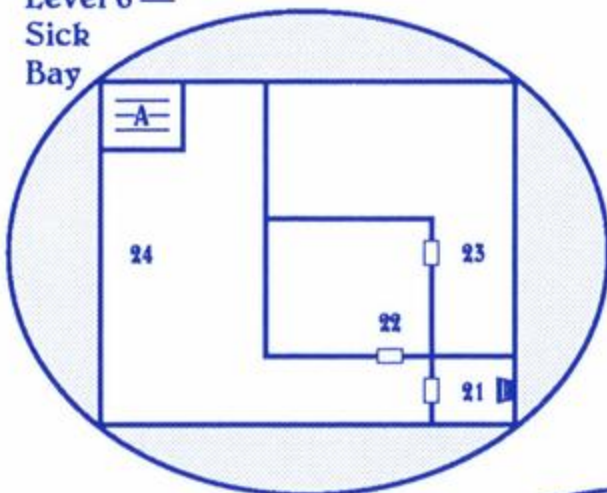

Level 9 —  
Computer

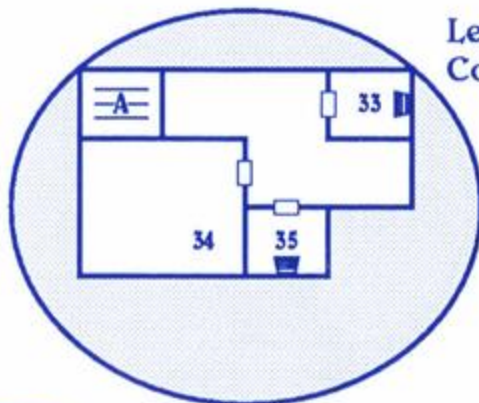

Level 10 —  
Control

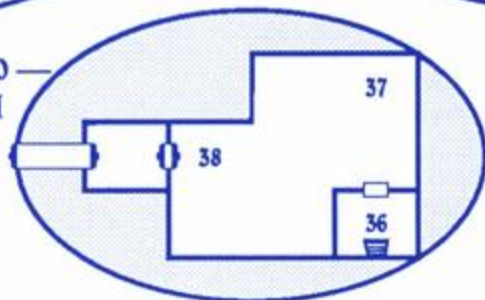



- 16:** This is where Dr. Donna Conchitez hid for several days after the ECGs took over the ship. Her diary contains useful information.
- 17:** This is the main cargo bay. It is filled with canisters which could be used to drop ECGs onto Earth.
- 18:** Ladder up to location 19.
- 19:** Ladder down to location 18 and up to location 21.
- 20:** RAM security troops were overwhelmed here.
- 21:** Ladder down to location 19 and up to location 25.
- 22:** This is the medical lab. A datacomp is here, but will only operate if it gets Scot.dos' voice print. It will reveal the ECG weakness to argon gas.
- 23:** This is the sick bay. The brain parasites can be removed by the auto-surgeons, if they use the sigma codes from either Commander Vilnikov (A22151) or Dr. Williams (A95151). A protective salve can be produced here which will prevent the parasites from infecting characters.
- Wounds can be healed and comatose characters revived here.
- 24:** This is a biomonitor station. From here the team can see the general distribution of life on the ship. The first time the station is used, an ECG will erupt from the nearby airshaft and attack.
- 25:** Ladder down to location 21.
- 26:** This is Dr. Williams' room, containing a folder on the ECGs.
- 27:** This is Dr. Donna Conchitez's room. Her diary contains useful background information.
- 28:** This is Commander Vilnikov's room. He died battling the ECGs, and his log can be found here.
- 29:** Ladder up to location 30.
- 30:** Ladder down to location 29 and up to location 33.
- 31:** These are the main security controls. If a programmer succeeds in disabling the console, no more robot encounters will occur. If the attempt fails, robots from location 32 will attack. Be sure to choose the character with the highest Programming Skill.
- 32:** Defense robots are stored here. Unless the security console has been deactivated, they will attack the team.
- 33:** Ladder down to 30.
- 34:** This is Scot.dos' main console. The security program isolated Scot here, after Scot's attempted takeover of the ship. The team can connect Scot to the adjacent console. Once this is done, Scot can inform them of events elsewhere in the ship and provide occasional advice.
- 35:** Ladder up to 36.
- 36:** Ladder down to 35. Until the argon is released through the ship, the team will be attacked on this landing every time they appear.
- The door to the control room is barricaded and it is suicide to enter until the argon is released.
- 37:** This is where the self-destruct mechanism can be deactivated. When the team deactivates the device, a stage three ECG will start firing on the team from location 38. The characters will have to charge and defeat the ECG.
- 38:** A stage three ECG attacks the team. Inside the airlock is a second ECG, readying a demo charge. If it is not shot, it will throw the demo charge and use the escape pod to flee the ship. If it is shot, it will fall back into the pod and explode with the other ECGs. This final victory will secure the ship.

## C. ASTEROID BASE LEVEL ONE

**Synopsis:** The characters' arrival on the base coincides with an accidental release of dangerous combat gennies. The team can take advantage of the confusion to explore and uncover clues. On the lower level, the team will locate a group of children trapped by the marauding gennies. The characters should bring them up to the escape ship at docking bay three.

**Random Encounters:** The release of the combat gennies has driven space rats into the upper level. These creatures normally confine themselves to devouring pests and trash. Being forced into the main living areas has made them hostile and dangerous.

## Locations

**E(1-4):** Elevators connecting to the lower level. After the team descends, the elevator shafts are destroyed to prevent the gennies from invading the upper level. Only the shaft at E3 remains passable, and it requires a rope to get up and down.

**D(1-4):** Docking bays. The team's ship is in bay two, while RAM is evacuating to a ship in bay three. If the team attacks the RAM forces or descends to the lower level, the ship will launch. RAM will leave behind a small escape ship for the trapped children.

**I:** Milo Phillips, the base administrator, is expecting the original RAM crew to be aboard the team's ship. He will be surprised when the team debarks instead. Because of the evacuation, Milo is dis-

## C. ASTEROID BASE

### Level One

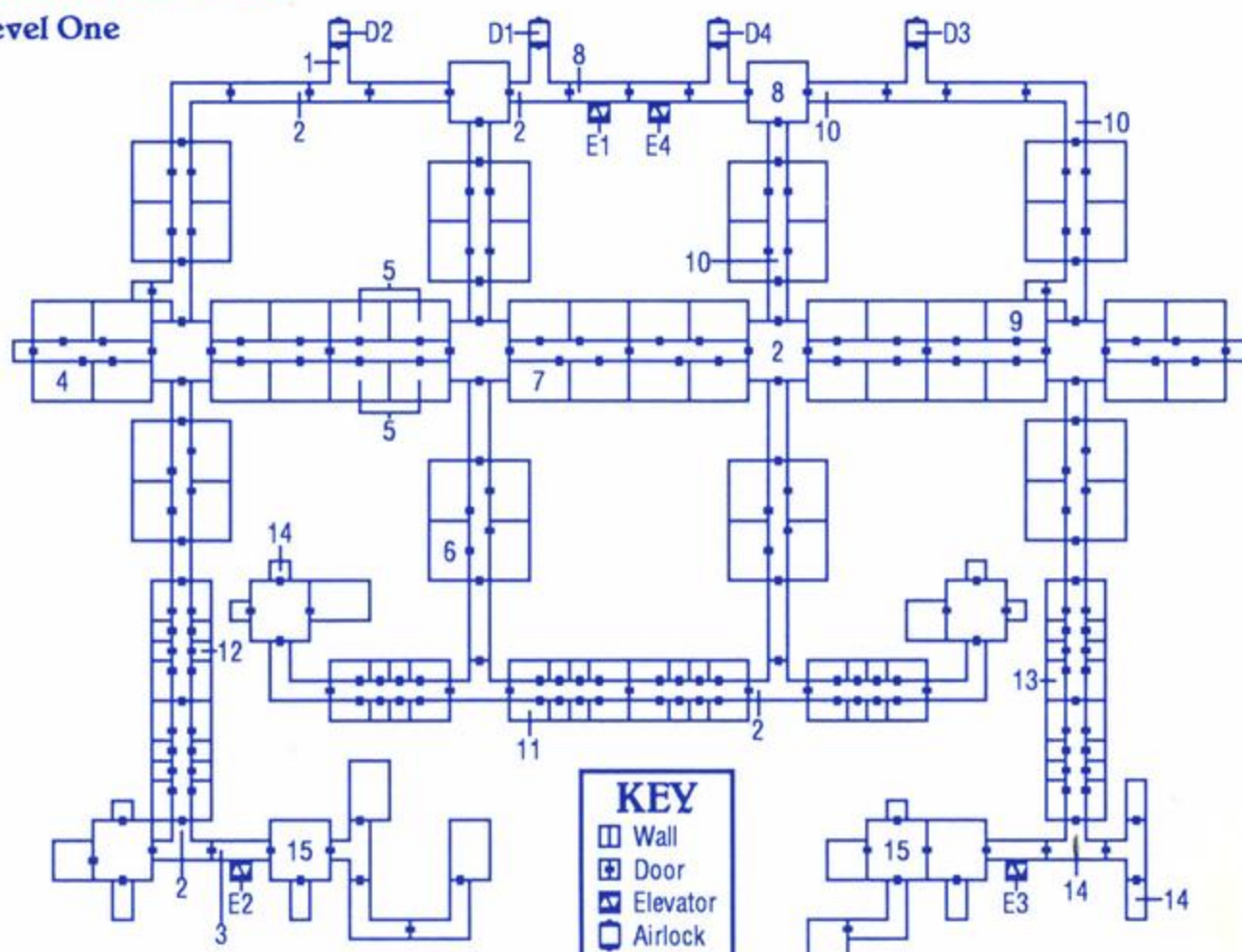

tracted and can be fooled into believing the team is here to help. He will direct them to the lower level where the gennies are running rampant.

If attacked, he directs his escort to battle the team.

- 2: If the team fooled Milo, the guard posts here will helpfully direct it to elevator two. Otherwise, these stations will be identical to location 8.
- 3: If the team has not begun fighting the RAM forces, it will receive useful equipment from this guard station.
- 4: The main communications room is sending an automated message, warning ships away from the base.
- 5: These are working medical labs. The team can be healed here.
- 6: The personnel office, where the team can gain information about Mars.
- 7: An office with information about Mars.
- 8: These guard stations protect the evacuation ship from hostile gennies and people. The team can withdraw from the post without fighting.
- 9: All of the base's robots can be deactivated from this room.
- 10: If the team has the children with them, the kids will direct it towards docking bay three.
- 11: Before the evacuation ship leaves, a mother is waiting for some of the trapped children. She mistakes the team for friendly forces and ask about the kids. She races off no matter what answer the team gives.
- 12: A child left a note for his evacuated family here.
- 13: If the team enters this room with the children, it finds the grandfather of one of the kids. He accompanies the team to the evacuation ship.
- 14: Valuable items were left behind here.
- 15: RAM poisoned its worker gennies, rather than leave them behind. Some still survive and can be saved with a Treat Poison skill roll. If the children are with the team, they will take the gennies with them to the evacuation ship.

## D. ASTEROID BASE LEVEL TWO

**Synopsis:** The goals here are to get the password for approaching Mariposa Three and to rescue the children at location 3. The password is inside the computers at location 1. The team has a small chance of succeeding with a Programming Skill check. If this fails, the team needs to get the week's password (written on a pad of paper at location 5) and a passcard from location 6.

**Random Encounters:** Three types of manufactured gennies are running rampant on this level.

## Locations

**E(1-4):** These are the elevators. They will be destroyed just after the team reaches this level. If the team has rope it can climb elevator shaft two.

**1:** These computers contain the password needed to slip past the RAM ships patrolling Mariposa Three. The team may succeed with a Programming Skill check, but this is unlikely. The team needs to get the week's password (DNA) from location 5 and the passcard from location 6.

## D. ASTEROID BASE

### Level Two

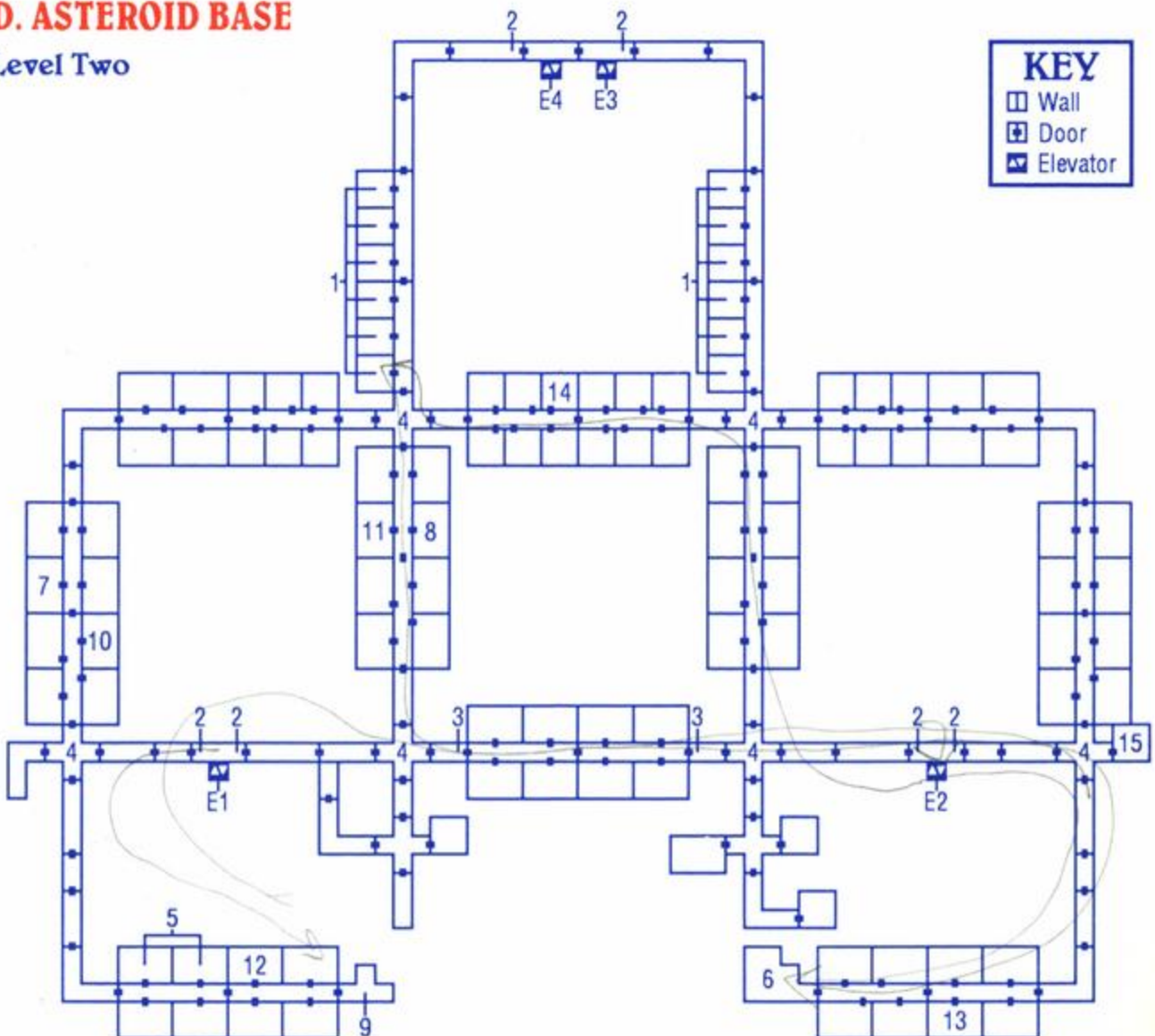

- 2: Gennies overwhelmed RAM sapper teams here. Some still have useful equipment.
- 3: These doors must be blasted open. The trapped children are on the other side. Most of the kids assume that the team was sent by RAM; one believes that the team is from NEO, but sees that as an adventure.
- 4: If the team has the children along, they will give information about the base.
- 5: The team can find the password (DNA) written on a pad here.
- 6: The room is full of reflectors for the satellites. Milo Phillips' keycard can be found here, if the team did not find it at location 7.
- 7: One of the kids spots a keycard in this room and attempts to retrieve it. The team must protect the children from a group of gennies. This will not occur if the card was already found at location 6.
- 8: One of the children attempts to free some caged rabbits here. The team will have to protect him from combat gennies which crawl from behind the cages.
- 9: A tiny prototype of the Doomsday Laser is in this test room. Its power is phenomenal for its size.
- 10: This gennie development lab contains information on the various rejected gennies.
- 11: This lab contains information on the gennie containment canisters. It indicates that the canisters can be opened by a radio signal. If the kids are with the team, one will sheepishly point out a radio she constructed that accidentally opened the canisters.
- 12: This lab contains plans for a laser thousands of times more powerful than the prototype the team finds on this base.
- 13: If the kids are with the team, one of them gives a speech here.
- 14: The room is full of boxes destined for Gradivus Mons. One of the kids will mention that the base is located on Mars.
- 15: The remains of the reflector satellites are scattered around this room. The satellites were to be put into Earth orbit, to aim the Doomsday Laser at specific targets. Since they could not be moved in the evacuation, they were destroyed.

## E. PIRATE SHIP

Level 1 — Engineering

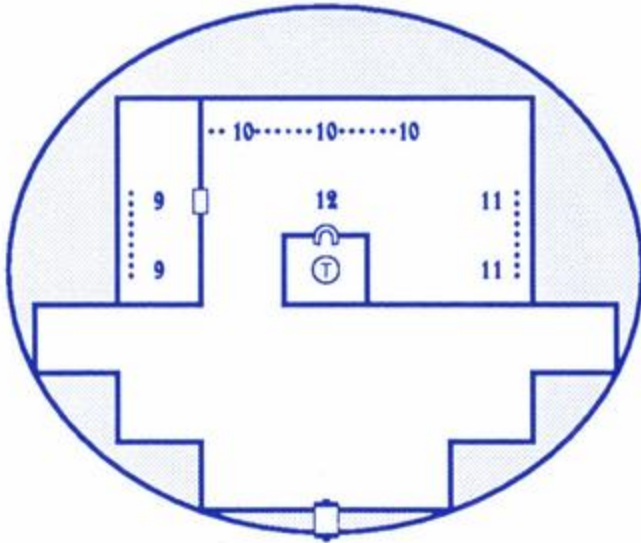

Level 2 — Storage, Cabins

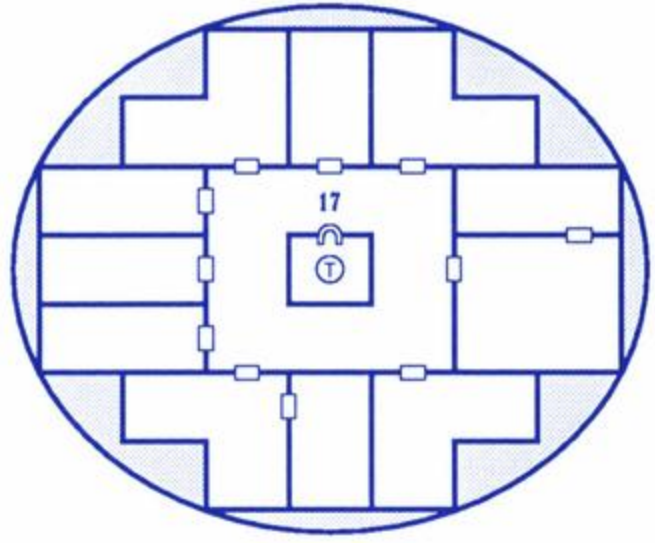

Level 3 — Storage

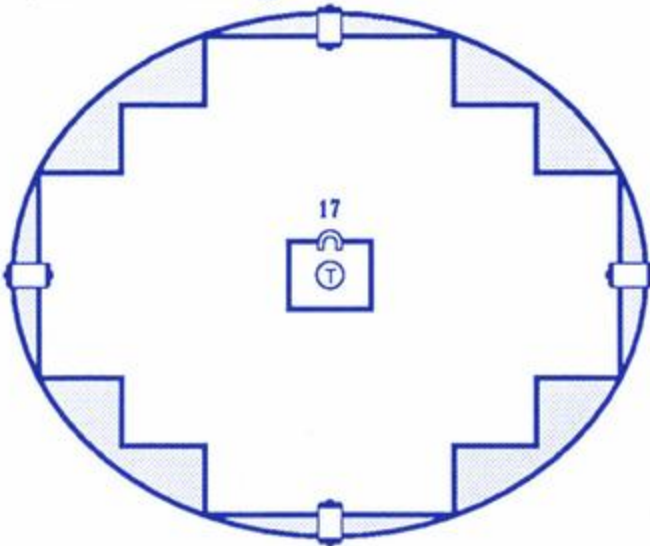

Level 4 — Storage

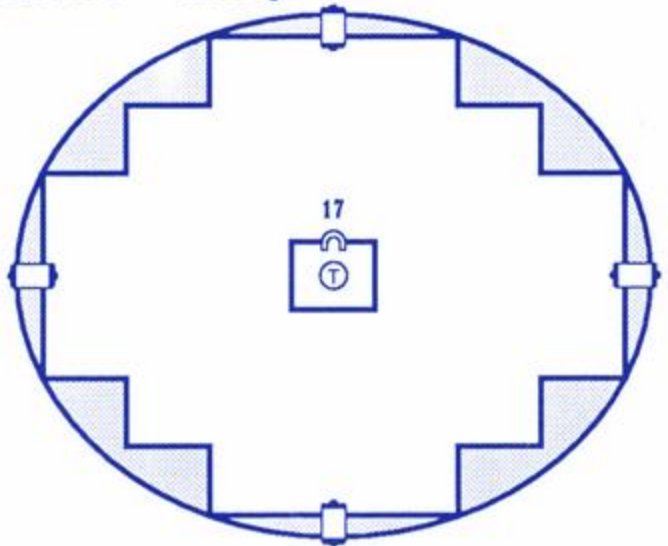

## E. PIRATE SHIP

**Synopsis:** RAM has hired Talon, a rogue pirate, to place a series of reflector satellites around Earth. Talon is en route to collect the satellites when the team leaves the asteroid base. He will disable the team's ship and order their surrender. The team can refuse and board the pirate's ship, but the characters will eventually be overcome.

The characters will be taken to the brig and stripped of equipment. There they will meet Buck Rogers, who is disguised and allowed himself to be captured. He was hoping to discover what Talon was up to. When the characters inform him of what happened

on the asteroid base, he will suggest an immediate escape.

Before the escape can take place, Talon challenges any one character to single combat. Talon is a high level Barney (a cyborg gennie) and very tough. No character is likely to defeat him. If Talon is defeated he will reward the team and release everyone.

After Talon's challenge, Buck will join forces with the characters and help them locate their equipment and disable the pirate ship. Buck and the team then return to Salvation.

## Level 5 — Holding Cell, Cabins

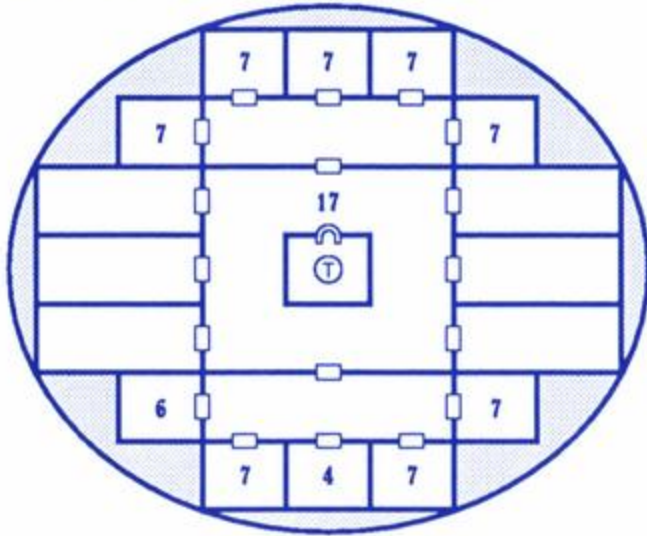

## Level 6 — Cabins

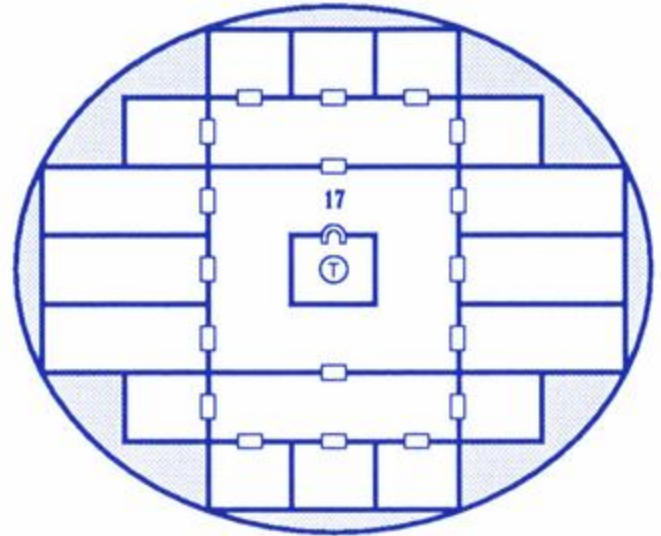

## Level 7 — Cabins, Medical Center, Storage

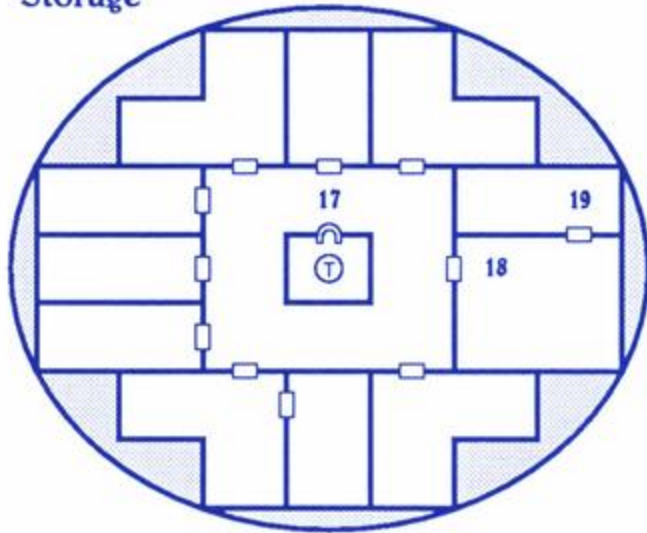

## Level 8 — Cabins

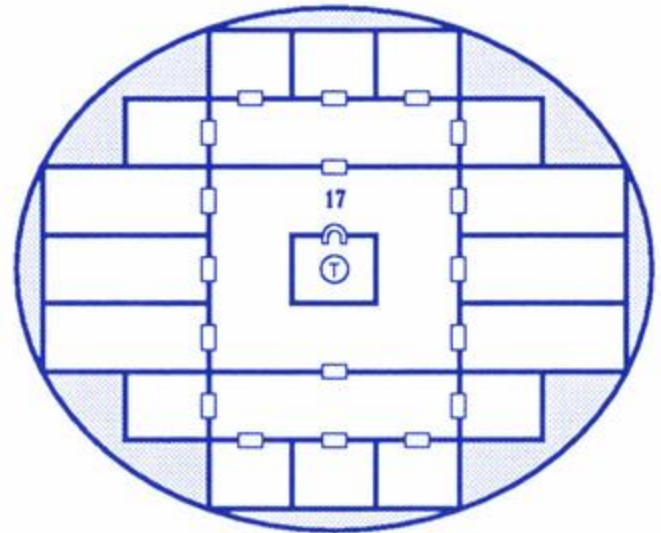

## KEY

	Wall		Door		Archway		Connecting Tunnel
	Airlock		Controls		Impassable/Hull		

**Random Encounters:** The ship is full of pirate patrols. There is a chance, based on play level, that the team can hide from them.

### Locations

**T:** This tube contains the ladder connecting all levels of the ship.

**1:** This is the boarding tube connecting the two ships. If the team retreats through here before the pirate's engi-

neering section is damaged, the team's ship will be destroyed.

**2:** Guards are posted here to prevent entry into the weapons section.

**3:** The bridge is the most heavily guarded section of the ship. The battle for the bridge is almost impossible to win. Buck will refuse to aid the team if it tries such a suicidal attack. However, if the team gains control of the bridge, the pirate ship is captured, and the team returns to Salvation.

Level 9 — Cabins

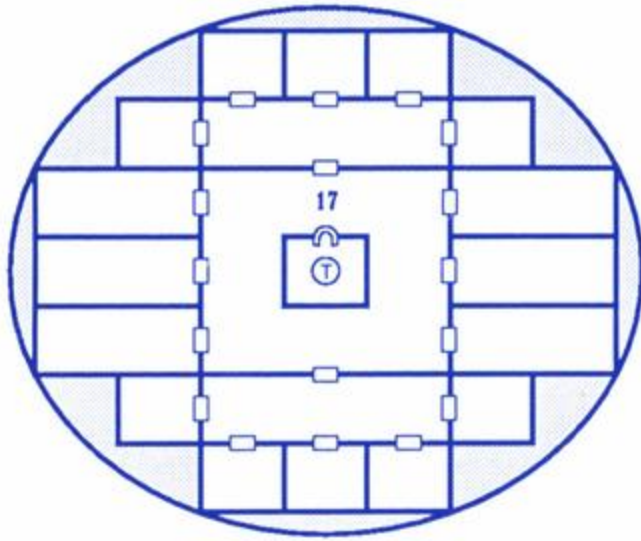

Level 11 — Boarding Tube, Cabins

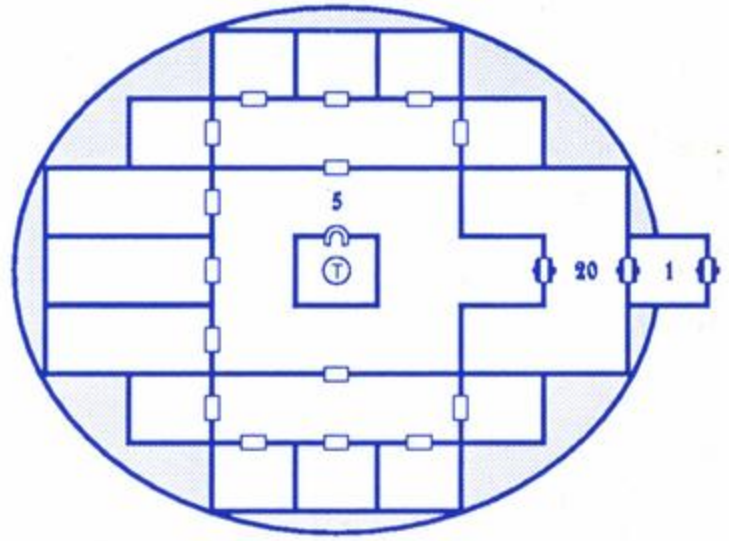

Level 10 — Galley, Cabins

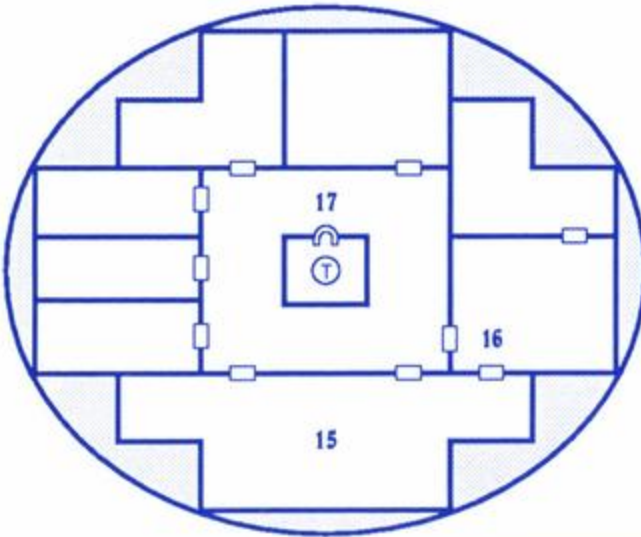

Level 12 — Captain's Quarters, Armory

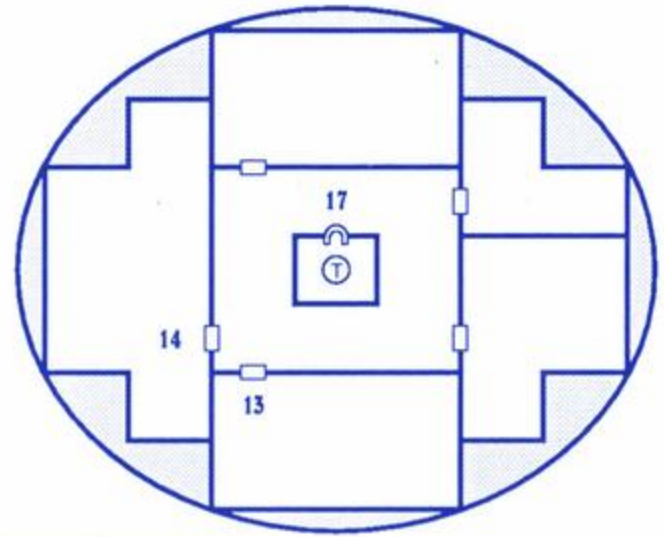

## KEY



Wall



Door



Archway



Airlock



Connecting Tunnel



Impassable/Hull

- 4:** This is the holding cell that the team will occupy. To escape, the team must succeed at an Open Locks or Bypass Security check. If the team fails repeatedly, Buck will open the door. Buck is very useful to have in the team, so he should be allowed to join.
- 5:** The entrance to the boarding tube level is always guarded.
- 6:** Buck has some hidden equipment here. It is useful for defeating the pirates.
- 7:** Empty holding cells.
- 8:** These are the bridge controls. The team will secure them when it wins the battle at location 3.
- 9-11:** All three of these engineering panels must be destroyed in order for the team to be able to escape the ship.



## Level 13 — Weapons

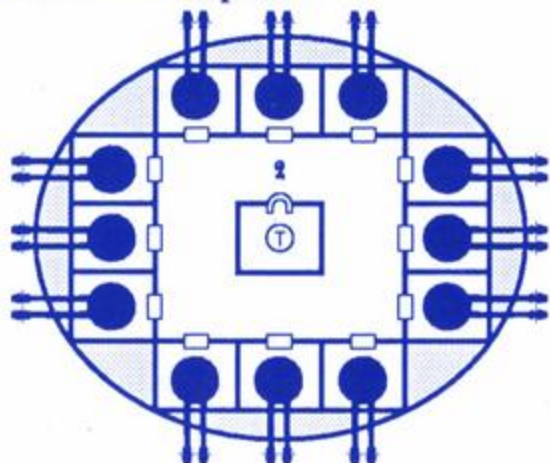

## Level 14 — Weapons

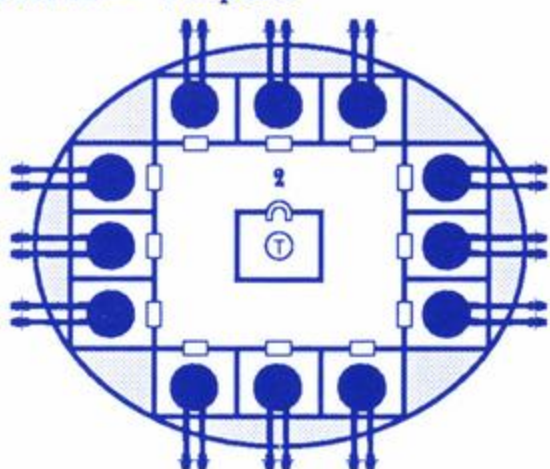

## Level 15 — Bridge



## KEY

**12:** The entrance to engineering is heavily guarded until the team sets off a demo charge at location 16. After that the force splits up, leaving a much weaker guard here.

**13:** The armory contains a large supply of weapons. It is best to enter by using Bypass Security or Open Door skills. If these fail, the team can use Demolition Skill, but this will trigger an alarm.

**14:** Talon's quarters are trapped to trigger an alarm. Buck is familiar with this system and will disarm it if he is with the team. If the alarm goes off, pirates will respond.

A terminal in the room gives deck plans for the entire ship and will indicate that location 16 is an ideal place to set an explosion.

**15:** The dining room contains hostile pirates.

**16:** Security and communication systems wiring goes through the wall of the galley. Setting off an explosion here will distract the pirate forces and allow easier access to the engineering section.

**17:** Pirates will guard these areas whenever an alarm goes off.

**18:** A medic can heal the entire team at this clinic.

**19:** A medical storage area with useful supplies.

**20:** The airlock into the pirate ship.

## F. MARS WILDERNESS

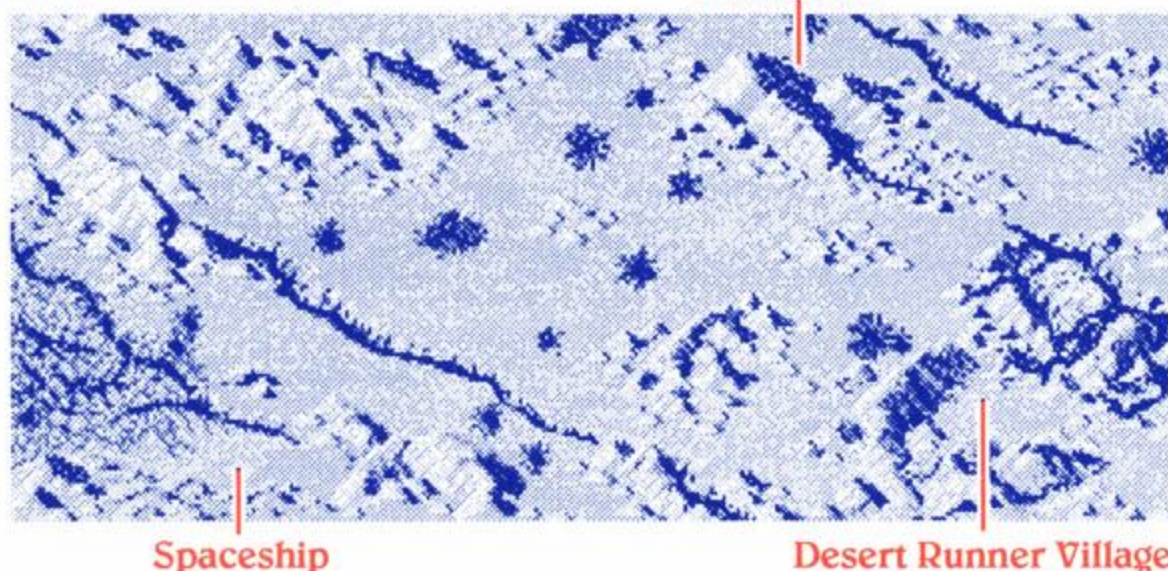

## F. MARS WILDERNESS

**Synopsis:** The team lands the ship at a remote site on the surface of Mars. The ship is then cloaked by a ground field, which causes the ship's skin to match the surrounding terrain. The characters will explore the region searching for evidence of the Doomsday Laser. Along the way they will discover blasted areas, including the melted ruins of a Desert Runner village. The village appears to have been blasted by some sort of high energy beam.

Scot.dos will intercept a message from RAM ordering a genocidal attack on the last village. The characters should rush to the village and aid the Desert Runners. Once the villagers are safe, the team should go with Tuskon — the village leader — to the RAM Base Gradivus Mons. When the base is destroyed, the team should retreat to its ship and leave the planet.

Mars Base

Spaceship

Desert Runner Village

**Random Encounters:** The Martian desert has four dominant life forms: the Sand Squid, Desert Ape, Hexadillo and Desert Runner. These gennies, along with RAM forces, can be met anywhere in the area.

### Locations

**The Ship:** This is where the team lands the ship. It must return here to leave Mars.

**The Village:** This is the only surviving Desert Runner village in the area. The team should head here immediately to protect it from RAM's forces.

**The Base:** This is where the Doomsday prototype is being tested. The team must go here to collect a Blue Passcard, which is needed to enter the Mercury Mariposa.

## G. DESERT RUNNER VILLAGE

KEY  Wall  Door  Impassable

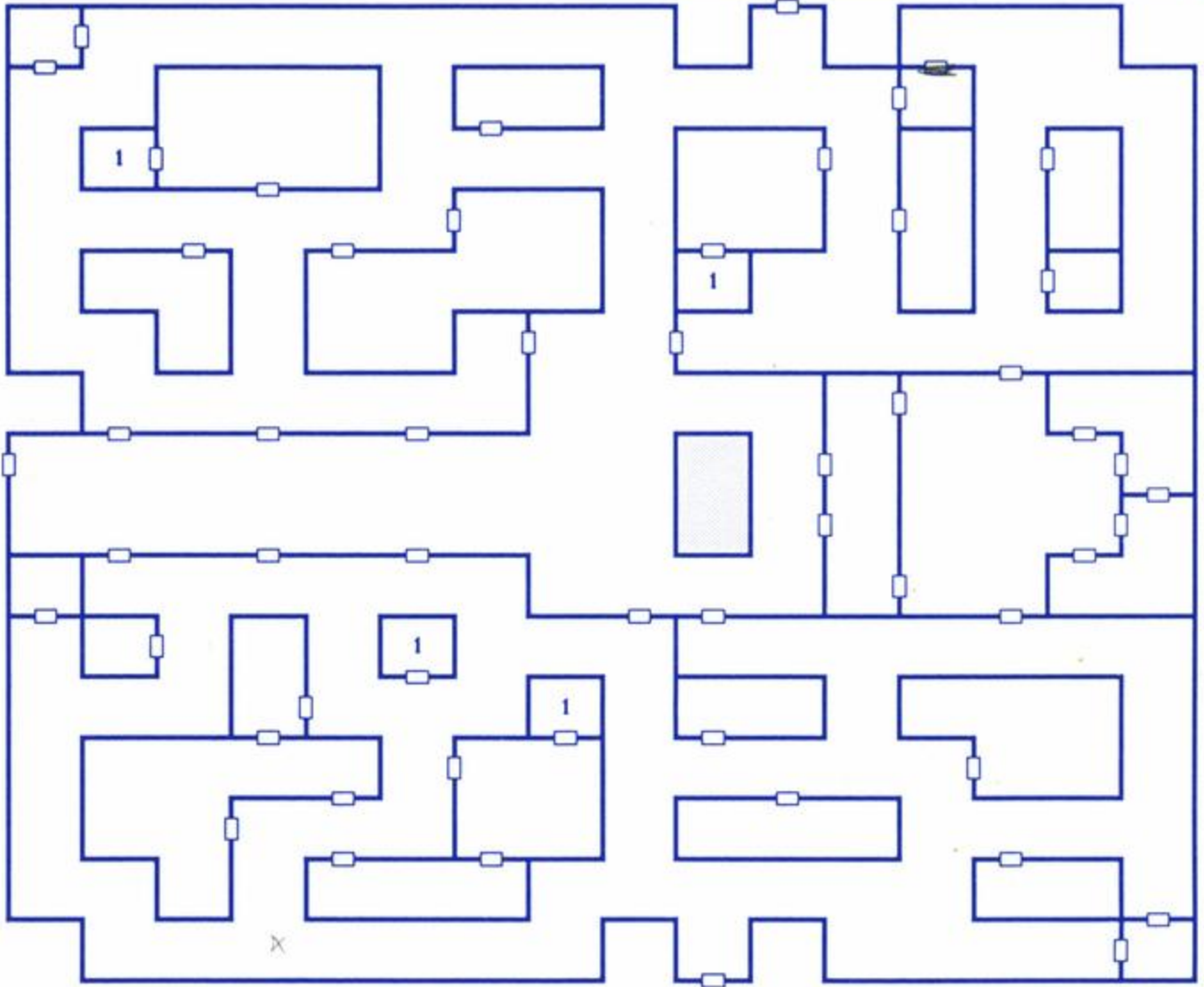

## G. DESERT RUNNER VILLAGE

**Synopsis:** The team can arrive in the village at several different times. If the characters arrive promptly after hearing of RAM's intention to attack, they can meet with Tuskon and forge an alliance with the Desert Runners. The later the team arrives, the less likely it will be able to make the alliance.

As the team wanders around the village, it has the option of joining bands of warriors. The team should do this so that it will have allies when the initial RAM attack takes place. The characters' goal is to hold off the RAM forces until the females and cubs can escape through underground tunnels. The Runners will howl when this occurs. The

team must then make its own way out of town and to the Runner's rendezvous.

### Locations

**1:** This is where the tunnels start. Early on, females and cubs are exiting through here. The characters will be considered cowards if they leave before the signal is given.

**Other Buildings:** During the early stages of the evacuations, people are busy gathering up items, preparing food and so on. After RAM begins its attack, more and more of the town catches fire. Many Desert Runners are trapped by the fire and the characters can impress the townsmen by rescuing them.

## H. MARS BASE GRADIVUS MONS

Level 0

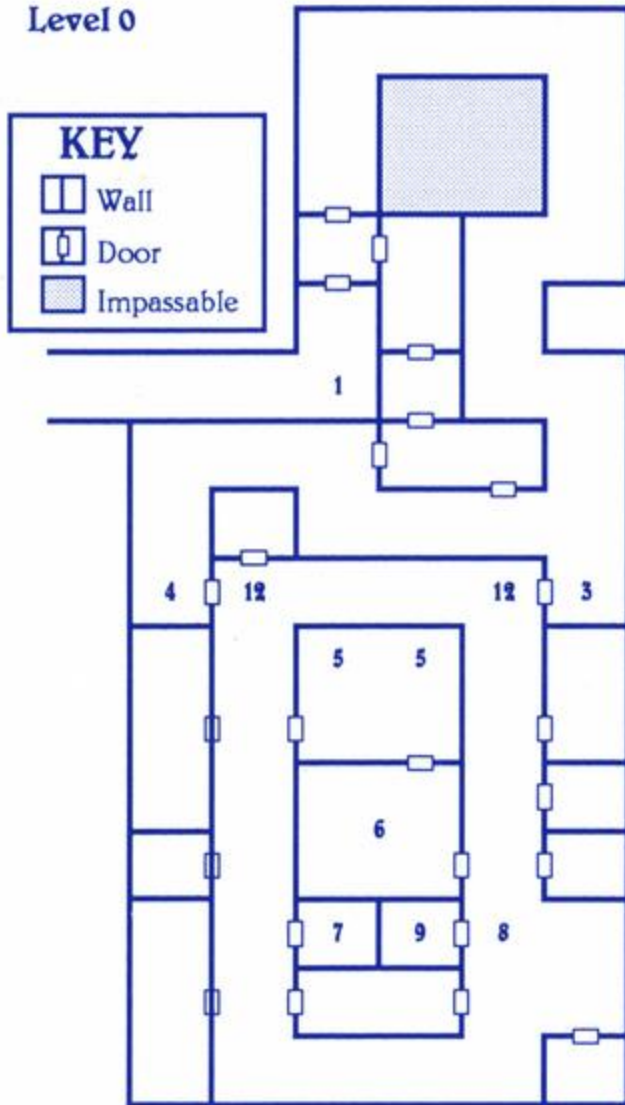

## H. MARS BASE GRADIVUS MONS

**Synopsis:** The goal here is to destroy the scale model Doomsday Laser on Level Four. The easiest way to enter the base is to befriend the Desert Runners from the village. They can disguise the characters and lead them to the back entrance. Otherwise, the team can locate the base after visiting the Desert Runner village, but the base will be alerted. The team must find the Blue Passcard to gain access to the fourth level. Once on the level, the characters must seize the device and overload it. Finally, the team must retreat before it is caught in the explosion of the base.

**Random Encounters:** Troops and dog gennies patrol the base. The team will run into larger numbers of patrols after the alarm has sounded.

### Locations

- 1: This is where the team begins if it has allied with the Desert Runners.
- 2: This is where the team arrives if it is alone.
- 3: These doors require a Red Passcard. Demo charges can be used, but will trigger an alarm. The team also might succeed with Bypass Security Skill. All red units are six member squads.
- 4: These doors require a Green Passcard. Demo charges can be used, but will trigger an alarm. The team also might succeed with Bypass Security. All green units are eight member squads.
- 5: Computer consoles. The team should check them frequently, since the information available to them will change. The team may turn off the alarm by filing false security reports. Also, different consoles may have different information available.
- 6: This is the power generator.
- 7: The elevator travels between the lower four levels. During alarms, the elevator may be guarded by a patrol.
- 8: This door leads to the hoist shaft.
- 9: The hoist shaft was designed to raise and lower the Doomsday Laser between levels. When the team arrives, it can climb the shaft to any level but four. The laser is blocking the shaft above level three. The shaft is never guarded.

After the team gains the Blue Passcard, it should climb up the shaft from Level 2. This avoids a large patrol at the elevator.

Level 1

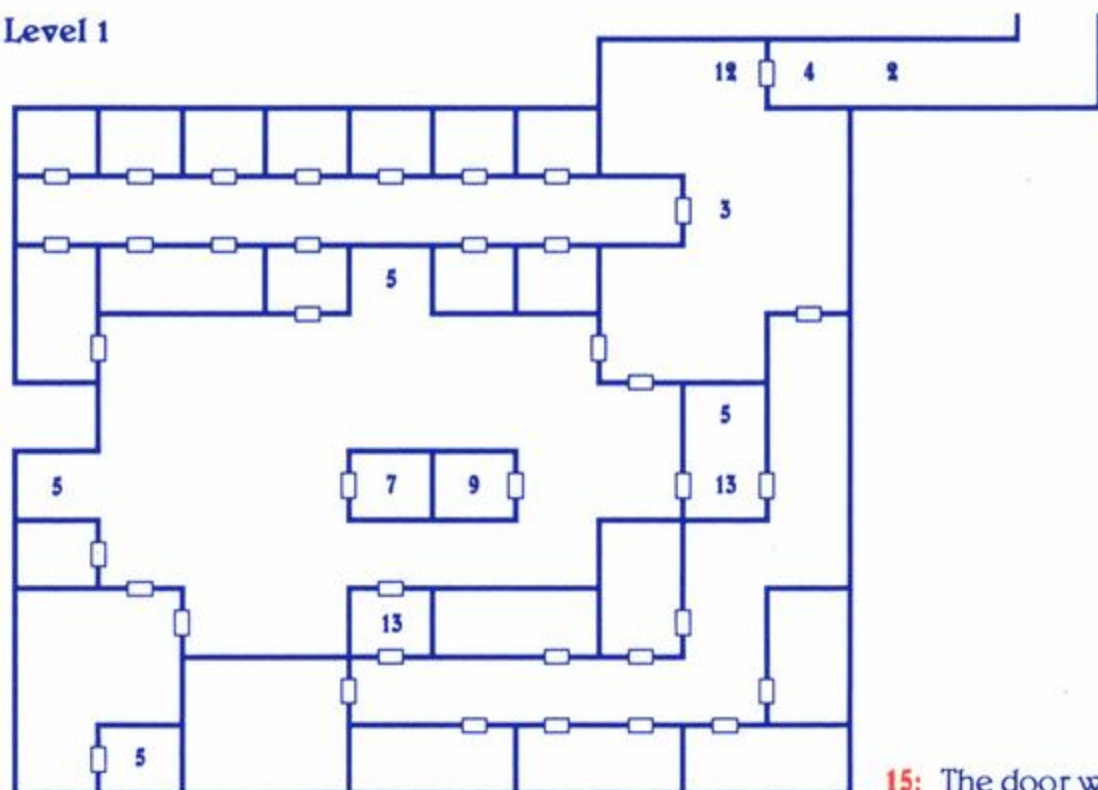

**15:** The door will only allow the team to pass if it relinquishes its equipment. When the team leaves it can recover its valuables.

**10:** The characters locate a White Passcard which will open the vault at location 11.

**11:** This vault can be opened by the White Passcard from location 10. It contains a Blue Passcard which will allow the team to reach level four.

**12:** These gates require the Blue Passcard.

**13:** These security stations are not fooled by any disguises the characters may use.

**14:** The technicians on level four will try to move the laser out of the team's reach. Others will shoot at the team from cover. A small magnetic platform lies here which must be operated by one of the characters.

One warrior should operate the platform and raise the rest of the team after the laser. The team will then fight for control of the weapon. The combat will cause the laser to begin to overload. The weapon will then sink back down the hoist shaft. The team should ride along so that it can quickly reach the exits on level zero before the weapon explodes.

Level 2

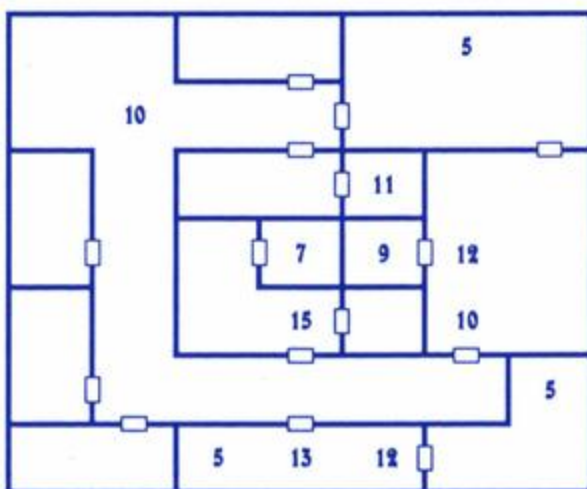

Level 3

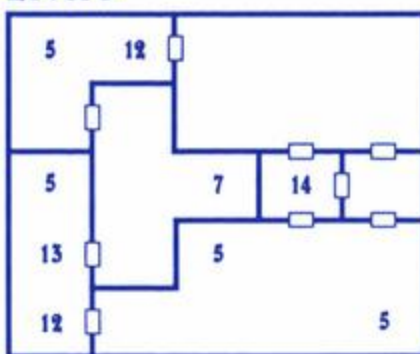

Level 4



## I. VENUS WILDERNESS

Lowlander Village

Acid Lake

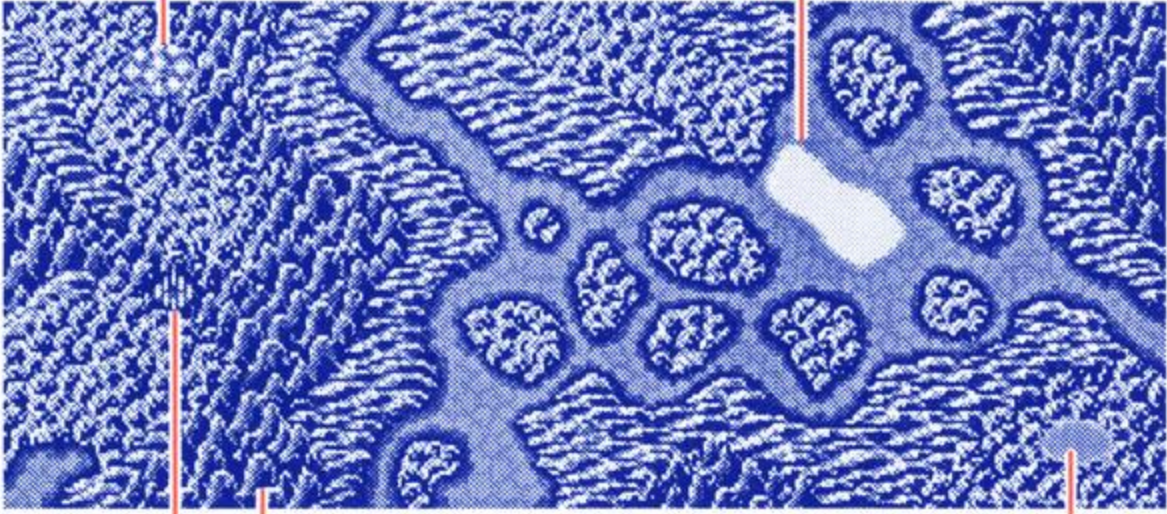

Ruins Base

Spaceship

## I. VENUS WILDERNESS

**Synopsis:** This is an acid jungle in the Lowlands of Venus. Within it are the Lowlander village, the ruins of a space elevator, and a subterranean RAM base. There is also an acid lake in the northeast area of the wilderness map.

**Random Encounters:** Soon after entering the wilderness the team will encounter a group of hostile Lowlanders. No matter what the team does, the encounter will eventually be interrupted by a RAM attack. After the attack, the leader of the Lowlanders will offer to join the team. There will also be random attacks of Swamp Hornets and RAM warriors as long as the team is in the wilderness.

### Locations

**The Town:** Very few Lowlanders have survived a recent RAM raid on this town. The survivors will gladly help the team work towards RAM's defeat.

**The Ruins:** After leaving the town, the team hears marching in the distance. If they follow the sound it will lead to the ruins.

**The Base:** If the team approaches the base directly, it will be attacked by security robots. If it attempts a sneak approach, each member of the team will be checked for the Hide in Shadows skill. If any character passes the skill roll the team may enter unmolested.

**The Ship:** This is where the team lands its ship. It must return here to leave Venus.

**The Acid Lake:** When the team first arrives here it will encounter a group of acid frog gennies. If it befriends them (with a successful Befriend Animal skill check) the frogs assist in all later wilderness battles. Otherwise, the frogs attack. After encountering the frogs, walking in the lake for too long damages all characters.

## J. LOWLANDER VILLAGE

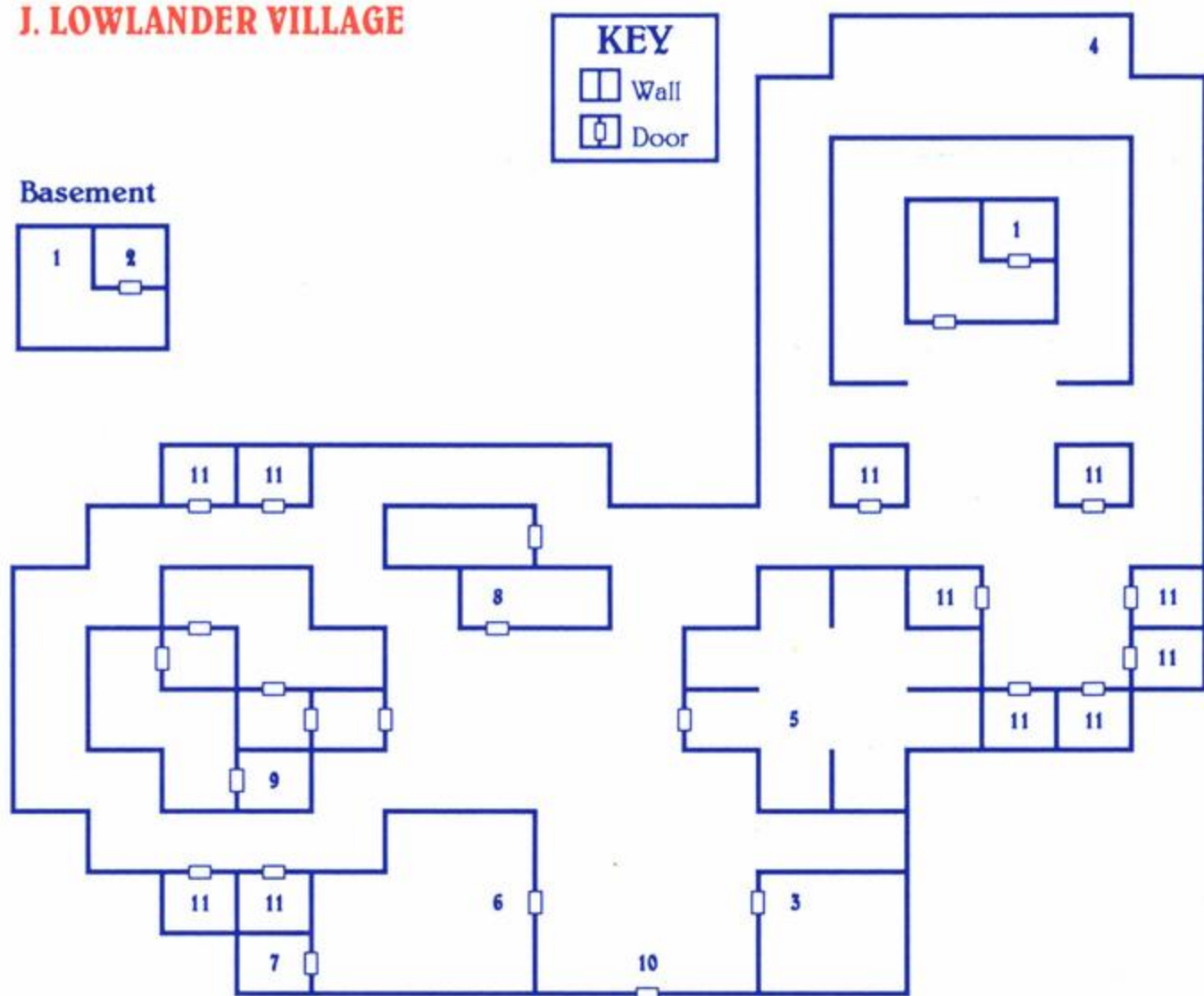

## J. LOWLANDER VILLAGE

**Synopsis:** Most of the Lowlanders in this town were killed by RAM warriors before the team arrives. Now there are only a handful of survivors and some RAM troops. The team will find one group of survivors that it will be able to help before it leaves the village. A young Lowlander joins the team, looking for his father.

**Random Encounters:** There are RAM assassination teams lurking around the village, searching for the survivors. If they find the team, they'll gladly kill the characters instead.

## Locations:

- 1: This secret ladder leads to a basement under one large hut.
- 2: A Lowlander child is hiding here. He will join the team once it meets him. Without him, the team will not be able to complete the Venusian RAM base.
- 3: A RAM guard sleeps here with a huge keyring attached to his belt. One character may steal the keys, and if he has enough Pickpocketing Skill the guard won't wake up. If a character accidentally wakes him or tries to kill him, the team must fight the guard and some robots before getting the keys. The team needs the keyring to get into a closet in town, and also to enter the Venusian RAM base.

- 4:** The team finds a group of Lowlander refugees preparing to climb over the wall. One of them is severely injured and requires medical attention. The team must bring them a Lowlander medical supply kit found in location 9. A refugee gives the team a security code for location 9, but the team also needs the keyring at location 3 to get into the closet.

Once the characters bring them the kit from location 9, they will be given a partial map of the Venus RAM base.

- 5:** The characters find a Lowlander hiding here. If they identify themselves to him, he will give them some useful information.
- 6:** This stockade is filled with domesticated acid frogs. They will stampede if the team opens the door. If the team befriended the frogs in the wilderness, the frogs will attack RAM forces and diminish the probability of running into RAM assassination teams.

If the characters fought with the acid frogs in the wilderness then these frogs will sense that they are enemies and attack.

If the characters never met the acid frogs in the wilderness then the frogs ignore them entirely and stampede directly through the team, causing damage.

- 7:** This is a shed with a canvas sack filled with acid frog food... bits of swamp hornets, giant worms, etc. If the characters taste the food they will take damage.

If the team takes the bag it will be able to use it later to befriend the acid frogs.

- 8:** This is a storeroom for the village. If the team comes here before releasing the acid frogs in location 6, the room will be infested with swamp hornets. If the team fights the hornets, it will find a tin with credits and equipment.

If the team arrives after releasing the acid frogs in location 6, the frogs will have eaten all the hornets. They won't attack. If the team gives them the bag of frog food from location 7, at least two acid frogs will assist in the rest of the team's battles.

- 9:** This is the medical supply closet. The team can't open the closet unless it was told the security code at location 4 and has the keyring from location 3. Once the door opens, the team can take the medical supply kit, which it can trade for a map by returning to location 4.

- 10:** This is the only way in or out of town. If the characters try to leave without the young Lowlander, they will hear him crying in the distance.

- 11:** The team can gain clues about where to go in town by entering these small huts. No combats or encounters occur here.



## K. VENUSIAN SPACE ELEVATOR RUINS

**Synopsis:** While exploring the ruins of the Venusian space elevator, the characters discover a secret RAM glider hangar. They have the chance to destroy the hangar before the gliders can be used to exterminate the Lowlander population on Venus.

**Random Encounters:** There are no random encounters in the ruins until the team blows up the gliders in the hangar. That alerts RAM and the team will be attacked intermittently by RAM warriors and Heavy Combat robots until it leaves the ruins. The characters may also be attacked by Swamp Homets and Ursadders that enter the ruins after the explosion.

### Locations:

- 1:** The team can climb out of the ruins here into the Venusian jungle.
- 2:** This is a dark tunnel dripping with acid. It leads to the Venusian RAM base, but if the team has blown up the gliders, a garrison of troops will be waiting at the RAM base on the other side.
- 3:** These stairs lead from the ruins above to the glider hanger hidden below.
- 4:** This is a small computer room with a lone RAM technician. The characters must interrogate him to get a key to a nearby security door. He triggers an alarm if the characters release him.
- 5:** This is a security door that the team can't get through unless it gets the key from the technician at location 4.
- 6:** This is the glider hangar full of deadly RAM gliders. After the team blows up the gliders, jungle animals enter the hangar through the broken dome above.

## K. VENUSIAN SPACE ELEVATOR RUINS

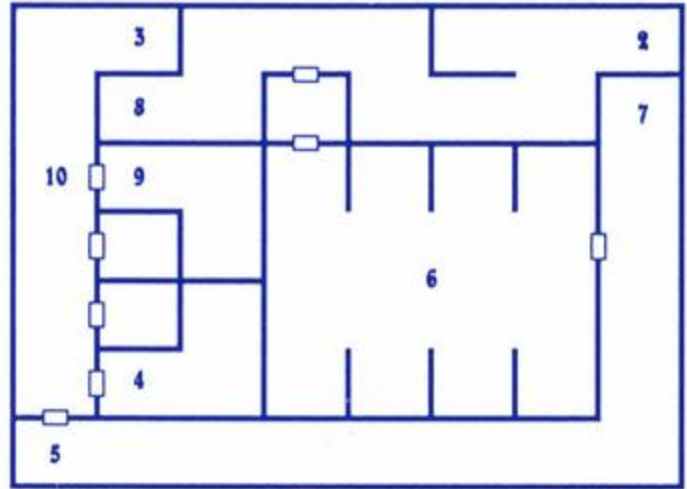

**KEY** □ Wall □ Door

- 7:** The team finds a detonator keycard. If it found the control box at location 8, it is given the option to blow up the gliders. Characters get experience points for destroying the gliders.
- 8:** The team finds a control box used for causing the gliders to self-destruct. If the team has the detonator keycard from location 7, it is given the option to destroy the gliders.
- 9:** This is a meeting room. It is empty before the explosion. After the explosion, a carnivorous Venusian plant is here. Approaching the plant causes it to shoot barbed spores at the team for damage, unless a character is acrobatic enough to avoid being hit.
- 10:** A bundle of cables hangs especially low. After the explosion it collapses, and if the team wants to pass, one character must climb over to clear a path. Whether he succeeds or fails, the team will be able to pass after the attempt.
- 11:** Some Ursadders have made a den in this dark, dank section of the ruins. The gennies will attack if the team approaches. After the battle, the team has the option to search the den, but will find nothing of use there.

## L. VENUS RAM BASE

Level 1

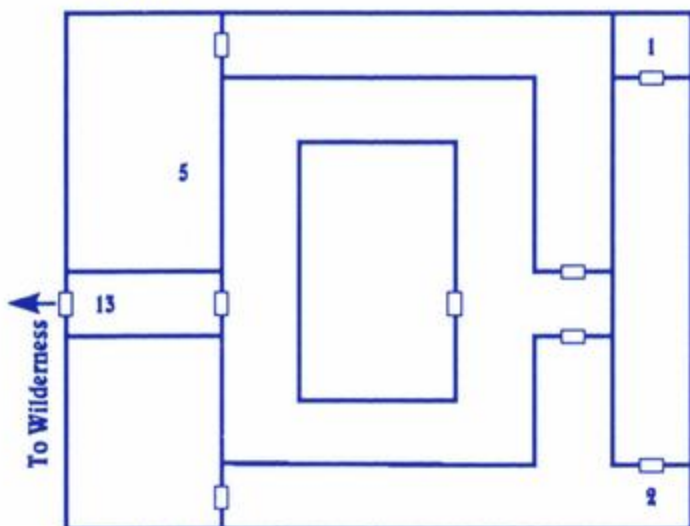

Level 2

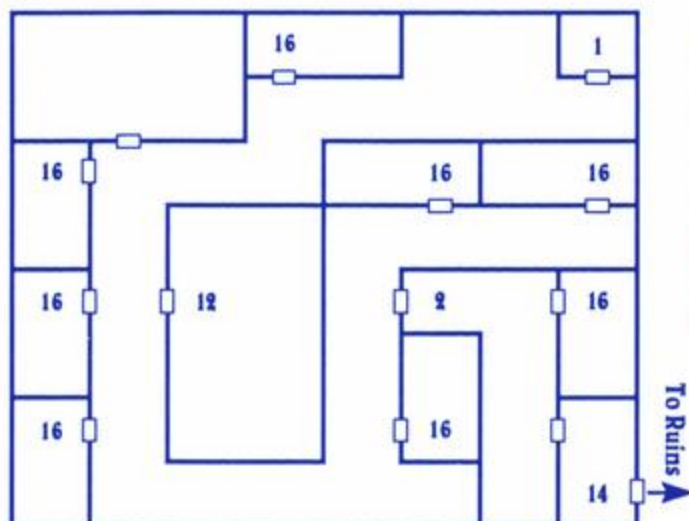

Level 3

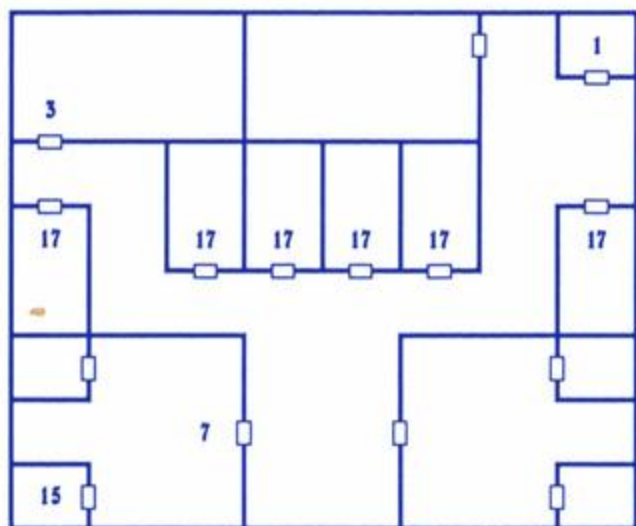

## L. VENUS RAM BASE

**Synopsis:** After having visited the Lowlander village, the team locates the Venusian RAM base. Several Lowlander scientists are prisoners here, and the father (Landon) of the Lowlander child is hiding on the fourth level. Landon helps the team find a Retinal Lockpick required to enter the Mercurian Mariposa.

**Random Encounters:** The team encounters different enemies depending on what level of the base it is on. The first level is populated by RAM warriors. They are searching the labs looking for the missing Retinal Lockpick. The second level is guarded/tended by acididium. The third level, with administrative offices, is heavily guarded by security robots. The fourth level is under construction and therefore not guarded at all.

It doesn't matter whether or not the team eats the junk food on level two.

### Locations:

- 1:** This elevator is the only transportation between the four levels.
- 2:** These locked doors can't be opened without the keyring from the village. The team must have the keyring.
- 3:** A group of Lowlander scientists are locked in this room. They explain that one of their group, Landon, is on the fourth level searching for a utility tunnel so the group can escape. Landon won't come out of hiding to talk to the team until it meets the prisoners. The prisoners stay in this room until Landon sends for them.
- 4:** Once the team talks to the scientists in location 3, Landon meets it here. If the Lowlander child never joined the team, Landon sends the characters back to the village to find him. If the young Lowlander is in the team, he rejoins Landon here.

## Level 4

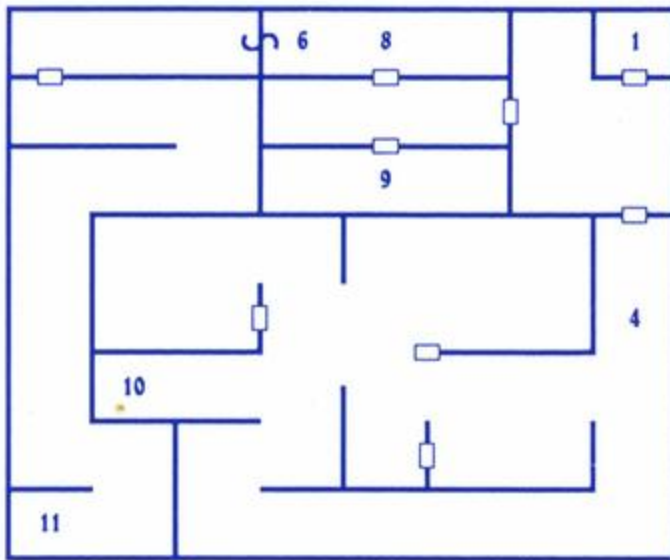

**KEY**  Wall  Door  Secret Door

If the child joined the team but was killed, Landon will still help the team.

Landon sends the team to the first level to recover a Retinal Lockpick he has hidden there. The lockpick cannot be found until Landon reveals its location.

When the team returns with the lockpick, Landon will ask it to help him find the secret door that leads to the escape tunnel. After the characters locate the tunnel, Landon sends the team to free the prisoners on level three.

Finally, if the characters return after telling the prisoners to meet Landon, they receive experience points. If Leander is with the team, he will leave now.

- 5:** The Retinal Lockpick is hidden under a floor panel here. The team must have the Retinal Lockpick to get to Mercury! It can't be found until Landon tells the team precisely where to look.
- 6:** In the western wall is the secret door Landon is searching for. It can only be found by stepping through it.
- 7:** Three RAM warriors are in this computer room. The characters may intimidate them, fight or leave. If they attack, the

warriors will be frightened and try to escape. If they leave, the warriors will be encouraged by their show of cowardice and attack.

If a character successfully intimidates them, the team has the option to lock them in the storage closet or attack.

No matter what, the team will receive the information that the Doomsday weapon is located on the Mercurian Mariposa III.

- 8:** Acidicium are kept here when they are not on patrol in the barracks. The team must fight them to get to the secret door.
- 9:** This room is full of activated combat robots. If the team enters, it will have to defeat them.
- 10:** This is RAM's first attempt at building a utility tunnel under the acid swamp. It is full of acid. It is also full of Ursadders, so if the team approaches it will have to fight them.
- 11:** This is the utility tunnel that Landon and the scientists escape through. It is full of acid, so the characters can't enter without losing their armor and probably their lives.
- 12:** This is a meeting room full of RAM officers. The characters may surrender, run or fight. If they run, the officers fire after them and they'll take damage. The officers also sound an alarm, making random encounters more likely thereafter.

If the team surrenders, the officers will keep shooting until the characters die or run away.

If the team fights, it fights RAM warriors.

- 13:** This is the main entrance to the RAM base. It leads to the wilderness.

If the team enters from here before blowing up the gliders in the ruins, it finds troops guarding the door. It will

have to fight RAM warriors, security robots and Venusian combat gennies before getting in. If it enters from here after blowing up the gliders, the troops are at the tunnel entrance and there won't be a battle.

- 14:** This tunnel leads to the RAM glider hangar under the ruins.
- 15:** If a character intimidated the technicians in location 7, then they are locked in here. The team may leave them alone or kill them.

**16:** These are the barracks for the RAM soldiers. There is a chance of a combat with RAM warriors and assassins upon entering.

**17:** These are the offices on the administrative level. There is a chance that RAM assassins will attack the team if it enters an office.

## M. MERCURY MERCHANT'S AREA

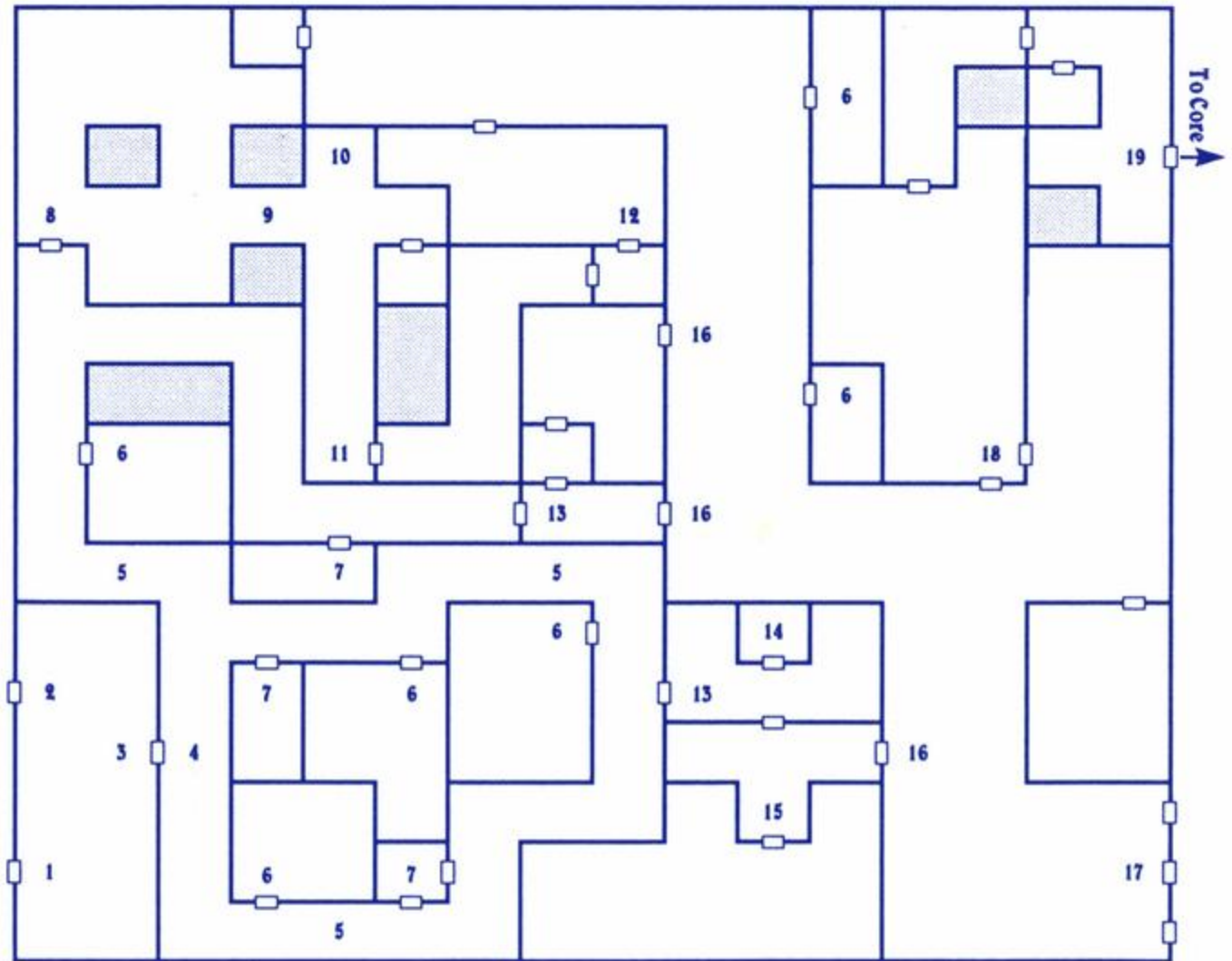

KEY					
	Wall		Door		Impassable

## M. MERCURY MERCHANT'S AREA

**Synopsis:** The team bypasses the blockade of ships around Mariposa III and slips inside the station. The characters' goal is to reach the core so that they can climb up and destroy the Doomsday Laser.

The characters need the password from the Asteroid Base, the Blue Passcard from Mars and the Retinal Lockpick from Venus to get into the Mariposa.

Within the Merchant's Area are Wilma Deering and a separate force of rebel Mercurians. Wilma will take the team's identity cards and arrange to distract the security forces. The Mercurians are expecting a band of Dancer commandos and can easily mistake the team for them. The Mercurians will direct the team to a safe path to the core.

The ideal path is through Marat's Bazaar (Location 8) to the parade (Location 12). The team should disguise itself and travel with the parade until it reaches Holst Plaza (Location 18). Then it should travel to the core entrance (Location 19).

**Random Encounters:** As the team travels with the parade, security teams may spot them. Due to the crowds, the team should avoid fighting if possible. If conflict is inevitable, the team should be certain not to use their weapons. The slaughter of innocent people would not be good press for NEO and it would attract undue attention.

## Locations

- 1: This is where the team arrives. The characters can reenter their ship at any time before they leave the embarkation area.
- 2: The door into the hangar is sealed due to a security alert. RAM is stopping all normal traffic to and from the Mariposa now that the Doomsday Laser is nearly operational.
- 3: The Mercurian security will pass the team through here, if it has the Blue Passcards from the Martian Base. Once through this door, the characters cannot return to their ship.
- 4: Wilma will meet the team here and take their passcards. She will warn it away from the security gates, then go to set up a diversion.
- 5: A man will step past and mumble 'one if by land'. If the team replies 'two if by sea', the man will assume that it is the Dancer commando team. He will then give them directions to the core.
- 6: These are closed stores. Everyone is off to the parade.
- 7: Maintenance robots are stored in these rooms.
- 8: This is Marat's Bazaar; an amazing array of gaudy and archaic merchandise. The team should go through here to reach the unused maintenance shaft.
- 9: A live Earth parrot perches here. If someone in the team has Befriend Animal skill, then the parrot should be fed to elicit information. The parrot will reveal the password 'Bastille' which will aid the team when it meets the renegade Sun King in the core.
- 10: An archaic computer monitor where the team can contact Scot.dos.
- 11: Some rope has been left next to this old maintenance door. It will be useful when climbing the core.
- 12: The team will encounter a crowd about to embark on a parade, and they will invite the team to join them. If one of the characters has Disguise Skill, the team will blend into the crowd. Security forces will then tend to overlook the characters.

- 13:** These are the two security gates into the Rue de Sol, the main avenue of the Mariposa. Security has been alerted that Blue Passcards have been used to gain entry to the Merchant's Area. The troops will attack the team on sight.
- 14:** A security office which contains information about a Dancer commando team that was arrested.
- 15:** This is the entrance to the Stock Exchange. Security has set up an ambush here. They believe that the renegade Dancer commandos have targeted this position, since the Doomsday Laser is a secret project.
- Scot.dos will warn the team, but if it proceeds it will find a very dangerous battle.
- 16:** If the team has fought through a security gate, it will meet the parade at one of these points. The team should go with the parade until it reaches Holst Plaza (Location 18).
- 17:** This is the gateway at Joplin Plaza. Security has heavy weapons and is checking everyone. The team should turn around before it reaches this point. If not, the characters should immediately surrender.
- If the team surrenders, it will be rescued by either Wilma or the rebel Mercurians, who will leave them in Holst Plaza (Location 18).
- 18:** This is Holst Plaza where the team ends up after the parade.
- 19:** This is the entrance to the core. Once the team enters, it cannot return.

## N. MARIPOSA CORE

**Summary:** The team must pass through this area on its way to the Doomsday Laser at the top of the core. Unless the team befriends the Sun King on these levels, it will take a great deal of damage traveling through the upper four levels of the core. To befriend the Sun King, the team needs to bring him three coins, one found on each of the three levels beneath his own.

**Random Encounters:** Security and assault robots will be met in various numbers until the team befriends the Sun King.

## Locations

- 1:** This is the zero-gravity core that extends through the Mariposa. On any of these levels the team can leave the core if it wishes, or move upwards or downwards within it.
- 2:** This section of the core is not attached to any rooms, so only upwards or downwards travel is possible. Weapons mounted on the sides of the core will fire on the team, doing considerable damage, if it has not yet befriended the Sun King.
- 3:** This is the Sun King's audience chamber. He will first ask the characters 'Parlez-vous Francais?' ('do you speak French?') If they say 'Non' (no) they are thrown out of the audience chamber. They have one chance to apologize for their breach of manners if they reenter the room. If they don't apologize, they will never be allowed back into the audience chamber and must take the damage in the upper portion of the core.

If the characters say 'Oui' (yes) the Sun King will then ask 'Êtes-vous le dansaurs?' ('Are you the dancers?') It doesn't matter what they answer to this, as he will recruit the team to his service anyway.

## N. MARIPOSA CORE

### Level 1

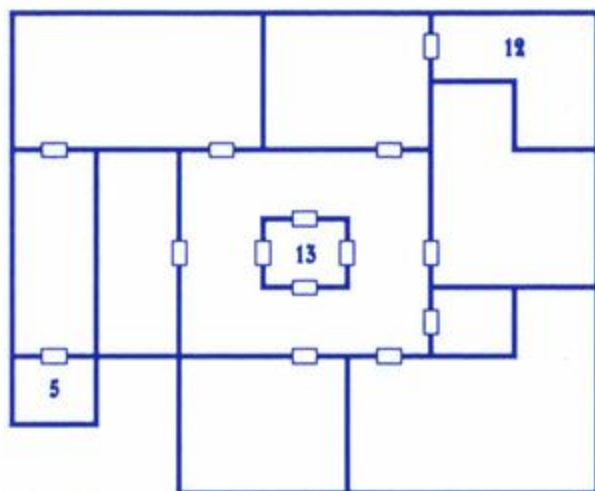

### Level 2

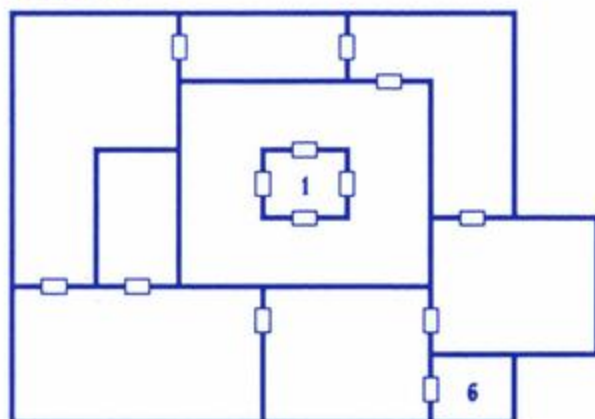

### Level 3

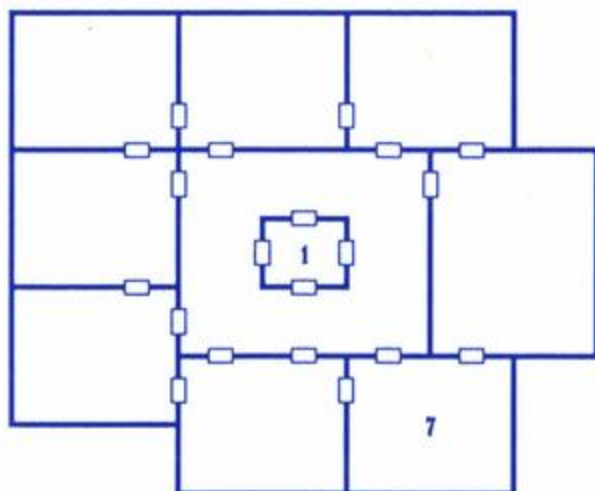

KEY



Wall



Door

The Sun King will then ask the team to take over the Doomsday Laser and deliver it to his control, so he can rule the solar system instead of merely one Mariposa. If the team doesn't agree, it is permanently ushered out of the audience chamber. Even though the team intends to destroy the device, it should agree to cooperate with the Sun King... for now.

The Sun King will then deactivate the weapons in the core so the team can climb safely to the topmost portion of the Mariposa.

- 4: The door to the audience chamber is closely guarded. The team won't be allowed in until it brings three coins (from locations 5, 6 and 7) as gifts to the Sun King. If it was thrown out of the chamber for a breach of manners, it will be admitted one more time for a chance to apologize. If it ever failed to apologize, there is no way to get past this door.
- 5: A security robot is doing maintenance cleaning here, and is about to vacuum up a copper coin required to get into the Sun King's chamber. The team may grab the coin, fight, or leave. If the team fights, it will face security robots, and automatically receive the coin upon winning the battle. If a character tries to grab the coin, the character with the highest Pickpocket Skill should make the attempt. If he succeeds, the team gets the coin and may leave the room without fighting. If he fails, the team fights the security robots for the coin.
- 6: This extremely cluttered closet houses the silver coin. Keep searching and it will eventually surface.
- 7: The gold coin is mounted on a plaque. Unfortunately the plaque is in a room filled with deactivated security robots. The team must have this coin.

Level 5



Level 6



Level 7



Level 8

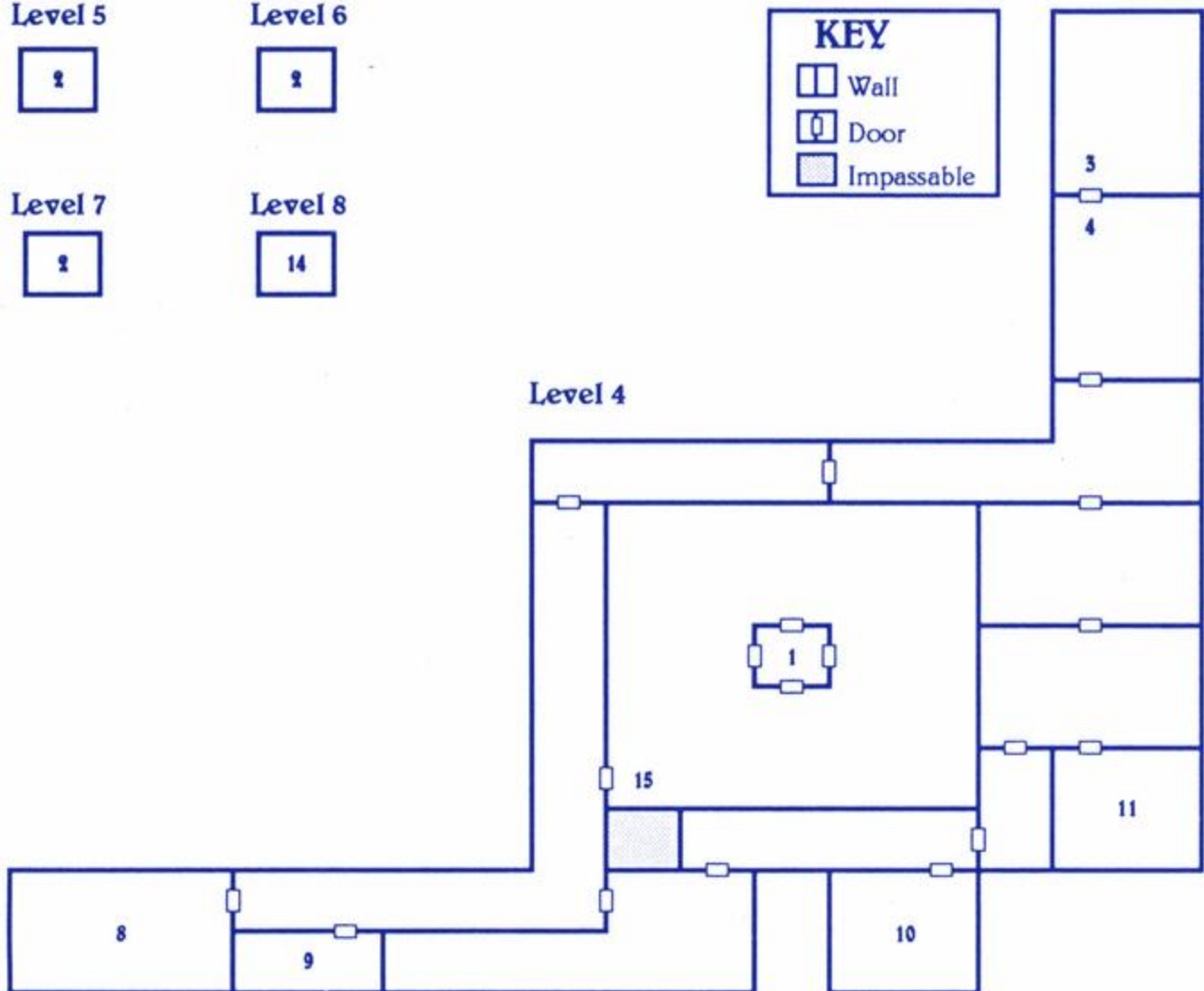

The character with the highest Bypass Security Skill should try to get the coin. If he succeeds, the team may leave the room without disturbing the robots. If he fails, he sets off an alarm and the team must battle robots before getting the coin.

- 8:** This is the Sun King's bedroom.
- 9:** This is the Sun King's wardrobe.
- 10:** This is the Sun King's sitting room. His chess set reflects his political stance.
- 11:** This is the aviary. Opening the door allows all the birds to escape.
- 12:** This is the Weapons Control Center for the core. The Sun King is the only one who can successfully disarm the

defenses. When the weapons are disarmed, the light above the console will be green.

- 13:** The team enters the core here. It may rise, or leave the core. If it tries to descend, the team will face endless battles with troops below until finally retreating back up the core... or dying.
- 14:** This is the top of the core, leading to the Mercurian Finale.
- 15:** This guard will follow the team up the core to the Mercurian finale if it managed to befriend the Sun King. His job is to 'see that the Sun King's wishes are met.'



## O. MERCURIAN FINALE

### Security Level

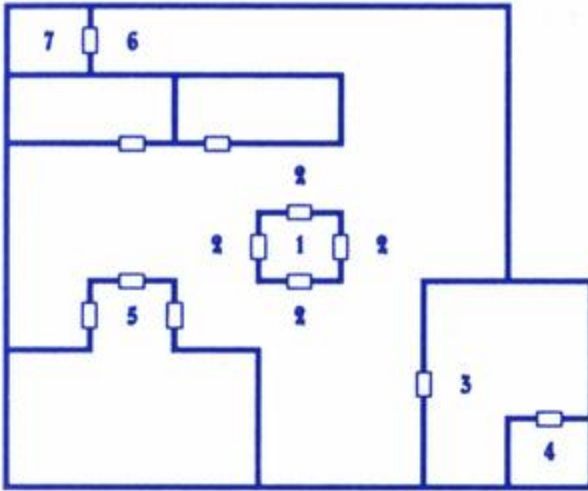

### Pod Control Level

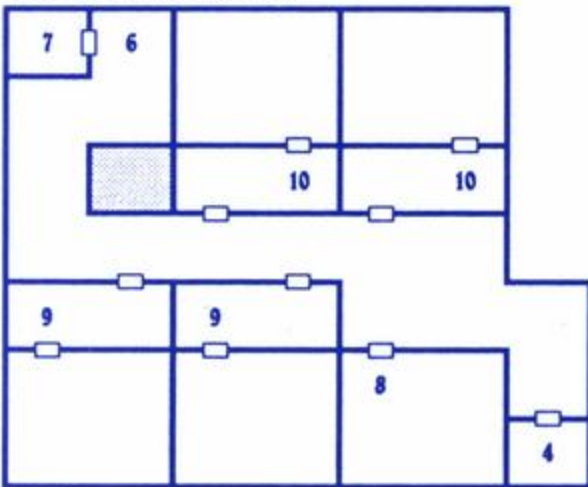

**KEY** □ Wall □ Door

befriended the Sun King in the core and his minion sees the self-destruct sequence begin, he reports the team's treachery to the Sun King, who sends squads of Mercurian warriors and Mercurian security robots.

### Locations:

- 1:** This is the top of the zero-gravity core. Do not go down the core if the team has received the message in location 2 — the countdown will not stop! If the self-destruct sequence has begun, the team will no longer have the option of climbing down the core.
- 2:** The first time the team enters any of these squares it will be notified that the Doomsday Laser is preparing to fire at Earth. The only way to prevent this is to go to the power station at location 11, and interrupt the system's power. The team only has a certain amount of time to do this before Wilma Deering will ram her ship into the device to stop it herself. The team will die in that explosion. Therefore, go to the power station as quickly as possible.
- 3:** Guards are here watching the elevator. If the team surrenders, it will be imprisoned until the countdown is completed and Wilma begins her suicide run. If it runs, the guards will set the alarm and begin the random attacks. If the team fights and defeats the guards it may enter the elevator.
- 4:** This elevator will only go to the security or pod level: the weapons control level is restricted. After the power is disabled, the elevator won't work at all.
- 5:** This security office monitors the condition of the station. It will have different readouts depending on what you have achieved so far.

## O. MERCURIAN FINALE

**Summary:** This is the team's chance to destroy the Doomsday Laser. When it arrives, it first must interrupt the system's power to halt the 'countdown to doomsday'... the destruction of Earth. After that, the team activates the self-destruct mechanism and must escape the Mariposa before the explosion.

**Random Encounters:** There are no random encounters here until one of the security alarms is activated, after which the team will be attacked by RAM security robots at random intervals. If the team

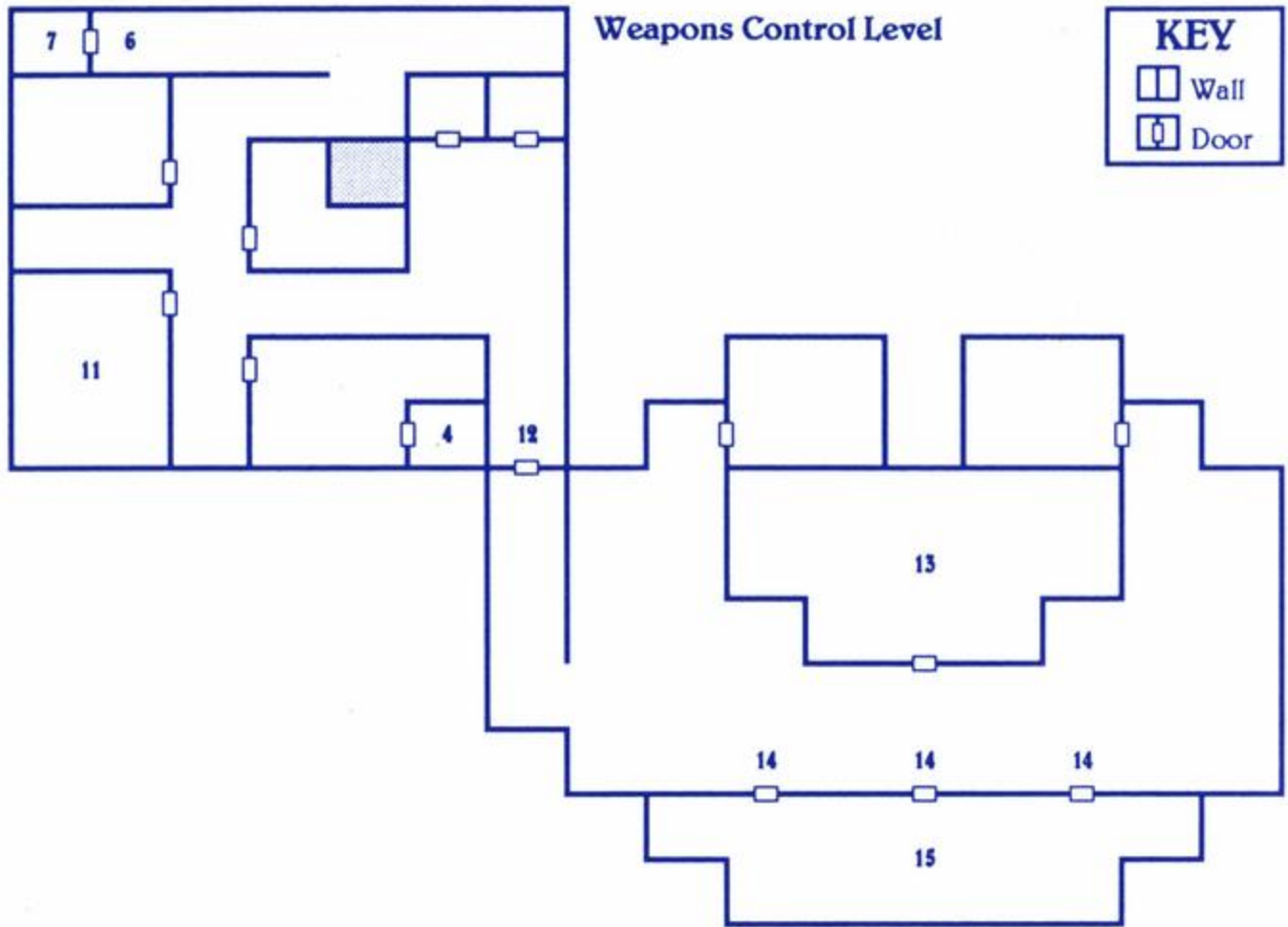

- 6:** Behind these emergency doors is a staircase that goes up to all three levels of the Mariposa top. Opening the door will start an alarm, which activates the random encounters. However, the staircase is the only way to reach the topmost level, where the weapons control center and the power station are located.
- 7:** The staircase goes to all three levels.
- 8:** This is the pod control center. It will only activate after the self-destruct sequence has begun. After starting the sequence, the team must enter this room before it can take a pod. Scot.dos will make sure the team has security clearance to enter one of the pods.
- 9:** After the team completes location 8, either of these pods can be used to escape the Mariposa. The team can't enter before completing location 8.
- 10:** The team cannot enter either of these pods.
- 11:** The team must disable the station's power from here before the countdown to Earth's destruction runs out. The character with the highest Repair Electrical skill should adjust the power boards. If he fails, the team will be zapped with electricity for damage, but the station's power will be interrupted anyway.
- If the characters reenter this room after disabling the power, they will have a fight with a group of RAM technicians trying to repair the power boards.

- 12: This door requires the Retinal Lockpick the team got on Venus.
- 13: This is the viewing chamber for the Doomsday Laser.
- 14: The doors to the Weapons Control Center won't open until the team interrupts the system's power at location 11.
- 15: This is the Weapons Control Center. The team must defeat a large number of assault robots, RAM combat gennies and RAM technicians.

If the team befriended the Sun King in the core, his minion will tell him when the self-destruct sequence is started. The team will then begin to meet squads of Mercurian warriors.

After beginning the self-destruct sequence, the team has a very limited amount of time to get to an escape pod and leave the Mariposa before the Doomsday Laser explodes. Go immediately to a pod control center (take the stairs) and then to one of the pods at location 9.

**CONGRATULATIONS!  
THE EARTH IS SAVED!**

## MONSTERS: HOW TO DEAL WITH THEM



### ACID FROG

These giant Venusian gennies are immune to plasma, heat and gas. They spit acid over long distances, so beware. Acid Frogs may be friendly, so the team should not blindly attack them.



### SMALL EXPERIMENTAL COMBAT GENNIE (ECG)

These RAM horrors have very high Zero-G skills in combat. They are immune to gas and intimidation, and their attacks can cause partial paralysis.



### ACIDICIUM

These gennies are immune to dazzle grenades, gas, intimidation and stun. They also have a 50% chance of deflecting hand to hand or ranged attacks. They have a paralyzing attack.



### LARGE EXPERIMENTAL COMBAT GENNIE (ECG)

These also have high Zero-G skills, and are immune to gas and intimidation. Their attacks can cause instant death.



### DESERT APE

These Martian gennies are immune to plasma, heat and intimidation.



### HEXADILLO

Hexadillos are Martian grazing animals. They are immune to plasma and heat, but are no great threat.



### HYPER-CRAB

These RAM gennies have a weak attack and no immunities.



### HYPER-SCORP

Hyper-Scorps have no immunities, but their sting can cause death.



### SAND SQUID

Martian Sand Squids will lurk under the sand and leap out at the team, so have frequent surprise attacks. They are immune to plasma, heat and can cause death with their touch.



### HYPER-SNAKE

The fiercest of the Hyper series, Hyper-Snakes are immune to dazzle grenades, microwave, smart shells and stun.

They are noted for their remarkable speed and agility.



### SPACE RAT

These pests have immunity to dazzle grenades, gas, and smart shells. They have high dexterity, high Zero-G skill, and a 50% chance to dodge any attack.



### RAM GUARD DOG GENNIE

These gennies have paralyzing bites, and are fairly strong and dexterous.



### SWAMP HORNET

Venusian Swamp Hornets are immune to gas, but only have moderately damaging attacks. They will always attack in swarms, however, and can be deadly in large groups.



### ROBOTS

All types of robots are immune to dazzle grenades, gas, intimidation, microwave, smart shells and stun. They have increasingly more powerful armor and weapons as the game progresses.



### URSADDER

These repulsive Venusian gennies are immune to gas and intimidation. Like the Swamp Hornets, they attack in swarms.

## SHIP COMBAT TACTICS

When combat begins, be sure to place the Rocket Jock with the best Pilot Rocket Skill in command. To optimize your salvage chances, close with the enemy as quickly as possible and board. To board an enemy ship, it must have either no Controls, no Engines or no Fuel. Closing will also prevent the enemy's ship from fleeing. Any ship that retreats beyond range eight will escape.

The pilot controls the K-Cannon and Missiles and should target the Control system every round that he is within range. The other characters each control a laser, and they should target the enemy's Weapon system.

Whenever the reload option comes up for a character, he should use the option, and keep the K-Cannon and Missiles fully loaded.

Whenever Engine, Control or Hull systems on the team's ship goes below half of their starting value, one character should perform a Jury Rig on that system. If a K-Cannon or Missile is damaged, it should be immediately Jury Rigged.

Once the team boards the enemy ship, it should proceed immediately to the Engineering section. There are two control banks in Engineering that must be secured to win. If the Engine system has been destroyed, the team should head to the bridge.

If the team ever retreats back into its own ship, it will have to face a very large force of counter boarders. This will be a very difficult fight, so the team should only retreat as a last resort.

### LOG ENTRIES: TRUE OR FALSE?

The following log entries are true:

4, 7, 8, 10, 13, 14, 17, 21, 22, 27, 28, 29, 30, 34, 35, 36, 38, 39, 41, 43, 44, 45, 46, 50, 52, 53, 54, 55, 59, 60, 61, 62, 63, 66, 67, 68, 69, 70

## TACTICAL COMBAT TACTICS

The key information to remember is to protect the team's Medic. Move him out of sight of all enemies if possible. Without a conscious medic, no one will regain any hit points between battles, and soon all of the characters will be too weak to win a combat.

Always concentrate fire at the same target. An enemy with one hit point can fire as effectively as an enemy with full hit points.

Unless the enemy has grenades, the team should close to short range for its guns, using cover whenever possible. If the enemy is using grenade launchers, plasma throwers or rocket launchers, the team should spread out or get in between the enemies. If the team is equipped with these weapons, it should pull back and use them against concentrations of enemies.

The best weapons tend to be those with high rates of fire. Needle guns work against anything and six shots per round make them likely to inflict damage. Rocket pistols inflict the most damage, but their smart shells can be foiled by several enemies. Warriors who specialize in these weapons will be especially deadly.

Characters with poor armor classes should go behind cover. If the enemy is using lasers and the team is not, drop an aerosol grenade to protect the team. Also use chaff grenades if the enemy is using rocket pistols or rifles; grenades; or plasma throwers, and the team is not.

If a warrior has a high strength (18 or better), equip him with a mono sword or polearm and have him close to melee the enemy. The additional damage makes him as effective as if he were equipped with a ranged weapon.

If the battle is going badly, try to pull the team through a doorway and set up out of sight. The enemy will tend to trickle through the doorway, allowing the team to slay them more effectively. Be sure to set the entire team to guard status. This will guarantee that the characters will shoot first.



# SURVIVE THE PERILS OF THE SOLAR SYSTEM...

**E**ven though you've defeated the deadly swarm of swamp hornets on Venus, the real dangers await you on Mars. There you'll face desert apes, sand squids and other, even greater challenges!

## Now what?

No need to panic. You've got the **COUNTDOWN TO DOOMSDAY CLUE BOOK** to get you through another day of rocketing around the solar system.

Here's what's inside:

- \* Detailed maps for the entire game—including locations of all major events in the adventure.
- \* Combat tips that allow you to overcome even your toughest foes.
- \* Lists of all the opponents in the game with information on their strengths and weaknesses.
- \* Lists of which skills are useful and where to use them.

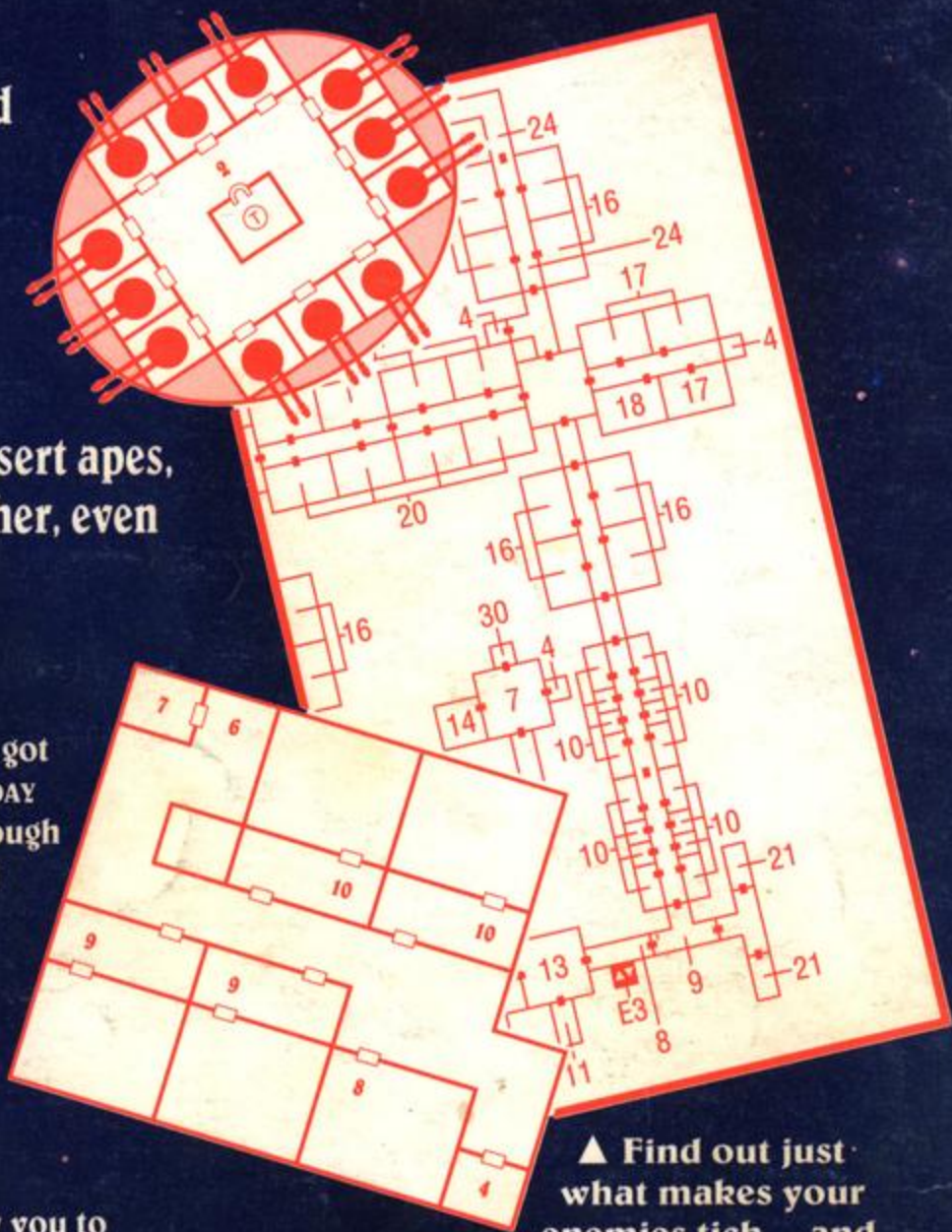

▲ Find out just what makes your enemies tick... and the best way to get to the **Doomsday Laser** with detailed maps of all the hot spots in the solar system!

BUCK ROGERS and XXVc are trademarks used under license from The Dille Family Trust. The TSR logo is a trademark owned by and used under license from TSR, Inc. ©1990 The Dille Family Trust. ©1990 TSR, Inc. ©1990 Strategic Simulations, Inc. All rights reserved.

MADE IN U.S.A.

