

# POPULOUS II

TRIALS OF THE OLYMPIAN GODS

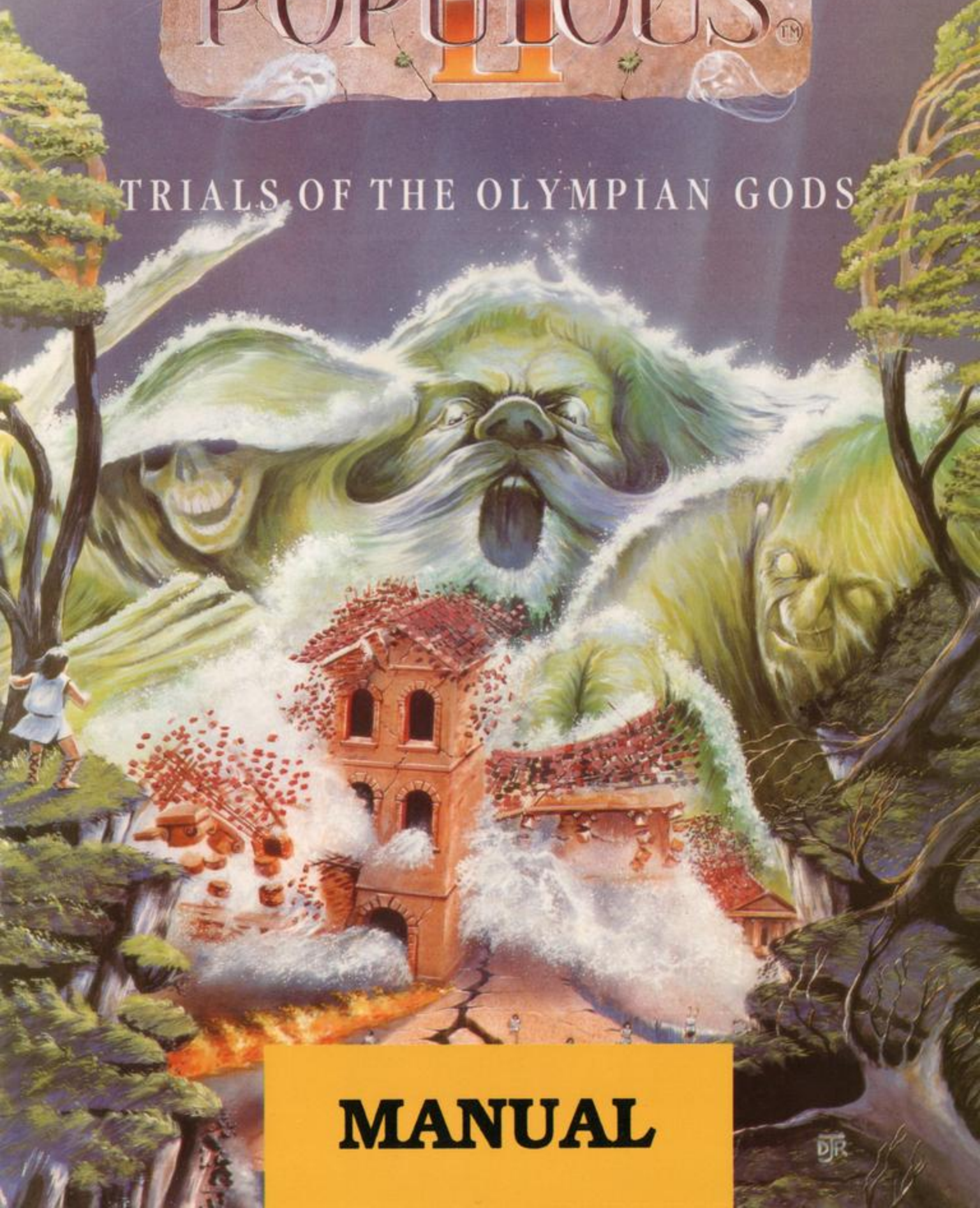

**MANUAL**

DJR



## ARTIST'S BIOGRAPHY



From left to right: Alex Trowers, Sean Cooper,  
Kevin Donkin, Gary Carr, Peter Molyneux,  
Glenn Corpes, Paul McLaughlin

**NOTICE FROM:** The West End Sanatorium

**DATELINE:** 11.20.91

**TO:** Headquarters2

The lunatics took over the asylum two weeks ago. Nine have escaped. We believe they are masquerading as the software development group Bullfrog Productions, Ltd. in Guildford, England. They are dangerously good at pretending they are excellent software developers, having released PowerMonger™ and Populous™ just before they were committed.

Find them quickly. Who knows what hits they'll release next. Read the following descriptions of each of the escapees to make your search a little easier.

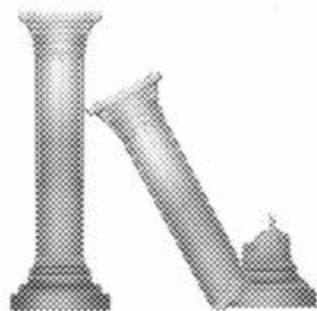

### ***PETER MOLYNEUX***

**Born in:** Accra, Ghana, Africa

**Age:** 33 years

**Ambitions:** to persevere in his struggle to be “normal” despite acute megalomania

**Favourite Toy:** Japanese push-button pencil case (with fuel injection)

**Favourite Music to Eat Apple sauce to:** Sombre symphonies by Gustav Mahler

### ***LES EDGAR***

**Place of Birth:** Unknown

**Age:** Possibly 30's

**Ambitions:** Bodily harming the person who keeps dropping fast food wrappers in his garden

**Favourite Weapon:** Aston Martin Volante

**Best Attribute:** Ability to sign cheques like he means it

### ***ALEX TROWERS***

**Born in:** A caravan by the M-3 motorway, England

**Age:** 18

**Favourite TV Monster:** King Kong

**Favourite Possessions:** Jacket, Uzi BB Gun, and intimidating shades

**Favourite Thing to Say to Total Strangers:** “I’ll be back.”

### ***GARY CARR***

**Born in:** Castleford, West Yorkshire, England

**Age:** 25

**Ambitions:** Money in the bank at the end of the month

**Favourite TV monster:** Margaret Thatcher

**Favourite Possession:** An old hairbrush for scratching between his toes

### ***PAUL MCLAUGHLIN***

**Born in:** Waterford, Ireland

**Age:** 27

**Favourite Thing to Say to Total Strangers:** “I may be drunk madame, but you are ugly and I shall be sober in the morning.”

**Secret Dreams:** To be gum in Jabba the Hut’s mouth

**Favourite Music to Take Medication by:** Handel



***BRYON HAPGOOD***

**Born in:** Harlow, Essex, England

**Age:** 22

**Favourite Music:** Mozart

**Favourite Thing to Scream at Strangers:** "You never get enough of what you don't need!"

**Secret Desire:** To be gum in a piranha's mouth

***GLENN CORPES***

**Born in:** Guildford, England

**Age:** 28

**Life Goal:** Tetris — Level 16, depth 5.

**Favourite Toy:** Sound Burger, an un-portable record player

**Favourite Possession Overall:** A silver ankh

***SEAN COOPER***

**Born in:** Wegberg, Dusseldorf, Germany

**Age:** 17

**Favourite TV Show:** None

**Secret Desire:** None

**Favourite Possession:** Packet of ciggys

***KEVIN DONKIN***

**Born in:** Aldershot, England

**Age:** 27

**Favourite Vehicle:** A go-kart

**Goals in life:** None

**Favourite Thing to Say to Total Strangers:** "Just the fax ma'am"

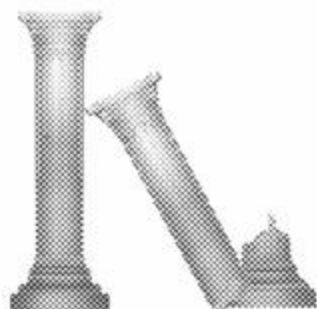

# THE MAKING OF FAGGOD



BUT HE NEVER SEEMED  
SATISFIED COMING TO  
THEM IN THE FORM OF  
OF A GOD



INSTEAD HE  
CHOSE ...

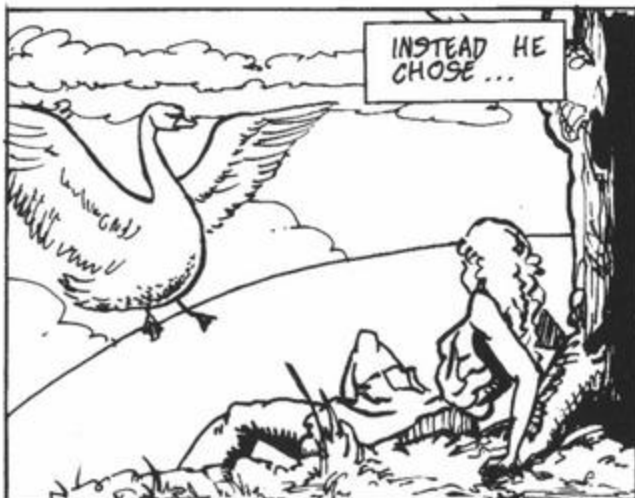

OTHER MEANS OF  
SEDUCTION!



**N**





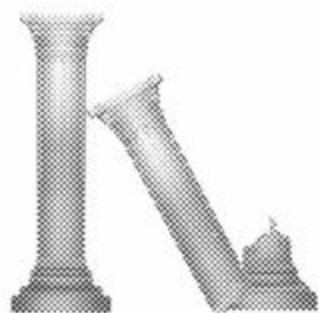



# CONTENTS

|                                    |    |
|------------------------------------|----|
| WELCOME TO POPULOUS II .....       | 10 |
| IN THE BEGINNING .....             | 12 |
| GAME MENU .....                    | 21 |
| CONQUERING WORLDS .....            | 27 |
| COLOSSEUM .....                    | 27 |
| CLOSE-UP MAP .....                 | 29 |
| WORLD MAP .....                    | 31 |
| RAISING AND LOWERING LAND .....    | 31 |
| SETTLEMENTS AND SPROGGING.....     | 32 |
| MANA .....                         | 33 |
| MANA GAUGE .....                   | 33 |
| PAPAL MAGNETS .....                | 33 |
| INFLUENCING BEHAVIOUR .....        | 34 |
| WORSHIPPERS AND WALKERS .....      | 34 |
| SOUNDS .....                       | 34 |
| QUITTING A WORLD .....             | 35 |
| COMMANDS .....                     | 36 |
| BASIC COMMANDS .....               | 36 |
| DIVINE INTERVENTION COMMANDS ..... | 43 |
| WINNING.....                       | 53 |
| EXPERIENCE POINTS .....            | 53 |
| GAME SUMMARY SCREEN .....          | 54 |
| SAVING A GAME .....                | 54 |
| STRATEGIES AND TECHNIQUES .....    | 55 |
| KEYBOARD EQUIVALENTS.....          | 56 |
| PLAYING BY SERIAL LINK .....       | 57 |
| LOG PASSWORDS AND WORLD NAMES..... | 62 |



# WELCOME TO POPULOUS II

## OVERVIEW

As one of the many sons of Zeus the All-Father, you demand your rightful place among the gods on Mount Olympus. But Zeus isn't about to give you your inheritance just for the asking. You must prove your worthiness by defeating the 32 divine opponents who rule the 1000 worlds of Populous II.

## START WITH THE COMMAND SUMMARY CARD

The Command Summary Card included in your package contains complete instructions on how to load Populous II.

## CREATE YOUR DEITY

Your first task is to create the kind of deity that you want to be. You choose the eyes, mouth and headpiece that indicate whether you're benevolent and wise, fierce and war-like, brutish and cruel, or some bizarre combination of these characteristics.

Your god's personality affects how opponents react to you. For example, if your deity looks aggressive, your opponent wages war harder. If your deity looks like a scholar, the combat is more subtle and clever.



## CONQUEST GAMES ARE PART OF A SERIES

There are two ways to play Populous II: Conquest Games and Custom Games. In Conquest mode, you must conquer a series of worlds. Each world gets progressively harder as you face tougher terrains, stronger gods, and more potent divine powers (known as Divine Intervention Effects).



CONQUEST GAME

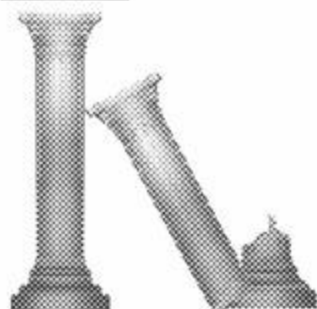

## EACH CONQUEST EARNS YOU EXPERIENCE

If you played a Conquest Game well, you're awarded experience. After each conquest, you can exchange your experience for greater power in the six forces of nature. You can decide to concentrate on a particular element — becoming, say, a fire god — or you can spread your experience over all the forces.



## THE ULTIMATE GOAL — DEFEAT ZEUS

The final battle in the Conquest series is against your father and supreme master, Zeus. Defeat Zeus and you can take your seat among the gods.

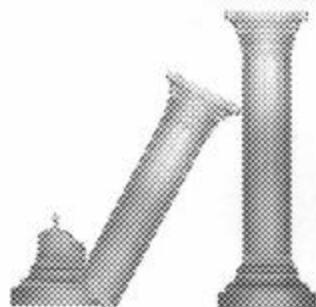

## CUSTOM GAMES LET YOU CALL THE SHOTS

In Custom mode, play a random land with all the effects you have earned in your Conquest games. For example, if you have played three Conquest games and seen a variety of different effects, in Custom mode you'll be able to play a game with all those effects combined.

### CUSTOM GAME

## CONQUEST PROGRESS AFFECTS CUSTOM GAMES

In a Custom Game, the Divine Intervention Effects you can do are limited by your progress in the Conquest series — you can't do effects you haven't already used in a Conquest Game. This is the only limitation to the kind of Custom Game you can make.

## IN THE BEGINNING...

This section will help you get started by showing you the techniques and concepts you'll need to conquer the first world in the Conquest series.

### CREATE A GOD

From the Game Menu, left-click on Create Your Deity. The Create Deity screen appears:



Click Proceed to return to the Game Menu.

You'll start the game with five lightning bolts of experience. Apply them to one of the six element icons by left-clicking on any of the elements. You can spread your experience around by clicking once on five different icons, or you can build up your strength in one by clicking five times on one element.



After the end of each battle, you can earn more lightning bolts of experience to build up your experience in the other elements even further.

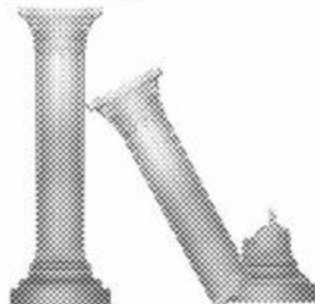



## CHOOSE A CONQUEST GAME

Left-click on Conquest Game at the game menu. The Next Conquest screen appears:

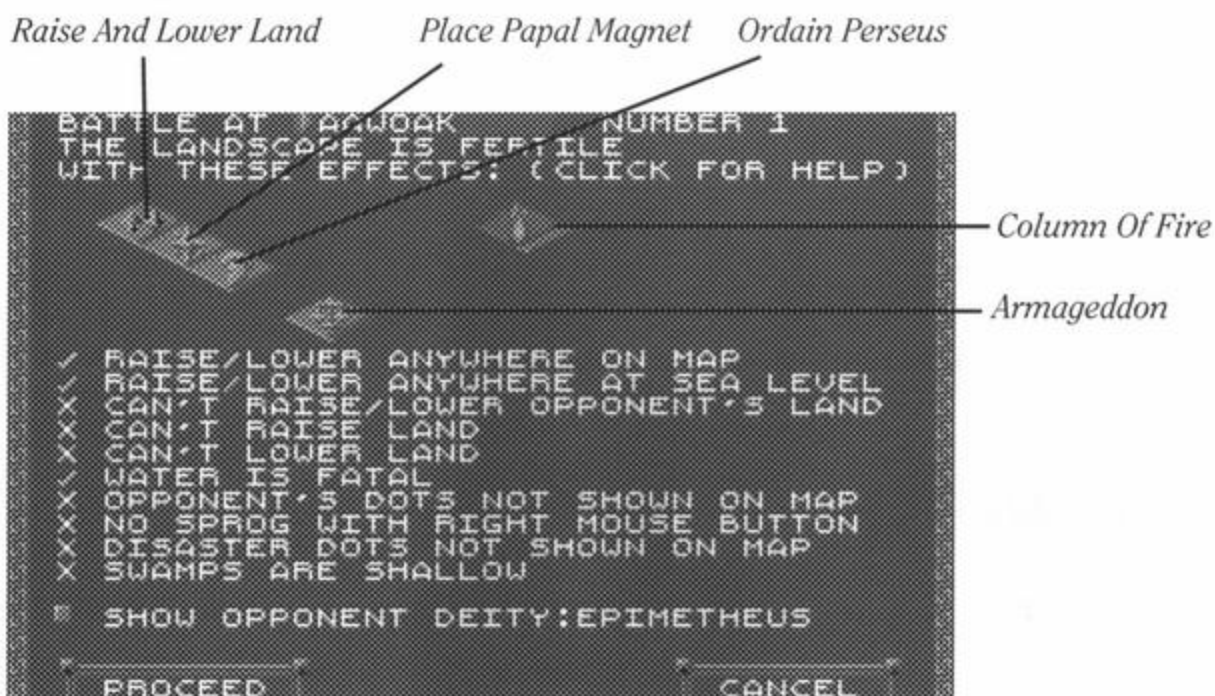

The Next Conquest screen shows you which Divine Intervention Effects and special rules apply to the world you're about to conquer. In this first world you can only do five Effects: Raise And Lower Land, Place Papal Magnet, Ordain Perseus, Armageddon, and Column Of Fire. A tick (✓) indicates that a special rule applies to you in this world — for example, the tick next to "Water Is Fatal" indicates that people always drown if they fall in water.

There are 1000 worlds in the Conquest series. Each world has a number and a name. The number for the first world in the series is 0; its name is DOEGAC. Each time you conquer a world, Zeus will give you the name of the next world he wants you to do battle on. Always write down the name of any world Zeus gives you. If you quit Populous II, you'll need this name to continue the Conquest series where you left off.

Click proceed to begin the game.

## PAUSING THE GAME

Once the battle starts, you'll want to pause the game from time to time so you can follow the tutorial. To pause the game, press the F10 key. To resume the game, press F10 again.



## THE BATTLE BEGINS

When the game begins, you're looking down at your worshippers.

**The World Map** is a view of the entire world you're currently on. Good and Bad populations inhabit the world usually on opposite sides of the map.

**The Close-Up Map** is a magnified view of a point on the World Map. All divine activities are carried out here.

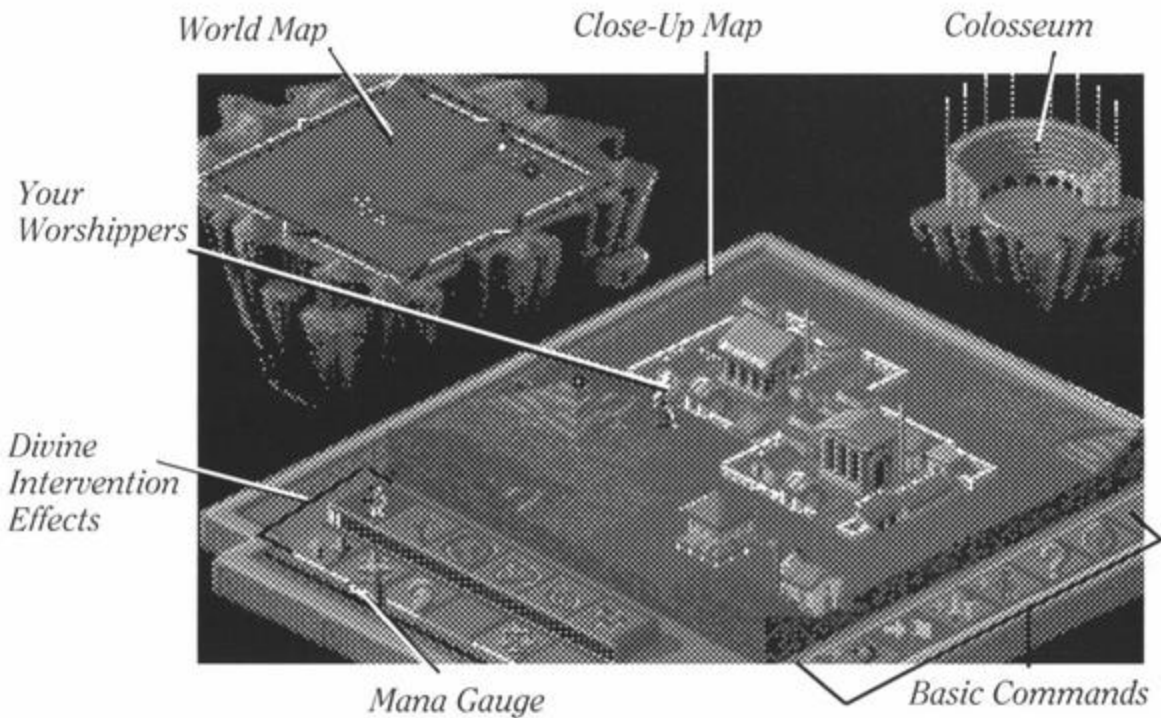

**Walkers** represent a number of people wandering the land as a tribe seeking to establish well-populated settlements. Walkers need shelter against the climate and they'll settle on any piece of flat land that can support them. When they settle, they create dwellings.

**Divine Intervention Effects** are an arsenal of awesome powers and potent disasters. There are six categories or elements, each with five individual Effects. The Effects you can do depend on the world you're fighting on.



**The Mana Gauge** measures your Mana. Mana is a reservoir of power you can use to do Effects. Mana comes from the pious worship of your followers — the more worshippers you have, the greater your Mana. The red line at the base of the Mana Gauge indicates your total Mana. The pointer indicates which Effects you can currently do.

Right now you only have enough Mana to raise and lower land. Occasionally you'll use up your mana and won't be able to raise or lower land, but don't worry. As you help your people multiply, your Mana will increase.



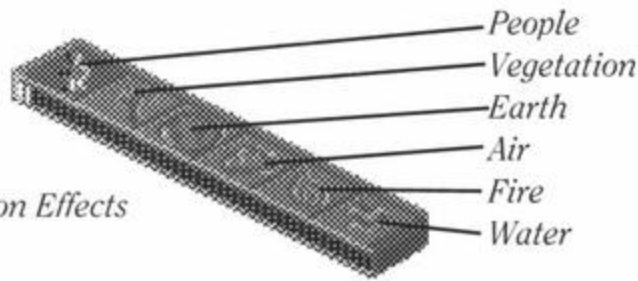

*Divine Intervention Effects*

**The Basic Commands** let you influence the general behaviour of your followers, get information on populations and settlements, and bring up the Game Requester.

**The Colosseum** is a population indicator for both Good and Bad worshippers. As populations change, the Colosseum fills and empties to reflect the fluctuating numbers of dwellers. Good populations appear in blue — Bad populations appear in red. The Colosseum can also be used to track walkers and settlements and get information on their strength and inventions.

### CHANGING YOUR VIEW

Changing your view is fundamental to playing Populous. There are several ways to change your view. The easiest is to scroll with the **cursor keys** or the **numeric keypad**.

The World Map can also be used to change your view. The area you're currently viewing is marked with a black diamond:

Point to the World Map and click a mouse button. A right-click jumps your view to the spot you're pointing to. A left-click moves your view one increment in that direction.

You can also scroll your view by clicking on the directional arrows around the World Map. The longer you hold down the mouse button, the more the map scrolls.



*Directional Arrows*

*Current Close-Up View*



## FLATTEN LAND

Your followers need flat lands to farm and settle on, so the first thing you should do is flatten the landscape around their settlements. The lay of the land is on a grid of squares, so you'll raise and lower land square by square. Note: on some worlds you won't be able to raise and/or lower on your or your enemies land.

To raise a square of land, move the diamond cursor to the centre of the square and left-click.

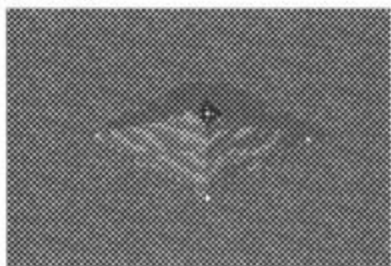

To lower a square of land, move the diamond cursor to the centre of the square and right-click.

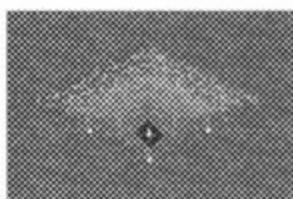

## CREATE LARGE SETTLEMENTS

Creating new settlements is fundamental to winning a world. Settlements grow according to the amount of farmland around them — the more farmland, the bigger the settlement.

The biggest settlements are castles. Castles increase your population the fastest, so initially they're the most valuable. Castles are also the most technologically advanced, and better weapons means your people will be more effective fighters. To create a castle, flatten the land widely around any dwelling.

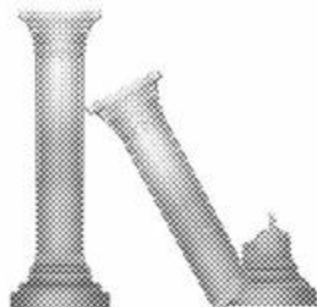



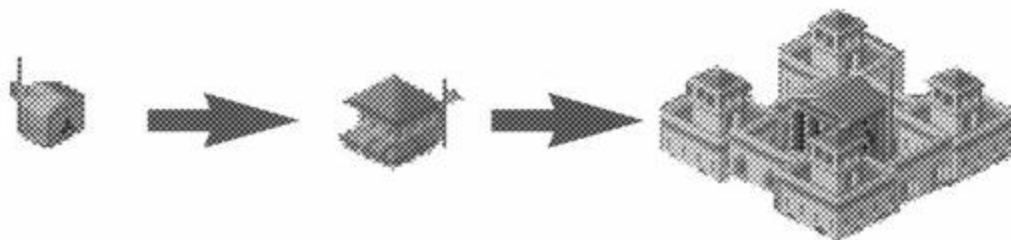

## SPROG EARLY, SPROG OFTEN

As a settlement fills with people, its flag rises. When its flag reaches the top, the settlement is full. At this point, a walker will automatically leave and go in search of a new place to settle.

In the early parts of a battle, you don't want to wait for your settlements to fill up before releasing walkers. The more large settlements you have, the faster your population will rise. This is where the technique of sprogging comes in. Sprogging is the most important means of spreading your population. When you sprog, you're commanding a settlement to send a portion of its population out into the world in search of a new home.

To sprog a walker from a dwelling, point to the centre of a dwelling and click the right mouse button. The diamond cursor must be on the exact centre of the dwelling:



*Place the diamond on the centre and right-click*

## COMPARE POPULATIONS

As you play, use the Colosseum to compare your population with the enemy's. The Good population appears as blue dots — Bad appears as red.

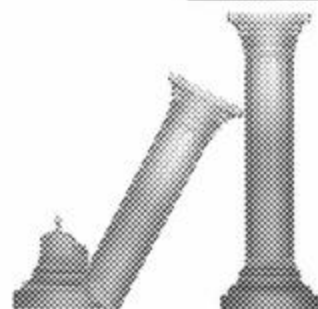
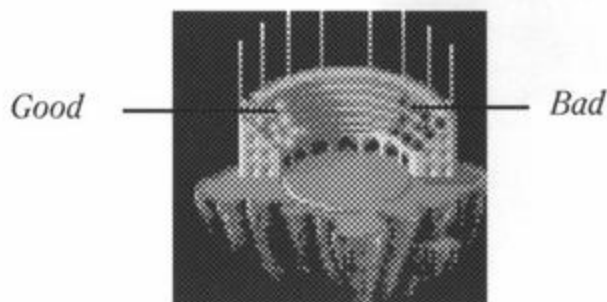

## USE DIVINE INTERVENTION EFFECTS

Once you've increased your Mana, you can use some of the five Effects available on DOEGAC. To switch between People Effects and Fire Effects, click on the appropriate icon.

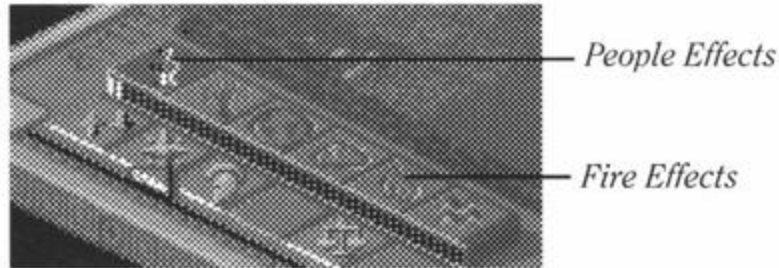

### ***FIRE EFFECTS***

The one Fire Effect available on DOEGAC is Fire Column, which starts a huge column of fire that moves across the land. To do a Fire Column, left-click on the Fire Column icon.

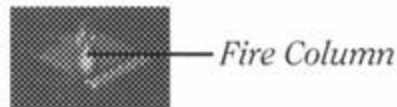

A small column on the pointer indicates that the column is now ready to be set down.

Move the cursor up the Close-Up Map and left-click to set the column down — it will appear in a somewhat random location. As dwellings burn, enemy worshippers perish. Any land that the column moves across will turn orange, indicating that it's scorched and ruined. The enemy will have to raise or lower the ruined land in order to make it arable farmland again.

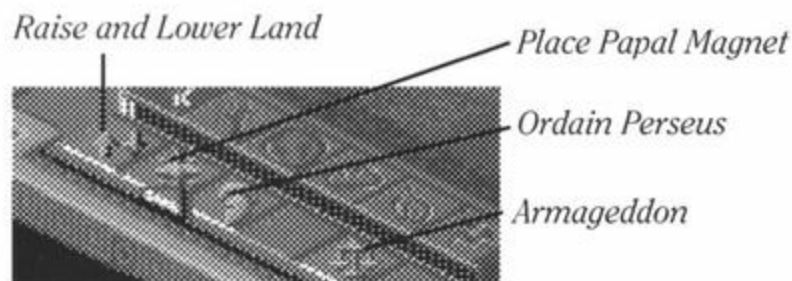
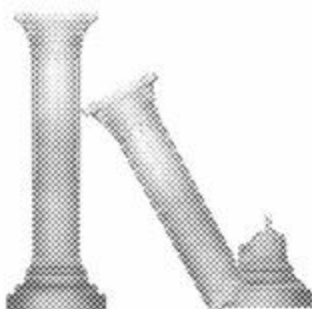

## **PEOPLE EFFECTS**

There are five People Effects available on DOEGAC.

- *Raise and Lower Land*: You know this one already. This lets you flatten landscape into farmland by raising and lowering land.
- *Place Papal Magnet*: This lets you place your papal magnet anywhere on the Close-Up Map. Left-click on this button, and then move your cursor to the Close-Up Map and left-click again. You cannot place your papal magnet unless you have a leader.
- *Ordain Perseus*: This changes your current leader into the hero Perseus, who marches through your opponent's land and destroys any settlements or people he encounters. Simply left-click on this icon to call the hero.
- *Armageddon*: This forces Good and Bad to fight until only one population survives. Only use this Effect when your population is significantly greater than the enemy's.

## **PAPAL MAGNETS**

The papal magnets are icons of worship for Good and Bad. You can move your magnet to Bad territory, then influence your worshippers to go to it and invade Bad settlements. The first of your walkers to encounter your magnet becomes your *leader*. Convert strong leaders into special walkers called *Heroes* with your papal magnet. You cannot place your papal magnet unless you have a leader.

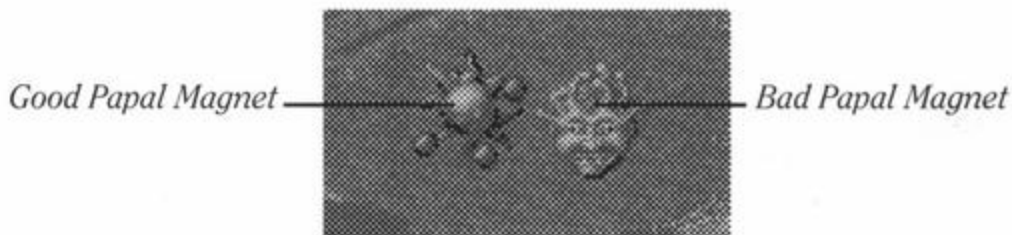

## USE INFLUENCE BEHAVIOUR COMMANDS TO MOVE PEOPLE

Use the Influence Behaviour Commands to influence the behaviour of your followers. The Influence Behaviour commands are available on every world and can be used without cost to Mana.



- *Go to Papal Magnet*: Influence your people to find their ordained leader and follow him to the Papal Magnet. You can always find the leader by right-clicking on this option. Use this option to draw your leader and worshippers together, then turn your leader into a hero. If you like.
- *Settle*: Influence your walkers to build new dwellings and your people to reproduce. To encourage faster settling, sprog worshippers from their dwellings by right-clicking on any house.
- *Fight*: Encourage your walkers to attack Bad settlements and worshippers. Fight also encourages your people to settle and produce more walkers for battle.
- *Gather Together*: Encourage your walkers to walk toward each other and combine into one stronger walker. Note that each walker represents a group of people, so when your walkers are gathering together, tribes are actually combining to make a larger troop. Use this behaviour when you want to build and strengthen walkers. This option also influences your people to settle as they come together.





# GAME MENU

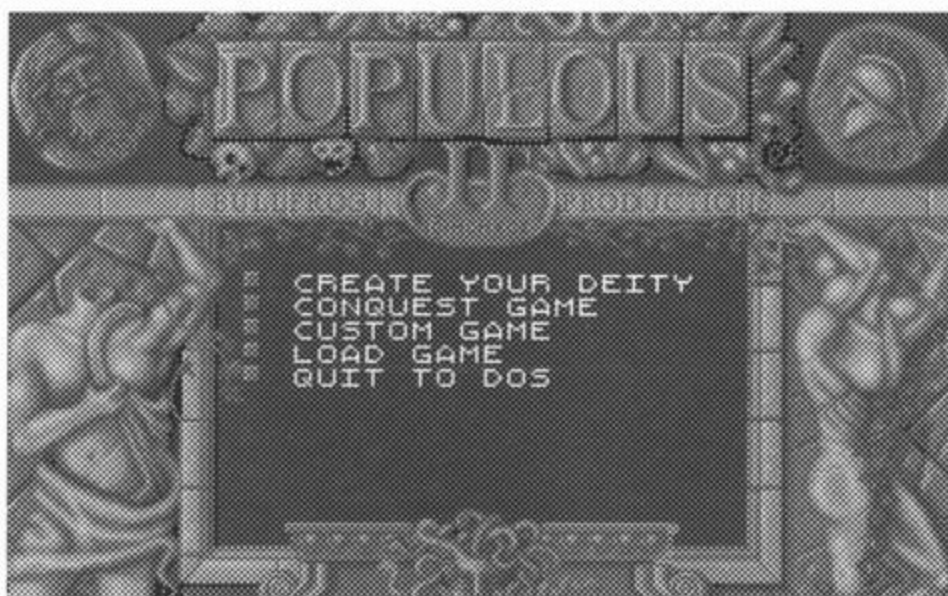

*Left-click an option in the Game Menu*

## CREATE YOUR DEITY

Lets you create and name your deity and assign any experience you've earned to one of the six elements.



*Left-click on Proceed to return to the Game Menu*



## NAMING YOUR DEITY

*To name your deity:*

1. Left-click on the name bar. A flashing dot appears.
2. Type the name of your deity and press **Return**.

## CREATING YOUR DEITY

Create your deity's looks carefully because they'll effect the way your opponent god battles you. Choose a scholar's hat and wise eyes for clever combat, or a warriors helmet and angry eyes for a ruthless battle experience.

*To create your deity:*

1. Left-click on a selection arrow next to the feature you want to change. Keep clicking to cycle through the various features.
2. If you need to back up, click the selection arrow opposite the one you're using.

Choose your eyes, headpiece, and face carefully — your appearance actually affects your opponent's reactions.

## ASSIGNING EXPERIENCE

*To assign any experience you've earned:*

1. Point to one of the six elements and left-click once for each lightning bolt you want to assign.  
The right half of the element icon turns gold one increment for each lightning bolt you assign. When the right half is full, the left half turns gold one increment and the right half goes dark again.
2. *Write down your password.* You can re-enter this password in the same slot next time you want to restart this game.

## CONQUEST GAME

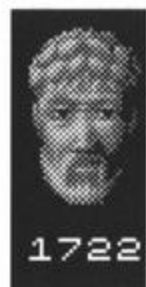

Choose **Conquest Game** to play all the worlds in progression of difficulty. As you progress and gain experience, opponents get stronger and more crafty, landscapes get more harsh, options are restricted, and available Effects change.

There are 1000 worlds in Populous II, but you don't have to complete each one in order to face Zeus in the final combat. If you demonstrate sufficient skill, you can skip worlds — for example, you could go from world 0 to world 18, and from there go to world 26, and so on.



## NEXT CONQUEST SCREEN

When you choose Conquest Game, the Next Conquest screen appears:

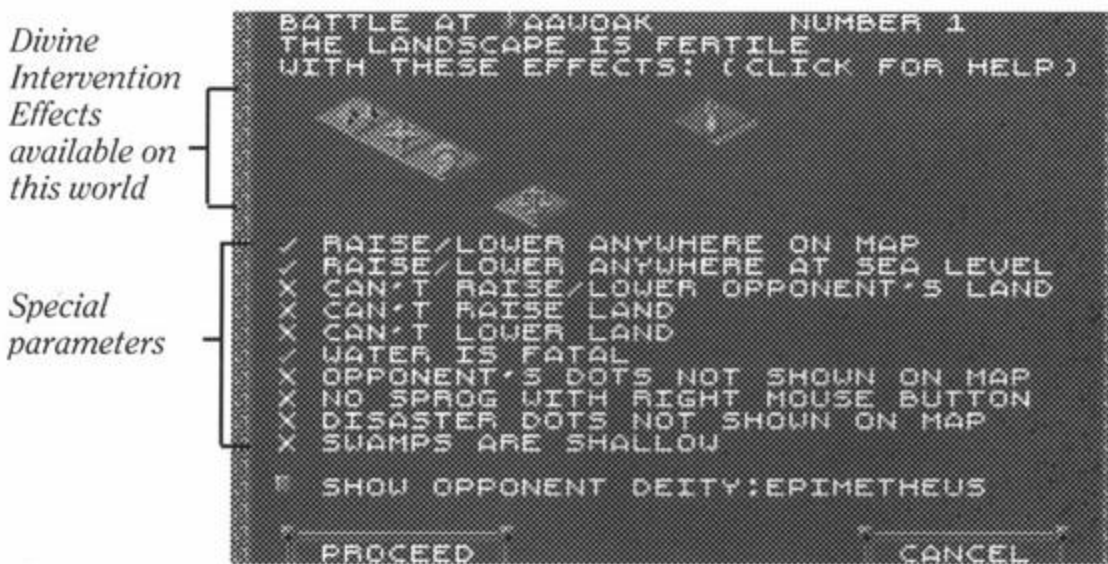

The Next Conquest screen shows you which Divine Intervention Effects and special parameters apply to the world you're about to conquer. A tick (✓) indicates that a special rule applies to both you and your opponent in this world — for example, the tick next to “Water Is Fatal” indicates that people will always drown if they fall in water. An X indicates that a rule does not apply.

*The following rules may be in effect on certain worlds:*

### **RAISE/LOWER ANYWHERE ON MAP**

- ✓ You can raise and lower land regardless of whether a settlement is in view on the Close-Up Map.
- ✗ You can only raise and lower land when a settlement is in view on the Close-Up Map.

### **RAISE/LOWER ANYWHERE AT SEA LEVEL**

- ✓ You can only raise and lower land at sea level.
- ✗ You can not raise and lower land at sea level view on the Close-Up Map.

### **CAN'T RAISE/LOWER OPPONENT'S LAND**

- ✓ You cannot raise or lower your opponent's land.
- ✗ You can raise and lower your opponent's land.

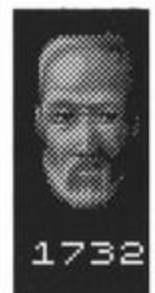

**CAN'T RAISE LAND**

- ✓ You cannot raise land.
- ✗ You can raise land.

**CAN'T LOWER LAND**

- ✓ You cannot lower land.
- ✗ You can lower land.

**WATER IS FATAL**

- ✓ Your people automatically drown in water.
- ✗ Your people can be saved if they're dropped in water.

**OPPONENT'S DOTS NOT SHOWN ON MAP**

- ✓ You can see opponents on the World Map.
- ✗ You cannot see opponents on the World Map.

**NO SPROG WITH RIGHT MOUSE BUTTON**

- ✓ Right-clicking lowers land no matter where the cursor is on the map.
- ✗ Right-clicking on the centre of a dwelling sprogs a walker.

**DISASTER DOTS NOT SHOWN ON MAP**

- ✓ You cannot see disaster effects on the World Map.
- ✗ You can see disaster effects on the World Map.

**SWAMPS ARE SHALLOW**

- ✓ When a person from this side falls in a swamp, the swamp is "filled" and disappears.
- ✗ No matter how many people from this side fall in a swamp, it will never be filled.

**SHOW OPPONENT DEITY:**

Left-click on the green button to read a description of your current opponent.

**PROCEED**

Left-click on Proceed to begin the conquest.

**CANCEL**

Left-click on Cancel to return to the Game Menu.



## NAMES

Each time you start a world, you receive the name of the next world you are to conquer. *Always write down this name.* If you quit Populous II, this is the only way you can resume the Conquest series where you left off.

*To resume the Conquest series where you left off:*

1. Select **Conquest Game** from the Game Menu. The Next Conquest game appears.
2. Click on the **Battle At** bar. A flashing dot appears.
3. Type the name of next world for you to conquer and press **Return**.

## CUSTOM GAME

Through playing a few conquest games, you experience different combinations of Divine Intervention Effects and earn new ones. Choose Custom Game to play a random landscape using all the Effects you've earned so far in your Conquest games. CUSTOM GAMES WON'T ADVANCE YOU TOWARD FINAL VICTORY AGAINST ZEUS.

## ADJUSTING GAMEPLAY

Custom Games start out very hard, so to adjust it to your level:



1. Left-click on the Game Requester icon to bring up the Game Requester.
2. Left-click on Game Options to bring up the Game Options Requester.
3. Left-click on any of the options to change any of the special parameters for Good (you).

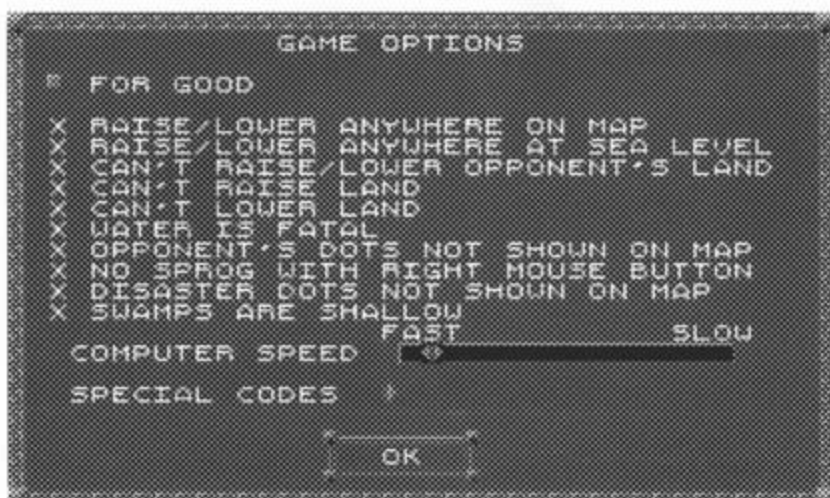



4. Left-click on the green button next to For Good to change it to For Bad. Now left-click on any of the options to change any of the special parameters for your opponent. Initially your opponent can create and destroy land very fast, so you may want to alter Bad's abilities to raise and lower land and slow your opponent down with the COMPUTER SPEED bar.
5. Left-click on **OK** to return to the game.

### **PAINT MAP MODE**

The Paint Map mode lets you customise games further by letting you:

- Change maps and landscapes
- Adjust Mana levels for both sides
- Set down walkers, trees, and rocks on the map

For details on the different Paint Map options, see Game Requester under Basic Commands.

### **LOAD GAME**

Load a saved game. See your Command Summary Card included in your package for instructions about how to load a saved game.

### **QUIT TO DOS**

Exit to DOS.

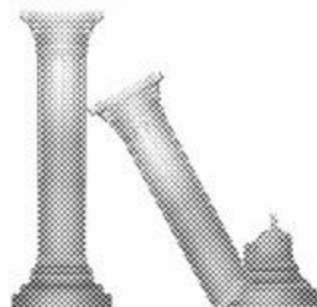

# CONQUERING WORLDS

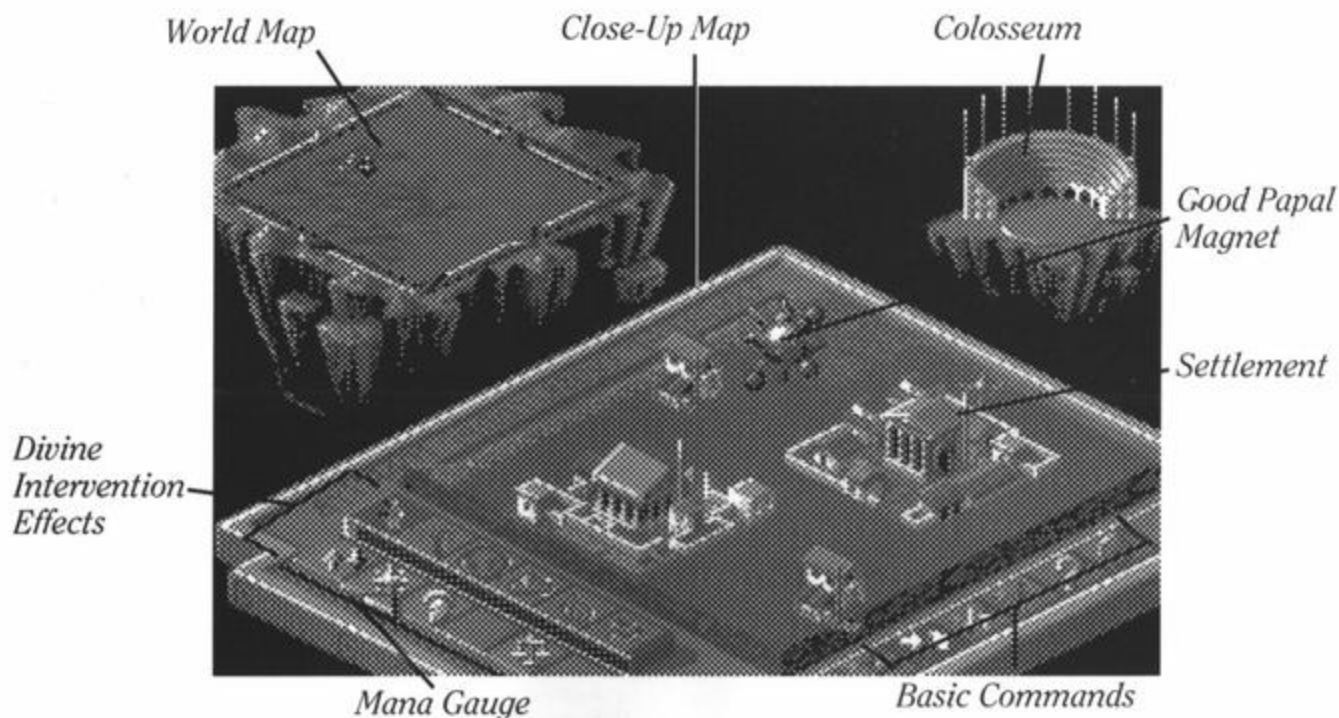

## COLOSSEUM

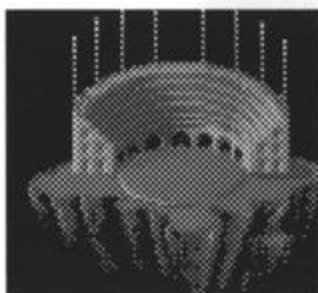

The colosseum reflects population and level of technology of the world, a settlement, or a walker.

### **WORLD POPULATION**

Use the colosseum to check up on the world's population from time to time. As the Good (blue) and Bad (red) populations grow, representatives of both sides enter the colosseum. Good worshippers dressed in blue sit on the left, Bad worshippers dressed in red sit on the right. The blue and red representatives of the general population never leave. They are always showing and always represent only the total population of the world.



## SETTLEMENT POPULATION

You can check on the population of a settlement at any time. Query any settlement and you'll see the level of technology from a fist (very primitive) to a sword (very advanced), and a population count in the form of eight flags moving up and down flagpoles around the back of the colosseum. It appears in decimal order:

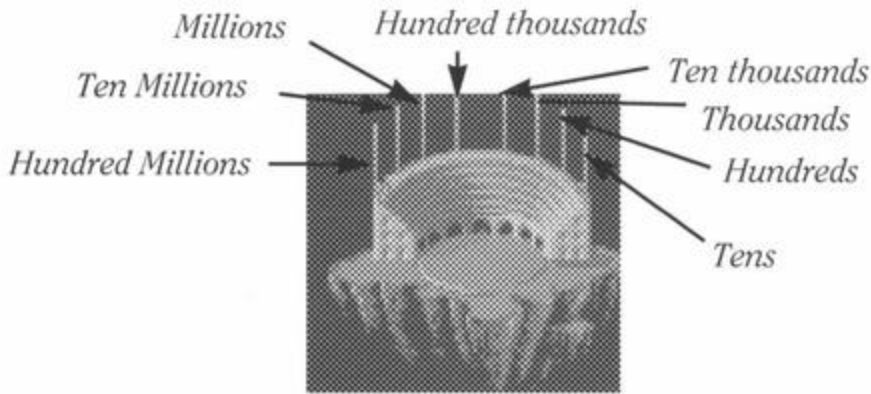

*To check the population of a settlement:*



1. Left-click on the Query icon
2. Move your cursor to a settlement on the close-up map
3. Left-click on the dwelling to attach the query icon to it. The settlement appears in the centre of the colosseum and a question mark appears on top of the dwelling.

*Level of Technology*

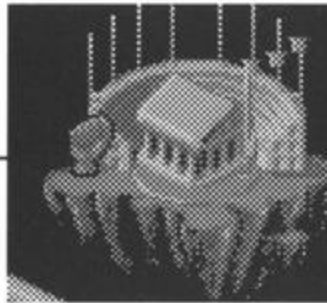

In the middle of the colosseum, you'll see a picture of the settlement. The flags on the colosseum flagpoles reflect the amount of the population.

If you sprog a walker from a queried settlement, the first walker out of the settlement takes the query mark with them.

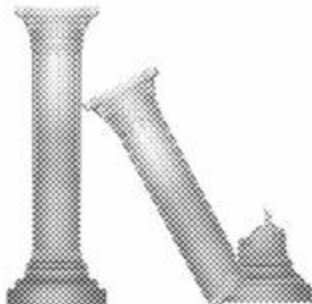

## **WALKER POPULATION**

Walkers represent a certain number of people in a tribe. When you query a walker, he or she appears in motion in the middle of the colosseum. Their tribes total population is displayed on the eight flagpoles behind the colosseum (see Settlement Population above for an illustration of how to read the flagpoles). When a queried walker settles, joins another walker, or another household the query is transferred to the new walker or dwelling.

The Level of Technology of a walker appears in the form of weapons in the lower left corner of the colosseum. A fist indicates the lowest form of technology, a sword the highest.

### *To check a walkers population:*



1. Left-click on the Query icon
  2. Move your cursor to the person or settlement you want to query
  3. Left-click again
- A question mark appears on top of a queried walker

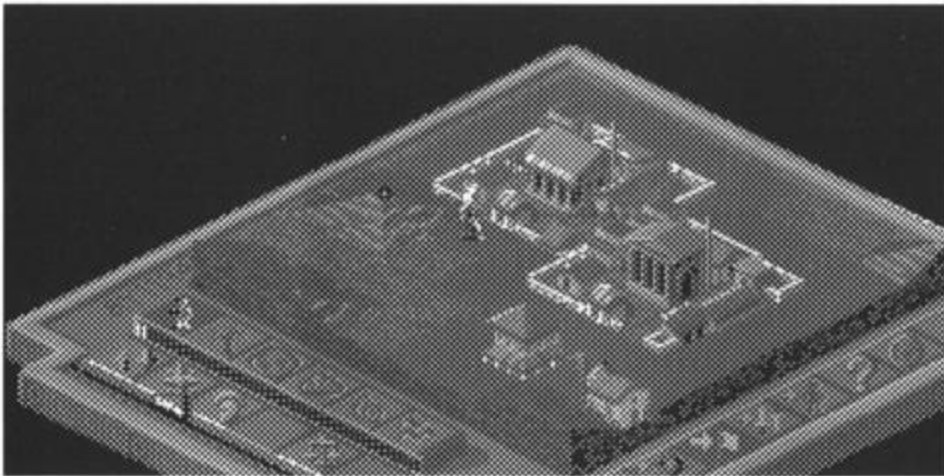

## **CLOSE-UP MAP**

The close-up map is where you carry out all divine commands and effects. View settlements, watch battles, lay waste to enemy land, build your land.

The close-up map reflects the section of land that is covered by the black cursor on the world map.



You can move around the Close-Up Map several ways.

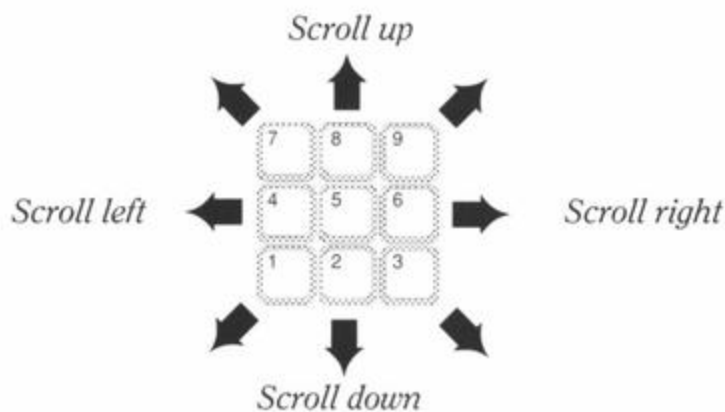
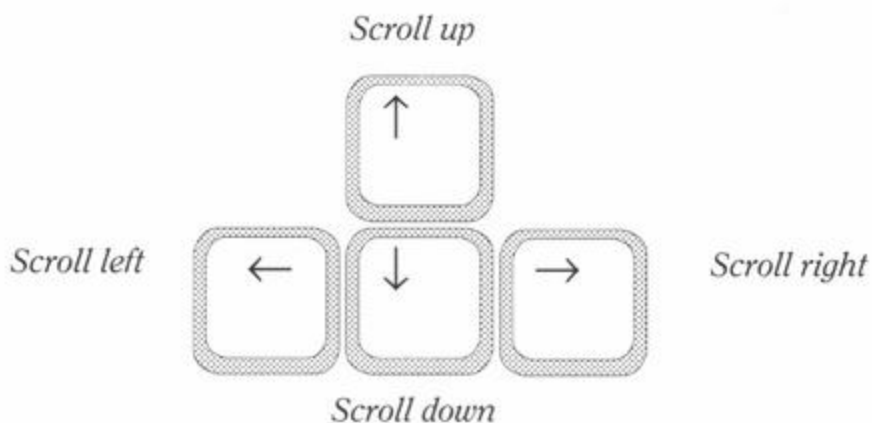

*Use the cursor keys or the number pad:*

*You can also use the brown directional arrows around the edge of the World Map:*

1. Move your cursor to a directional arrow
2. Left-click to move one increment in that direction

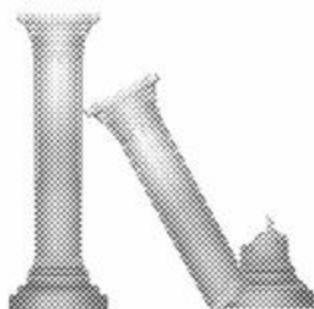



## WORLD MAP

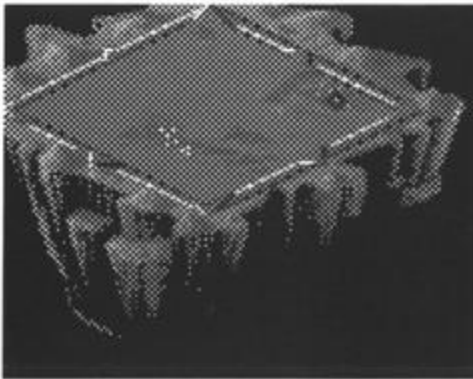

The world map shows the landscape of the world you're currently on.

- Blinking white dots are Good settlements
- Blinking yellow dots are Bad settlements
- Blue dots are Good walkers (your followers)
- Red dots are Bad walkers (followers of the Bad god)
- The small black diamond is the section of the world that is currently on the Close-Up Map
- Grey dots are plagued houses

### *To move around the World Map:*

Put your cursor on the place you'd like to go, then:

- Right-click to jump directly to that point
- Left-click to move towards that point one section. Keep clicking to move further

To scroll around the World map, hold down the right mouse button and move the mouse any direction on the map.

## RAISING AND LOWERING LAND

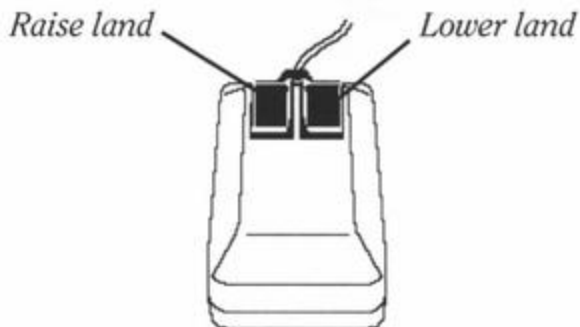

Flattening out farm land is vital for your population to spread out and grow. Raise land from the ocean's waters to extend peninsulas or flatten mountains into rich soiled acreage. To raise land out of the water, just move your cursor out into the body of water and left-click.

During a Custom game, you can define special rules about raising and lowering land for your Custom game.

*To lower land:*

1. Choose the Raise/Lower icon from the Influence Behaviour bar
2. Move the main point of the cursor (the black diamond) to the tip of a pyramid of land on the close up map
3. Press the right mouse button to lower it

*To raise land:*

1. Choose the Raise/Lower icon from the Influence Behaviour bar
2. Move the main point of the cursor (the black diamond) to the low point you'd like to raise on the close up map
3. Press the left mouse button to raise it

## SETTLEMENTS AND SPROGGING

Creating many big settlements is vital to the growth of your population and your power. Initially your settlements are small tents and huts, so spread out flat farmland around them to transform them into powerful castles. New settlements automatically occur as old ones fill up and walkers move out in search of more farmland to build on.

Sprogging is the most important technique to practice for spreading your population. Command well-populated settlements to release a walker to create new settlements and build the population. Well-populated settlements are recognisable by their high-flying flags: the further a flag is up the flagpole, the higher the number of people at that dwelling.



*To sprog a walker from a dwelling:*

1. Move the main point of your cursor to the centre point of a dwelling
2. Right-click

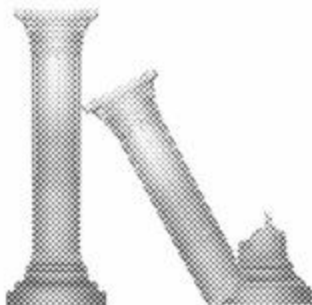

## MANA

Mana is the substance from which you draw power. You earn mana from your populations divine offerings, so increase your population as quickly as you can by sprogging dwellings to create new worshippers and dwellings. In order to use higher-level Divine Intervention Effects, you must have enough mana, but keep in mind that when you perform an effect, you use mana up. Different effects cost different amounts, so use your mana gauge to budget your power.

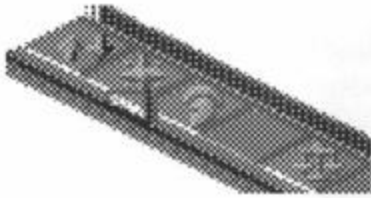

## MANA GAUGE

The mana gauge increases every time you earn mana. Likewise, it decreases every time you use mana to perform a Divine Intervention Effect.

The red line just below the Divine Intervention effects displays your total mana. The pointer just next to that shows what effects you have enough mana to perform (you can do all effects at the pointer and below).

## PAPAL MAGNETS

The papal magnets are icons of worship for Good and Bad. You can move your magnet to Bad territory, then influence your worshippers to go to it and invade Bad settlements. The first of your walkers to encounter your magnet becomes your leader. Convert strong leaders into special walkers called Heroes with your papal magnet. You can't place your papal magnet unless you have a leader.

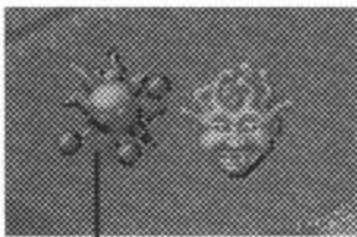

*Good papal magnet*



*Bad papal magnet*



## INFLUENCING BEHAVIOUR

Manipulate your way to victory by influencing your populations behaviour with the Influence Behaviour Commands. These commands are always available whether you're strong or weak. For information about how to use these commands, see *Influencing Behaviour Commands* under COMMANDS.

## WORSHIPPERS AND WALKERS

Worshippers is a term for your entire population. Walkers are the members of your population walking across the land. All worshippers have a level of intelligence according to the level of technology of the dwelling they emerge from.

### SPECIAL WALKERS

Some walkers have special attributes.

#### **LEADERS**

Both Good and Bad populations can have a leader of people, recognisable by the miniature papal magnets above their heads. When you select the Go To Papal Magnet icon, your people will first go to their leader, then follow them to the papal magnet. Leaders are the only members of your population you can transform into Heroes, and when you do, you'll need to create a new one by selecting Go To Papal Magnet.

#### **HEROES**

There are six heroes, one from each category of effects. When you have enough mana, turn your leader into a hero for greater destruction. Heroes tend to be immune to the effects of powers from within their own category.



## SOUNDS

Sounds are an important part of Populous II. If you hear the sound of fire burning, an earthquake, or other disaster, check your territory — somewhere your opponent has just done some creative landscaping to your settlements.

### HEARTBEAT

Throughout the game, you'll hear a steady heartbeat — your heartbeat. The slower it pounds the more healthy you are.



## DINGS

You'll hear a few metallic dings during play of Populous II which mean several different things: possibly a hero has been created or a papal magnet has been moved. Pay attention to events and sounds to be able to identify which sound means what.

## EFFECTS

You'll hear the sounds of many different Divine Intervention effects. The effects you cause are only audible when they are showing on the close-up map, but any effects used by your opponent on your land are audible as they happen.

## QUITTING A WORLD

*To quit a world:*



1. Left-click on the Game Requester icon
2. Select SAVE GAME to save the game, or QUIT MAP to quit the world. For more information about saving a game see your Command Summary Card





# COMMANDS

## BASIC COMMANDS

The Basic Commands let you influence the general behaviour of your followers, get information on populations and settlements, and bring up the Game Requester:

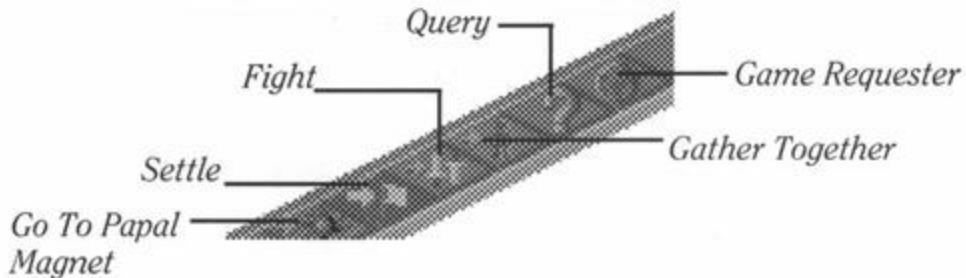

To use one of these commands, left-click on its icon.

### GO TO PAPAL MAGNET

Place your papal magnet in a strategic area then influence your people to walk to it. If you don't have a leader, use this command to get a walker there faster (he'll turn into your leader as soon as he touches the magnet). Remember, you can't place your papal magnet if you don't have a leader.

### SETTLE

Influence your people to build and settle on the land you flatten for them.

### GATHER TOGETHER

When two walkers randomly run into each other, they become one stronger walker, but influence your walkers to come together into fewer, stronger walkers with this Gather Together command. Your walkers tend to settle during this behaviour, so you'll be building strong settlements as well as people.



### FIGHT

Influence your walkers to walk toward Bad settlements and fight for your cause. Your walkers also settle and produce fighters while influenced to fight.



## QUERY COMMAND

Left-click on the query command for information about various people and settlements.

### *To get information:*

1. Left-click on the Query icon
2. Move your cursor to a target dwelling or walker on the close-up map
3. Left-click again to attach the query mark to them

Any dwelling or walker with the query mark on them appears in the centre of the colosseum. Only one dwelling or walker can be queried at a time. The colosseum reflects the population and technological intelligence of the walker or dwelling. For more information, see The Colosseum under CONQUERING WORLDS.

## GAME REQUESTER COMMAND

Left-click on the world icon to bring up the Game Requester:



The Game Requester lets you save and load games, quit or restart the world, and set various game options.

There are two kinds of buttons: green and gold. The green buttons let you choose between two different things or bring up a different requester. The gold buttons let you turn an option on or off. When the gold button is pressed in, the option is on; when the button is out, the option is off.

There are also ticks (✓) and X's next to some options. A tick means the option is active, the X means it's inactive.



### ***I AM GOOD/BAD***

You're a Good god by default. In Custom Games, however, you have the option of being an Bad god. Left-click on this option to change your morality from Good to Bad or vice versa.

### ***COMPUTER ASSIST ON/OFF***

When this option is Off, you have to raise and lower land and sprog settlements yourself. When On, the computer takes over some of these tasks so you can concentrate on destroying the enemy.

### ***COMPUTER V HUMAN/COMPUTER***

In Computer V Human mode, you play against the computer. In Computer V Computer mode, you can watch the computer play both sides, then join in when you like.

### ***LOAD GAME***

The Load Game option lets you load previously saved games. For detailed loading instructions, see Loading Saved Games on your Command Summary Card.

### ***SAVE GAME***

The Save Game option lets you save games to disk. For precise saving instructions, see Saving Games on your Command Summary Card.

### ***RESTART MAP***

The Restart Map option lets you restart your conquest of the current world.

### ***QUIT MAP***

The Quit Map option lets you quit the current world and return to the Game Menu.

### ***CONQUEST GAME***

A tick (✓) means that you're currently playing a Conquest Game — an ✗ means that you're not.

### ***CUSTOM GAME***

A tick (✓) means that you're currently playing a Custom Game — an ✗ means that you're not.



## **SERIAL GAME**

The Serial Game option lets you establish a data link between computers connected via modem or serial cable. For more details, see *Playing By Serial Link*.

## **PAINT MAP**

The Paint Map option lets you change the features on a Custom Game map. This option can only be selected for Custom Games. Left-click on the gold button to activate the Paint Map feature, and then click OK. When you return to the map, the Paint Map options appear in the upper right corner:



### **PAINT MAP OPTIONS**

**Blue Man** — To add Good walkers to the landscape, left-click on the Blue Man button, move the mouse to map, and click the left mouse button for each walker you want to put down.

**Red Man** — To add Bad walkers to the landscape, left-click on the Red Man button, move the mouse to map, and click the left mouse button for each walker you want to put down.

**Tree** — To add trees to the landscape, left-click on the Tree button, move the mouse to map, and click the left mouse button for each tree you want to put down.

**Rock** — To add rocks to the landscape, left-click on the Rock button, move the mouse to map, and click the left mouse button for each rock you want to put down.

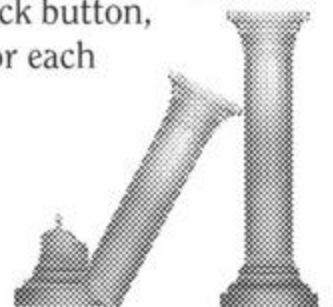

**My Mana** — To raise your mana, left-click on the Up Arrow (↑). To lower your mana, left-click on the Down Arrow (↓).

**His Mana** — To raise your opponent's mana, left-click on the Up Arrow (↑). To lower his mana, left-click on the Down Arrow (↓).

**Landscape** — Left-click on the Up Arrow (↑) to scroll through the different landscapes: Fertile, Snow, Desert and Sludge.

**New Map** — Left-click on the New Map button to select a different map to conquer.

## GAME OPTIONS

Left-click on the Game Options button to bring up the Game Options requester:

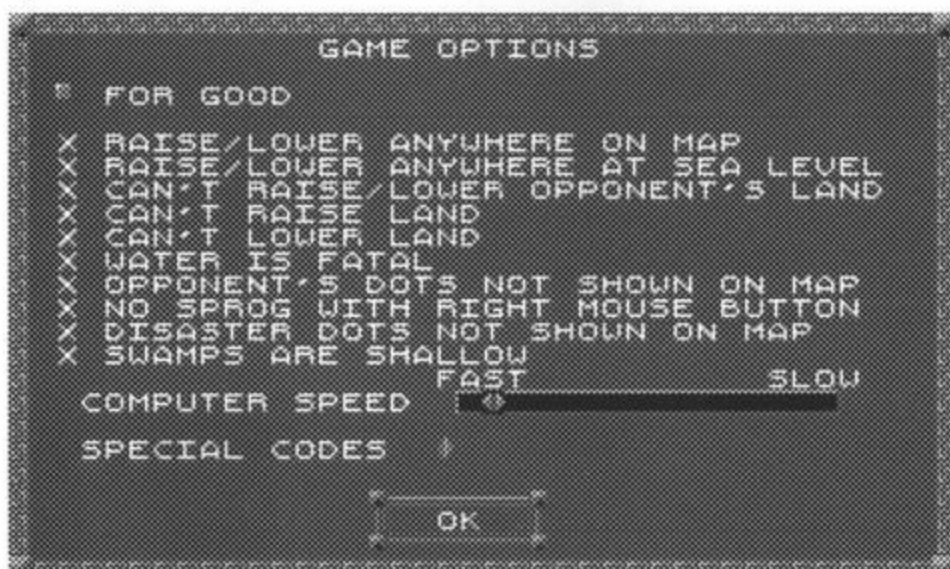

The Game Options let you determine how certain features on the landscape work. *You can only adjust these options for a Custom Game.* Any changes you make to the settings affect only the side currently displayed (For Good or For Bad).

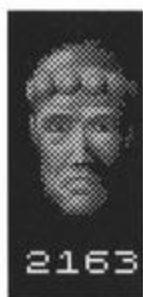

Left-click on the green button to choose whether you're setting the game options for Good or for Bad, and then left-click on the ticks (✓) and ✕'s to turn the option on or off.

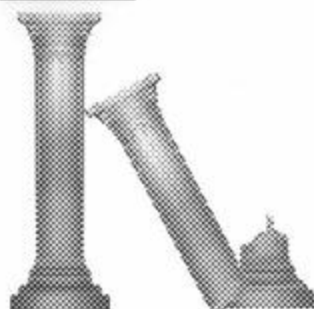



## *GAME OPTIONS*

### ***FOR GOOD/BAD***

Lets you choose which side (Good or Bad) you're currently setting options for.

### ***RAISE/LOWER ANYWHERE ON MAP***

- ✓ You can raise and lower land regardless of whether a settlement is in view on the Close-Up Map.
- ✗ You can only raise and lower land when a settlement is in view on the Close-Up Map.

### ***RAISE/LOWER ANYWHERE AT SEA LEVEL***

- ✓ You can only raise and lower land at sea level.
- ✗ You can not raise and lower land at sea level.

### ***CAN'T RAISE/LOWER OPPONENT'S LAND***

- ✓ You cannot raise or lower his opponent's land.
- ✗ You can raise and lower his opponent's land.

### ***CAN'T RAISE LAND***

- ✓ You cannot raise land.
- ✗ You can raise land.

### ***CAN'T LOWER LAND***

- ✓ You cannot lower land.
- ✗ You can lower land.

### ***WATER IS FATAL***

- ✓ Your people automatically drown in water.
- ✗ Your people can be saved if they're dropped in water.

### ***OPPONENT'S DOTS NOT SHOWN ON MAP***

- ✓ You cannot see opponents on the World Map.
- ✗ You can see opponents on the World Map.

### ***NO SPROG WITH RIGHT MOUSE BUTTON***

- ✓ Right-clicking lowers land no matter where the cursor is on the map.
- ✗ Right-clicking on the centre of a dwelling sprogs a walker.

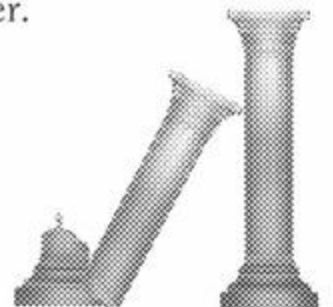

### ***DISASTER DOTS NOT SHOWN ON MAP***

- ✓ You cannot see disaster effects on the World Map.
- ✗ You can see disaster effects on the World Map.

### ***SWAMPS ARE SHALLOW***

- ✓ When a person falls in a swamp, the swamp is “filled” and disappears.
- ✗ No matter how many people fall in a swamp, it will never be filled.

### ***COMPUTER SPEED***

If you have a computer with an advanced processor, you might want to slow down its reactions to make the game more fair. Left-click anywhere on the black bar to move the setting.

### ***SPECIAL CODES***

Many special codes to enter in this slot will be released in forthcoming publications, but we'll start you off with one. Left-click in the slot, then type MUSIC, and play Populous II to deluxe mood music.

### ***ABOUT***

Who designed, created, conceived and programmed Populous II? That's right, those sexy guys at Bullfrog Productions, Ltd. Left-click on this option for more information.

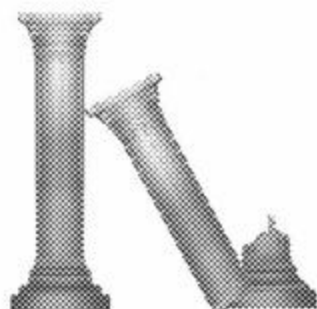

## DIVINE INTERVENTION COMMANDS

30 Divine Intervention Effects are your weapons against your opponent and your only means for helping your population. Effects use up your mana; great effects like tidal waves and earthquakes are expensive. A lesser effect like lowering and raising land costs little. You can strengthen any effect by applying earned experience points to its category at the Deity Creation screen.



### PEOPLE EFFECTS

These commands allow you to effect your population.

#### **RAISE/LOWER LAND**



Flattening out farm land is vital for your population to spread out and grow. Raise land from the ocean's waters to extend peninsulas or flatten mountains into rich soiled acreage. To raise land out of the water, just move your cursor out into the body of water and left-click.

##### *To lower land:*

1. Choose the Raise/Lower icon from the Basic commands bar
2. Move the main point (the black diamond) of your cursor to the tip of a pyramid of land on the close up map
3. Right-click to lower it

##### *To raise land:*

1. Choose the Raise/Lower icon from the Basic commands bar
2. Move the main point of the cursor to the low point you'd like to raise on the close up map
3. Left-click to raise it

#### **PLACE PAPAL MAGNET**



YOU MUST HAVE A LEADER BEFORE YOU CAN PLACE THE PAPAL MAGNET. Clicking on this icon lets you place your papal magnet. Putting it in the right place at the right time offers great strategic advantage. Place it protectively inside castle walls and influence your walkers to gather there, combining for strength. Place it deep in the heart of enemy territory and influence your walkers to walk to it; they'll destroy all that comes in their path of their holy pilgrimage.

The first walker to arrive at the papal magnet is your leader. When your leader is at the magnet, he is surrounded by a blue flame of holy fire and is invincible.



*To place the papal magnet:*

1. Left-click on the Place Papal Magnet icon
2. Move your cursor to the point on the close-up map you'd like to place the magnet
3. Left-click

Right-click on the Place Papal Magnet icon to jump directly to the current papal magnet location on the close-up map.

**PERSEUS**



Change your leader into the hero Perseus by clicking on this icon. Perseus is the most intelligent of the greek heroes, and makes a strong and skillful soldier driven to destroy Bad settlements. Turn as many leaders as you want into Perseus, but remember that each time you turn your leader into a hero, you'll need to establish a new leader by selecting the Go To Papal Magnet command.

*To turn your leader into the hero Perseus, left-click on the Perseus icon.*

**LAY PLAGUE**



Lay plague on an enemy walker or settlement. When a walker has the plague, they'll spread the illness to all dwellings and people they touch. Plagues can only be stopped by destroying the infected dwellings and people. Plague victims don't give you any mana, and if Armageddon is declared, they instantly disintegrate leaving only your healthy population to fight for your cause.



Identify a plagued person or house by the vulture circling in the air above the infected person or dwelling. If you hear the tell-tale "caw-caw" of the plague vulture and you don't see one onscreen, check your settlements. Your enemy has infected your population.

*To lay plague:*

1. Left-click on the plague icon
2. Move your cursor to the dwelling or person you want to infect
3. Left-click

Repeat all steps for each new dwelling or worshipper you want to plague (be careful though, plague spreads fast!)



## **DECLARE ARMAGEDDON**



When you have enough mana and your population is larger and stronger than your opponent's, declare Armageddon to get the forces of Good and Bad to march to the centre of the world and fight to the death.

*To declare Armageddon, left-click on the Armageddon icon.*



## **VEGETATION**

Control the vegetation of the world with the Vegetation effects.

### **GROW FOREST**



Earn popularity points by planting trees around your settlements.

*To plant trees:*

1. Left-click on this icon
2. Move your cursor to an area on the close-up map
3. Left-click again to plant the trees

### **RENEW LAND**



Renew damaged land with greenery and flowers. After a volcano, planting greenery is the only way to make the land livable again for your people. People are happy on a beautiful landscape, so increase your popularity points by planting this greenery around your settlements. This greenery spreads if planted in the right patterns, so cluster plantings together and give them plenty of room to spread.

*To plant:*

1. Left-click on the Greenery icon
2. Move your cursor to an area on the close-up map
3. Left-click again to plant

### **SWAMP**



Lay a swamp on enemy land to swallow Bad walkers.

*To swamp enemy land:*

1. Left-click on the Swamp icon
2. Move your cursor to an area on the close-up map
3. Left-click again to lay the swamp.

For a bigger swamp, repeat all steps a few times in one area





## **PLANT FUNGUS**

 Plant deadly fungus around enemy settlements and watch it spread to cover their territory. For the most damaging spread and growth pattern, plant fungus in straight rows of three or five, but be careful with it. If it creeps into your territory, it could finish off your settlements as well.

### *To plant fungus:*

1. Left-click on the Fungus icon
2. Move your cursor to an area on the close-up map
3. Left-click on the pieces of land where you want it planted

## **ADONIS**

 Turn your leader into Adonis, the hero of vegetation recognisable by his head of leaves. He divides after combat, multiplying your number of hero's roaming the world for your cause. Turn as many leaders as you want into Adonis, but remember that each time you turn your leader into a hero, you'll need to establish a new leader by selecting the Go To Papal Magnet command.

*To turn your leader into Adonis, left-click on the Adonis icon.*

## **EARTH**

Earth effects give you control of earthly disasters and benefits.

## **ROADS**

 Build roads on flat ground and low slopes for your people to walk on and make their travel faster, or use them to block the spread of fungus. Roads are laid down one square at a time.

### *To build a road:*

1. Left-click on the Roads icon
2. Move your cursor to the area you want to begin building on the close-up map
3. Left-click and move the mouse in a row to lay down the squares of a road, right-click to remove a square.

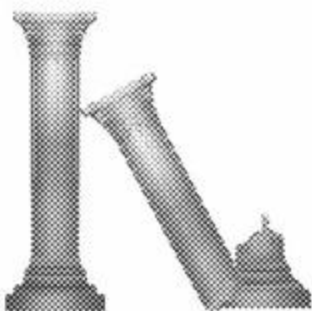

## **CITY WALLS**



Build city walls on flat land around your settlements to protect your worshippers. Neither you or your opponent can alter the land a city wall is built on. You can't build on enemy land

After you build your first city wall, all other city walls must be connected to it. For example, if you build a city wall around one settlement, the next piece of wall you lay down must stem from the original wall and extend out to the next settlement you want to surround. The only way to have two separate walled settlements is if your opponent somehow destroys the connector wall between the two.

Weak enemies are kept out by city walls, but strong enemies can climb over. If a very strong enemy walker encounters a wall, they could break through it, so don't leave walled settlements unwatched.

### *To build a city wall:*

1. Left-click on the City Walls icon
2. Move your cursor next to the settlement you want to surround on the close-up map
3. Left-click in a circle around the settlement to lay the wall

## **EARTHQUAKE**



Cause a rumbling earthquake to split enemy territory wide open and leave behind a rift that swallows your opponent's population. Earthquakes are special in that you can aim them in a general direction with the pointer that orbits your cursor.

### *To cause an earthquake:*

1. Left-click on the earthquake icon. A pointer slowly orbits your cursor
2. Move your cursor to the close-up map next to where you want to start the earthquake
3. When the pointer is aiming the right direction, left-click again



## **BATHOLITH**



A batholith is an underground movement of rock which causes the land to rise, and forces numerous boulders through the surface. Create a batholith on enemy territory to destroy their farmland.

### *To lay a batholith:*

1. Left-click on the Batholith icon
2. Move your cursor to an area on the close-up map
3. Left-click and hold to cause the batholith. Hold down the mouse button for larger batholiths

## **HERACLES**



Turn your leader in to the hero Heracles to double his strength and send him crusading into enemy territory. Turn as many leaders as you want into Heracles, but remember that each time you turn your leader into a hero, you'll need to establish a new leader by selecting the Go To Papal Magnet command.

*To turn your leader into Heracles, left-click on the Heracles icon.*



## **A<sup>IR</sup>**

Weapons such as rain, lightning, and gale force winds are at your command when you select elements from the Air category.

## **LIGHTNING**



Electrocute enemy walkers and destroy enemy settlements and farmland by striking with lightning bolts. You won't be able to aim the lightning bolts exactly, so just strike on or near the target area.

### *To strike with lightning:*

1. Left-click on the lightning icon
2. Move your cursor to an area on the close-up map. Notice the storm cloud following your cursor — it's waiting for your command to strike
3. Left-click and hold to strike. The longer you hold down the mouse button, the more damage done

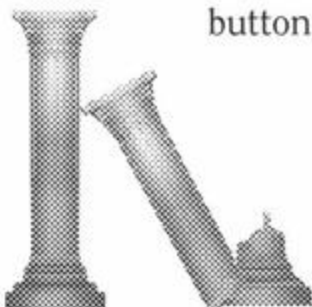

## **WHIRLWIND**



Start a whirlwind spinning through enemy settlements for maximum devastation. When a whirlwind goes off land, it creates a land-eating whirlpool in the water. If an armed worshipper gets sucked up by a whirlwind, all his weapons are flung out of his hands, and he is reduced to low intelligence. Anyone sucked into a whirlwind gets flung to the ground when the wind stops.

### *To create a whirlwind:*

1. Left-click on the Whirlwind icon
2. Move your cursor to a target on the close-up map
3. Left-click again to start the whirlwind.

For each new whirlwind, repeat all steps

## **STORM**



Create a rainstorm over enemy territory and destroy your opponent's land with lightning and heavy rain. There is no way to stop a storm.

### *To create a storm:*

1. Left-click on the Storm icon
2. Move your cursor to an area on the close-up map
3. Left-click again to start a storm

## **HURRICANE WIND**



Cause a gale-force wind to sweep the landscape and devastate enemy land.

### *To call a hurricane:*

1. Left-click on the Hurricane Wind icon. A pointer orbits your cursor.
2. Move your cursor to an area on the close-up map
3. When the orbiting pointer is facing the direction you want the gale to blow, left-click

## **ODYSSEUS**



Change your leader into Odysseus, fastest of the heroes, and send him crusading into enemy territory. Turn as many leaders as you want into Odysseus, but remember that each time you turn your leader into a hero, you'll need to establish a new leader by selecting the Go To Papal Magnet command.

*To turn your leader into Odysseus,* left-click on the Odysseus icon.





## FIRE

The fire elements are doubly potent because they burn up enemy settlements and worshippers, and ruin all farmland they come in contact with.

### ***FIRE COLUMN***



Start a towering column of flame randomly burning across an area with this effect. Fire columns tend to move uphill and hover around the top, so they damage more land when lit on flat ground.

*To light a column of fire:*

1. Left-click on the Column of Fire icon
2. Move your cursor to an area on the close-up map
3. Left-click again.

Repeat all steps for each new column

### ***RAIN OF FIRE***



Start a devastating rain of fire over enemy territory.

*To start a rain of fire:*

1. Left-click on the Fire Rain icon
2. Move your cursor to an area on the close-up map
3. Left-click again

### ***VOLCANO***



Erupt a volcano on enemy land and send lava flowing out to the sea to become a basalt peninsula in the water. Land beneath the volcano is almost permanently destroyed. The size of the volcano you cause depends on your experience points invested in Earth effects at the Deity Creation screen.

If a volcano erupts on your land, cap it as soon as you can by building land on top of it, then flatten it out. The only way to make the land usable again is by planting Greenery on the damaged area. Protect your settlements from burning lava with a low hill.

*To cause a volcano:*

1. Left-click on the volcano icon
2. Move to an area on the close-up map
3. Left-click again

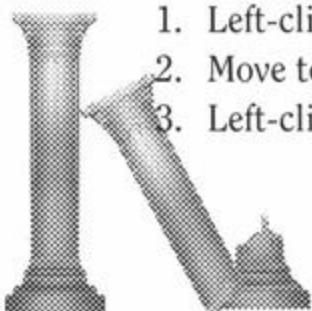



## **ACHILLES**



Turn your leader into Achilles, a fast runner with a head of flames who burns everything in his path. Turn as many leaders as you want into Achilles, but remember that each time you turn your leader into a hero, you'll need to establish a new leader by selecting the Go To Papal Magnet command.

*To turn your leader into Achilles, left-click on the Achilles icon.*



## **W**<sup>A</sup>TER

Create tidal waves, whirlpools and baptismal fonts with the effects in this category.

## **BASALT**



Create bridges of basalt across water by causing minor volcanic activity with this effect. Arrest enemy land expansion by laying basalt in the water around enemy coastline.

*To create a bridge of basalt:*

1. Left-click on the Basalt icon. An orbiting pointer rotates around your cursor
2. Move your cursor to where you want the starting point of the basalt bridge
3. When the orbiting pointer points the direction you'd like the bridge to lay, left click again

## **WHIRLPOOL**



Lay land-eating whirlpools in the water off the coast of enemy territory. Whirlpools multiply quickly and there's no way to stop them, so plant them far away from your land.

*To cause a whirlpool:*

1. Left-click on this icon
2. Move to the target on the close-up map
3. Left-click again to start the whirlpool



## **BAPTISMAL FONTS**



Baptismal fonts create pools of holy water in the ground. When a walker falls into one, he or she changes to the opposite faith (Good walkers turn Bad and Bad walkers turn Good). Create fonts on enemy territory to create walkers faithful to your cause in the heart of your opponent's settlements.

This effect is tricky because occasionally two fonts appear next to each other, and when a walker falls in and changes, he'll immediately fall into the adjacent font and return to his original loyalties.

### *To create Baptismal Fonts:*

1. Left-click on the Baptismal Fonts icon
2. Move your cursor to an area on the close-up map
3. Left-click again to create the fonts

## **TIDAL WAVE**



Set Tidal Waves far out in the oceans off your enemy's coastline to wreak watery devastation to his territory. A Tidal Wave effects the entire world, so settle your people on high land before you start one. If your enemy lays a Tidal Wave, rise a high wall of land around your coastline to keep water out.

### *To cause a Tidal Wave:*

1. Left-click on the Tidal Wave icon
2. Move your cursor into the oceans far off enemy coastline on the close-up map. The further out you begin the tidal wave, the more momentum it can build up on its way inland

## **HELEN OF TROY**



Turn your leader into Helen of Troy, a woman of legendary beauty and grace who has lead many a men to their doom. She marches into enemy territory and leads your opponent's worshippers to a watery grave in the seas. Turn as many leaders as you want into Helen of Troy, but remember that each time you transform a leader, you'll need to establish a new one by selecting the Go To Papal Magnet command.

If your enemy creates Helen, try destroying her with fire or lightning. She's very wise and can sense when you're targeting her, so she'll attempt to escape your gaze by switching directions often, so be prepared to act fast when you see her on the close-up map.

*To turn your leader into Helen of Troy, left-click on the Helen of Troy icon.*

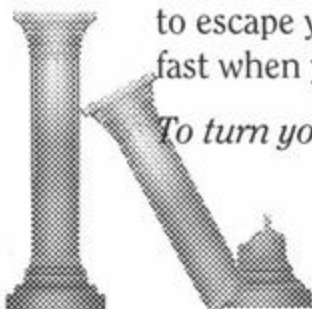

# WINNING

There are several different ways to win Populous II. You can win worlds, win experience points (even if you lose a world), or you can reach the ultimate goal, defeating Zeus.

## EARNING EXPERIENCE POINTS



As you earn experience points, apply them to one of the six categories of effects at the Deity Creation screen. As you invest experience points in a category (population, fire, water, etc.) the power of any effect you use from that category increases. For example, say you earn five lightning bolts of experience after a battle and apply them all to the fire category. The next time you use any effect from the fire category, it's stronger. Fire columns last longer as do Rains of fire, Achilles is stronger and faster, and your Volcanoes are much more damaging and permanent.

To apply a lightning bolt of experience to a category, left-click once on a category icon.

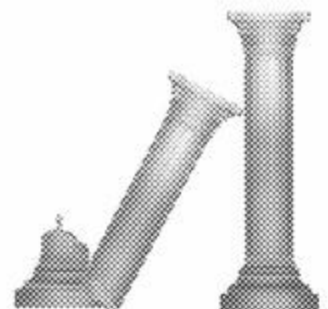

## GAME SUMMARY SCREEN



At the end of every world, you'll be seated across the table from your opponent god and given lightning bolts of experience for your battle. On the table between the two of you, watch a replay of the battle. Your opponent deity gives you lightning bolts as a reward for your strategy and speed, which you can exchange for experience at the Deity Creation screen.

## SAVING A GAME

See your Command Summary Card included in your package for information about how to save a game.

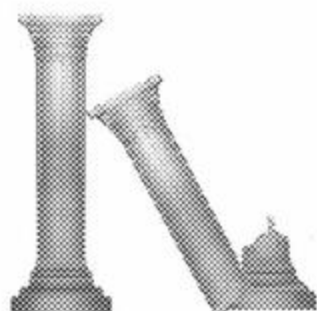

# STRATEGIES AND TECHNIQUES

## **SPROG FOR POPULATION**

Right-click on the very centre of a dwelling to get walkers to leave and settle. This is the most effective way for you to increase your mana quickly.

## **SINK ROCKS**

Lower the land around any rock to the water and the rock sinks forever. Build new, healthy farmland over the area where the rock once was.

## **REPAIR DAMAGED LAND**

To repair fire or quake-damaged land, lower or raise it, then flatten it again. The land instantly becomes farmland once again.

## **LAY FONTS AROUND ENEMY PAPAL MAGNET**

When your enemy's worshippers are walking to their papal magnet, lay baptismal fonts around it. The ensuing fight is a vision to behold.

## **LEAD YOUR ENEMIES INTO A SWAMP**

Create roads across enemy territory. Bad worshippers will tend to walk on the roads, so create a swamp at the end of one. Watch bad worshippers drown in the mud.

## **LAY WHIRLPOOLS IN ENEMY TERRITORY**

Lower land into the water until you create a lake in the middle of enemy territory, then plant whirlpools in the lake. The whirlpools are indestructible and eat away at the enemy's land.

## **CREATE HILLS AGAINST TIDAL WAVES**

Build populations on high land or build a wall of land around your coastline before you cause a tidal wave. If you don't, you're likely to wipe out a large chunk of your population.

## **CREATE HILLS AGAINST LAVA**

Lava always flows in a straight line, so if some is heading toward your settlements, raise a section of land in front of the flow to stop it.



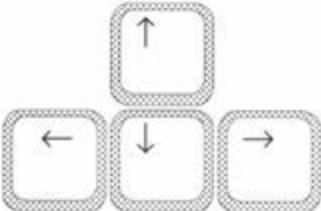

# KEYBOARD EQUIVALENTS

|                    |   |
|--------------------|---|
| Pause              | <b>F10</b>  |
| Zoom in            | - (Minus) key on keypad   |
| Zoom Out           | + (Plus) key on keypad  |
| Full Screen        | <b>Enter</b> on keypad  |
| People Effects     | <b>F1</b> key   |
| Vegetation Effects | <b>F2</b> key   |
| Earth Effects      | <b>F3</b> key   |
| Air Effects        | <b>F4</b> key   |
| Fire Effects       | <b>F5</b> key   |
| Water Effects      | <b>F6</b> key   |
| Take a Snapshot    | <b>F7</b> key   |
| Scroll Up          |  |
| Scroll Down        |   |
| Scroll Right       |   |
| Scroll Left        |   |

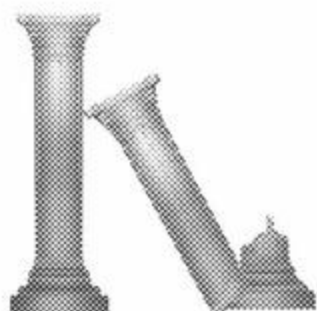

# PLAYING BY SERIAL LINK

There are two ways to play Populous II against a human opponent: using a modem to connect to a remote player, or by using a null modem cable to connect the serial ports of two computers (this is *datalink* mode).

To play a serial game, both players need original copies of Populous II.

## FIRST THING

### ***TALK TO THE OTHER PLAYER!***

#### *Decide:*

- Who is going to play as the Good god, and who plays Bad.
- Who will send and who will receive (remember, the one who sends is paying the phone bill).
- Times for game pauses When one player pauses, the other gets automatically paused.

## CONNECTING IN DATALINK MODE

1. Get a null modem cable. You can probably find one in your local computer store.
2. Make sure power to both machines is OFF.
3. Connect the cable between the serial ports of the two computers.
4. Turn both machines ON.
5. Boot the game on both machines and start the game in Custom mode by left-clicking on CUSTOM at the Game Menu.
6. Next choose who is going to be the Good god and the Bad god.
7. Left-click on the Game Requester icon.
8. When the Game Requester screen appears, left-click on SERIAL GAME.
9. When the Link Requester screen appears, adjust your baud rate by left-clicking on the arrows on either side of the BAUD RATE number. Baud rates of the two modems **MUST** be the same.
10. Left-click on CONNECT.

You'll get a message box that tells you the modem's trying to connect and what number try it's on. It will stop as soon as you're connected.



## CONNECTING MODEMS

1. Ensure both the computer and your modem are turned off
2. Connect the modem's serial cable to the computer, then connect the modem to the phone line.
3. Turn on the modem and your computer.
4. Boot Populous II on both computers.
5. Both players must choose the same world: either choose Custom mode with the beginning five effects available, or choose Conquest mode and both type in the name of the world with the effects you want, and go back to Custom mode with those effects. Alternatively, you both could use an identical saved game.
6. Left-click on the Game Requester screen, then left-click good god or bad god, whichever you've agreed to with your opponent.
7. Left-click on the Serial Game option, then left-click on OK.
8. When the Link Requester screen appears, adjust your baud rate by left-clicking on the arrows on either side of the BAUD RATE number. Both players must have and select the same baud rate.
9. The Modem Message line on your Link Requester screen is where you can type commands to your modem.  
See your modem's manual for the exact commands your modem can receive. To send a command, left-click in the Modem Message line, type your command, then press RETURN. Your command appears on the line beneath. If you type a second command, you need to delete the old message first.
10. As a general guide to connecting, do the following:  
The dialling player should type ATD and the receiver's phone number (no spaces), then press RETURN.  
The receiving player, once he has heard his modem answer, should type ATA, followed by RETURN.
11. If you have successfully established a connection, both players should see a string of question marks (????) appear in the box below the Modem Message line. Both players should now left-click on CONNECT. Both machines will load the selected world and play can begin.

Note: There are many reasons why you may have difficulty in connecting with modems. If you are experiencing difficulty, try connecting to your friend's computer with a modem terminal package, or something similar before loading Populous II. Consult your modem manual for any commands you may need to know to configure your modem correctly.

## PAUSING THE GAME

If you pause the game with **F10** or by bringing up the Game Requester, your opponent gets paused too, so schedule pauses before you link up.



# CREDITS

## Designed by Bullfrog Productions, Ltd.

|                          |  |
|--------------------------|--|
| Level Design:            | Alex Trowers, Glenn Corpes, Sean Cooper, Kevin Donkin, and Bryan Hapgood   |
| Producer:                | Joss Ellis   |
| Assistant Producer:      | Kevin Shrapnell  |
| Programmers:             | Peter Molyneux, Glenn Corpes   |
| Product Management:      | Christopher Thompson   |
| Game Graphics:           | Gary Carr and Paul McLaughlin  |
| Technical Assistance:    | Jeff Haas, Colin McLaughlin  |
| Sounds:                  | Charles Callet, Les Edgar  |
| Music:                   | Charles Callet   |
| Cover Art:               | David Rowe   |
| Documentation:           | Andrea Smith & David Luoto   |
| Manual Layout:           | Carol Aggett and Chris Morgan  |
| Comics:                  | Fox  |
| Bullfrog Testing:        | Peter Carter, Johnathan Barnes, Chris Brereton, Kristian Wilson, Giles Cookson, James Richardson, Anton Rodgers, Mark Ayre, Alfie Noakes, Alex Trowers, Bryan Hapgood, Kevin Donkin, Glenn Corpes, Gary Carr, Paul McLaughlin, Scott Johnston, Sean Cooper |
| Electronic Arts Testing: | John Roberts, Jason Whitely, Stephen Holmes, Matthew Webster, Scott Probin   |



## **ZEUS SAYS: COPYING SOFTWARE IS UNGODLIKE.**

"None of my kids would participate in such a travesty of honesty." These immortal words were found etched in the stones that line the foothills of mount Olympus in Greece. They were a divine confirmation of what we mortals have known all along — that copying software illegally is only practiced by the lowest form of pond scum.

Many people — designers, artists, programmers — invested their time and talent to provide you with quality interactive entertainment. When you copy software without authorisation, you rob these people of their hard work and raise the cost to legitimate users. And if it needs to be repeated, copying this game for any reason other than making backup copies is against the law.

Electronic Arts is a member of the FAST (Federation against software theft) and supports the industry's effort to fight the illegal copying of personal computer software. Don't copy software illegally.

## **CUSTOMER SERVICE**

If you have any queries about this product, Electronic Arts' Customer Service Department can help. Call (0753) 546465 Monday to Friday between 9:00am and 6:00pm. Please have the product and the following information to hand when you call. This will help us answer your question in the shortest possible time:

- Type of computer you own
- Any additional system information (like type and make of monitor, printer, hard disk, etc.)
- Type of operating system
- Description of the problem you are having

If you live outside of Europe, you can contact one of our other offices.

- In the United States, contact Electronic Arts, P.O. Box 7578, San Mateo, CA 94403-7578. Tel. (415) 572-ARTS
- In Australia, contact Electronic Arts Pty. Ltd., P.O. Box 539, Ashmore City, QLD 4214 Tel: 008 074 298





# NOTICE

ELECTRONIC ARTS RESERVES THE RIGHT TO MAKE IMPROVEMENTS IN THIS PRODUCT DESCRIBED IN THIS MANUAL AT ANY TIME AND WITHOUT NOTICE.

THIS MANUAL, AND THE SOFTWARE DESCRIBED IN THIS MANUAL, IS UNDER COPYRIGHT. ALL RIGHTS ARE RESERVED. NO PART OF THIS MANUAL OR THE DESCRIBED SOFTWARE MAY BE COPIED, REPRODUCED, TRANSLATED OR REDUCED TO ANY ELECTRONIC MEDIUM OR MACHINE-READABLE FORM WITHOUT THE PRIOR WRITTEN CONSENT OF ELECTRONIC ARTS LIMITED, 11/49 STATION ROAD, LANGLEY, BERKS SL3 8YN, ENGLAND.

ELECTRONIC ARTS MAKES NO WARRANTIES, CONDITIONS OR REPRESENTATIONS EXPRESS OR IMPLIED, WITH RESPECT TO THIS MANUAL, ITS QUALITY, MERCHANTABILITY OR FITNESS FOR ANY PARTICULAR PURPOSE. THIS MANUAL IS PROVIDED "AS IS". ELECTRONIC ARTS MAKES CERTAIN LIMITED WARRANTIES WITH RESPECT TO THE SOFTWARE AND THE MEDIA FOR THE SOFTWARE. IN NO EVENT SHALL ELECTRONIC ARTS BE LIABLE FOR ANY SPECIAL, INDIRECT OR CONSEQUENTIAL DAMAGES.

THESE TERMS AND CONDITIONS DO NOT AFFECT OR PREJUDICE THE STATUTORY RIGHTS OF A PURCHASER IN ANY CASE WHERE A PURCHASER IS A CONSUMER ACQUIRING GOODS OTHERWISE THAN IN THE COURSE OF A BUSINESS.

Software © 1991 Bullfrog Productions, Ltd. All rights reserved.

Documentation © 1991 Electronic Arts. All rights reserved.

Populous is a registered trademark of Electronic Arts.

Populous® II: Trials of the Olympian Gods is a trademark of Electronic Arts

Amiga is a registered trademark of Commodore-Amiga, Inc.



## LOG YOUR PASSWORDS AND WORLD NAMES

A series of horizontal dotted lines for writing.

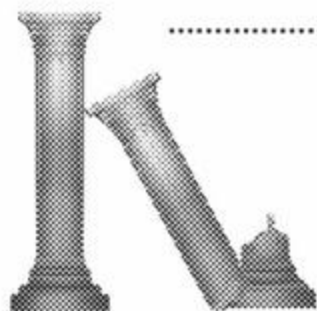

Dotted lines for handwriting practice.

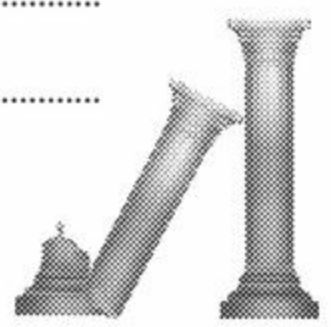







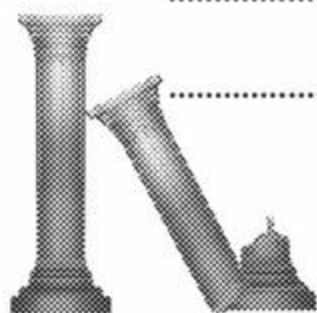
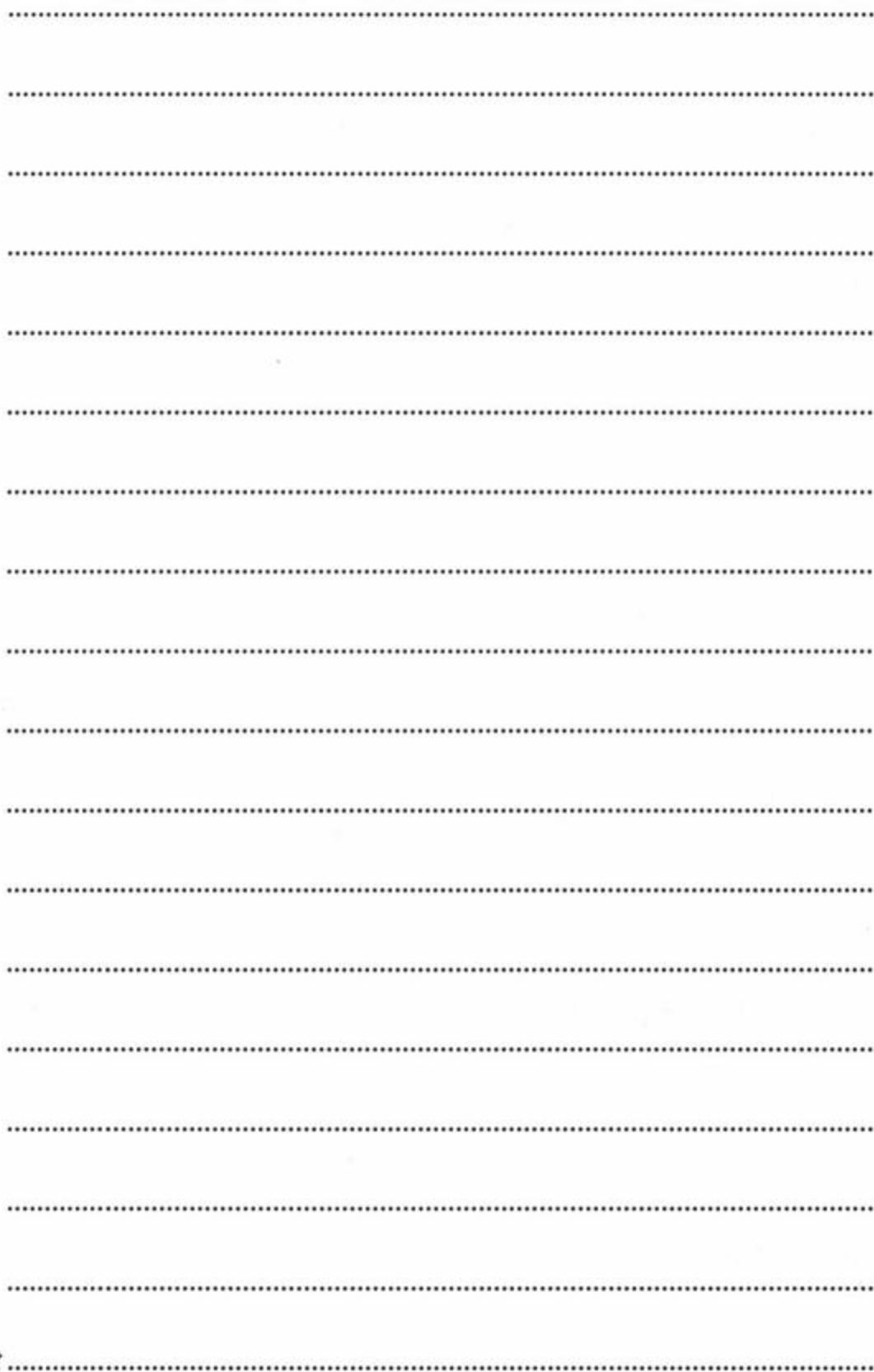





**ELECTRONIC ARTS®**

Langley Business Centre  
11-49 Station Road, Langley  
Berks, England SL3 8YN  
Tel: (0753) 549442

P.O. Box 7578, San Mateo  
CA 94403-7578  
USA  
Tel: (415) 572-ARTS

**E20500EM**