

# GUNSHIP™

# 2000



INSTRUCTION MANUAL



# GUNSHIP™ —2000—



**MICRO PROSE™**  
SIMULATION • SOFTWARE

**GUNSHIP 2000**  
Computer Simulation

MicroProse Software  
Unit 1 Hampton Road Industrial Estate, Tetbury, Gloucestershire GL8 8LD  
Tel: (0666) 504326

All Rights reserved  
Copyright © 1991 by MicroProse Software Inc.

This book may not be reproduced in whole or in part by any means without permission,  
with the exception of quoting brief passages for the purpose of review.

**Printing History**  
**First Printing 1991**  
**Printing: 9 8 7 6 5 4 3 2 1**

Gunship 2000 is MicroProse Software's trademark for its simulation of Helicopter Combat  
IBM is a registered trademark of International Business Machines, Inc.  
Apple and Macintosh are registered trademarks of Apple Computer, Inc.  
Tandy is a registered trademark of Tandy Corporation  
AdLib is a registered trademark of AdLib Incorporated  
Roland MT-32 is a registered trademark of RolandCorp, USA.

---

## CREDITS

### GAME DESIGN

James M. Day  
with Darrell Dennies  
& Detmar Peterke

### PROGRAMMING

Darrell Dennies  
Detmar Peterke

### TOPOGRAPHICAL 3-D CONCEPT/PROGRAMMING

Darrell Dennies

### ANIMATION TOOLS

David McKibbin

### ART CONCEPT/DESIGN

Michael Reis

### WORLD GRAPHICS

James M. Day

### 3-D GRAPHICS

Max Remington III

### ORIGINAL MUSIC COMPOSITIONS

Jeffery L. Briggs

### SOUND AND MUSIC PROGRAMMING

Ken Lagace  
Jim McConkey  
Scott Patterson

### DOCUMENTATION

James M. Day

### SUPPORT DOCUMENTATION

Sean M. Gallagher

### EDITOR

Merry L. Day

### PRINT MEDIA DIRECTOR

Iris Idokogi

### GRAPHICS

Cheri Glover  
Juanita Bussard  
George Gill

### LAYOUT

Michael Smith  
Iris Idokogi  
Susan Ullrich

### CHAPTER HEAD ILLUSTRATIONS

Stuart Stein

### QUALITY ASSURANCE

Chris Taormino  
Quentin Chaney  
Rob Snodgrass  
Anne Whatley  
Dave Shaefer  
Doug Whatley

### PACKAGING

Moshe Milich  
Jack Kammer

### SPECIAL THANKS TO:

Colonel George H. Stinnett, Chief Policies and Plans,  
Department of the Army, Washington, D.C.  
Major David A. Bartlett, U.S. Marines, NAVAIRSYSCOM  
Kenneth Holder and William Hayes, U.S. Army PAO,  
Fort Rucker, Alabama  
Gunnery Sergeant Steven Szewczyk, U.S. Marines,  
NAVAIR CH/MH53E  
Robert Finkenbinder, Air Defense Systems Division,  
General Dynamics Corporation  
Bell Helicopter Textron, Inc.  
McDonnell Douglas Helicopter Company  
Sikorsky Aircraft, Inc.  
Andy Hollis, Sid Meier and Arnold Hendrick - for  
developing the original Gunship ; it provided the  
driving spirit.



---

## CONTENTS

### INTRODUCTION

1. TUTORIAL.....	15
2. OPERATION INSTRUCTIONS .....	23
<b>Prepare for Flight</b> .....	23
Installation/Loading.....	23
Making Selections.....	23
Brigade HQ.....	24
Mission Briefing.....	30
Outfit Helicopters.....	32
Cockpit Switches.....	34
<b>Simulation Controls &amp; Views</b> .....	38
Simulation Controls.....	38
Simulation Views.....	39
Helicopter Controls.....	43
Flight Controls.....	43
Weapon Controls.....	45
Helicopter Gauges & Indicators.....	47
AH-64A/B Apaches.....	47
AH-66A Comanche.....	51
The Remaining Helicopters.....	51
<b>How to Fly</b> .....	53
Getting Airborne.....	53
Flight Techniques.....	54
Navigation.....	57
Landing.....	58
<b>How to Fight</b> .....	60
Flight Plan.....	60
Threats.....	60
On the Defensive.....	61
Damage.....	64
Helicopter Weapons.....	64
On the Offensive.....	66
Air-to-Air Combat.....	71

<b>Helicopter Flight Commands</b> .....	74
System Summary.....	74
Command Control.....	75
Communications.....	77
Strategy.....	78
<b>After the Mission</b> .....	80
Measure of Success.....	80
Mission Replay.....	81
Flight Promotions.....	83
Replacements.....	83
3. THE HELICOPTER.....	85
<b>History of Development</b> .....	85
<b>Flying the Helicopter</b> .....	101
<b>Helicopter Tactics</b> .....	108
4. EQUIPMENT AND ORGANIZATION.....	115
<b>Data Format</b> .....	115
<b>Your Helicopters and Weapon Systems</b> .....	117
<b>The Ground and Air Units</b> .....	129
<b>US &amp; Allied Units</b> .....	129
<b>The Opposing Forces</b> .....	136
APPENDIX.....	151
<b>Regional Deployments</b> .....	151
<b>Central Europe</b> .....	151
<b>The Persian Gulf</b> .....	153
<b>Weapon Characteristics Chart</b> .....	155
<b>Glossary</b> .....	158
<b>Notes</b> .....	164





# INTRODUCTION

## THE MISSION

All around you in the TOC sit the other squadron flight commanders; tension covers the area like a blanket. As you rip open your orders, the anticipation grabs at your gut, but you already know the score. No breaks here; your flight always pulls the tough assignments. Another SEAD mission deep into enemy territory. Those fast movers need you to clear the way again. Doesn't the TF know that your luck can't hold out forever? Sure, your success rate is the highest in the squadron, but...

You gaze at the mission map. The primary is 20 clicks behind enemy lines - they must be kidding. Your boys best be sharp tonight. Better get over to the armorer's tent. At least you'll get first choice on ordnance; being number one does have benefits. Apaches and Kiowa Warriors are on tap tonight. Plenty of Hellfires and Mark 261 MPSM rockets to go 'round. No need for any AA loads this trip. Is the opposition the only ones smart enough not to fly during these conditions? The S2 better be right on this one.

You climb into the rear seat of your Apache. You've never quite understood the feeling, but the closeness and tight fit is somehow comforting. You pre-flight the cockpit switches. You could run through this in your sleep, but SOP says otherwise - everything must be by the book. As you light off the APU your CP/G gives the thumbs-up. The other four pilots in the flight are looking to you for the sign. Although it's pitch black, you can still read the concern on their faces; but, they're good to go. Time to get these birds airborne. You key the commo switch, "Wind'em up!"

Three-quarters of the way there and no sightings. Just a milk run so far; lady luck must still be along for the ride. This is too good to last. You're getting a bit green-eyed from the glow of the FLIR's eyepiece, but without it you'd quickly get close and personal with some unforeseen hillside. Skimming the tree tops at 120 knots is quite a rush, but any kind of altitude spells nothing but bad news.

The MFD indicates that waypoint 3 is just ahead; time to to assume attack positions. Captain Arthur in Zulu-4 will lead the light section; as usual, the heavy section is with you - Zulu-1. Your call goes out, "Light section break right, heavy section left on me, weapons free." "Roger, breaking now," replies Zulu-4.

The APR-39 is starting to chirp, and those blips on the threat display definitely aren't friendlies. "Jack, select MPSM," you call to your front-seater over the ICS. "All units, prepare to unmask. Engage as they bear."

As you come up, the TAIDS paints a pretty picture of the target. There they are, big as you please - SA-13's and 'Zoo's'. But this is no time to admire the scenery, there's work to be done. "Targets bearing 335!" calls Jack not all too calmly. "Weapons in constraints, MPSM away!" you respond with equal gusto.

The rocket sub-munitions burst on the target with a tremendous white flash, followed by a series of secondary explosions. "Those guys are toast!" you hear Jack call out to no one in particular. So much for radio integrity.

You've certainly got their attention now. The threat display is going wild; enemy units are popping up at every clock position. The APR's radar warning indicator light turns a solid, glaring red as the klaxon blares in your headset. You're being tracked!

"Jammer active, chaff out! Peg him, Jack!" you call out while quickly pushing the Apache down and to the right. You glance over just as the enemy missile explodes harmlessly in the chaff cloud. "I'm on him. Switching to Hellfire," Jack responds. A short flash, and the Hellfire reaches out to find its target. Jack's head is glued to his display. He'll keep the target locked in the sight until the Hellfire impacts. A bright light blooms off to the left as the target evaporates from view. Scratch another one!

The ground explodes as rockets and Hellfires slam into the hapless targets. You know that it's only a matter of time. There's no hope for those guys; the surprise was too perfect.

Minutes later, not a single target is active. And, a good thing too as you've expended most of your ordnance. Its time to pull pitch and head for home. "Zulu's, form on me. Let's get out of here. Well done!"

Back at the TOC you and the other flight commanders are preparing for the debrief. As you sit and wait your turn, a smile slowly cracks across your face - just another successful mission.

You knew it all the time.

---

## OVERVIEW

Gunship 2000 is a detailed presentation of the art of present and near future helicopter combat operations. You can control just one or up to five distinct helicopters. The current and planned versions of the most prevalent U.S. Army helicopters are available for the choosing. Not just a bystander, you actually pilot one of the Army's top helicopters.

You start out as a Warrant Officer Candidate (WOC) at the Army Aviation Center, Fort Rucker, Alabama. Here you select your squadron and provide its nickname. More importantly, you get the necessary training to prepare you for the difficult challenge of helicopter combat. You determine the reality or difficulty of the training. It can be as simple or as hard as you desire; the advantage here, you can take your time and can't be damaged. Plus, you can return to training at any time to brush up on your skills.

Upon completion, you are promoted to Warrant Officer (W01), and move on to Single Helicopter Missions. Here you command and fly a single helicopter, in one of two theaters, against opposing forces in a variety of missions. The rank of a commissioned officer awaits your success; and upon receiving your commission, the door opens to the endless variety and challenge of Flight and Campaign Missions.

In the Flight Missions you are not only an active member of, but command a flight of five helicopters. You determine the mix of helicopters and ordnance necessary to complete the mission. How well you employ your own helicopter, plus command the other four helicopters determines the success or failure of the mission.

The Campaign Mission places you in a situation of continuous combat where mission after mission is thrown at you and your flight. While you can't win the campaign on your own, your success (or failure) does have an impact on its ultimate outcome.

Gunship 2000 offers all the thrill and excitement of modern helicopter combat in a visually accurate world of Topographical 3-D. Promotion, decorations and glory await you!

---

## **SORTING THE MATERIALS**

### **HOW TO START**

This Manual provides a tutorial for beginners, in-depth operating instructions, and a wide variety of tactical, historical and technical background.

The Technical Supplement provides specific instructions for the installation and/or loading of this simulation on your computer. It also acts as a complete reference guide for all of the graphics and keys used in the simulation.

The Keyboard Overlay(s) visually represents all of the controls and orders necessary for the operation of your helicopter and the computer itself.

---

## **INSTALLATION/LOADING**

The Technical Supplement provides complete instructions about how to install Gunship 2000 onto either a hard disk (strongly recommended) or floppy disks. See the "Installation" section for details.

In addition, the "Loading" section provides instructions for starting up the simulation. You'll be provided the opportunity to tailor the software to your system, specifically the controller type and sound options. If you have a joystick, we strongly recommend its use. However, it's not required - the entire simulation can be controlled from the keyboard.

---

## **LEARNING THE SIMULATION**

The first step is to become acquainted with actual helicopter flight systems. Read through "The Helicopter" (pages 85 - 114). In this section, the theory and practical application of helicopter flight is discussed. Those unfamiliar with any type of flight or familiar only with fixed-wing flight will find the information quite beneficial. With this information in hand, you are ready to proceed to the tutorial.



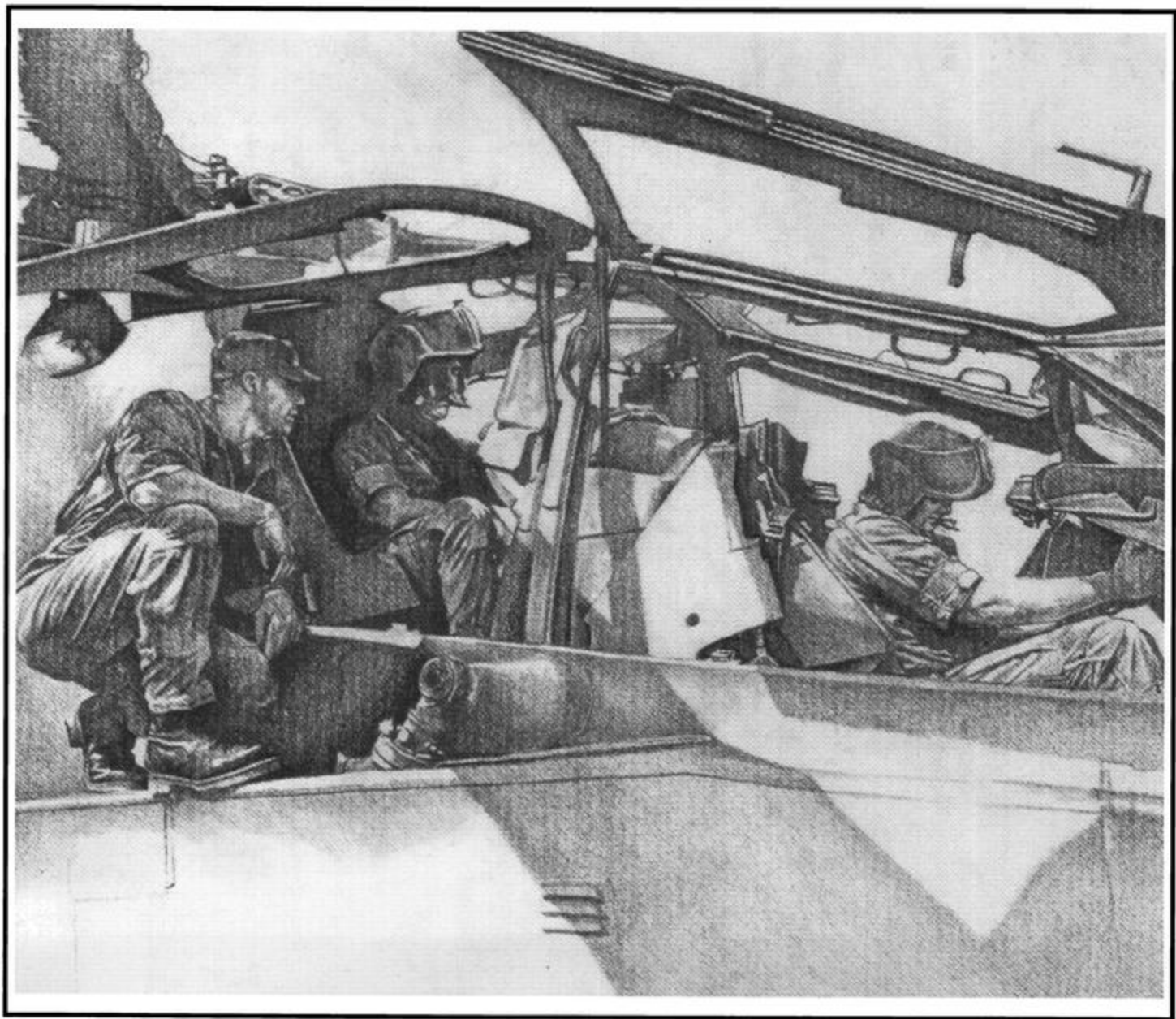



# 1. TUTORIAL

This tutorial enables you to strap on the seat of a helicopter and begin flying without digesting the entire manual. However, it neither provides you with the necessary insight to skillfully utilize the various weapon systems available, nor details the multiple helicopter operations. It familiarizes you with the basic controls and systems of the AH-64A Apache Gunship in a simple training flight against simulated opposing forces.

---

## GETTING STARTED

### INSTALLATION/LOADING

See the Technical Supplement for specific instructions for the installation, loading and configuration of this simulation on your computer.

---

### WHERE YOU START

After the title sequence, you'll find yourself at brigade headquarters. Various "action areas" are placed at positions around this screen. These "action areas" are accessed to select the various options available at brigade headquarters.

To select an option, use the controller to position the cursor over the desired "action area". When an "action area" is accessed, the cursor changes shape to a bull's-eye and the option's title is displayed at the bottom of the screen. Pressing *Selector #1* selects that option.

### DUTY ROSTER

As a new pilot, your first step is to get your name up on the Duty Roster. As part of this process, you also have the opportunity to select your squadron unit insignia and its nickname.

Position the cursor over the duty roster hanging on the back wall

#### CONTROLS CHART (BOX)

For compatibility across a wide variety of computers and control mechanisms, standard terms are used throughout. See the Technical Supplement and Keyboard overlay to interpret each for your computer.

**Controller:** A two-dimensional control device normally a joystick or the four-directional keys.

**Selector #1:** The first (left) button on a joystick. On the keyboard it's the Return or Enter key.

**Selector #2:** The second (right) button on a joystick. On the keyboard it's the Backspace key.

**Keys:** Each is referred to by an *italicized* name, which is shown on the keyboard overlay. In addition, a master list of names and keys for your computer is provided in the Technical Supplement

and press *Selector #1*. The “Duty Roster” screen now appears.

By positioning the cursor over any one of the six pilots, a detailed accounting of the flight commander and flight members, if any, is displayed in the top section. For now, you just want to get your name on the Duty Roster (for a detailed description of the Duty Roster, see pages 24 - 27).

Position the cursor over the “Erase Me” pilot and press *Selector #2*; then follow the instructions to enter your name and select your squadron and its nickname. Leave the cursor positioned over your new pilot (the corresponding data should be displayed in the top section) and press *Selector #1*. This selects that pilot and returns you to the brigade headquarters screen.

Notice that your pilot’s name and unit are now listed at the top of the Duty Roster.

## TYPE OF FLIGHT

Now position the cursor over the duty officer’s desk (he is sitting in the foreground) and press *Selector #1*. The “Type of Flight” screen now appears.

Since you’re in training, position the cursor over the “Training” and press *Selector #1*. This places you in the training mode and returns you to the brigade headquarters screen.

Notice that the duty officer is now holding an envelope marked “Training”; this envelope contains your orders for this training mission.

## THEATER OF DUTY

Now position the cursor over the world map located on the right wall and press *Selector #1*. The “Theater of Duty” screen now appears.

There are simulated training sites available for either of the two theaters - The Persian Gulf and Central Europe. Select the Persian Gulf (you will eventually want to fly training missions in both theaters) by positioning the cursor in the box outlining the theater and pressing *Selector #1*. You now return to the brigade headquarters screen; notice that the Persian Gulf theater is outlined on the world map.

## MISSION BRIEFING

You are now ready to start the training flight. Position the cursor over the door marked “Exit” and press *Selector #1*. The Briefing screen now appears.

It’s time to familiarize yourself with the Mission Orders. As you look out at the TF Commander, the top page of your Mission Orders is just visible at the bottom of the screen. Position the cursor on the page and press *Selector #1*. You are now looking down at the top page.

Since this is a training mission, some of the data is in abbreviated form;

however note two important areas.

First, are the "Primary Mission" and "Secondary Missions". Review the type or nature of the missions. Additionally, the position of your base and FARP are also indicated.

Position the cursor anywhere on the page and press *Selector #1*. The next page appears. This lists the support data about the position of your base, FARP, flight conditions and the S2's intelligence report.

Please note that the map coordinates are read military fashion, "right & up". The first number listed is on the horizontal scale, and the second is on the vertical scale. For example, 00/16 is in the upper left corner. Remember that maps are never 100% accurate. This is especially true when sighting mobile units.

Position the cursor anywhere on the page and press *Selector #1*. The mission map appears. This map indicates the relative positions of the different Primary Missions (P), your base (B) and FARP (F). Additionally, the map details the major terrain features and other areas of interest (for a detailed description of the mission map, see pages 41 - 42).

To review the Mission Orders, you may sequentially leaf through the pages any number of times. After review, position the cursor over the envelope and press *Selector #1*. The Briefing Screen now appears.

For this flight let's go with the armorer's recommended weapon load and begin the mission. Position the cursor over the map and press *Selector #1*. The Cockpit Switches now appear.

When Gunship 2000 is first installed, all of the switches are set at the lowest difficulty levels. Let's leave them that way for this flight. By positioning the cursor over a switch, a brief description of its function appears in the "Data Display" at the upper right (for a detailed description of the cockpit switches, see pages 34 - 39).

Located in the center of the screen is the "GPS Consol". Position the cursor over this area; the Data Display describes the Console's function and then displays the GPS Cipher as it appeared in your Mission Orders.

You're shown a Squadron Insignia along with a five digit number. These insignia and numbers are found between pages 21 & 60 of this manual. Find

## COCKPIT SWITCHES

the corresponding five digit Authenticator Code, and enter this number by pressing the appropriate numeric keys.

If the correct code is entered, the GPS Console displays "Signal Locked". You're now ready to start the mission.

If you can't find the correct code, you can still fly the mission, but the on-board GPS Map is disabled along with your weapons. Basically, you're on a sightseeing tour, but at least the view is breathtaking.

Now position the cursor over the "Aux Power Unit" switch. This switch starts the helicopter's engines, which begins the mission. It has a safety cover so that it won't be inadvertently activated. Press *Selector #1*, and the safety cover flips up. Press *Selector #1* again, and the power winds-up - your mission begins!

---

## AT THE CONTROLS

Now you're on the ground at your base, at the controls of an AH-64A Apache. You have a pilot's eye view of the world as you look out over the cockpit gauges and indicators. The following is an abridged version of the flight controls; it'll get you started in your first helicopter flight (for a detailed description of the flight and cockpit controls, see pages 47 - 51).

You start the training mission by taking off from your base, and end it by landing back at your base.

## GETTING AIRBORNE

At this point, it's a good idea to locate the pause (*alt p*) key. The frustration factor is much reduced if you pause the flight, read a section, perform the actions, pause again and read on further.

Your engines are already on line (the APU provided the necessary power to fire them up). Now engage the rotor; press the *Rotor Engage/Disengage* (9) key. The rotor indicator light turns from red to green, and the rotor starts to rotate.

Vertical movement is controlled by the Collective. Press the *Collective Up* (=) key a few times until the Apache starts to gain lift. When the altitude reaches approximately 200 feet, press the *Collective Down* (-)key to stabilize the lift.

Horizontal movement is controlled by the Cyclic. To move forward, push the *Joystick* (*up arrow*) forward. You now start to gain speed. By pushing the *Joystick* fully forward, the maximum speed for that altitude is attained. The *Joystick* need not be kept in a forward position to maintain forward flight; it's self trimming when centered.

Next push the *Joystick (right arrow)* slightly to the right. You bank and turn to the right. If you do the opposite, you bank and turn to the left.

Press the Map View (F10) key; the GPS map now appears. Don't worry, your Apache doesn't crash while you're viewing the map - the action is suspended.

## MAP VIEW

The GPS map displays the entire world in which you're flying. Notice that it matches the map you reviewed in your Mission Orders. Your Apache is positioned in the center of the map, and the first Primary Objective is just to the north.

Let's use the Apache's INS System to navigate to the target (for more information on the INS System, see pages 57).

Press the *F* key to select the *Fly To* command. Position the cursor over the first Primary Objective, and press *Selector #1* followed by the *Selector #2*. This enters that position into the INS System.

You can check the map at any time during a flight to verify positions. For now, press the *Selector #1* to return to the cockpit view.

The heading for the Primary Mission is displayed in the INS Indicator. More than likely, your true heading is different from the INS heading. Bank the Apache towards the INS heading indicator until the two heading numbers match. This new heading will take you to the first Primary Mission for gunnery practice.

Your Weapons Indicator (located at the lower left) should display "Cannon"; if not, press the *Weapon Select* (space bar) key until it displays "Cannon". You've now selected the Apache's M230 30mm Chaingun. It has a max range of 1,500 meters, but its optimum range is 700 meters dead ahead and half that for a "deflection shot" to the side.

## WEAPON SELECTION

Before you can fire at an opposing unit, the TADS must be locked onto the target. Look at the Threat Display (it's located in the lower right hand corner). If you're flying in the correct direction, there should be a red dot directly ahead. If not, adjust your flight path. Check the map to verify the placement of your waypoint.

## TARGETING

The TADS should be locked onto the target, a BTR-60 APC (the First Primary Mission). It's displayed, along with its identification, true heading and range data, in the MFD (located in the center of the cockpit). If the TADS isn't locked onto the target, press the *Acquire/Next Target* (selector #2) key.

When locked, a Target Diamond appears in your view along with the Reticle Ring. The Target Box indicates the exact position and heading to the BTR-60. The Reticle Ring is the aiming point of the cannon. To hit the target, the Reticle Ring must be superimposed over the Target Diamond. Adjust your flight path if necessary.

## TAKING THE SHOT

When the BTR-60 enters maximum range for the cannon, the Target Box changes from a broken box to a solid. This indicates that the selected weapon (the M230 cannon in this case) is now “in constraints”.

Keep the Target Box centered in the Reticle Ring, and let the range decrease. As the range decreases the Reticle Ring increases in size, indicating an increase in weapon accuracy. As you gain experience, you will eventually be able to determine weapon accuracy just from the size of the Reticle Ring.

When the range reaches about 700 meters, open fire by pressing *Selector #1*. You don't have to aim the M230 as it automatically tracks the target as long as the Reticle Ring is superimposed over the Target Box. After a few rounds, the BTR-60 is knocked out; you'll see its telltale explosion in the distance.

## RETURN TO BASE

Well that's probably enough action for this flight; let's return to base. Select the Map View, and set the INS System for a heading to the base.

Fly the Apache to a position directly over the base. When in position, pull back on the cyclic and allow your speed to drop to zero. Now press the *Collective Down* (-) key to start a slow descent on to the base. It's of no consequence if your descent is too fast, you can't crash on this flight. Perfect landings only come with practice.

Upon touchdown, press the *Rotor Engage/Disengage* (9) key (the indicator light now changes from green to red), and the rotor slows to a stop. This training flight is now at an end.

Good luck on your future flights!

26911	14104
60267	03279
15054	06621
78957	95892
72463	39850



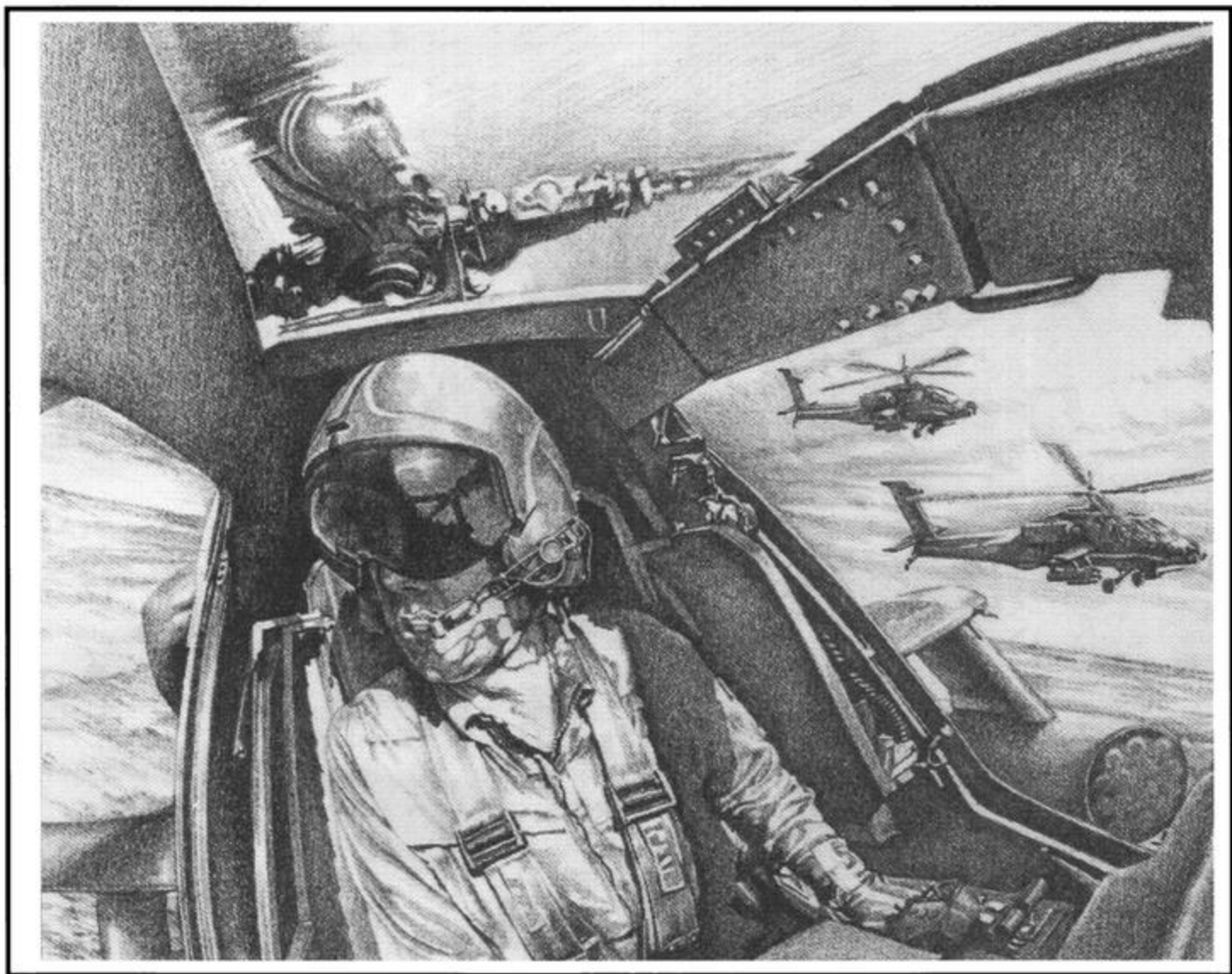

72463	43312
69240	46149
97662	91716
26911	44637
85924	38613



## 2. OPERATING INSTRUCTIONS

### PREPARE FOR FLIGHT

See the Technical Supplement for specific instructions for the installation, loading and configuration of this simulation on your computer.

### INSTALLATION/LOADING

Gunship 2000 provides for a large number of game options. These are presented in various screens in the form of "action areas" or in a menu format.

### MAKING SELECTIONS

When a screen first appears, the cursor will be positioned on the screen or over a menu selection. You move the cursor or change the menu selection by using the *Controller*. Once positioned over the desired option, it's selected by pressing *Selector #1*.

### USING A JOYSTICK

If your controller is a joystick, moving the stick up or down moves the cursor vertically; moving the stick left or right moves the cursor horizontally. Vertical and horizontal movement can be combined.

### USING THE KEYBOARD

If your controller is the keyboard, then any *Arrow key* moves the cursor to the nearest option; the tab key moves the cursor to the next option; the *shift Tab* key moves the cursor to the previous option; the Home key moves the cursor to the top of menus; and the *End* key moves the cursor to the bottom of menu listings. The keyboard can be utilized in conjunction with a joystick.

### ACTION AREAS

Most options are accessed via "action areas". These are placed at various positions around the different

#### CONTROLS CHART (BOX)

For compatibility across a wide variety of computers and control mechanisms, standard terms are used throughout. See the Technical Supplement and Keyboard overlay to interpret each for your computer.

**Controller:** A two-dimensional control device normally a joystick or the four-directional keys.

**Selector #1:** The first (left) button on a joystick. On the keyboard it's the Return or Enter key.

**Selector #2:** The second (right) button on a joystick. On the keyboard it's the Backspace key.

**Keys:** Each is referred to by an *italicized* name, which is shown on the keyboard overlay. In addition, a master list of names and keys for your computer is provided in the Technical Supplement.

49758	35098
84870	03058
56824	44551
67372	09355
59925	35356



screens. However, in some cases, menus are utilized where lists of data options are more functional.

To select an option, use the controller to position the cursor over the desired "action area". When an "action area" is accessed, the cursor changes shape from an arrow to a bull's-eye and the option's title displays at the bottom of the screen. Pressing *Selector #1* then selects that option. Menu options are selected in a similar manner; the selected option is highlighted.

Whenever an option is selected in error, pressing the esc key cancels the selection.

---

## BRIGADE HQ

All action begins at Brigade Headquarters, located at your home base. From this screen, the selections are made that determine the nature of your upcoming mission(s).

There are five "action areas" located at various positions around the screen, and these are accessed to make the various mission selections.

## DUTY ROSTER

Position the cursor over the Duty Roster hanging on the back wall and press *Selector #1*.

The duty roster is utilized to post the name of an active pilot, and flight members, if any, for the upcoming mission. The name of the posted, or active pilot always displays at the top of the Duty Roster.

What does it all mean: The Duty Roster is a detailed summary of a pilot's career and the careers of his flight members, if he is also a flight commander. By positioning the cursor over any one of the six pilots, that pilot is posted and a detailed accounting of the pilot and flight members then displays in the top section.

The pilot's name, rank, squadron insignia, squadron nickname, decorations awarded (numerals indicate multiple awards), missions flown and career score(s) display. If the pilot is a flight commander, the flight members are also listed along with their name, rank and decorations.

Base Screen

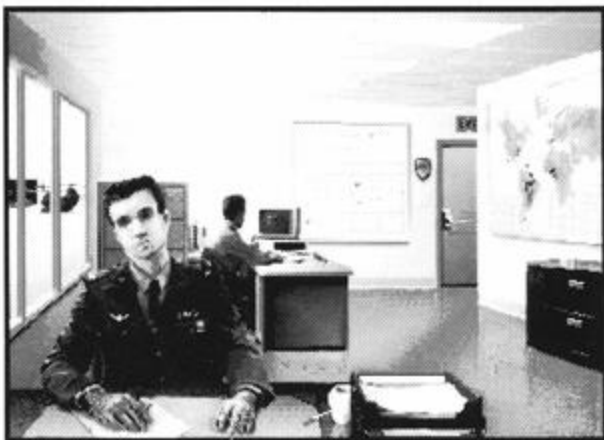

**Ranks:** Throughout a career, a pilot, including flight members, can advance through the ranks from Warrant Officer Candidate all the way up to Brigadier General. Ranks are indicated by a military abbreviation or by the actual rank insignia.

The military abbreviations correspond to the following ranks in order of achievement:

**WOC:** Warrant Officer Candidate

**W01:** Warrant Officer, W-1

**CW2:** Chief Warrant Officer, W-2

**CW3:** Chief Warrant Officer, W-3

**CW4:** Chief Warrant Officer, W-4

**2LT:** Second Lieutenant

**1LT:** First Lieutenant

**CAP:** Captain

**MAJ:** Major

**LTC:** Lieutenant Colonel

**COL:** Colonel

**BG:** Brigadier General

**Decorations:** For exemplary service, a pilot, including flight members, are awarded decorations up to and including the Congressional Medal of Honor. Decorations are displayed by an abbreviation and by the actual medal.

The abbreviations correspond to the following decorations:

**NDS:** The National Defense Service Medal - awarded for successfully completing training.

**PH:** The Purple Heart - awarded for wounds received in combat.

The following decorations are awarded for heroism and valor, and are listed from least difficult to achieve to the highest:

**ACV:** The Army Commendation Medal for Valor

**AMV:** The Air Medal for Valor

**BSV:** The Bronze Star for Valor

**SS:** The Silver Star

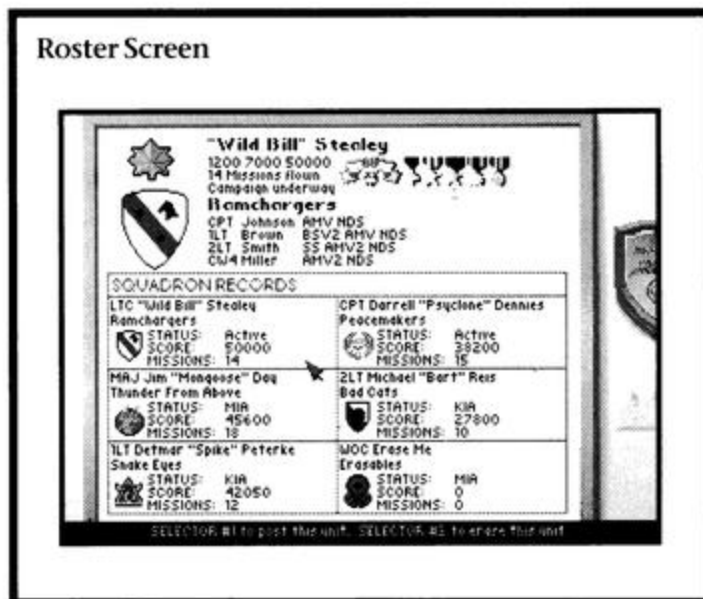

**DSC:** The Distinguished Service Cross

**CMOH:** The Congressional Medal of Honor

**Career Records:** There are three numerical values that summarize a pilot's career records. They represent, from left to right, last mission, best mission and total career.

**Status:** Pilots, and consequently their flight members, are classified by the current flight status. Only "Active" pilots can be posted for duty.

**Active:** Currently on active duty and good to go. You can have up to six "Active" pilots on the Duty Roster.

**Retired:** If you are successful enough to achieve the rank of Brigadier General, your country will ask no more of you. There's no more flying for you, and you'll be posted to a cushy desk job at the Pentagon.

However, if you've flown 99 missions without achieving the rank of Brigadier General, and very few do, you'll be retired from combat and posted to the Army Aviation Center at Ft. Rucker, Alabama as a pilot instructor.

**MIA:** If your helicopter goes down behind enemy lines, there's a chance you'll be lost or captured. As a result, you'll be classified as "Missing in Action".

**KIA:** If your helicopter suffers a catastrophic crash there's a chance you won't walk away from it. As a result, you'll be classified as "Killed in Action".

**Campaigns:** If your pilot and flight are currently engaged in a campaign, that information is displayed. Campaigns must be resolved before any other mission (except training) can be flown.

**New Pilot:** If you are creating a new pilot, you must permanently erase an existing pilot from the Duty Roster; so be careful who you select for erasure. An "Erase Me" pilot has been provided for your first entry.

Position the cursor over the "Erase Me" pilot and press *Selector #2*; follow the instructions to enter your name and select your squadron insignia and its nickname. Notice that your pilot's name and unit are now listed at the top of the Duty Roster. All new pilots start out at the rank of WOC.

Leave the cursor positioned over your new pilot (the corresponding data is displayed in the top section) and press *Selector #1*.

**Existing Pilot:** If you don't want to create a new pilot and want to continue the career of an "Active" pilot, position the cursor over that pilot and press *Selector #1*.

Position the cursor over the duty officer's desk (he is sitting in the foreground) and press *Selector #1*.

The open folder displays the available mission options:

**Training:** These missions are conducted at the training center, and are constructed to simulate the Theaters of Duty. The opposing forces are always positioned in the same manner so that various weapons and tactics can be tested.

Training missions simulate all helicopter operations with the following exceptions:

**No Damage:** You can't be hurt, as all of the opposing shots are simulated, and you walk away from all crash landings. However, the opposing weapons do behave normally, so you can still practice defensive measures.

**Career Record:** The Training mission does not count as a mission flown; you don't receive any score, promotion or decorations for heroism and valor.

Training missions can be flown at any time during a pilot's career, and, in fact, are the only alternative mission type that can be selected if a pilot is currently engaged in a Campaign. New pilots are not required to select Training, but if you do, at least you'll receive quick promotion to W01 and the NDS medal.

**Single Helicopter:** These missions send you out in a single helicopter against a real opposing force. While any pilot can fly these missions, pilots of any Warrant Officer rank are limited to Single Helicopter Missions.

During Single Helicopter missions, you're assigned a Primary, and more than likely, a Secondary mission. These missions can either be **Point Attack** or **Search & Destroy**.

**Point Attack:** You're directed to a specific target or targets with the objective to eliminate the targets.

**Search & Destroy:** The specific location of the targets is unknown or the targets are moving. You need to search the area described in your orders to find

## TYPE OF FLIGHT

the target units with the objective to eliminate them.

**Flight:** Once you have received your commission (ranks of Second Lieutenant and above), you are then eligible to command a multiple- helicopter flight. The other pilots in your flight are assigned to you from the force pool, and stay with you for the duration.

As with Single Helicopter missions, you're assigned overall missions. The missions include the two described above plus **Deep Strike, Tactical Support, Search & Rescue** and **Recon**.

**Deep Strike:** You're directed to a target or targets deep in enemy territory, far from your home base. We take care of getting you to the "passage point", but you must take it from there.

**Tactical Support:** You're called upon to pick-up or deliver troops or supplies to the battle area. There may also be wounded in need of immediate evacuation. While these "beans and bullets" missions may seem less sexy, they are none the less important. Besides, you may have to fight your way in and out. A UH-60K/L Blackhawk must be on tap to successfully complete these missions.

**Search & Rescue:** Friendly forces are in need of extraction, but must first be located. Not unlike Search & Destroy missions, but don't take any shots at these guys. The UH-60K/L Blackhawk must be on tap to successfully complete these missions.

**Recon:** The scouts lead the way here, as you're ordered to see what's out there. The OH-58D Kiowa Warrior, AH-66A Comanche or AH-6G Defender must be on tap to successfully complete these missions.

**Campaign:** This is a theatre-wide commitment for the long haul. You're placed in a situation of continuous combat where mission after mission is thrown at you and your flight.

Who knows how long it will last; there's no set schedule in combat. While you can't win the campaign on your own, your success (or failure) does have an impact on its ultimate outcome.

If you are a new pilot, it's best to choose Training as your first flight. In any case, position the cursor over the the desired mission type and press *Selector #1*.

Position the cursor over the world map located on the right wall and press *Selector #1*.

At this time, there are two theaters of operation available:

**Persian Gulf:** No pushovers here. The Iraqis are a well equipped foe. They possess a high degree of commitment and won't easily waiver. Additionally, flying in desert conditions presents a whole different set of factors.

As an added attraction, you and your flight may be call upon to stage from Amphibious Assault Ships located in the nearby waters. Your skill and special training aptly qualify you for this duty.

**Central Europe:** This region is the greatest challenge since you are up against the best the Soviet Union has to offer. They may be down, but they're not yet out. The region remains very unstable; the history books are yet to be written on what could transpire.

**Additional Theaters:** Gunship 2000 supports add-on theaters and their related forces and equipment. A number of potential areas are currently under consideration.

Make your selection by positioning the cursor in the box outlining the theater and press *Selector #1*.

While not an integral component of the mission selection process, the Squadron Archives certainly come into play over the course of a pilot's career. These records are kept in the filing cabinet located just beneath the Theater Map.

**Mission Films:** Position the cursor over the top drawer and press *Selector #1*; this drawer contains the saved mission replay films. During mission debriefing you're given the opportunity to save the mission replay for later viewing.

Positioning the cursor over a film title and pressing *Selector #1*, selects the film - press play to replay the film.

You may also exchange mission films with your friends - this way you can show them what real pilots do in their spare time.

Duty Roster: Position the cursor over the bottom drawer and press *Selector #1*; this drawer contains the pre-mission Duty Roster.

We've all been in the situation where a single mistake has resulted in a life ending crash, or at the very least fast-tracked our careers to oblivion. This always seems to happen when we're just on the verge of a major promotion.

In the past, quick reboots or DOS copies of the roster were the only alternatives around this dilemma. Now you can use this option to restore the Duty Roster to its state just prior to the last mission flown. Its like the mission never happened - we all need a few breaks once in a while.

One warning - you must actually fly the mission before you can restore the Duty Roster; this doesn't save you from the stigma of refusing to fly a mission.

You're now ready to attend the mission briefing. Before you leave, make one last scan of the screen to verify your selections; once you leave, you're committed.

When ready, position the cursor over the door marked "Exit" and press *Selector #1*.

## EXITING BRIGADE HQ

---

## MISSION BRIEFING

Depending upon the Theater selected, you now find yourself in simple surroundings among the lush green hills of Central Europe or on the stark sands of the Persian Gulf. As a matter of course in the Persian Gulf, you may also find yourself in the ready room of an Amphibious Assault Ship.

There are three "action areas" located at various positions around the screen.

The top page of your Mission Orders is just visible at the bottom of the screen. Position the cursor on the page and press *Selector #1*.

These four pages not only detail the upcoming mission, but also provide important intelligence data about the opposing forces. It's very important to read your orders carefully. Press *Selector #1* to leaf through the pages.

## MISSION ORDERS



94144	78663
59925	28846
26911	67929
57925	31831
56824	96229



**Call Sign:** It's based on the phonetic military alphabet; you're always number "1".

**Primary Mission:** This is the "primary" reason this mission exists, and why you're being sent out. Make sure that you understand the components of the primary and its requirements for completion. Its general location is indicated on the mission map with a "P".

**Secondary Mission:** More than likely, a "secondary" is also assigned; its presentation is the same as your Primary. Although classified a Secondary Mission, it's still important. You can complete it first, but don't forget the primary. The Secondary Mission's general location is indicated on the mission map with an "S".

**Base:** This is where you will start and finish the mission. Its location is indicated on the mission map with a "B".

Note that on Deep Strike missions, your base is somewhere off the mission map. You start on the edge of the world at the "Passage Point"; this is expressed as two coordinate values. This is the only safe exit from the mission.

**FARP:** If a "FARP" is available, its location is indicated on the mission map with an "F". You may land at a FARP to replenish fuel and weapons.

**S-2 Report:** The S-2 gives you his best estimate (guess?) about the opposing force's equipment. Pay special attention to the availability of opposing helicopters.

**Conditions:** The meteorological section gives you a brief report on the expected weather conditions in the flight area. How these conditions affect flying is dependent upon the flight switch settings.

**Mission Map:** This is the flight area for the current mission. All of the key points of interest are indicated on the map.

Please note that the map coordinates are read military fashion, "right & up". The first number listed is on the horizontal scale, and the second on the vertical scale. For example, 00/16 is in the upper left corner. Remember that maps are never 100% accurate. This is especially true of ground unit and mobile base sightings.

### Tent Screen

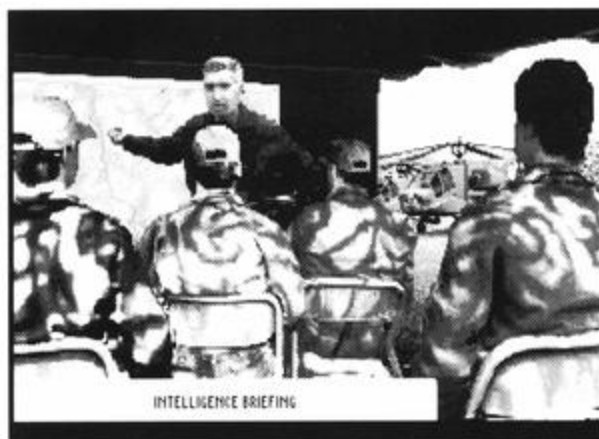

**Decline Mission:** In the event you really don't want to fly this mission, you can opt to pass it along to someone else and request new orders. If currently engaged in a campaign, this page provides the mechanism to suspend or abort the campaign and return to Brigade HQ.

To review the Mission Orders, you may sequentially leaf through the pages any number of times. After review, position the cursor over the envelope and press *Selector #1*.

---

## OUTFIT HELICOPTERS

The squadron armorer routinely places the recommended helicopters, with ordnance, on the flightline. You can accept his recommendations or change any or all of the helicopters and ordnance. To review, position the cursor over the helicopters in the background and press *Selector #1*.

This provides a complete overview of the pilot assignments, helicopters and their respective ordnance. From this screen, you may shift the pilots and/or helicopters to other positions and also assign section leaders.

## OUTFIT SUMMARY

**Swap Pilots:** Position the cursor anywhere in the first pilot's summary section and press the *p* (Swap Pilots) key; the pilot's outline now starts to flash. Position the cursor in the second pilot's summary section and again press the *p* (Swap Pilots) key. There's just one restriction, you must occupy the #1 position. After all, you're the flight leader.

**Swap Helicopters:** Position the cursor anywhere in the first helicopter's summary section and press the *h* (Swap Helicopters) key; the helicopter's outline now starts to flash. Position the cursor in the second helicopter's summary section and again press the *h* (Swap Helicopters) key.

**Duplicate Helicopters:** Position the cursor anywhere in the first helicopter's summary section and press the *d* (duplicate helicopters) key; the helicopter's outline now starts to flash. Position the cursor in the second helicopter's summary section and again press the *d* (duplicate helicopters) key.

**Section Leaders:** Your flight may be organized or "sectioned" into one section of five or into two smaller sections. The section of three is the "Heavy Section";



67372	53143
97662	14806
94144	17640
34620	10929
49758	93721

the other section of two is the "Light Section". Sections fly as a single group, which greatly facilitates flight commands.

You're always a section leader; the pilots occupying positions #3 and #4 may alternately be assigned as a section leader. Position the cursor anywhere in the pilot's summary section and press the I (Assign Section Leader) key.

The Heavy Section is identified by a blue band and the Light Section by a grey band.

Return to the Mission Briefing screen when satisfied with the mix, but first, read on.

If you want to change a helicopter's ordnance, or change the actual helicopter, position the cursor anywhere in the helicopter's summary section and press Selector #1. The Arming Screen displays the current helicopter along with its ordnance.

**Weapons:** A brief description of each weapon displays at the upper right; for a more complete description see pages 67 - 68.

To select a weapon, highlight it and press *Selector #1*; then select the appropriate option among those available. Existing weapons can be directly replaced; the existing weapon doesn't need to be first removed.

Most helicopter weapons are balance loaded; whenever you add or subtract a weapon to one position, its twin automatically loads on the opposite wing. The Defender and Kiowa Warrior are exceptions; their pylons can carry different weapons.

**Fuel:** Highlight "Fuel" and press *Selector #1*. Expressed as a factor of 100%, fuel is increased or decreased as desired. While it's real tempting to trade fuel for weapons, don't leave yourself short; it's very embarrassing if you have to walk back.

**Ammo:** This only applies to helicopters with integral cannons

## ARMING

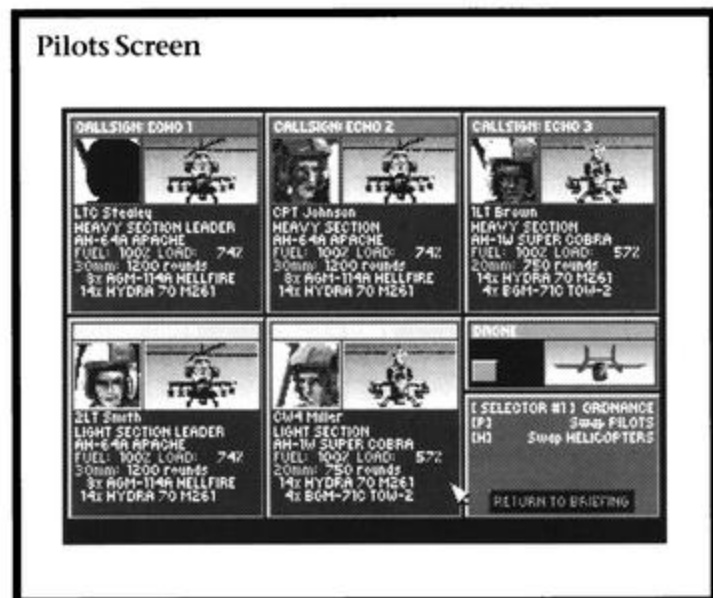

or machine-guns. Highlight “Ammo” and press *Selector #1*. Ammo is loaded to the maximum, or any lesser amount.

**Chaff/Flares:** Highlight “Chaff/Flares” and press *Selector #1*. A mix of 60 chaff & flares are carried.

**Load:** All helicopters are rated for a maximum load capacity; this value is expressed as a factor of 100%. Theater and weather conditions affect the maximum load capacity of a helicopter. It decreases as temperature and humidity increase, and is further reduced by low atmospheric pressure. Load capacity is also reduced at higher altitudes as air becomes thinner as altitude increases.

The load capacity is automatically calculated for each helicopter, but of course, varies by the theater and mission conditions. As you change weapons or increase/decrease Fuel or Ammo (the chaff & flare mix doesn't impact load) the load capacity changes. You can load ordnance in excess of 100%, but the load must be 100% or less before you exit the arming sequence.

A load of less than 100% is desirable since more reserve power is then available.

**Change Helicopter:** Highlight “Change Helicopter” and press *Selector #1*. Select the new helicopter by highlighting it and pressing *Selector #1*. New helicopters always arrive on the flightline “clean” (without ordnance).

Return to the Outfit Summary screen when satisfied with the mix; highlight “Ordnance Complete” and press *Selector #1*.

## EXITING MISSION BRIEFING

You're ready to start the mission. Position the cursor over the map and press *Selector #1*.

Note that during campaigns, this map is used to advise you of the current state of a campaign. The degree of victory or defeat is indicated by how far the blue side (friendly) or the red side (opposing) has advanced beyond the original front line.

---

## COCKPIT SWITCHES



60267	06150
78957	73031
85924	91974
56824	32998
69240	30445

You preflight, or set, the Cockpit Switches to determine the overall “reality” or difficulty of the upcoming mission. Many different switch combinations allow you to tailor the settings to your own particular needs. You must also enter the

GPS Authenticator Code to activate on-board systems.

There are nine “action areas” located at various positions around the screen. The “Data Display” in the upper right corner displays a brief description of each switch whenever an action area is accessed. Change switch settings by positioning the cursor over the switch and pressing *Selector #1*.

## CP/G CONTROLS

This assigns duties to your invisible CP/G, and enables you to concentrate on other activities.

**Weapons/C.M.:** The CP/G automatically fires all weapons. The CP/G additionally activates the appropriate counter-measures systems as needed.

**C.M.:** The GP/G controls just the C.M. systems.

**None:** You control all weapon/C.M. systems.

While the CP/G does an adequate job, you will eventually want to control all systems yourself.

## ENEMY QUALITY

This determines the competency level and training of the opposing forces. It has a direct correlation with how quickly an opposing unit can achieve a lock on your helicopter, and the relative accuracy of its weapons. Units of lower quality are also more reluctant to pursue an objective in the face of stiff resistance.

**Poor:** These guys are best described as rabble. A civilian force could probably do just as well. Not much to worry about here, you can mop up these troops with no trouble. A good first opponent for new pilots.

**Average:** These are your basic every day troops. Certainly not exemplary, but at least they're not the bottom of the barrel.

**Crack:** Now we're starting to talk competence. These guys

## Ordnance Screen

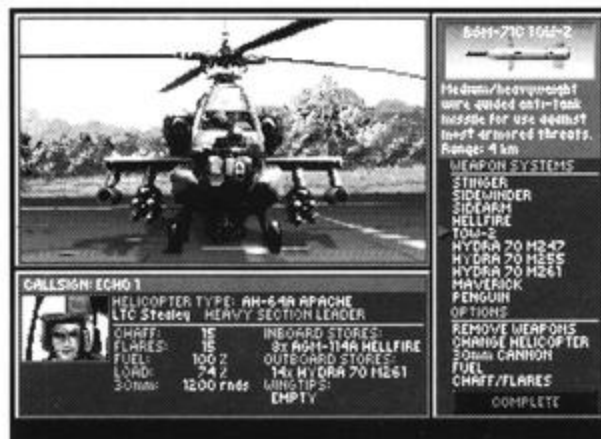

## Reality Switch Screen



know their business, and are a real challenge. They are aggressive and clever. Don't assume anything.

**Elite:** The best-of-the-best. Not much more need be said about these troops. They go to any lengths to accomplish their objectives or to stop you from accomplishing yours. You need to be exceptionally quick and skillful to get the upper hand.

## FLIGHT

This switch sets the flight mode parameters of your helicopter.

**Easy:** The pitch, roll, altitude and airspeed of the helicopter have no effect on lift. No matter how you maneuver the cyclic (joystick), lift, and therefore, your altitude is unaffected. The collective is the only control that affects lift/altitude.

**Realistic:** Here the pitch, roll, altitude and airspeed affect lift as in a real helicopter.

## LANDINGS

This switch sets the difficulty level or "forgiveness" associated with your landing attempts.

**No Crashes:** All landings are perfect.

**Realistic:** Landings need to be within the design specifications of the helicopter; if not, damage or destruction could result. Easy does it.

## AVOIDANCE

This switch turns the on-board collision avoidance system on or off.

**On:** The helicopter automatically avoids all intervening terrain features, thereby preventing instant destruction on hillsides. The system avoids the objects by gaining altitude, so don't deliberately fly at tall mountains; it can't protect you from bullets.

**Off:** You're on your own, so keep alert. The radar altimeter is probably your best friend.

## WIND

This switch activates or deactivates wind effects.

**No Wind:** The flight conditions are calm and serene.

**Realistic:** The wind is blowing across the battle field at the velocity and bearing indicated in the Mission Orders. Your helicopter displaces an equal amount to the wind.

This switch's setting determines the probability of naturally occurring (fog, rain, etc.) or man-made conditions (smoke) obscuring visibility or limiting the effectiveness of visiononics equipment.

**Clear:** Visibility is unlimited.

**Realistic:** Visibility can be limited by battlefield obscurants.

The combination of theater, mission type and switch settings determines the overall difficulty level of the upcoming mission. The higher the difficulty level, the greater the challenge, but the potential reward is heightened.

The "Difficulty" indicator provides a visual gauge of the difficulty level. When fully illuminated, the mission is of extreme difficulty. The indicator is unilluminated, regardless of the settings, for Training Missions, as no score is awarded.

Located in the center of the screen is the "GPS Consol". Position the cursor over this area. After the Data Display describes the Console's function it then displays the GPS Cipher as it appeared in your Mission Orders.

You were shown a Squadron Insignia along with a five digit number. These insignia and numbers are found between pages 21 & 60 of this manual. Find the corresponding five digit Authenticator Code, and enter this number by pressing the appropriate numeric keys.

If the correct code is entered, the GPS Console will display "Signal Locked". You're ready to start the mission.

If you can't find the correct code, you can still fly the mission, but the on-board GPS Map are disabled along with your weapons.

Now position the cursor over the "Aux Power Unit" switch. This switch is used to start the helicopter's engines and begin the mission. It has a safety cover so that it won't be inadvertently activated; it requires two keystrokes to activate. Press *Selector #1*, and the safety cover flips up. Press *Selector #1* again, and the power starts to wind-up.

## VISIBILITY

## DIFFICULTY

## GPS SYSTEM

## APU

85924	08334
66391	49159
84870	80422
72463	70783
34620	39186



---

## SIMULATION CONTROLS AND VIEWS

### SIMULATION CONTROLS

A number of commands are available to control “overhead” or various game functions. While these commands can be utilized at any time, some relate to specific functions, and have no effect.

#### PAUSE

Press the *Pause* (alt p) key to immediately freeze the action. Some computers have specific “pause” or “hold” keys. Depending on the internal design of your computer, these keys may also work. Pause is only effective during flight.

#### JOYSTICK ADJUST

Gunship 2000 supports either a joystick or the keyboard for all game functions. If you’re using a joystick, the keyboard also remains active.

If your joystick seems to be “drifting”, press the Joystick Adjust (alt j) key, with the joystick centered, to re-calibrate.

#### DETAIL ADJUST

If you have a slower computer, you may use the Detail Adjust (alt d) key to access the selection menu. The simpler detail levels increase the processing speed. The action is temporarily suspended when making the selections.

#### QUIT TO DOS

Press the *Quit* (alt q) key to immediately end the simulation and return the system to DOS. No information, including current scores or settings, is saved to disk. Scores and settings are automatically saved at the completion of each mission, so only the current data is affected.

#### END MISSION

Press the *End Mission* (alt e) key to end the current mission. The computer projects the current situation into the immediate future, and determines the results. Therefore, you can’t use this key to escape from impending disaster; and the results do count as a mission flown.

#### VOLUME ADJUST

The *Volume Adjust* (alt v) key accesses the sound effects selection menu. The action is temporarily suspended when making the selections.

#### CO-PILOT SOUND

Your invisible co-pilot communicates system status and threat/target information to you via digitized sound. While these prompts are quite helpful, there’s a price to pay in computer processing speed. If you find your system slowing too dramatically, pressing the *Co-Pilot Sound* (alt c) key turns these sound off.



The other section leader or pilots communicate with you during the course of a mission. These messages stay visible for only a short period of time. If for some reason you are unable to review an entire message (you could be busy with some bad guys of your own), pressing the *Last Message* (alt m) key re-displays the text.

## LAST MESSAGE

In addition to the processing speed gained by adjusting the detail, the style of the cockpit can be adjusted to increase performance. Press the *Cockpit Style* (alt s) key to access the selection menu. The action is temporarily suspended when making the selection.

## COCKPIT STYLE

Press the *Accelerate Time* (I) key to increase the rate at which time passes, therefore increasing the speed of your flight. This is a variable setting of 16 levels. Each successive press of the key increases the speed one level. This function is best used in combination with auto-pilot mode.

## ACCELERATE TIME

Press the *Normal Time* (I) key to immediately return to normal time; it can't reduce the rate to less than normal time. Flight automatically returns to normal time whenever a target is sighted or upon reaching the final waypoint.

## NORMAL TIME

---

Gunship 2000 offers a number of different points of view while flying. You can jump from inside the cockpit to a point of view outside or even ride a Hellfire into its target.

## SIMULATION VIEWS

These views are from inside of the cockpit looking out. These are your "true" views.

## FROM-THE-COCKPIT VIEWS

**Cockpit (F1):** This is your normal from the cockpit view. From this you see the gauges and controls of the cockpit panel. When engaging in combat, this is the most advantageous point of view, as you have the aid of the weapon targeting systems.

**Mast (F2):** The OH-58D Kiowa Warrior, MD530G Defender and AH-64B Longbow Apache are equipped with mast mounted sights. They're used to peer over the tops of obstacles while keeping the body of the helicopter hidden and safe from opposing eyes and more importantly, opposing weapons.

They're best employed from hover mode (the auto-hover mode holds your position), as you really can't mask behind terrain in forward flight. When

## OUT-OF-COCKPIT VIEWS

activated, the controller is utilized to rotate the sight, left or right, through 360°, not to control helicopter flight.

**Left (F3):** View from out of the left cockpit window.

**Right (F4):** View from out of the right cockpit window.

As an aid to flight maneuvers and combat, a variety of external views are available. In all of them, you're "out-of-the-cockpit" looking at your helicopters and/or the targets.

**Chase (F5):** You're positioned just behind your helicopter, looking past it at whatever lies ahead. You maintain this perspective no matter how the helicopter is maneuvered.

**Flight Chase View (shift F5):** You're positioned just behind one of your pilot's helicopters looking past it at whatever lies ahead. You maintain this perspective no matter how the helicopter is maneuvered. Press the key again to shift your view to the next helicopter.

**Tactical View (F6):** You're positioned just behind your helicopter, looking past it at the target. This view automatically rotates and pans to keep both the helicopter and target in view.

This view is helpful when engaging air targets, and is also useful if you want to return for a second or third pass at a ground target. It's probably wise to return to the cockpit before firing, so as not to waste ammunition.

**Remote View (F7):** You're positioned just off from your helicopter; your helicopter continues its flight. This view automatically rotates and pans to keep your helicopter in view. It's not unlike the view of a radio-controlled flight.

Additionally, by pressing and holding *Selector #2* and adjusting the controller, you can shift your point of view. Holding *Selector #2* maintains that point of view.

**Reverse Tactical View (F8):** You're positioned just behind your helicopter's target, looking past it at your own helicopter. The target can either be an air or ground unit - whatever you're locked on. In either case, the target is in the foreground, and your helicopter is in the distance. In fact, it may only be a dot



69240	09160
26911	67975
34620	66516
60267	57108
66391	20136

in the sky. This view automatically rotates and pans to keep both the target and your helicopter in view.

Experienced pilots find this a very dramatic view when making attack runs at ground targets. It's a great view to showoff, but keep in mind that your helicopter is still flying; don't crash into a hill while admiring the view.

**Missile View (F9):** You're positioned directly behind the weapon just launched. This view is very entertaining, as you follow the weapon directly into the target. If you're having trouble understanding why your weapons are missing, switching to this view can be very helpful.

### MAP VIEW

When the Map View (F10) key is pressed, the GPS map appears. Your helicopter won't crash while you're viewing the map, since the action is suspended.

The GPS map displays the entire world in which you're flying in low and high scales. The high scale map is the default display. Note that it matches the map provided in your Mission Orders.

This map displays the positions of all friendly units and the positions of sighted opposing units. Current sightings display in bright red, while old sightings display in dark red. Remember that the opposing forces may be moving, so don't rely on old sightings. Icons are used to mark the sightings.

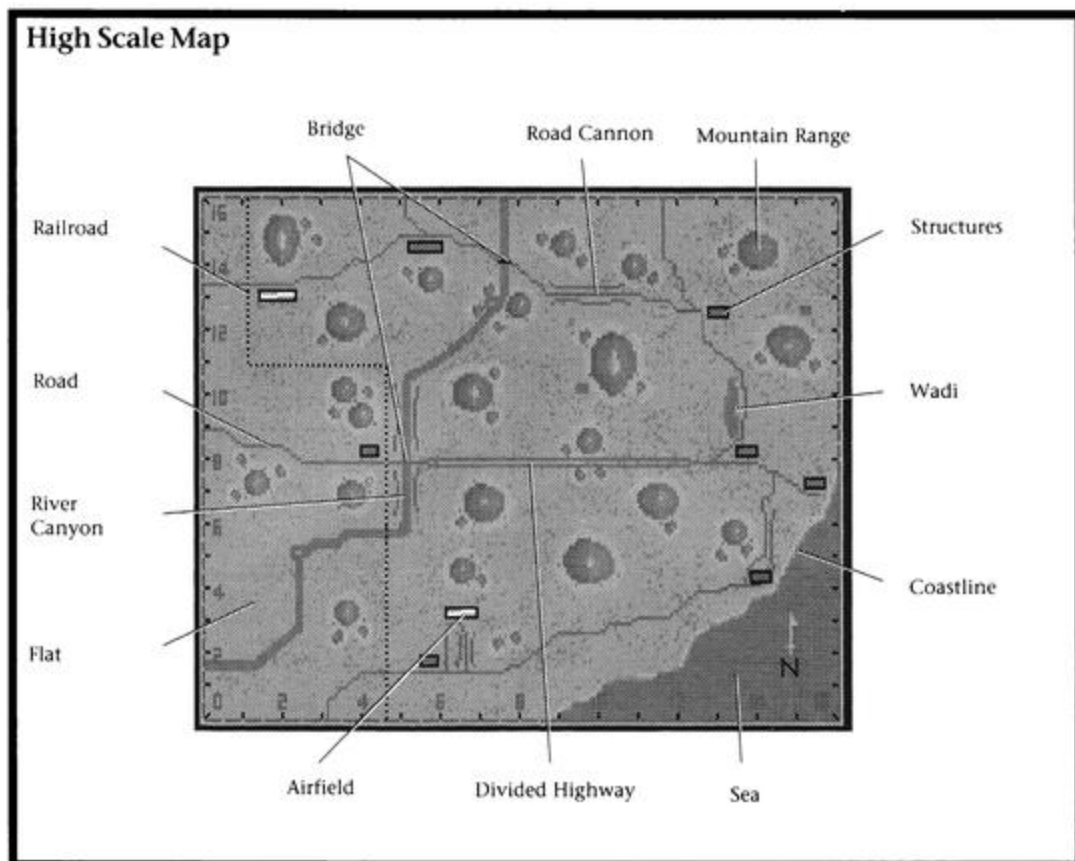

57925	56524
49758	34578
78957	23866
84870	02538
94144	29352



## Low Scale Map

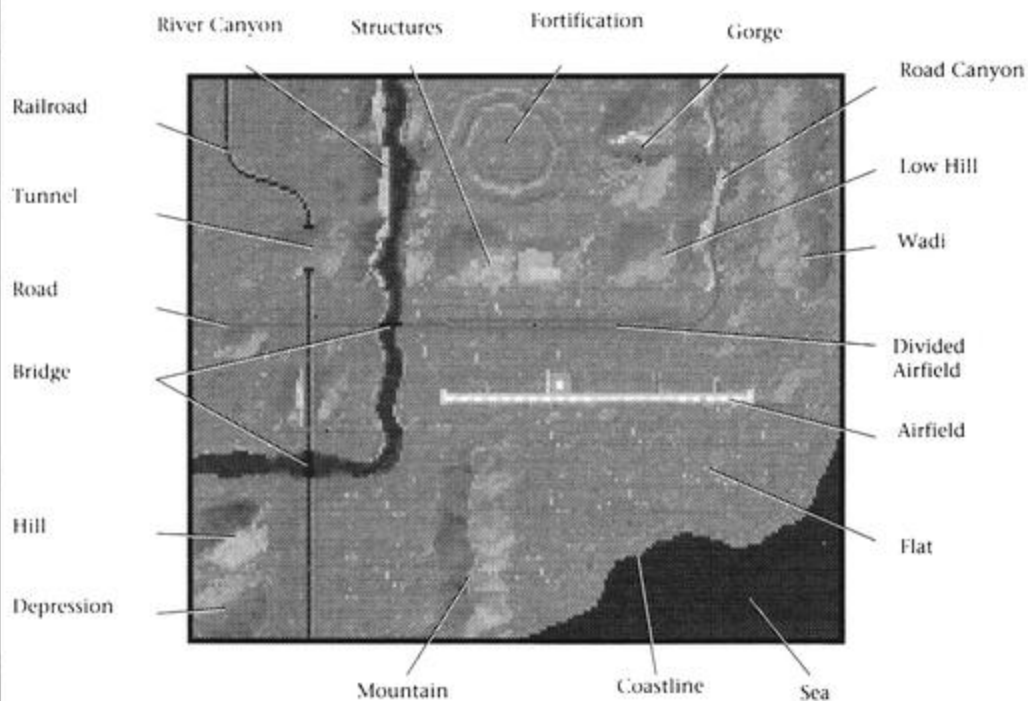

The different terrain features are depicted on the high scale maps. These come in many shapes and sizes, and vary from world-to-world. Terrain is the number one defensive measure. Get familiar with the different terrain types, and use them to your advantage.

Press the *spacebar* to switch to the low scale mode. The low scale maps depict specific terrain features. Where the large scale map indicates a mountain group, the small scale map depicts the actual mountains of the group. The displayed area is scrolled by moving the *Controller* in any direction. A reduced version of the large scale map displays in the upper right corner; the yellow indicator "boxes" the display area. Press the *spacebar* to return to the high scale map, or the *esc* key to return to flight mode.

## Map Icons

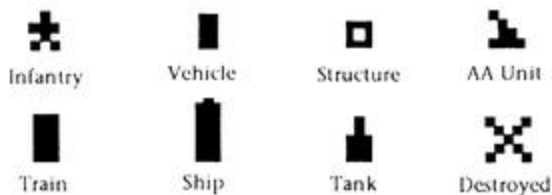

---

## HELICOPTER CONTROLS

A number of controls and flying aids are available to you as a pilot. The following describes and defines how each works; but do not use this section as a guide to flying, see "How to Fly", pages 53 - 59.

Pushing the *Joystick (up Arrow)* forward pitches the helicopter's nose down. Pulling the *Joystick (down arrow)* back pitches the helicopter's nose up. Pushing the *Joystick left (left arrow)* or right (*right arrow*) rolls the helicopter in that direction.

A downward pitch moves the helicopter forward; a large down pitch causes a faster dive in Realistic Flight mode. An upward pitch moves the helicopter backwards.

Rolling the helicopter left or right at extremely low speeds (under 10 knots) causes the helicopter to rotate left or right. At low speed (under 40 knots), it causes a skid or "sideslip" left or right. At medium or high speed, it causes a banking turn left or right.

The Artificial Horizon Gauge shows the current pitch and roll of the helicopter.

Lift keeps the helicopter airborne. In level flight, increasing the collective causes the helicopter to ascend, while decreasing the collective causes the helicopter to descend. The current level of the collective is measured as "torque". When raising or lower the collective, the engine torque/throttle is automatically adjusted.

To raise or lower the collective, press the *Collective Up (=)* or the *Collective Down (-)* keys respectively. To raise or lower the collective fast, press the *shift Collective (= or -)* keys.

The Torque Gauge indicates the current level of torque.

Press the *Gear (3)* key (AH-66A Comanche only) to toggle your landing gear up or down. Flying with the gear down not only reduces airspeed, it increases the radar cross-section.

The Gear Indicator Light is illuminated when it's down.

## FLIGHT CONTROLS

### CYCLIC STICK

### COLLECTIVE

### GEAR

## AUTOPILOT

Press the *Autopilot* (5) key to engage or disengage the autopilot. When engaged, it flies you to the “active” INS waypoint; if no waypoints are set, the autopilot doesn't engage. When engaged, the autopilot locks in your current altitude and speed. However, if your altitude is less than the Low Limit, the Auto-Pilot climbs the helicopter to that altitude. If the cyclic stick is moved in any direction, the autopilot automatically disengages.

The autopilot Indicator Light illuminates when it's engaged.

**Warning:** the autopilot doesn't avoid hills or obstacles (unless Collision Avoidance is engaged); it flies a straight line from waypoint to waypoint.

## NEXT WAYPOINT

Press the *Next Waypoint* (6) key to immediately switch to the next waypoint. This can be selected while the autopilot is engaged.

## PREVIOUS WAYPOINT

Press the *Previous Waypoint* (7) key to immediately switch to the previous waypoint. This can be selected while the autopilot is engaged.

## BAY OPEN/CLOSE

Press the *Bay Open/Close* (8) key (AH-66A Comanche only) to open or close the weapons bay. The Comanche's internal weapons, except for the 20mm cannon, can only fire when the bay is open. However, when open, it increases the radar cross-section.

The Bay Indicator Light is illuminated when it's open.

## ROTOR ENGAGE/DISENGAGE

Press the *Rotor Engage/Disengage* (9) key to engage the rotor (cause the engines to turn the rotor), or disengage the rotor (cause the rotor to spin freely, unconnected from the engines) When it's disengaged, the collective is automatically “bottomed” (set to zero).

The Rotor Status Light indicates if the rotor is engaged (green) or disengaged (red). The light flashes red if you attempt to add collective with the rotor disengaged.

## AUTO-HOVER

When flying at a speed from +10 to -10 knots, pressing the *Auto-Hover* (0) key automatically places the helicopter in hover mode; your speed is automatically reduced to zero. The collective controls can be used normally, but auto-hover doesn't allow the altitude to drop below the Low Limit. Therefore, you can't land with auto-hover engaged. If the cyclic stick is moved forward or back (you may still rotate left or right), auto-hover automatically disengages.

The auto-hover Indicator Light illuminates when it's engaged; it flashes when engaged at too high a speed

Auto-hover is very useful to maintain a position during windy conditions or to unmask and quickly mask from cover. You can drop altitude like a rock, since auto-hover holds you at the Low Limit Altitude.

Press the *One or Left MFD* (z) key to change the information displayed in a single or the left hand MFD. Helicopters with a single MFD have five possible displays: navigation (heading & waypoint data), low scale map, mission orders, weapons status or target camera. The target camera automatically displays, overriding any other display, whenever a lock-on occurs.

**ONE OR LEFT MFD**

Helicopters with two MFD's add a sixth option - threat display.

Press the *Right MFD* (x) key to change the information displayed in the right hand MFD. Helicopters so equipped have six possible displays: navigation (heading & waypoint data), low scale map, mission orders, weapons status, target camera or threat display. The threat display automatically displays, overriding any other display, whenever a target is detected.

**RIGHT MFD**

Press the *Low Limit* - (c) key to decrease the low altitude limit by 50 feet; it can not be reduced below 50 feet. Both the barometric and radar altimeters utilize the low limit setting as the basis for low altitude warnings. Audio and visual indicators are activated whenever the altitude falls below the low limit.

**LOW LIMIT**

In addition to its function as a flying aid, the low limit is used to set the flying altitude of independent helicopters and/or sections.

Press the *Low Limit +* (v) key to increase the low altitude limit by 50 feet; it can not be raised above 250 feet.

**LOW LIMIT +**

---

A number of weapon controls are available. The following describes and defines how each works. Do not use this section as a guide to combat, see "How to Fight", pages 60 - 73.

**WEAPON CONTROLS**

Press the *Rocket Salvo x1, x2 or x4* (1, 2, 4) keys to set the number of Hydra 70 unguided rockets that will be fired from each wing pod whenever "rockets" are selected and *Selector #1* is pressed. Rockets are fired symmetrically from both wing pods, except for the Kiowa Warrior and Defender. The salvo mode is shown in the Weapons Display.

**ROCKET SALVO X1, X2, X4**

## ACQUIRE/NEXT TARGET

Press the *Acquire/Next Target* (back space) key to lock onto a target or to switch the current lock-on. Normally, the targeting system automatically locks onto the nearest target; this enables you to switch to an alternate target.

If no other targets are present, the lock-on remains with the current target. The target system toggles through the potential targets from nearest to farthest.

## RADAR JAMMER ON/OFF

Press the *Radar Jammer On/Off* (n) key to toggle the radar on, if currently off, or off, if currently on. When the radar jammer is active, a green light illuminates next to the "R" warning indicator.

## DROP CHAFF

Press the *Drop Chaff* (m) key to release a chaff decoy.

## IR JAMMER ON/OFF

Press the *IR Jammer On/Off* (.) key to toggle the IR on, if currently off, or off, if currently on. When the IR jammer is active, a green light illuminates next to the "I" warning indicator.

## DROP FLARE

Press the *Drop Flare* (/) key to release a flare decoy.

## SELECT WEAPON

Press *Selector #2* to change the active weapon; the active weapon, along with the available quantity, is shown in the Weapons Indicator.

## FIRE WEAPON

Press *Selector #1* to fire the active weapon. Most weapons are fired/launched singly; each time *Selector #1* is pressed, one round is fired. However, rockets are fired in salvos and cannons & machine-guns fire in multiple-round bursts.



84870	47758
67372	43311
81987	76273
97662	91186
57925	37345



---

## HELICOPTER GAUGES AND INDICATORS

This gauge, along with its digital readout, shows your horizontal speed through the air in knots. A speed of 100 kts equals about 114 mph, or about 161 kph.

This gauge, along with its digital readout, is your barometric altimeter; it shows your true altitude in feet. It's adjusted for you to compensate for ground elevation variances so that "0" altitude is always at ground level.

This ball gauge shows your pitch (nose up or down) and your roll (left or right).

The "P" illuminates whenever the autopilot is engaged.

The "H" illuminates whenever auto-hover is engaged.

The analog compass, along with its digital readout, indicates your current heading. Note that the compass shows the heading your helicopter faces. During skids or backwards flight, your actual course is different.

This indicator shows the number of defensive stores remaining. Its shown as chaff "CF" and flares "FL". Each defensive unit is released as a group of three cartridges.

The left and right strips in the gauge marked "E" show the RPM's of the port (left) and starboard (right) engines.

The gauge marked "F" shows the amount of fuel remaining in all tanks.

The HUD (head-up display) projects bright numbers and symbols ahead of your view so that you can simultaneously read the display and look ahead.

The left scale indicates your airspeed along with a symbolic representation of the artificial horizon.

The right side scale combines the radar altimeter with the vertical speed indicator (see below). The radar altimeter is probably the most important indicator you have, so pay close attention to it. It indicates your actual height over ground. There's an important distinction between this and the standard altimeter. As you fly over obstacles your true altitude remains constant, but the height over ground changes. This can be the difference between crashing or

## AH-64A/B APACHE

### AIRSPEED GAUGE

### ARTIFICIAL HORIZON

### AUTOPILOT

### AUTO-HOVER

### COMPASS

### CHAFF AND FLARE INDICATOR

### ENGINE GAUGE

### FUEL GAUGE

### HUD

15054	86691
85924	73924
49758	60276
66391	61939
97662	69768



surviving. The red band at the lower end of the scale is low limit.

The top scale is your heading along with the INS and target lock-on pips.

## INS INDICATOR

The INS (Inertial Navigation System) indicator indicates your course to your current waypoint. The top fixed pip is your heading, while the bottom pip is the waypoint. If it's right of center, turn to the right; if it's left of center, turn to the left. The waypoint course is also indicated digitally.

## MFD

The MFD has five possible displays: navigation (heading & waypoint data), low scale map, mission orders, weapon status or target camera.

## ROTOR LIGHT

The light is green when the main rotor is engaged. The light is red when the main rotor is disengaged, i.e. spinning freely, unconnected to the engines.

## SYSTEMS STATUS LIGHTS

These lights show the status of major systems on board your helicopter. A green light means the system is functioning normally; a yellow means the system is damaged and malfunctioning; a red light means the system is knocked-out and off-line.

The abbreviations represent:

AVN: Avionics (gauges, defensive measures)  
CAN: integral cannon  
FUL: fuel tanks  
OPT: optics (targeting systems)  
PTE: port engine  
PTW: port weapons wing  
RTR: Main Rotor  
SBE: starboard engine  
SBW: starboard weapons wing  
TAL: tail rotor (flight stability)

## THREAT DISPLAY

This screen shows nearby targets that can potentially threaten your helicopter. Red dots are opposing units, grey dots are non-threatening units or structures, blue dots are enemy aircraft, and yellow dots are missiles in flight. This includes both opposing missiles AND your missiles. The white flashing dot is your present target.

The threat display automatically scales from short to long range (short range will override long range).

## AH-64A/B Apache Cockpit Screen

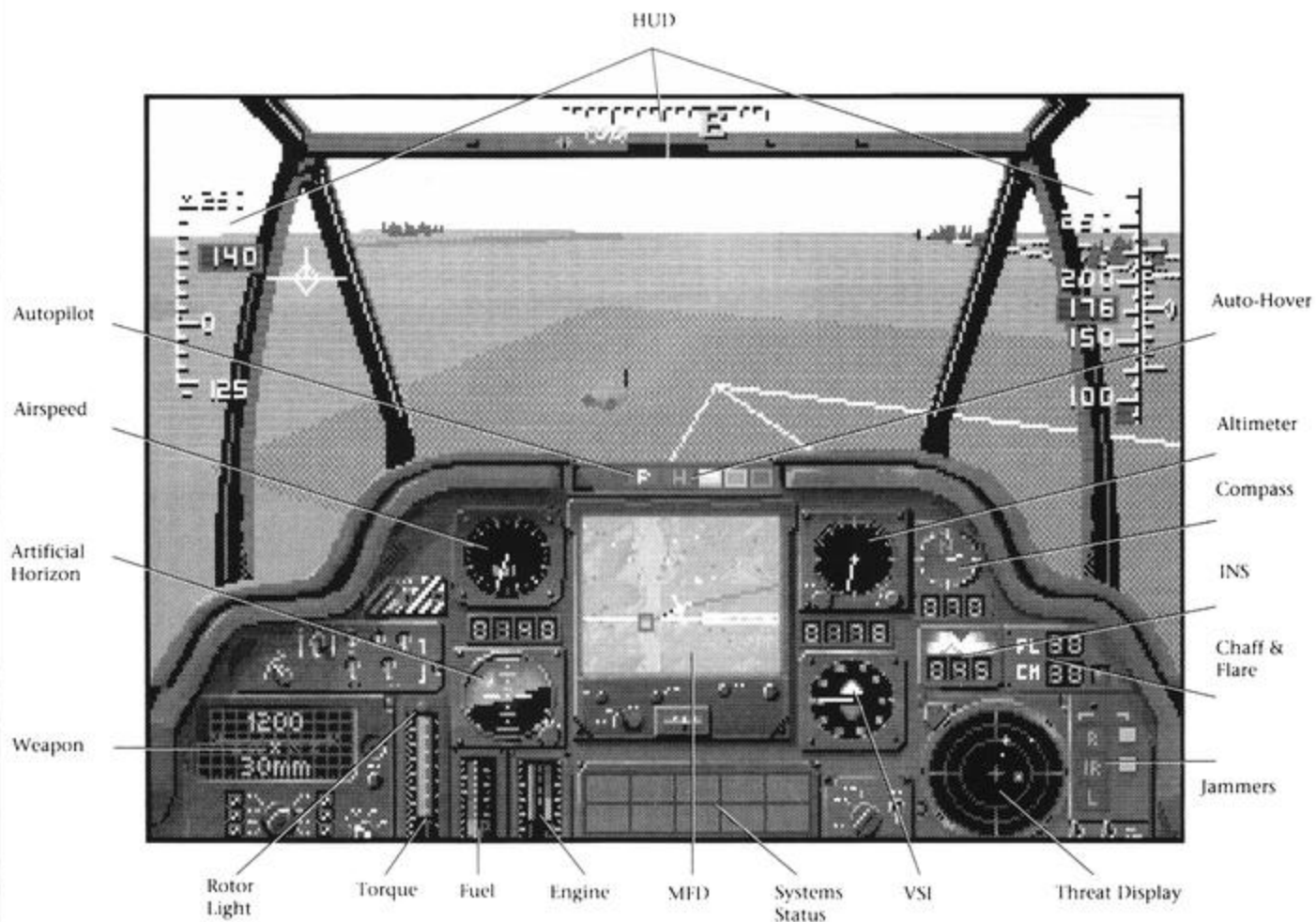

## TORQUE GAUGE

The strip shows the amount of torque in the turbine engine(s). This is proportional to the amount of collective control and rotor lift. The higher you set the collective, the higher the torque.

## VSI

The VSI (vertical speed indicator) shows the rate you are changing altitude (ascending or descending). If the needle is horizontal, you're maintaining a constant altitude. If the needle dips downward, you're descending towards the ground; if it points upward, you're ascending. The greater the needle varies from horizontal, the greater the altitude change.

## WARNING INDICATORS AND JAMMERS

The "R" warning light flashes red whenever a search radar "sweeps" over your helicopter. When tracking (firing) radar for either guns or missiles locks onto your helicopter, the light turns solid red. If you turn on your radar jammer, the neighboring light turns green while the jammer is running. If the jamming is successful, the solid red warning light turns off.

Note: your jammer can't suppress radar searches, so flashing red warnings may continue even if your jammer is active. If you leave the jammer active they'll eventually "read" your frequency and overcome the jamming.

The "I" warning light turns solid red whenever an infrared (IR) homing weapon is approaching your helicopter. If you turn on your IR jammer, the neighboring light turns green while the jammer is running. If the jamming is successful, the solid red warning light turns off.

While the radar jammer can remain on, the IR jammer eventually "times out" due to heat. It must cool down to again become effective.

Note: there aren't any active IR search devices, IR search is passive, therefore there's no flashing red "IR" warning.

The "L" warning light turns solid red whenever your helicopter is being illuminated by a laser ranging or targeting device. At the present time, laser jammers are still on the drawing boards. So, find the source and get it before it gets you or get out of Dodge quick.

## WEAPONS INDICATOR

The weapons indicator shows the active weapon, its position on the helicopter, and quantity of rounds remaining. For rockets, it also indicates the current salvo setting.

---

The Comanche cockpit is dominated by electronic systems, and aptly fits the trend towards total digital display. The first thing you notice is the lack of analog indicators (except for the compass).

The airspeed (ASI) and altimeter (ALT) data are both digitally represented. Next to the altimeter is the VSI icon; it indicates ascending, descending and neutral altitude change modes.

The status retractable landing gear is indicated by the gear (“G”) light; it’s illuminated when it’s down. You can fly with the gear in the down position, but speed is reduced and the radar cross-section is increased. Landings are impossible with the gear in the up position.

The status of the weapons bay is indicated by the bay (“B”) light; it’s illuminated when the bay is open. Internal weapons, except for the 20mm cannon, can’t fire when the bay is closed. However, when open, it increases the radar cross-section.

The remaining indicators, displays and HUD function in a similar manner to the Apaches.

---

Although their cockpit layouts differ from the Apaches, the gauges, indicators and HUD in the other helicopters function exactly like the Apaches. Just familiarize yourself with the unique layouts; the “look” of the gauges and indicators has been standardized for ease of use.

## AH-66A COMANCHE

### AIRSPEED AND ALTMETER

### GEAR

### BAY

### OTHER DISPLAYS

---

## THE REMAINING HELICOPTERS

59925	51058
57925	30823
60267	38076
49758	67909
81987	07341



## AH-66A Comanche Cockpit Screen

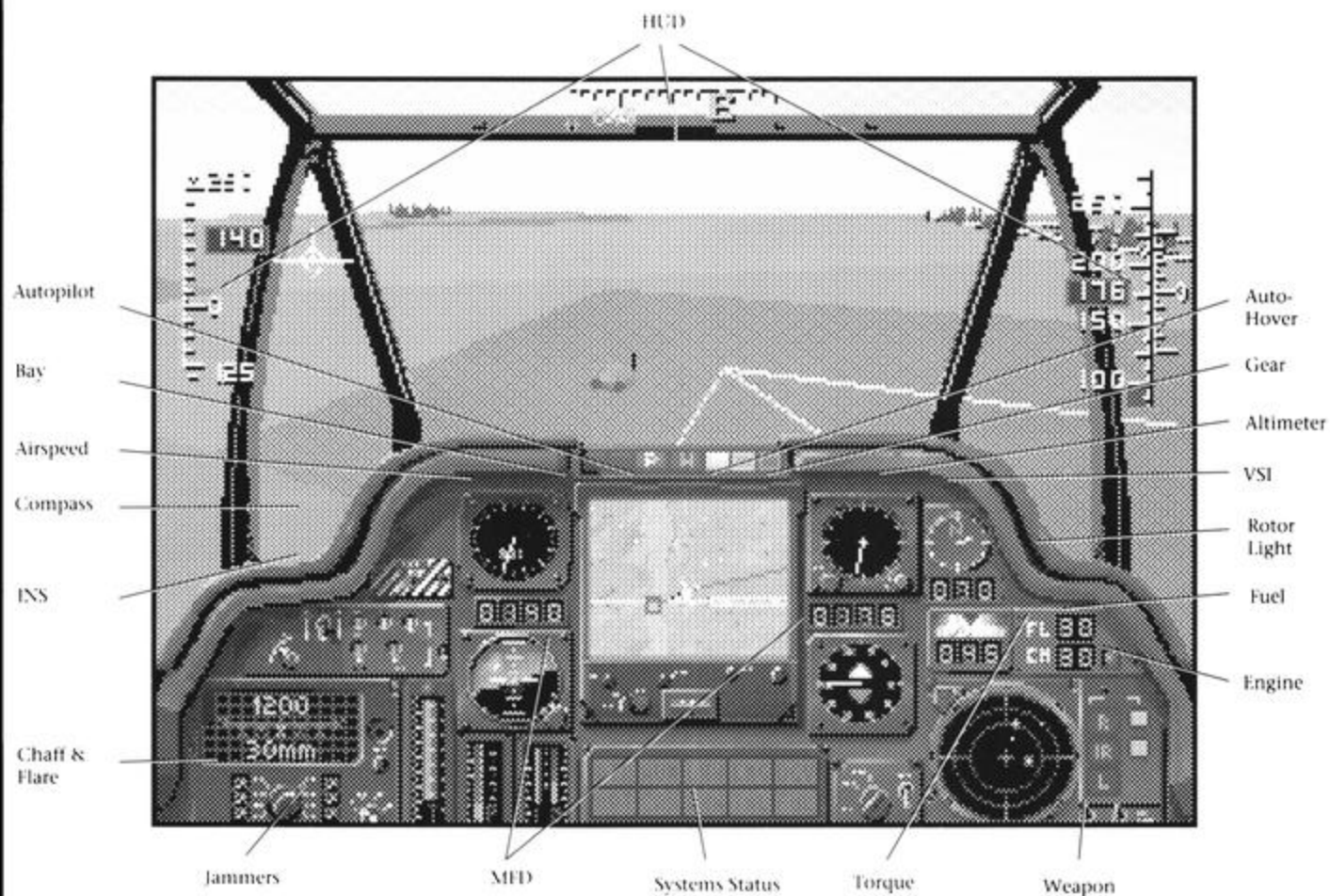

34620	62968
15054	13293
57925	76024
85924	14616
67372	26707

## HOW TO FLY

Helicopters are very complex flying machines. One wonders how a machine so angular and ungraceful could ever get off the ground. In flight, they look like a mass of whirling blades. Yet, helicopters do fly - and fly well for that matter; but, the controls are quite different from a conventional airplane.

It's often said that the real pilots fly helicopters; the other guys just dabble at flying.

Remember just one thing - **DON'T OVERCONTROL!** Helicopter controls are sluggish; they react slowly. Even the most responsive helicopter (like the Comanche) takes a couple of seconds to respond to your control movements.

Be gentle with the controls. After each control movement, watch for the result before you do anything else. Numerous fast, radical control movements produce unexplainable results and possibly a crash!

The most common error in helicopter flight is to over-control by pulling or pushing hard on the cyclic or pressing too long on a key.

The emphasis is on realistic flight, since that's the most complex. If possible, learn to fly in the realistic mode from the beginning; you can always fall back on the easy mode if the frustration factor gets too high.

## GETTING AIRBORNE

### ENGAGE THE ROTOR

Your power is already on line; the APU provided the power to start the engines. Press the *Rotor Engage/Disengage* (9) key to engage the rotor system. The rotor status light turns green when the rotor is engaged. The rotors now come up to speed (the sound level increases).

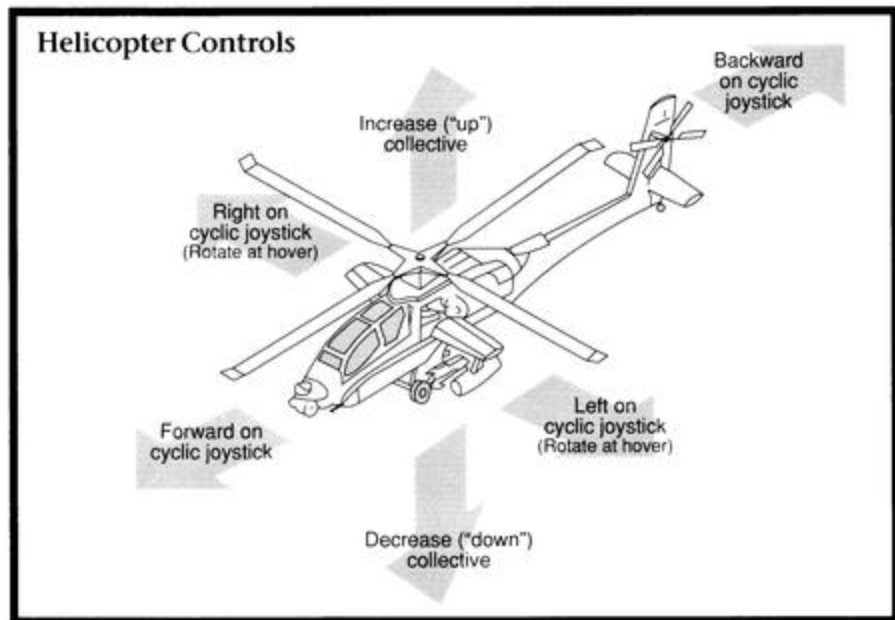

97662	09708
34620	69490
59925	54241
15054	05662
84870	84952



## CLIMB TO A HOVER

Press the *Collective Up Fast* (shift =) key until the helicopter starts to ascend. The torque gauge rises as you “raise” the collective. Press the *Collective Down (-)* key if the ascent is too fast. The VSI indicates the rate of your ascent (the indicator is above horizontal). Let the helicopter ascend to about 100 feet.

Press the *Auto-Hover (0)* key anytime your speed is from +10 to -10 knots. It’s very useful to maintain a position during windy conditions or to unmask and quickly mask from cover.

## ROTATING IN HOVER

Push the *Cyclic* (left or right arrow keys) left or right to rotate the helicopter in that direction. The speed of rotation is dependent on how far the *Cyclic* is pushed (multiple presses of the arrow key). Center the *Cyclic* (press the opposite arrow key until rotation stops) to stop the rotation. You can only rotate the helicopter at speeds under 10 kts.

---

## FLIGHT TECHNIQUES

### FORWARD FLIGHT

Add a little more collective. As you begin climbing, push the *Cyclic* forward slightly to “pitch down” the helicopter. You’ll begin to move forward. At about 30 kts, you’ll start to climb. Your altimeter and VSI reflect this change in lift. This is because forward motion in a helicopter adds extra lift (termed “translational lift”), especially at 30-90 kts.

The further you pitch down, the more your speed increases. As your speed exceeds 100 kts, translational lift decreases. The VSI starts to move to the negative end of the scale. More pitch downward will push you into a dive.

**Easy Flight:** Lift is unaffected by forward motion. Your altitude remains constant, and is therefore independent of the cyclic.

### LEVEL FLIGHT

Move the *Cyclic* forward or back until the airspeed reads about 120 kts. Now check the VSI. If you’re descending (the indicator is below horizontal), add more *Collective* until the indicator is horizontal. Alternately, if you’re ascending, reduce *Collective*. When the VSI is horizontal, you’re in level flight.

Due to the slow control response, it’s easy to over-correct and add or reduce the collective too much. You’ll constantly “chase the needle”, trying to stabilize your flight. After each adjustment, wait a moment for the VSI to stabilize.

**Easy Flight:** These adjustments are unnecessary since lift is unaffected by forward motion.



63288	09762
78957	55801
56824	37791
66391	16234
81987	54867



## CHANGING ALTITUDE

When flying level (about 120 kts), the easiest way to descend is to push the *Cyclic* forward (pitch down) into a dive. As you approach the altitude desired, gently pull the *Cyclic* back (pitch up) until the VSI again stabilizes. Similarly, the easiest way to ascend is to pitch up slightly, reducing airspeed below 100 kts. When you reach the desired altitude, pitch down again until the VSI stabilizes. This technique is not unlike conventional airplane flight. You're able to change altitude without adjusting the collective.

A second way to change altitude, applicable at any speed, is to raise or lower the collective. When you reach the desired altitude, adjust an opposite amount of collective to regain level flight. This is the only way to change altitude from a hover.

Regardless of the technique used, don't try to fly the helicopter by constantly adjusting the collective. Learn to "feel" the correct collective setting, and then fly with just your cyclic. This takes time, so be patient. Even real pilots must practice many long hours before it's mastered.

**Easy Flight:** The collective must be used to change your altitude; it's just like choosing the floors on an elevator.

The low altitude limit is a flying aid that warns you of close ground proximity. It works in conjunction with the radar altimeter, and is displayed as a red band on the radar altimeter.

From a level flight (about 120 kts), move the *Cyclic* slightly to the left. Your helicopter rolls into a banking left turn. As you turn, observe the change in your compass heading. Move the *Cyclic* further left and bank into a tight turn; you'll now start to lose lift. Notice that your altitude is dropping and the VSI is below horizontal. If you center the *Cyclic* and level out, you'll return to level flight.

There are two methods to maintain altitude in a tight turn; this could be very important at low altitudes. Add some *Collective* before you start the turn, then reduce the *Collective* just before you come out of it.

Alternately, pull up your nose slightly as you enter the turn, then drop it back down as you come out of the turn. With this method, you can make fast, banking turns without losing altitude.

## LOW LIMIT

## TURNING

78957	12211
66391	51322
26911	68983
49758	85567
67372	64023



At speeds below 40 kts, the helicopter will skid (“sideslip”) in the direction of cyclic movement, rather than bank into the turn; at this point, you’re basically flying sideways.

**Easy Flight:** Altitude is never lost, no matter how tight the turn. However, the helicopter will sideslip at speeds below 40 kts.

## TURBULENCE

When flying below 100’, you may feel air turbulence. You’ll sometimes bounce up and down, or roll from side to side. The amount of air turbulence varies with altitude and speed; the faster and lower you fly, the more turbulence you may experience.

## AUTOROTATION

Helicopter crewman can’t eject or bailout in times of trouble. However, the total loss of engine power means only one thing - they must ride the bucking bronco in.

Fortunately, helicopters have the equivalent of an conventional airplane’s “dead stick” landing. This unpowered method of landing is called “autorotation”.

To begin an autorotation, disengage the rotor. In real life the pilot must also “bottom” the collective (reduce it to zero), but the collective automatically bottoms when you disengage the rotor. This must be done immediately, or the rotor will slow to a stop (remember it’s still engaged to the now-dead engines). If the rotor stops, you’ll fall like a baby grand piano.

Now adjust the pitch until your airspeed is about 70 to 90 kts (maximum translational lift). The rotor is now spinning freely because the airflow keeps the blades turning. The descent will become quite fast, a bit frightening to the inexperienced. When you get close to the ground, raise the nose and simultaneously add *Collective*. The rotor blades will “bite” into the air, giving you lift and slowing the descent. Unfortunately, as the blades start to bite, air resistance slows them down.

You must time the “up collective” so that the helicopter lands gently (figuratively speaking) before the rotor slows too much. If you raise the collective too soon, the rotor will stall and you’ll be playing the piano again. If you raise the collective too late, you won’t slow your descent and you’ll crash. Nobody said it would be easy - it just takes practice.

**Easy Flight:** Autorotation is not functional with easy flight. It’s best to set “no crashes” when in this mode.

## FLIGHT ENVELOPE

There are “unsafe” speed and altitude situations that, in the event of total engine failure, will unavoidably result in a crash. These unsafe situations are considered to be outside of the “flight envelope”.

Hovering at altitudes from 25’ to 500’, or high speed flight below 20’ to 30’ will probably result in a crash if engine power is lost. It takes a certain amount of time to convert from normal flight to autorotation. In these situations, there just isn’t enough time to gain control.

However, “unsafe” is a relative term. In combat situations unsafe flying is probably “safer” than taking a hit. During combat, chances must be taken; evaluate the situation and make the best decision.

Everyone has rules they must abide by, and this is no different in combat. Helicopters live and fight near ground level, as high altitude is only safe for the jet jockeys.

The high command wants to assure that you will have a long and distinguished career. Therefore, your maximum altitude is restricted to 1000’ in all situations. Any higher, and you’d be a sitting duck.

## RULES OF ENGAGEMENT

Pressing the *Map View* (F10) key displays the high scale mission map. You can always fly to specific points by dead reckoning or, more simply, you may input up to three waypoints into the INS system.

To input waypoints, press the *Fly To* (F) key; a yellow crosshair appears over your helicopter. Use the *Controller* to move the crosshair to any point on the map, and press *Selector #1*; waypoint #1 is now marked. Press *Selector #2* to stop with less than three waypoints or continue to mark waypoints #2 and #3. Press *esc*, at any time, to cancel the waypoints. Existing waypoints are automatically cancelled whenever the *Fly To* (F) key is pressed (*esc* will cancel the command).

Because the high scale map is only a representation of the actual terrain, you may want to “fine-tune” the placement of the waypoints. After all, you wouldn’t want to fly into a mountain. Press the spacebar; the low scale map appears. Use the *Controller* to follow the path of the waypoints (each waypoint is marked with its number). To adjust a waypoint, press its number. It’s now centered in the map display. Use the *Controller* to adjust its placement; press *Selector #2* when finished.

## NAVIGATION INS SYSTEM

56824	01287
26911	18484
94144	50173
85924	43942
84870	43260



The current INS heading is the flight path to the “active” waypoint. The waypoint range and heading can be displayed in the MFD. The *Next Waypoint* (6) and *Previous Waypoint* (7) keys are used to change the active waypoint. To manually adjust your course, always turn towards the INS pip.

Press the *Autopilot* (5) key at anytime to engage the autopilot. When engaged, it flies you to the “active” INS waypoint.

## WIND AND WEATHER

When flying during windy conditions, the same considerations that apply to an airplane apply to helicopters. Namely, the wind will increase your speed, slow you down, and/or push you sideways, depending on your flight path in relation to the wind velocity and direction. This is most noticeable on long distance flights.

Temperature also affects helicopter flight. As air gets warmer, it expands and becomes thinner, providing less lift. If the air gets too cold, icing on the rotor becomes a problem. Similarly, in humid conditions the air is composed of more water, reducing lift. Finally, as altitude above sea level increases, air gets thinner, reducing lift. For helicopters, ideal flying conditions are 70° F (21° C) on a dry day at sea level.

---

## LANDING

The nice thing about helicopters is their ability to land without a paved airstrip. However, they can't land on sloping ground. Any slope greater than 5° causes so much rotor tilt that the helicopter flies, or skids away from the slope, making a landing impossible. NEVER try to land on a hillside - you'll crash!

Ideally, all landings, and takeoffs for that matter, should be into the wind. As you approach the base, lower your altitude to about 50' and reduce your airspeed to 60 kts by pulling back slightly on the *Cyclic*. You'll need to reduce the *Collective* to maintain your 50' altitude. Your goal is to land in the center of the base. Just before you cross the outside edge of the base, begin slowing down to a hover by pulling back on the *Cyclic*. Note that as your speed drops towards 0 your lift will decrease. Add some *Collective* to maintain your altitude.

The wind will tend to push you away from your present position; the *Cyclic* should be moved slightly toward the wind, producing just enough skid to counteract the wind velocity. This will maintain hover against the wind.

Reduce the *Collective* (easy does it here) to begin your final descent. At about 20' you may need to reduce the *Collective* further to achieve touchdown.

**Easy Flight:** The collective must be used to change your altitude; however, altitude is unaffected by the cyclic controls.

Forward arming and refueling points (FARP) are highly mobile bases designed to support helicopter operations. They are placed near or around the battle area, and are usually set up to support a particular squadron or mission. They are well stocked with aviation fuel and a full range of weapons.

## FARPS

Your mission orders indicate if a FARP is available for the current mission. If available, you may land at the FARP just like any other base. The ground crew immediately refuels and rearms your helicopter and your flight.

Unfortunately, they're not supermarkets - there's no shopping allowed. Your helicopters are refueled and rearmed to match your start of mission configurations.

You may ask what business the Army has at sea? As a member of a highly trained, elite force, you are more than up to the task. Still, carrier based landings are a little more complicated than your everyday open-field variety.

## CARRIER LANDINGS

The landing pad is smaller, and the carrier deck isn't at 0' altitude. The radar altimeter is the key instrumentation; it indicates the proper approach altitude as you center your position over the deck. The other steps are just like landing on the ground, but be prepared to immediately max the collective if you've misjudged your approach.

When you have landed at your base (altitude is 0), disengage the rotor. Your postflight options now appear.

## SHUT DOWN

---

## HOW TO FIGHT

Helicopter combat systems have come a long way since the days of door mounted machine-guns and "wing and a prayer" defensive measures. Contemporary helicopters possess an extensive array of weapon and defensive systems. Each has been tailored to a specific target type or purpose. It's important to become familiar with each system's strengths and weaknesses. It'll be the difference between getting the target or the target getting you!

---

## FLIGHT PLAN

Before you takeoff, re-examine the mission map, and decide on a flight path that will take you to the primary or secondary. Remember, the most obvious route may end up being the most disastrous. Bounding directly into the target at 140 kts and 500' of altitude may work in training, but it's suicide against well-equipped troops.

A standard technique is to fly to the target in short dashes. Fly from behind one hill to another, then hover and pop up briefly to scan ahead. Drop down, pick your next destination and repeat the process. Stay as low as possible when dashing, and use intervening terrain to mask your movement. It may sound boring, but you'll enjoy the results.

Fuel is a major consideration; it isn't unlimited. Don't stretch yourself to the point you can't make it back. This is especially important when flying over water.

Any success quickly turns to failure if you loose your flight to poor fuel planning. Always know the position of your base and FARP. Don't hesitate to "top off" your tanks if there's any question.

---

## THREATS



66391	06246
49758	17019
85924	97132
15054	32692
63288	35923

As you fly, watch the threat display; the top of the display coincides with your current heading. A red dot is an opposing ground unit. A blue dot means an opposing aircraft is approaching. A yellow dot indicates a missile in flight. Note that the threat display can't distinguish between friendly and opposing missiles. A grey dot is a friendly unit or a neutral structure.

When units appear on your threat display, they are also plotted on the maps. They appear darker when they disappear from your threat display; that's their last known position.

Though virtually every opposing unit has some sort of gun or shoulder-launched missile, the most dangerous are AA guns and vehicles and SAM vehicles.

Watch your warning indicators; they are the true measure of enemy activity. The "I", "R" and "L" indicators turn or flash red to indicate opposing search or tracking activity. Additionally, the originating unit's dot on the threat display automatically changes to a cross, thereby alerting you to the bearing of the most dangerous threat or threats.

When a warning indicator illuminates, the standard response is to turn on the corresponding jammer; press the *Radar Jammer* (n) key or *IR Jammer* (.) key ("L" jammers currently aren't available). A small green light beside the warning light illuminates, showing your jammer is active. If the warning indicator turns off, the jamming was successful. Immediately turn onto a new course, as jammed missiles often continue on their old course.

Keep your jammer active until you destroy or fly away from the threat. It's a good idea to immediately activate both jammers if the threat concentration is high.

If the warning indicator remains illuminated, try using a decoy; press the *Chaff* (m) key or *Flare* (/) key to launch a decoy. The decoy indicator illuminates as long as the decoy is active. The decoy should be drawing the missile or gunnery to its position.

---

For a general description of helicopter tactics, see pages 110 - 112.

Ground based weapons utilize active radar, passive IR or optical means to search out and find targets.

Search radars can "see" you at long distances in day or night. A distant red dot on the threat display is probably a search radar. Since the purpose of search radars is to detect your presence, jammers and decoys are counter-productive, as both announce your presence!

Other units use short-range passive IR or the old standby - eyesight. They can't see you until you're much closer, and at night optical sighting is especially limited.

## WARNING INDICATORS

## JAMMERS

## DECOYS

## ON THE DEFENSIVE

### HOW THEY FIND YOU

## HOW THEY TRACK YOU

All methods of search are blocked by objects on the ground. As a result, ground-based units have a “dead-zone” they can’t see. Above this dead-zone the “eyes” will eventually find you. This dead zone becomes smaller and lower as you approach the unit.

If a search is successful, they switch to “tracking” mode. If employing radar, they constantly illuminate you with a radar beam. This sets off your radar warning and causes the indicator to solidly illuminate.

When launched, IR weapons set off your IR warning and cause the indicator to solidly illuminate.

If a laser ranger/designator is “painting” your helicopter, the laser warning goes off and causes the indicator to solidly illuminate.

If you’re being tracked by radar or an IR weapon, use your jammers and decoys. If that fails try evasive flying.

Dive to a lower altitude while turning parallel to or away from the threat. If you get lower and avoid closing the range (the dead-zone effect), an enemy often loses its track. Evasive flying is a superior option to jammers and decoys, because it doesn’t broadcast your position.

Laser guided and visually aimed weapons can’t be jammed or decoyed, so evasive flying is your only defense.

## SURVIVING TRIPLE-A

If they find you, opposing guns will open fire and continue to fire until they shoot you down. You must either break the track or destroy the weapon. It’s that simple. If the gunfire is radar controlled, you can probably break the track with jamming or chaff. However, all guns have optical backup systems (some have laser systems).

The best way to survive gunfire is skillful evasive flying and dead-eye firepower.

## SURVIVING SAMS

If they find you, SAM equipped units will launch a missile. Missiles are either IR-guided, radar-guided or visually-guided. When a missile is in flight, you’ll see a yellow dot moving towards you on the threat display.

Passive IR-guided missiles are the most common threat. Your IR warning indicator illuminates when they approach. Use your jammer or flares to “confuse” the missile, but remember to turn away so as not to collide with it.



Sophisticated IR missiles probably have visual or laser back up guidance; don't get too elated if you defeat the IR-guidance, there may still be a nasty surprise in store.

While radar-guided missiles are primarily designed for use against conventional jet aircraft, they still pose a serious threat. A radar beam reflecting off your helicopter guides the missile. This radar beam is what illuminates your radar warning indicator. Use your jammer or chaff to "confuse" the missile, but remember to turn away so as not to collide with it. Just like IR-guided missiles, radar homers probably have back up guidance systems. Therefore, defeating the radar is just the first step in defeating the missile.

Visually or laser-guided missiles are the greatest threats. You have no effective jammer or decoy defenses; your only bet is evasive flying. Putting terrain between you and the missile is the best bet. Flying into the dead zone is the only other hope. Remember, successful evasive flying requires that you fly lower AND away from the launcher. If you continue flying towards the launcher, flying lower may not be effective.

After all this, there is some good news. All missiles have one universal weak point - they have a wide turning radius. If you can get one close, dart off perpendicular to its flight path; it will be unable to turn fast enough to hit you. This tactic is easier said than done in a slow moving helicopter (fast-movers swear by this manoeuvre). It takes enormous skill, and split second timing to turn inside of a missile screaming in at Mach 3.

The Appendix includes a summary of the various AAA and SAM systems that await your pleasure. A description of the search, tracking and missile guidance systems is listed, along with an estimate of their effectiveness.

Study your mission intelligence briefings closely. If necessary, reference the weapon system to understand its use and effectiveness.

When out over the water, you have lost the best means of defense - terrain. You'll need to stay extremely alert, since the opposing patrol craft carry a number of defense weapons. Stay low or carry long range weapons, such as Penguin and Maverick.

**OUT AT SEA**

---

## DAMAGE

If you're unable to "spoof" the threat, the gunfire or missile will probably hit your helicopter. You'll see the explosion and the shudder of your helicopter. If the hit was severe, one or more of the system's status lights will illuminate. Systems will start to malfunction or fail. You'll need to evaluate the damage to determine if you can continue the mission or need to return to base.

If you are hit in multiple or critical systems, your helicopter will lose power. The only way to survive this is to autorotate to a safe landing. The number of hits required for a general systems failure varies; after three or four, you should expect the worst.

---

## HELICOPTER WEAPONS TARGETING

Your on-board targeting system is constantly scanning the forward arc; the system is limited to the front 180°. It can't scan to the rear, so pay close attention to your flight path, and occasionally swing around to check your "six".

The targeting system is line-of-sight dependent. As a result, the higher you are, the farther it can "see". Of course, the higher you are, the easier it is for the other guys to spot you.

The targeting system automatically "locks" onto the closest target. A diamond appears in your forward view, and an image of the target, along with its range and heading data, displays in your MFD. You may switch the target lock, assuming others are in the area, by pressing *Selector #2*. There may be a momentary delay; the targeting system must re-scan the entire area for new targets.

When the locked target is within maximum range for the selected weapon, the target box becomes a solid. This range varies from weapon system to weapon system, as maximum ranges differ. If you fire at a target before the target box changes, there's no chance of a hit!

## MAST-MOUNTED SIGHTS

The AH-64B Longbow Apache, OH-58D Kiowa Warrior and the AH-6 Defender are equipped with a sighting system mounted on top of the main rotor hub. This system enables these helicopters to "see" at greater ranges. Better yet, they may peer over the top of intervening terrain without exposing the helicopter. Press the Mast View (F2) key to switch to mast view; use the Controller to rotate your view.

## FIRING

Depending on the weapon selected, a reticle ring or a fixed crosshair appears in your view. The reticle ring works with “guided” weapons, whereas the crosshair works with “unguided” weapons.

The reticle ring must be superimposed over the target diamond to accurately engage the target; adjust your flight path if necessary. It has a range of movement that represents the angle of offset for the selected weapon. The reticle ring also becomes larger as the range drops, indicating the “confidence” of the shot.

The crosshair is always positioned directly ahead. Unguided weapons always fly or fire as you bear. Adjust your flight path to coincide with the target box. There’s no question it’s a challenge to fire unguided weapons at long range. Aiming errors, no matter how slight, normally result in a miss.

Pressing *Selector #1* fires the “active” weapon. Cannons and machine-guns fire in 20 round bursts. Rockets fire in salvos of 1, 2 or 4. All other weapons fire singly.

The weapon indicator displays the “active” weapon, its position and rounds remaining; rockets also indicate the current salvo setting. Press the spacebar to change the active weapon.

All rockets, both gun pods and the AH-6 Defender’s integral gun are unguided weapons; the remaining weapons are all guided.

Certain weapons are only effective against certain target types. The Appendix includes a summary of the weapon systems, including characteristics and effectiveness. Familiarize yourself with these systems. There’s nothing worse than blazing away at a target, wasting round after round, only to discover that you’re using the wrong weapon.

When you fire a cannon or a guided missile, the helicopter bucks and recoils upward; some altitude will be gained due to the loss in forward motion.

**Note:** this effect isn’t experienced in easy flight mode.

## WEAPONS

## PRIMARIES AND SECONDARIES

If a locked target is part of the primary or secondary mission, a prompt appears in the MFD along with the other target data.

## THE CP/G

Your invisible co-pilot/gunner (the front seater - back seater if you're flying the AH-66A Comanche) assists you in two ways during the course of a mission. First, by communicating important system status and threat/target information; and second, by assuming control of part of the weapon systems functions. The degree of weapon system control is dependent upon the CP/G reality switch setting.

---

## ON THE OFFENSIVE

The best thing about helicopters is their ability to approach targets undetected; they literally live (from a survival standpoint) at nap-of-the-earth (NOE) altitude - about 100'. They move in and out of the terrain like a jungle cat stalking its prey.

Sneak up on suspected targets, and use caution. Take a few extra minutes to evaluate the situation. The pilot that plunges headlong into a combat situation will more than likely retreat just as quickly with his tail between his legs. Leave the flamboyant entries to the jet jockeys - they need more attention, anyway!

If possible, attack from the flank rather than the front; this is referred to as an enfilade attack. You can engage targets in turn, while limiting the number that can spot you. If you engage from the front, all of the targets can spot you simultaneously.

Use long range engagements; the further you stay away, the better. Most of your weapons are longer-ranged than the opposition's - take advantage of it.

If you only remember one thing, NEVER overfly the target. If you didn't destroy the target, you're giving away a free shot at your tail.

First and foremost, choose the right tool for the job. Evaluate your mission orders carefully and outfit your helicopters with the most advantageous mix of weapons. For example, if you're ordered to intercept enemy shipping, you may want to take a few Penguins or Mavericks along for the ride.

Once in combat, make sure that the “active” weapon is the most effective choice. Don't try to fire Sidewinders at tanks or TOWs at aircraft.

**Cannons:** are close range weapons that are best fired straight ahead. Deflection shots to the sides will consume more ammunition and reduce your chance of a hit. The Apache A&B's 30mm cannons and the SuperCobra's and Comanche's 20mm cannons are essentially guided weapons - they're aimed by your targeting system. The defender's machine-gun and pod guns must fire straight ahead.

**Machine-guns:** are very close range weapons, and can only be fired straight ahead. They lack the penetrative power of cannons, and therefore are only effective against unarmored targets.

**Rockets:** are available in three types. Each is best suited for a particular type of target, but can be effective against other target types. They're unguided weapons, and are therefore easier to fire at close range. However, they can be fired in salvos, and you can carry a fair number.

**ATGMs:** are also available in three types. They're powerful anti-armor weapons that can be effectively utilized against structures, ships and even slow moving aircraft.

**TOW** is a wire-guided weapon that's steered to the target. It's not as difficult as it may seem. As long as the target is locked, corrections to the missile's flight path are automatically calculated and transmitted to the TOW over the unspooling wire. However, the wire is the biggest limitation - it runs out at about 3,800 meters.

**HellFire-A** is a laser designated weapon that homes in on reflected laser light. It's much longer ranged than the TOW and has a wider target envelope. Since the Hellfire “sees” the reflected light, the designation can be switched to a different target; if it's within the target envelope, the Hellfire will hit the new target. This allows for “ripple fire” tactics. Multiple missiles are fired at short intervals; after the first hits, the designator “spots” the new target, and then guides the second missile.

**Lasers** are not as effective during low visibility conditions. Rain, fog and snow can reflect some or all of the laser light limiting range and hit probabilities. There's another disadvantage; if you're designating your own target, you must also expose the helicopter until the Hellfire hits the target.

**Hellfire-B** is the latest version of this effective weapon system. It's the primary armament on Longbow Apaches; it can't be carried on Model-A Apaches. It replaces the laser homer with a fire-and-forget millimeter wave radar homer. All you do is find the target, and fire the missile - it doesn't get any easier. This combined with the Longbow's mast mounted sight makes for a potent, unbeatable combination.

**Sidearm:** is designed to home in on any surface radar emission source; therefore, it's classified as an "anti-radiation missile". Its big brothers, HARM, Standard and Shrike, have been utilized to great effect on conventional aircraft for years. Now, helicopters possess a similar punch. You don't have to get a target lock to fire a Sidearm; just make sure to fire it towards the radar source. It's fragmentation warhead and fire-and-forget technology make it one terrific "quick-draw" weapon - a surefire way to permanently cancel that radar.

**The Big Loads:** Maverick and Penguin are heavyweight special purpose weapons. Their use in helicopters is shrouded in controversy; some argue they're not worth their weight. The opponents feel that Hellfire is just as effective, and you can carry 4 Hellfires for every 1 Maverick or Penguin. On the other hand, Maverick and Penguin are both longer ranged than the Hellfire and are fire-and-forget weapons. The arrival of Hellfire-B makes the argument even hotter - the decision is yours.

## MASKING

Not what you'll wear to your next costume party, it's the method of terrain shielding often called the "pop up". It's also where the auto-hover pays for its weight. It automatically maintains your present position and altitude even in the face of a stiff wind.

Pull up behind a convenient hill position and drop your airspeed to 0; your altitude should be about 100' - 150'. As your airspeed approaches 8 -10 kts (it must be 10 kts or less), press the *Auto-Hover* (0) key; this immediately reduces your airspeed to 0.

Now press the *Collective Up* (=) key to start a slow ascent. As you clear the crest of the hill, stop your ascent. If your helicopter is equipped with a mast-mounted sight, stop the ascent just as the sight clears the hill. You're now in position to scan the surrounding area.

If you lock onto an important target engage it immediately, and then drop down below the crest; press the *Collective Down* (-) key. Otherwise, drop below the crest and re-evaluate the situation. If necessary, check the mission map. You may need to adjust your flight path, or unmask again to engage the other targets.

As an alternative approach, rotate the helicopter left or right by moving the *Cyclic* left or right. Then push the *Cyclic* ahead slightly to add a few knots of airspeed. Try to keep your airspeed under 10 kts. As you clear the side of the hill, press the *Auto-Hover* (0) key, and rotate back to the forward area. After scanning the area or engaging the targets, reverse the process (with a little more haste this time), and duck back behind the hill. While this method of unmasking limits the scanning range, due to low altitude, it's an excellent method of engaging known targets - longer ranged targets probably won't spot you.

Remember with auto-hover active, you can quickly drop altitude by virtually bottoming the collective; it holds you at the low limit.

Your missions present a number of target options, each with unique characteristics requiring different tactics of engagement or weapon selection. Always look before you shoot; the high command gets real upset when you start shooting up the friendlies.

**AAA & SAMs:** are your biggest challenge. These are the only targets that can fire back with any real effect. Getting in the first shot is the key here. Both types have reaction times of 5 to 20 seconds, depending on the sophistication of equipment and the skill of the crew. If you plan your attack carefully, you can "take them out" before they even get a shot off.

## TARGETS

**Tanks & Light Vehicles:** can be a turkey shoot. Attack helicopters, especially the Apache, are made to destroy tanks and vehicles. The tanks don't carry anything larger than a short range 14.5mm machine-gun; you can pick them off easily. IFVs and APCs can be a bit nastier; they carry shoulder-launched SAMs. Most of the other vehicles, such as truck convoys, are totally unarmed.

This may seem too good to be true, but before you think it's a cakewalk, the opposition has also recognized these weaknesses. Groups of tanks and other vehicles normally travel with AAA & SAM vehicles. Keep an eye out for these escorts.

**Working on the Railroad:** doesn't get any easier than this. Railroad "rolling stock" isn't much of a challenge, but important none the less. You know where they are and where they must go; it's just a matter of laying in wait and taking them out of action.

**Naval Targets:** can get quite pesky, and the opposition has a habit of placing armed forces on their oil platforms. Guided weapons are a must in these situations. They are better suited to deal with the maneuverable patrol craft, and you need their punch to take out the oil platforms.

**Infantry:** are difficult to spot and root out. They're only armed with light weapons, but most also carry shoulder-launched SAMs. Rockets and cannon/machine-gun fire are a good choice in this case.

**Structures:** pose problems similar to infantry. Although bigger and easier to spot, they are seldom undefended. SAMs and all types of AAA guns are usually in the vicinity. If you pick off the defenders first, the structures are then fair game.

Bunkers and bridges are especially tough nuts to crack. It may take more than one hit to destroy them.



When helicopters were first envisioned as combat weapons, the importance of air-to-air combat was all but overlooked in the USA. Unfortunately, the Soviet planners were not so shortsighted.

The Soviets have always placed a strong emphasis on air-to-air combat, and have made concerted efforts to design this capability into their helicopters. Many in the US Intelligence community consider the new Ka-34 Hokum to be a purpose built “anti-helicopter” helicopter.

Fortunately, the US military planners are no longer ignoring this all too important technology. Air-to-air weapons have become a standard load when flying where air superiority is in doubt. The new AH-66A Comanche is designed with a high degree of air combat functionality; it’s closer in concept to high-performance jet aircraft than past helicopter designs.

In actual air-to-air combat, one facet that requires constant vigilance is a helicopter’s ability to spring from nowhere. It’s on you before you know what is happening, snaps off a missile and vanishes in the wink of an eye.

Helicopter borne air-to-air missiles are the primary threat. They come in all varieties of homers, and are usually more maneuverable than ground based weapons. The helicopters also carry machine-guns or cannons. Unit for unit, they can pack just as strong a punch as the friendlies.

In Chapter 3, Helicopter Tactics, a number of the tactical maneuvers key to air-to-air combat, are discussed and diagrammed, but it essentially boils down to a few specific factors:

**Altitude:** Stay low! Aircraft like nothing more than to find a helicopter flying up where only the eagles should dare. It’s bad enough exposing yourself to the ground fire, but it’s murder against aircraft.

**Take the First Shot:** If you can get the first shot in, you have the best chance of coming out on top. Pay attention to the threat display, and stay ready to snap off a quick shot.

## WEAPONS

**Range:** Fire at the longest range possible. This gives you a chance to reposition and take additional shots. Additionally, if they have ordnance in the air, it gives more time to counter or evade.

**Hold the Advantage:** Get on the aircraft's tail or keep it to your front. NEVER lose sight of the enemy! If they get on your tail, use a side flare or a horizontal scissors to reverse the advantage. If necessary, use the *Left View* (F3) key or *Right View* (F4) key to maintain visual contact.

There aren't as many decisions to make with air-to-air weapons. They are adaptations of existing weapon systems. To date, the first purpose built helicopter AAM is yet to be seen.

**Cannons:** is the choice for close quarters. The Apaches, SuperCobra and Comanche use their helmeted mounted sights to maintain lock-on during tight twists and turns. Fixed-firing cannons can still be effective, especially with tail shots. Don't waste your time with machine-guns; when you're up against gunships, their armor can't be penetrated.

**Sidewinder:** the father of the Sidearm, is one of the most successful and tested weapon systems in service. It's a highly maneuverable, fire-and-forget IR homer. It's long-ranged and packs a potent warhead. Like Sidearm, you don't have to get a target lock; just make sure to fire it towards the IR source. Long range multiple engagements are a simple process; just disperse the missiles so they don't home in on the same target.

**Stinger:** may be about half the weight of Sidewinder, but is certainly more than up to the task. You can also carry twice as many Stingers as Sidewinders; you never know when you may need those extra shots. While it may be shorter ranged, it'll reach just about every thing you can see. Some targets may take two hits, but those should be few and far between.

**Helstreak:** is a British import that's derived from the ground-based Starstreak SAM. It's carried by the Longbow Apache and the Comanche. It's not a fire-and-forget system; laser guidance must be provided by the launching helicopter. Therefore, a lock-on must be attained prior to launch. On the plus side, it flies faster than Sidewinder and Stinger, which reduces the exposure time. It's three element warhead covers a broad area, so close is probably good

enough. As an added advantage, it can also fire at ground targets. Its warheads can pierce most medium weight armor.

**Helicopters:** For the most part, Stingers and Helstreaks are more than adequate. It's the rare case where one shot won't do the trick; Sidewinders may be overkill. Don't discount Hellfires in a pinch. If the helicopter isn't moving too fast, you can reasonably maintain a lock, especially from hover. When you get in close, switch to cannon and "hose" them down. M255 rockets can also be a nasty surprise!

## TARGETS

---

## HELICOPTER FLIGHT COMMANDS

The essence of Gunship 2000 is the multi-helicopter operations. Through this mechanism, you direct the flying, combat and support functions of the other four helicopters in your flight. It's a simple, straightforward, yet powerful process that's executed through a series of single key commands.

After receiving your commission, the door opens to this challenging and exciting process.

---

### SYSTEM SUMMARY

Press the *Map View* (F10) key to access the flight commands menu. The commands are listed across the bottom of the screen. Commands available to the "active" section or helicopter display "brightly".

As you toggle through the helicopters, information relating to the "active" helicopter displays along the left side. The combat data link system automatically tracks key helicopter systems and mutually transmits this data via its communication link to all helicopters in the flight.

Map Commands Screen



### DAMAGE SCHEMATIC

The schematic helicopter diagram graphically displays damage to helicopter systems. A yellow burst over a system indicates damage; a red burst indicates system failure.

The Rotor, tail rotor, left wing, right wing, left engine, right engine and cannon indicate damage in their respective positions. Optics are located in the nose and/or mast mounted sight; avionics are located in the tail boom; and fuel cells are located below the cockpit positions. While these positions may not be true location in all helicopter types, the consistency helps speed recognition.

### HELICOPTER STATUS

The helicopter's current orders and key system indicators display below the damage schematic.

---

## COMMAND CONTROL

The command list is utilized to pass instructions to the other helicopters in the flight. Commands given to a section leader apply to all helicopters in that section. Helicopters in your section always fly your course, speed and altitude unless instructed to do otherwise.

All commands applicable to a section leader may also be given to a single helicopter. In this case, the helicopter deviates from the leader's control.

Press the *Next Unit* (n) key to toggle between the helicopters. If the helicopters are flying as part of a single section, the helicopters display in numerical order. If a heavy and light section are both operational, the other section leader displays first, followed in numerical order by the remaining helicopters.

Press the *Fly to* (f) key to establish a flight path. Up to three waypoints can be placed. This command is applicable to your helicopter.

Press the *Hold Position* (h) key to order the section to maintain its present position. The Section maintains its current altitude and heading, but reduces its airspeed to 0. This command can be given to a section at any point; it doesn't cancel existing waypoints. Pressing the key a second time cancels the hold.

Upon reaching its destination, the section immediately assumes a hold command.

Press the *Speed* (s) key to modify the section's airspeed. There are three possible settings- slow, medium and fast.

Slow speed is 50% of the possible maximum for the current altitude.

Medium speed (the default) is 75% of the possible maximum.

Fast speed is 100% of the possible maximum.

Pressing the key loops through the possible settings.

Press the *Altitude* (a) key to modify the section's altitude. There are three possible settings - NOE, contour and low.

NOE altitude (the default) is 20' higher than your present low altitude limit setting.

NEXT UNIT

FLY TO

HOLD POSITION

SPEED

ALTITUDE

Contour altitude is 150' higher.

Low altitude is 350' higher.

Pressing the key loops through the possible settings.

## LAND

Press the *Land* (l) key to order the section to land upon reaching its final waypoint. If no active waypoints exist, the section immediately lands. The section seeks out terrain suitable for a landing in the immediate area.

## RETURN TO BASE

Press the *Return to Base* (b) key to order the section to immediately return to base; all existing waypoints are cancelled. If on a deep strike mission, the section returns to the passage point.

The section initiates the default speed and altitude unless ordered otherwise. The section takes the most direct route to the base, and lands upon reaching its destination.

This command is applicable to your own helicopter. It sets a single waypoint with your base as the destination. You must initiate the autopilot or head towards the waypoint.

## DISENGAGE

Press the *Disengage* (d) key to order the section to immediately break contact and move away from all opposing forces. Upon reaching a "safe" position, the section assumes a hold command. This command cancels all existing waypoints.

The section disregards this command if not currently in contact with opposing forces.

## REGROUP

Press the *Regroup* (g) key to order an independent helicopter to immediately rejoin its section. It takes the most direct route, and initiates default speed and altitude settings. This command cancels all existing waypoints.

## WEAPONS FREE

Press the *Weapons Free* (w) key to order a section to engage all sighted targets. The section employs the appropriate weapons, if available, based on target type. Pressing the key a second time returns the section's weapons to "hold". Helicopters on "hold" status fly directly to their destinations.

The section freely employs defensive measures on either setting.

Press the *Cargo Drop* (c) key to order the section's cargo carrying helicopters immediately to drop their cargo. The section's UH-60 K/L Blackhawks drop their cargo upon reaching the Primary/Secondary waypoint.

---

**COMMUNICATIONS**

Communication is the key element to any successful operation. Since you're an active pilot in the flight, not some desk jockey, you must rely on your pilots to keep you abreast of developments.

During the course of a mission, your pilots communicate key information and status updates. The messages include target sightings, reaching destinations and damage updates.

Their call sign appears on the screen, along with their message. This enables you to fly your portion of the mission and not constantly check on flight status.

When important situations do develop, you can immediately access the Map view to re-evaluate and revise orders as necessary. You can also "jump on their tail" by pressing the *Flight Chase View* (shift F5) key to directly view the situation.

If, for any reason, you are unable to read an entire message, press alt m to re-display the last message.

---

**STRATEGY**

It's probably easier to just say I'll do it myself, but combat is a team effort. The commander that best employs flight assets will be the most successful. You could always keep the entire flight with you at all times, but that will limit your options dramatically. Give the other pilots a chance; they'll give you their best.

## EXPERIENCE

Use your flight to the best of its abilities. Inexperienced pilots may not do exactly what you had in mind. Developing skills and moxie takes time, just as you've probably found out by now. Experience is a measure of missions flown, rank and decorations. Your best pilot will have flown the most missions, is one rank under you, and has a chest full of decorations.

This pilot is your best choice for the other section leader. Avoid selecting that wet behind the ears W-01, fresh out of flight training. Don't ask any of them to do more than they're capable of accomplishing.

## COMMANDS

Try to envision yourself flying this leg of the mission; what would you do if you were there? Apply a command stream that accomplishes that image. If you give them poor orders, they'll perform poorly. You're their commander; they look to you for the right measure.

The tactics described earlier still apply here. Fly and fight smart!

## SCOUTS

Scouts play a very useful role as independent helicopters. Send one on ahead to look for enemy units and/or to clear a safe flight path. It's no use sending loaded Blackhawks into totally unfamiliar territory; their loads are just too valuable to squander away.

A Kiowa Warrior can also mark targets for Hellfire equipped Apaches, SuperCobras and Blackhawks. The gunships can wait safely behind a hill while the Kiowa Warrior is out looking for some ripe targets.

## AMBUSH

With the opposing forces constantly on the move, it's easy to stumble across a force occupying an area you thought was clear or just flew through a few minutes ago. It's usually expedient to position a helicopter in covering terrain along any suspected movement paths.

Also, a helicopter can be positioned to watch your "back door". This way you can be confident that your means of exit is clear of enemy forces when you need to get out quick.



## **SPECIAL CONSIDERATIONS**

Upon landing, UH-60K/L Blackhawks automatically drop off their passengers, unless at a base or FARP. Be sure they're at the correct location before giving the orders to land. They also automatically pick up any passengers, if in the vicinity, when they land.

Cargo drops are also automatic. Even though cargo can be successfully dropped without making a landing, it's easier to verify the location by landing first. Of course, if the LZ is "hot", you may be forced to drop the load and get out quickly.

---

## AFTER THE MISSION

### MEASURE OF SUCCESS

You've landed, and are relatively safe and secure. The S2 now wants to run through the debriefing. Never an easy read, you can't tell if he's pleased or disappointed. The mission replay indicates how well you did this time out.

If you do nothing else, complete the primary and secondary missions, and return safely to your base. If you can manage only one of the two, make it the primary. Destroying additional units is always a plus, but not at the expense of your missions. Stay focused, but flexible. The TF commander has a habit of changing missions.

Promotions and decorations are awarded for hitting the assigned missions and returning an intact helicopter to base. Time is also a performance measure. You can't spend the entire day flying just one mission; you need to get in and get out as quick as possible. There's only so many helicopters and pilots available, and more than enough mission to go around.

### DITCHING

If you land and abandon your helicopter, every attempt is made to pick you up, but you may be captured by the opposing forces. Naturally, the chance of rescue increases if you're near a base or FARP. The best bet is to make it back to base. It's better to return even if you can't complete your missions. You can always return to fight another day.

### CAMPAIGNS

When a campaign is completed, you are advised as to the outcome. This shouldn't be any surprise, you've known the progress all along. The campaign map is routinely updated when you attend briefings.

### PROMOTION

Successful completion of your assigned mission improves your overall record. An excellent record leads to promotion. However, even in combat, promotions take time. Don't expect a promotion after every mission. As you increase in rank, promotions are even harder to come by. After all, not everyone can be a Brigadier General.

A reprimand on your record makes promotion more difficult. Reprimands occur whenever you decline a mission, or you fail to achieve either the primary or secondary mission. On the other hand, decorations for heroism move you to the head of the promotion pack.

## BATTLEFIELD COMMISSIONS

The TF commander is always on the lookout for pilots with leadership potential. If you're selected to receive a commission, you're approached by the TF commander. The choice is yours to make; it's not required. However, accepting the commission does open the door to the exciting world of multiple helicopter flight.

The TF commander is persistent. He'll keep after you even if you decline a commission. If you continually decline the offer of a commission, CW4 is the highest rank you can attain.

If you do exceptionally well on a mission, you may be awarded a medal for heroism and valor. Unlike promotions, decorations are based purely on your performance during a single mission. Your current rank and record have no effect on your chance of getting decorated.

In addition to the decorations for heroism and valor, two other decorations can be awarded. The National Defense Service Medal is given for successfully completing training, and the Purple Heart is awarded for wounds received in combat.

## DECORATIONS

---

The mission replay summarizes the key events of your mission. It shows what went well and not so well. It's a learning experience; the next time out apply the lessons learned from this mission.

## MISSION REPLAY

Upon the completion of a mission, or if you access the mission films through the Squadron Archives, the Film Library panel appears.

## FILM LIBRARY

Here you select the film to view; the last mission flown is always titled "Last Mission". To select a film, position the cursor on the title line and press *Selector #1*; the selected title highlights. Press "Play" to begin the replay.

From this control panel, you may also rename and delete mission films. Remember, if you wish to save the current mission, you must rename "Last Mission" or it'll be lost after the next mission.

Once you fill the entire page, the slide bar to the right is used to scroll the film listing.

In this, the default viewpoint, replay displays the actual combat films from your mission. You are there again with your flight, with an "out of body" view

## EXTERNAL VIEWPOINT

of all the action. A short mission summary is displayed at the top of the replay screen.

A running list of events is displayed on the panel. This way you can follow along with the action as it happens.

## CONTROLS

Replay uses a "VCR" type panel to control the replay functions. During the Conventional Replay, the *Controller* is used to position the cursor over a key; press *Selector #1* to activate the key. As an alternative, the *tab* and *shift* keys can be used to position the cursor.

Position over and press the ( ▲▼▶◀ ) keys (or press the *directional* keys) to adjust the point of view.

Position over and press the ( |◀◀ ) key (or press the *r* key) to rewind to the beginning of the replay.

Position over and press the ( ■ ) key (or press the *s* key) to stop the replay.

Position over and press the ( ▶ ) key (or press the *p* key) to start the replay.

Position over and press the ( ▶ | ) key (or press the *n* key) to fast forward to the next event. Upon reaching the next event, replay automatically shifts into the "play" mode.

Position over and press the ( ▶▶ ) key (or press the *f* key) to fast forward.

Position over and press the ( 1, 2, 3, 4, or 5 ) keys (or press the respective *numeric* key) to shift the view to that helicopter. If the mission type was "Single", only the "1" key is active.

Position over and press the ( T ) key (or press the *t* key) to shift the view to the target.

Position over and press the ( RESUME ) key (or press *alt x*) to resume the fight.

Position over and press the ( DEMO ) key (or press *alt y*) to activate the Demo Viewpoint. Press *alt y* to return again to the external viewpoint.

## DEMO VIEWPOINT

The replay takes the "pilot's" viewpoint. In this mode, you view the mission from the pilot's seat. All actions are replayed exactly as they occurred in the actual mission.

To exit the replay, press *alt e*, this returns you to the game. To return to the control panel, press *alt y*.

## RESUME FLIGHT

Replay offers one additional exciting feature. You can jump in and take over a flight at any point during the replay! Position the cursor over the *Resume* key and press *Selector #1* (or press *alt x*).

This feature is an excellent combat tool for learning and developing tactics. You can re-fly a tough mission, change your tactics, and observe the impact of a revised plan of attack. Or, you can re-enter another pilot's mission, and see if you can top their results. These "films" are loaded via the squadron archives file.

When you re-enter a mission, you are positioned in the #1 helicopter and are now in control with all game controls active.

The results of a re-entered mission never affect your record, nor are the results of this "mission" recorded for future viewing. The original replay remains intact.

To exit, press *alt e*; this returns you to the game.

The pilots in your flight are also eligible for promotions and decorations. The high command makes recommendations as to who should be promoted and who should receive decorations. As the flight commander, you're authorized to accept the recommendations or transfer the awards to other pilots.

To change a recommendation, highlight the award and press *Selector #1*. The award is transferred to the next pilot. Promotions are automatically adjusted to the next higher rank. A pilot can't be promoted to a rank equal to your current rank. Decorations are awarded as presented.

When you concur with the recommendations or changes, highlight the *Accept* key and press *Selector #1*.

## REPLACEMENTS

If you're ever faced with the unfortunate situation of having lost a pilot in combat, you'll automatically receive a W-01 replacement from the pilot pool.

If you're not satisfied with the replacement or you wish to change an existing pilot, the pilot replacement screen is provided to make these administrative changes. You may replace the pilot, but the new pilot's rank and decorations are comparable.

Highlight the pilot to be replaced, and press *Selector #2*. Enter the name of the new replacement and then press *Selector #1*.

## FLIGHT PROMOTIONS

### Group Promotion Screen

The screenshot shows a 'Group Promotion Screen' with four pilot profiles in columns:

- PILOT 1:** CPT Johnson, HEAVY SECTION, AH-64A APACHE, MISSION SUMMARY. FLIGHT: 642 \*\*\*, ATTACK: 402 ecc, DAMAGE: 302. RECOMMENDATION: DSC.
- PILOT 2:** 1LT Brown, HEAVY SECTION, AH-64A APACHE, MISSION SUMMARY. FLIGHT: 152 \*\*\*, ATTACK: 512 ecc, DAMAGE: 102. RECOMMENDATION: DSC.
- PILOT 3:** 2LT Smith, LIGHT LEADER, AH-64A APACHE, MISSION SUMMARY. FLIGHT: 602 \*\*\*, ATTACK: 502 ecc, DAMAGE: 102. RECOMMENDATION: PROMOTION, SS.
- PILOT 4:** CPT Miller, LIGHT SECTION, AH-64A APACHE, MISSION SUMMARY. ATTACK: 402 ecc, DAMAGE: 402. RECOMMENDATION: PROMOTION, SS.

At the bottom, the 'RECOMMENDED RECIPIENTS' section lists:

- PROMOTE 2LT Smith to FIRST LIEUTENANT
- AWARD DISTINGUISHED SERVICE CROSS to 1LT Brown
- AWARD SILVER STAR to 2LT Smith

An 'ACCEPT' button is visible at the bottom left, and a 'Batachergers' logo is at the bottom right. A note at the bottom reads: 'SELECTOR #1 to change Recipients. ACCEPT when final.'

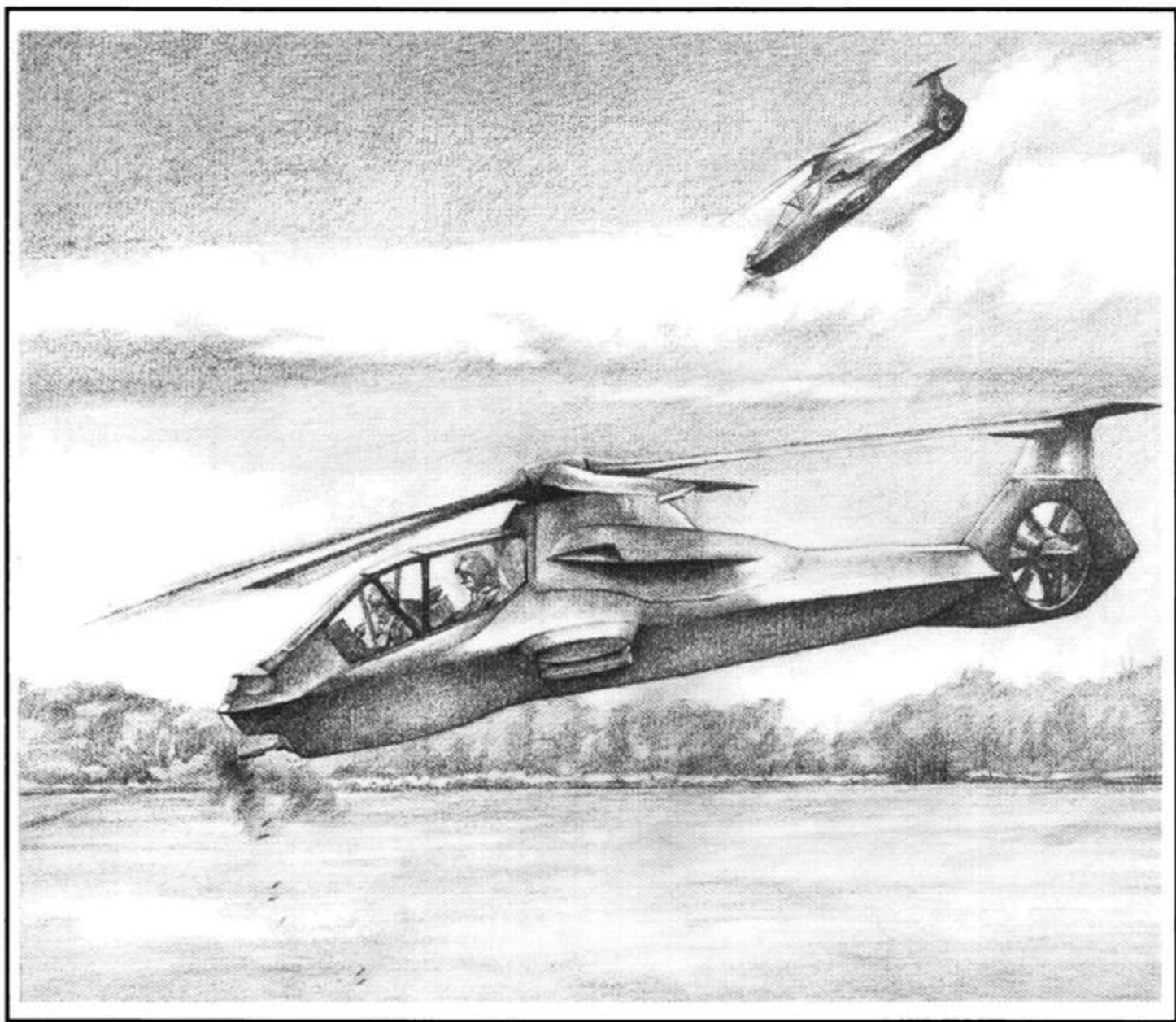

## 3. THE HELICOPTER

### HISTORY OF DEVELOPMENT

Leonard da Vinci is widely considered to be the “Father of the Helicopter.” In the late 15th Century, da Vinci developed the first theories of flight, and designed a screw-like rotary-wing aircraft that operated on the principles he developed.

Da Vinci’s Helix had a large, screw-like rotary wing. Da Vinci had theorized that air has a “substance”, or density, and that a lifting force could be generated by pushing down against it; it would, theoretically, bore through the substance of the air like an auger bit through wood.

While a full-size version of da Vinci’s Helix never flew, some small working models were produced. The problems that faced da Vinci’s craft would confront every would-be-inventor of a self-propelled helicopter. The power plant and structure of the aircraft needed to be kept low, the torque produced by the spinning propellers had to be counteracted, and the craft had to be controlled.

The next significant step toward rotary-winged flight occurred in 1783, at the World’s Fair in Paris. Two Frenchmen, Launoy and Bienvenu, created a toy rotary-wing craft with four feathered propellers. The propellers were placed on either end what was basically a stick, and turned independently of one another in opposite directions.

The toy, driven by a wind-up bent-bow system, managed to fly up to altitudes of seventy feet, and provided a great deal of inspiration for other inventors. But they still lacked a propulsion plant strong enough to generate the lift needed to get larger craft airborne. It would be nearly another hundred years before inventors would have any significant successes.

In 1862, another Frenchman named Ponton D’Amecourt developed a steam-powered helicopter. The craft had coaxial propellers, counter-rotating wings spinning about the same axis. The helicopter’s steam engine was made of

### FATHER OF THE HELICOPTER

### THE HELICOPTER TAKES SHAPE

aluminum, and weighed only four pounds. While the power-to-weight ratio of the craft was still too low for it to get airborne, it bobbed and bounced on the ground on the threshold of flight. This alone encouraged inventors to continue.

By 1870, an Italian inventor, Enrico Forianni, met with some success. His steam-powered coaxial helicopter weighed only six and a half pounds, but it managed to fly up to heights of 40 feet and for a duration of 20 minutes. Rotary flight, albeit unmanned rotary flight, was a reality. But the hurdles to manned flight - the power-to-weight ratio and control of flight - still remained.

The first breakthrough in manned rotary flight would not come until 1907, four years after the Wright brothers' first flight at Kitty Hawk. The development of internal combustion engines had finally produced a power plant with a sufficient power-to-weight ratio to be effective, and yet another Frenchman, Paul Cornu, set out to take advantage of that new technology.

His craft had dual rotors, one placed forward and the other at the rear of the fuselage. Each rotor measured twenty feet in diameter. The rotors were connected by drive belts to a 24-horsepower internal combustion engine. For control of flight, Cornu had placed tilted vanes below each rotor.

The belts slipped and the rotors spun unevenly, but Cornu's helicopter became airborne. His flight was short, and he only managed to rise a few feet above the ground, but he had flown!

Many other helicopter designs followed; but for the next ten years, few met with any greater success than Cornu's. Control remained the greatest problem. And while World War I had a drastic effect on the evolution of the airplane, it produced few advances in powered rotary-wing flight.

The 1920s saw two major step forward in rotary wing aircraft design. The first was in 1922, when Raul Pateras, an Argentinean, built (with the backing of the French military) a coaxial helicopter with controlled-pitch propellers. The controllable pitch of the rotor blades while in flight increased the maneuverability, and the craft also demonstrated the effect of autorotation - allowing the rotors to spin freely in unpowered flight to slow descent.

The second major step forward came not in the form of a helicopter, but from an entirely different aircraft. Juan de la Cierva, a Spanish airplane designer,

## THE AUTOGIRO



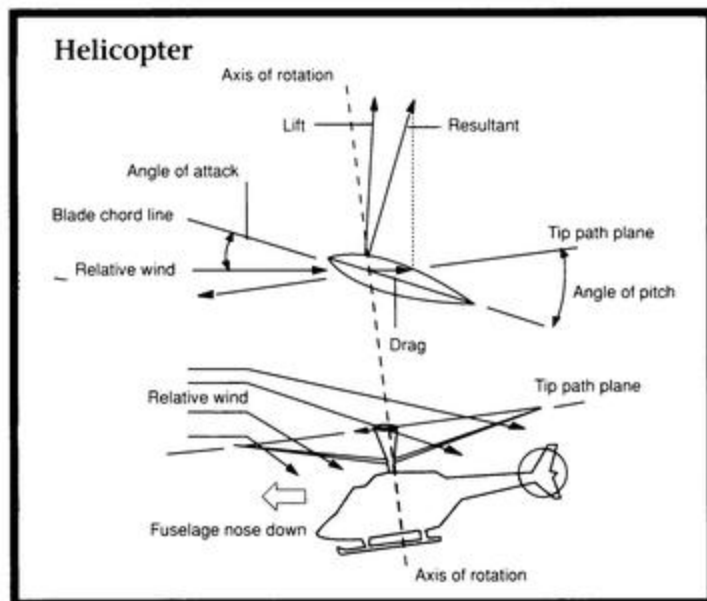
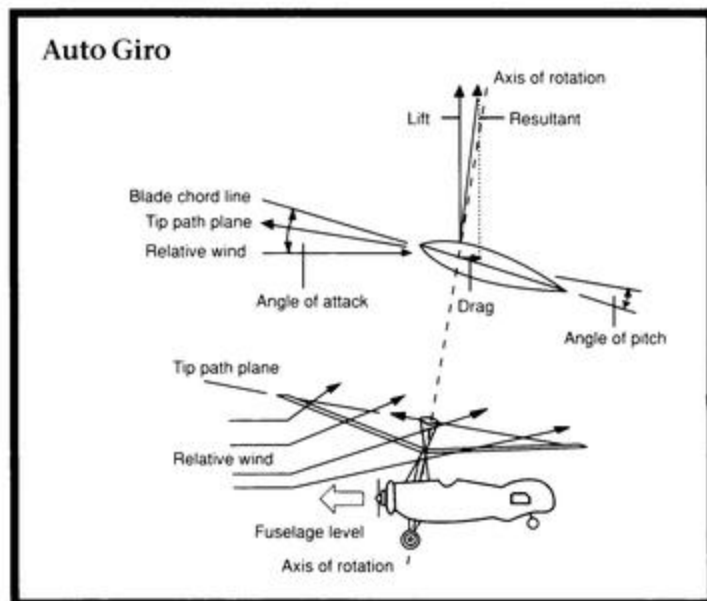

decided to investigate rotary winged flight in 1924, and soon after unveiled an entirely new type of aircraft - the autogiro.

Rather than using a powered rotary wing for lift, the autogiro has a freely rotating overhead wing that is allowed to windmill. The forward motion of the aircraft through the air, generated by the thrust of a conventional propeller, causes the rotor to spin and generate lift. Consequently, the autogiro cannot hover; but it can take off and land in a substantially smaller area than conventional aircraft. In 1928, de la Cierva flew his autogiro across the English Channel, attaining an airspeed of nearly 100 miles an hour.

The autogiro found its way into the hands of the military in limited numbers, mostly for evaluation purposes. One was the first rotary aircraft flown off a ship, launched from the carrier USS Langley on September 23, 1931; another was evaluated by the Marine Corps during operations in Nicaragua in 1932. Admiral Richard E. Byrd used an autogiro during his exploration of the Antarctic in 1933 and 1934, and the Army tested several autogiros between 1935 and 1938.

But all of these craft were "of-the-shelf" civilian models, and little more was

## WORLD WAR II

done with the craft. Some military applications, such as antisubmarine warfare and artillery spotting, were noted, but there was little real interest in further development; its low payload capacity and its inability to take off vertically made it unsuitable for what the military had in mind.

The Second World War accelerated the development of helicopters dramatically, especially in Germany. The first truly practical helicopter, the Focke-Achgelis Fa61, was built for the Third Reich by Dr. Heinrich Karl Johann Focke, and flew for the first time on June 26, 1936 (even though he had been marked by the Nazis as being "politically unsafe").

The Fa61 was a single-seat aircraft, with side-by-side three-bladed rotors and a conventional propeller for forward thrust. Both the rotors and the propeller were powered by a single 160 horsepower engine.

The craft proved to be difficult to fly at first; eventually, it was mastered by Hanna Reitsch, one of Germany's most respected test pilots. In February of 1938, she flew the Fa61 in the Berlin Deutschlandhall sports arena, demonstrating the helicopter's incredible handling characteristics. She later described the experience as "intoxicating."

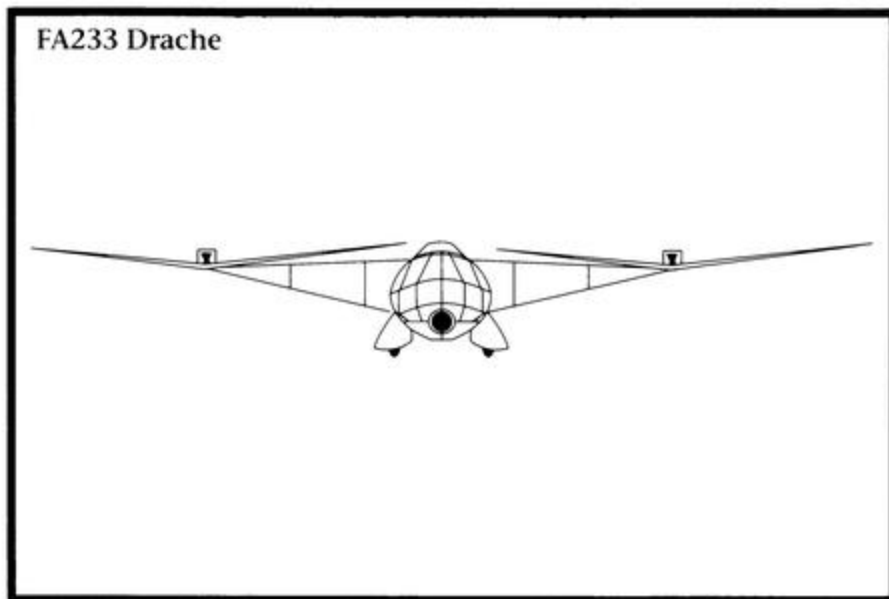

Reitsch and the Fa61 went on to set numerous world records for rotary flight between 1937 and 1939, proving the practicality and reliability of the helicopter once and for all. Among its records were a top speed of 77 miles per hour, a distance of 143 miles, and an altitude of 11,243 feet.

While Dr. Focke did not intend the helicopter for military applications, the Nazis had other ideas. Another German, Anton Flettner, built what is considered to be the world's first military helicopter - the F1 282 Kolibri. The Kolibri had twin counter-rotating propellers that turned in synchronization, their planes of rotation intermeshing. Flettner's Kolibri flew for the first time in 1940, and by 1942 was operational on German airships and escorts in

the Mediterranean, Aegean, and Baltic Seas. Eventually, a modification of the Kolibri was used for antisubmarine warfare.

Another Focke design, the Fa 233 Drache, was the world's first transport helicopter. The Drache, which carried six passengers and could carry a cargo load suspended from a cable, was tested extensively for use as a general purpose transport for mountain troops. Allied bombing raids destroyed all but seven, and by 1945 only three remained serviceable. These were formed into the first (and only) WWII Luftwaffe helicopter squadron, Transportstaffel 40.

While more Fa 233's were built, only one additional helicopter was ever completed. At the end of the war, only two operational helicopters remained.

In the United States, Igor Sikorsky's Sikorsky Aircraft Company received a contract from the U.S. Army for a two-passenger observation helicopter. Sikorsky had earlier demonstrated a prototype helicopter, the VS-300, and the success of that aircraft had finally drawn the interest of the Army back to rotary-winged flight.

In January of 1942, Sikorsky's Army prototype, the XR-4, flew for the first time. By the time it was delivered to the Army on May 17, 1942, it had broken practically all of the existing world records for helicopter operations. The U.S. military was now thoroughly convinced of the helicopter's potential.

The R-4's design, like Sikorsky's VS-300 before it, utilized a single rotor with three blades, and a tail rotor to counteract the torque of the main rotor. This design set the standard for the great majority of American helicopters that followed it.

By the end of WWII, over four hundred Sikorsky helicopters of three designs were flying for the Army, Navy and Coast Guard, and for the British Navy and RAF. They served as scouts, delivered mail to ships at sea, and served as rescue craft during carrier operations. In addition, the growing need for antisubmarine platforms gave the helicopter an active combat mission in fleet operations; with the advent of the dipping sonar in the mid-1940s, the helicopter became a viable sub-hunter.

In 1944, the helicopter saw its first duty as a combat search and rescue (C-SAR) and medevac craft, during operations in Burma. In April of that year, Sikorsky R-4 helicopters attached to the U.S. Army's First Air Commando Group, based

at Hailakandi, India, were fitted with fuel tanks from fixed-wing aircraft to extend their range, and were flown behind enemy lines to rescue the crew and passengers of a light British medevac aircraft. The mission was a success, and the R-4 was called upon almost daily afterward for other SAR missions.

## THE MALAYAN EMERGENCY

The first real conflict in which helicopters were used extensively was the Malayan Emergency, a counter-insurgency war fought by the British for twelve years beginning in 1948. By the time the Korean War began, the British already had nearly forty thousand troops fighting a guerilla war against Chinese-backed communist insurgents. British forces depended heavily on helicopters in this jungle war, for medical evacuation, troop transport, observation and reconnaissance. The operational flexibility of helicopters, along with their ability to deploy and retrieve troops in jungle terrain, proved their worth in combat beyond a shadow of a doubt.

## THE KOREAN WAR

The Korean War was to U.S. helicopter aviation what the Malayan Emergency was to the British. During the course of the war, the helicopter was used by all four branches of the armed forces, and tactics were developed for their use.

While the helicopter was primarily used for transport, medevac, search and rescue, and reconnaissance by all of the services, there was some unofficial experimentation with gunship tactics. For the first time, helicopters became a threat to enemy troops.

The first shots fired in anger from a helicopter were from a U.S. Navy helicopter in January, 1951. Lieutenant, j.g. John W. Thorton and his crewman, Petty Officer Whitaker, experimented with light attack helicopter tactics by firing .45 caliber pistols and carbine rifles and dropping grenades from their HO3S-1 on North Korean troops. If fragmentation grenades were not available, LTJG Thorton would obtain percussion grenades and tape nails to them, so they could "nail them to a tree."

These tactics did not endear Thorton to the North Koreans, nor to his fellow pilots. The North Koreans quickly learned that the helicopter was a potential threat, and soon were firing upon all they saw.

The HO3S-1 had been the subject of another experiment in helicopter armament a year earlier, at Lakehurst Naval Air Station in New Jersey.

Mechanics at Helicopter Utility Squadron One (HU-1) attempted to install swivel gun mounts with .30 and .50 caliber machine guns in the doors of a helicopter. Unfortunately, the airframe wasn't strong enough to support the guns, and when they were fired, they nearly ripped the sides of the aircraft off. The experiment was only slightly ahead of its time.

The Army experimented with the idea of an armed helicopter during the war. The need for armament aboard helicopters became apparent when the H-19 troop transport helicopter was deployed to Korea - it proved to be extremely vulnerable during troop assault landings. The Army tried mounting a bazooka on an H-13 helicopter in 1950, with little success; three years later, the Army tried a grenade launcher, with the same result.

American experience with the helicopter during Korea led to the development of the "Air Cavalry" concept. General Matthew B. Ridgeway, who had seen the importance of the helicopter in Korea, reorganized Army aviation in January 1955, and laid the foundation for the modern "Air Cav". Accompanying this new organizational concept was that of a "helicopter gunship".

In 1956, the Army began testing various types of helicopter armament again, with the goal of providing an effective for providing suppressive fire during assault landings. Air Cavalry units experimented with .30 and .50 caliber machine guns, rockets, and various cannons. Eventually, these experiments led to the formation of an aerial combat recon company in 1958.

The French would be the first to apply the gunship concept under actual combat conditions. During the bloody French-Algerian War, the French Army and Air Force applied the American experience with helicopter armament to their Vertol H-21's twin rotor helicopters originally built for troop transport.

The French used several mixes of armament, from .30 and .50 caliber machine guns to 37 mm rockets and 20 mm cannon in their war against the Muslim rebels. The French also armored their helicopters, using self-sealing gas tanks, and fiberglass armor plating around engine compartments and the cockpit. After adding weaponry and armor to their helicopters, the French did not lose any helicopters to ground fire. The French also pioneered the development of a helicopter-launched anti-tank missile, in 1958.

While the French had some success with the use of helicopters during the

French-Algerian War, in the end they were forced to quit Algeria, granting their former colony independence. The helicopter alone could not win a guerilla war. Still, the utility of the armed helicopter had been proven, and important lessons had been learned about its employment.

But the real test of "Gunship" weapons and tactics would come with the escalation of a war in another former French Colony - Vietnam.

## THE VIETNAM WAR

The Vietnam War has often been called the "Helicopter War" because of the pivotal role that helicopters played in all aspects of the conflict. U.S. forces depended heavily on the helicopter because of its utility and flexibility in an environment similar to that the British faced in Malaya during the early '50s. During the conflict, more helicopters, and more types of helicopters, would be used than ever before. Some eighteen types of helicopters were flown by U.S. pilots over the course of the war (many of which are still in service today in some capacity). The war also saw the first widespread use of gas turbine-powered helicopters in all facets of operations.

The first gas turbine-powered helicopter deployed to Vietnam became a symbol of the war itself - the UH-1 Iroquois, more commonly known as the Huey. First delivered to the Army in 1959, the Huey was commonly referred to early on as the "helicopter ambulance," despite its multi-role design. The Huey was remarkably successful in all of its roles, and eventually over nine thousand were built - many are still in service.

The UH-1B Huey became the first true helicopter gunship. It was built with universal wiring and "hard points" for the attachment of various weapons systems. Three weapons were used by the UH-1B: the XM-6 quad (four 7.62 mm machine guns and four grenade launchers, mounted in pairs on each side of the ship), the XM-3 rocket pod system (two pods of 24 2.75 inch rockets), and the SS-11 guided anti-tank missile (three guided missiles mounted on each side of the helo). While the XM-3 and SS-11 systems were not available early, the XM-6 quad was almost universally in use as early as 1962, giving the Huey a lethal punch.

Huey 1A's were also equipped with weaponry, though their lower turbine power and lack of universal wiring limited the range of weapons available. They were equipped with two fixed rocket pods and two 30-caliber machine guns, mounted on the skids of the aircraft.

The first Huey 1A's and 1B's to arrive in Vietnam were organized into the Utility Tactical Transport Helicopter Company (UTTHCO). The 1B's proved to be much more flexible in meeting the needs of the local commanders. Almost as important as the 1B's better armament mix was its higher shaft power, essential for maneuverability in the high humidity of Vietnam. The gunships provided light close-in fire support for assault landings of airborne troops, and were essential to the evolution of the "airmobility" strategy of the U.S. Army.

The "airmobility" concept emerged in the early sixties as a product of a study by a board of Army officers convened by Secretary of Defense Robert MacNamara. The Army Tactical Mobility Requirements Board, also known as the "Howze Board" (for its chairman, General Hamilton H. Howze, an experienced Airborne commander), recommended the substitution of helicopters for a large amount of the Army's ground transportation. All Army units would be equipped with 360 air vehicles to every 2000 wheeled land vehicles.

The committee also recommended the formations of specialized, completely airmobile "air assault divisions". The concept of the Air Assault Division was tested by a skeleton division formed at Fort Benning, Georgia, in 1964. During exercises in North and South Carolina, the division proved itself against the 82nd Airborne.

The Secretary of Defense recognized the effectiveness of such a unit, and gave the Army the approval to proceed with organization of the first airmobile division. The division selected for this honor was the famed 1st Cavalry Division. On July 28, 1965, President Johnson ordered the 1st Cavalry Division (Airmobile) to Vietnam.

As the war escalated, and helicopters took increasing amounts of ground fire from heavy antiaircraft weapons, it became apparent that a dedicated helicopter gunship was needed. The UH-1B, while highly successful, was limited in its capabilities - it was, after all, just a modified logistics helicopter. Bell Helicopter had foreseen the Army's need, and was preparing to meet it. In 1966, the Army ordered its first true gunship - the Bell AH-1 Huey Cobra.

The Cobra was based on the UH-1B, but had some major innovations. The airframe was narrow, presenting a very small head-on target. The very look of the helicopter suggested its purpose - it was death from above for the enemy.

The first Huey Cobra went to Vietnam in 1968. Perhaps their most famous role in the war was the operations conducted by AH-1's over the Ho Chi Minh Trail, ambushing North Vietnamese and Viet Cong supply trains. It was during these ambushes that Cobra pilots developed tactics like "Cobra Stacking," flying one above the other to maximize the amount of ordnance delivered on a small area.

But the AH-1s also earned their keep in the troop transport escort role as well, protecting assault helicopter landings and providing "instantaneous fire suppression". The Marine Corps found them vital to carrying out their mission.

With a broad range of weaponry, high speed and high maneuverability, the Cobra proved to be a very important asset to American field commanders; its success insured the long line of gunships that followed it. Many other nations have copied it, and the Army and Marine Corps use modifications of the AH-1 (particularly the AH-1W Super Cobra) to this day.

## AFGHANISTAN

Vietnam was the proving ground for American gunships; for the Soviets, Afghanistan served a similar role.

While the Soviets had been pioneers in heavy lift helicopter design and construction, and had been arming helicopters since the early 50s, their first helicopter gunship was not introduced until 1972. The Mi-24 Hind-A was really a heavily armed and highly mobile transport helicopter. It is believed that the Hind-A was designed to act as its own fire support during troop insertions; the Soviet staff believed at the time that they could not afford a large number of single-purpose helicopters.

Soviet attitudes about gunships changed over time, and the Hind went through a series of modifications. The Hind-D was equipped with a nose-mounted gatling gun. Still, the Hind retained its transport capability; the Hind-E, introduced in 1976, can carry up to ten troops with its full weapons load. With its weaponry and heavy armor, the Hind is comparable to a very fast and maneuverable flying armored personnel carrier.

In December of 1979, the Soviets invaded Afghanistan under the pretenses of an invitation by the Afghani government. By mid-January, the Soviets had more than 75,000 troops in the country.



The Hind gunship was the workhorse of Soviet aviation in Afghanistan; nearly 200 of them were deployed by January of 1983. The Hind served in a role similar to the Cobra in Vietnam, escorting troop transports in assaults on guerilla concentrations. But like the French in Algeria and the Americans in Vietnam, the Soviets faced an enemy that enjoyed considerable freedom of movement, superior knowledge of the terrain and had the will to fight. The Mujahadeen also had U.S. made Stinger anti-aircraft missiles, a great threat to the Soviet helicopter forces.

One Soviet soldier said after the war, "You could tell when a landing zone was really hot by the number of assault troops they put on a helicopter. The more men a (Hind) had to land, the longer it was vulnerable to guerilla fire. If you had four or five to a helicopter, it wasn't too bad. If you had two or three to a helicopter, you knew it was really bad."

As the threat to Soviet helicopters increased, more and more infrared decoys (essentially flares) were carried to draw away the Stingers of the Mujahadeen. And the Soviets also reportedly deployed chemical weapons in large numbers from Hinds.

In 1983, the U.S. and a coalition of Caribbean States invaded the isle of Grenada to overthrow the oppressive Marxist military junta that had recently taken power.

During the invasion, code-named Operation Urgent Fury, U.S. Army and Marine forces met stiff resistance from Cuban "advisor" forces, and fought a heavily armed and fortified force holed up in the island's fortress prison. AH-1 Cobra gunships proved their versatility and, unfortunately, their vulnerability during engagements with these forces. Army Cobras and Marine SeaCobras provided close air support and assaulted the fortress with TOW missiles, but two of them were lost to ground fire.

Other Marine helicopter forces were used in the mission to rescue American students at the St. George's Medical School. These Marine Sea Knights were used as well for "vertical envelopment" assaults on the island in the early stages of the operation.

Lasting only a few days, the operation is not considered to be one of the high points in U.S. military history. It's generally felt that U.S. forces will ill-prepared

## **GRENADA - OPERATION URGENT FURY**

## THE APACHE IS BORN

for the level of opposition, and rushed into the operation with too little planning. In any event, its effects went a long way to shape the future of helicopter operations.

In the early 70s, the U.S. Army sought a heavy gunship in the form of the AH-56 Cheyenne. The program was cancelled, however, and for the remainder of the decade, the only heavy helicopter gunships in the U.S. inventory were on paper. The Cobra was called upon to fill the gap.

The 70s saw an increased emphasis on the anti-armor capability of the helicopter gunship. With the addition of the TOW missile to the Cobra (and later the SuperCobra), and similar weapons to the helicopters of other nations, the gunship was becoming a real “force multiplier”, with greater anti-armor capability than most ground units.

In 1976, the Hughes Aircraft design for the all-weather heavy helicopter gunship, the AH-64 Apache. It would be stuck in development for another six years before the production line got rolling. In the meantime, the U.S. invaded Grenada in 1983. The Cobra provided the only dedicated gunship capabilities available at the time.

Now fully operational, the Apache is the front-line anti-armor aircraft of the U.S. Army. The AH-64 marks the true beginning of a new generation of helicopter gunships - highly automated, heavily armed, and capable of combat in all weather, night or day. While the airframe is essentially a conventional helicopter, the advanced electronic systems aboard the Apache make it the link to future helicopter gunships. It is being considered for a number of other mission areas, including anti-ship missions.

There is still a great deal over debate as to which type of helicopter technology should be the basis of the next generation of gunship.

## PANAMA - OPERATION JUST CAUSE

In the early months of 1989, relations between the U.S. government and the regime of General Manuel Noriega in Panama were rapidly deteriorating, and by the end of spring, events had reached a flash-point. After a number of violent incidents, including the killing of an off-duty American soldier by Panamanian Defense Force (PDF) troops, the crisis escalated, and the United States mounted an invasion of Panama to remove General Noriega and put the elected president of Panama in power. Operation Just Cause, as the invasion

was called by the military, lasted only a few days, but it demonstrated the lethality of modern weapons.

Operation Just Cause saw the first use of Apache helicopters in actual combat. AH-64A Apaches were used in the attack on the PDF Commendancia in downtown Panama City - the helicopters were used against targets on individual floors of the building. Ground based laser designators were utilized to pinpoint the targets for the deadly accurate Hellfire missiles.

While, there was no opposition to U.S. helicopters during the operation, the Apache proved itself an effective weapon nonetheless.

The Apache would get its first real test on the battlefield during the quick and bloody war with Iraq in January and February of 1991. On August 5, 1990, Saddam Hussein's army invaded the city-state of Kuwait, and Hussein proclaimed its annexation. The United States quickly mobilized a coalition of nations to come to the defense of Saudi Arabia, and began putting pressure on Iraq to withdraw from Kuwait.

By January, the United States had completed the largest deployment of troops since Vietnam, and was ready to take back Kuwait by force. With the aid of the British, Italian, French, Saudi and Kuwaiti air forces, an air offensive was launched on January 16 against Iraqi forces in Kuwait and Iraq. Apache gunships played a significant role in the early air campaign, attacking Iraqi positions in Kuwait and Iraq.

The first mission for the AH-64 came during the first hours of the war. On the night of January 17, Apaches were sent in to take out two Iraqi electronics installations near the Saudi-Iraqi border. The Apaches launched Hellfire missiles at several targets in Kuwait and Iraq, including mobile air defense sites and electronics sites. All objective targets were destroyed. In some cases, it was reported that Special Forces troops provided forward laser designation for Hellfires launched by Apache gunships.

The night-fighting abilities of the Apache were used heavily during the first phase of the war. Apaches were used against a variety of fortified targets during night operations, including Iraqi artillery batteries and radar sites. Iraqi forces attempted to begin the ground war on their own terms in early February, by invading the Saudi coastal city of Kafji. Apache helicopters took part in a

## **THE PERSIAN GULF - OPERATIONS DESERT STORM AND SABRE**

night time assault on the Iraqi armored forces there, and during combat accidentally fired on U.S. armored vehicles, killing two American soldiers. This incident highlights the hazard of the modern battlefield, where smoke, fire and darkness can make it difficult to separate the enemy from friendlies on the ground.

With allied air superiority established, Apache gunships and other helicopter forces raided the Iraqi rear at will. On February 20, OH-58D Kiowa Warriors and AH-64 A Apaches destroyed "fifteen to thirty" Iraqi bunkers in Kuwait, and 421 Iraqi soldiers surrendered to them. Only one US serviceman was killed in the operation.

In the early hours of February 24, a combined allied air-ground offensive began. The operation, code named Desert Sabre, lasted 100 hours, and nearly completely destroyed the Iraqi armed forces in and near Kuwait. Apache and Cobra gunships played an important part in the offensive, taking part in some of the largest armored battles since World War Two. In fact, the first shots fired during the operation were by Apache gunships.

The 1st Marine Division was assigned one of the more difficult missions of the offensive - a frontal assault on Iraqi defensive lines in Kuwait. After punching through Iraqi fortifications, the division pushed on toward Kuwait City. In a battle with an Iraqi armored brigade and mechanized infantry brigade near the Burquan oil fields, Marine AH-1W SuperCobras and ground forces destroyed about 30 enemy vehicles. This battle proved to be only a prelude to the tank battle that would follow at Kuwait International Airport, where an estimated 310 Iraqi tanks were destroyed.

To the west, the 101st Airborne began a heliborne assault into Iraq, with over 460 Blackhawk, Apache and other helicopters. Their operation, nicknamed "Cobra", severed Iraqi roads along the Tigris and Euphrates rivers, and cut off the only Iraqi escape route to the north.

On February 28, the operation ended, having taken over 80,000 Iraqi POWs and having destroyed or "rendered ineffective" at least 40 of the 42 Iraqi divisions. No US aircraft were downed during the last phase of the war - a tribute to the level of organization planning employed and to the men and women that took part in the operation.

The operation more than reaffirmed the role of the helicopter in modern combat operations.

Today, the Army deploys its helicopters as integral parts of nearly every type of division, from light infantry to heavy armor. As a result, the battlefield commander of any Army formation will have some “organic air support” within his assets. The highest concentration of helicopters of all types is within the airborne and air assault divisions; within a typical air assault division, for example, there is one full squadron of air cavalry and an aviation brigade consisting of eight helicopter battalions.

The air cavalry squadron’s primary missions are “airmobility” and reconnaissance, so its aircraft will be of the troop transport variety — UH-60 Blackhawks and probably a few UH-1 Hueys . In addition, the squadron will have some AH-1 Cobra gunships for escort and air reconnaissance.

A squadron will usually have about 950 soldiers assigned to it: 70 commissioned officers, 100 warrant officers and 780 enlisted men. These personnel are divided among the squadron’s four “troops” and headquarters “troop.” A single troop of air cavalry will have about 200 men assigned, with 15 commissioned officers and 32 warrant officers among them.

The aviation brigade within an air assault division is made up of some 1000 personnel, and is broken down into four mission groups: assault, medium lift, command, and attack. Two assault helicopter battalions are dedicated to the combat troop transport mission , and are equipped with UH-60’s. The medium lift helicopter battalion, equipped with CH-47 Chinook cargo helicopters, provides logistical air support for the division, while the command helicopter battalion provides administrative, scouting, and command and control support for the division commander with its UH-1 Hueys and OH-58 Kiowa scouts.

The other four battalions of helicopters in the aviation brigade are attack helicopter battalions. These units are equipped with a mixture of aircraft, including AH-64 Apaches, OH-58 Kiowas and probably some AH-1S SuperCobras. These units are manned by some 20 commissioned officers, 44 warrant officers, and 177 enlisted men per battalion.

In addition to these air assets, the division will also have an air ambulance company assigned to its medical battalion, equipped with UH-60 and UH-1 helicopters and dedicated to air medical evacuation.

The number and type of helicopters that are assigned to a unit may vary with the theater of operations that they are assigned to and their level of readiness.

There are large numbers of helicopters considered “obsolete” for front line troops that have been widely spread through the Army’s aviation reserve units. As demonstrated during Operations Desert Shield, Storm & Sabre, these units may quickly find themselves on or near the front line of any conflict of arms.

The number and type of helicopters assigned to a mission group during operations will also vary widely, depending on the theater of operations, the mission objective, and other forces deployed in the area. For example, a formation of Apaches may be supported by Special Forces units on the ground (with laser designators for their Hellfire missiles), or they may need a Kiowa scout configured for laser designation to accompany them if there are no forward forces to support them. The terrain, battlefield conditions, and weather may all be factors in deciding the number and type of aircraft to assign to any specific mission.

---

## FLYING THE HELICOPTER

Flying a helicopter is a lesson in the physics of vectors. It places a great demand on the ability of the pilot to simultaneously control each of the factors affecting the flight of his aircraft. The following material only begins to scratch the surface of the intricacies of rotary-wing flight.

The four basic forces, or vectors, that act on all aircraft are gravity (which pulls the craft down), lift (which pushes it up), thrust (which moves the craft horizontally), and drag (resistance against thrust). These four forces, and to what degree they act on an aircraft determine if and how well it flies. Changing the weight, lifting surfaces, thrusting power and airframe shape all change the vectors that act on an aircraft and, consequently, change its flight characteristics.

Helicopters and airplanes both get their lift from an airfoil - a shape that creates lift from relative motion through the air. An airfoil is shaped so that air moving across the top of it must travel farther than air crossing along its bottom; this creates a condition known as the Venturi Effect, in which an area of low air pressure is created above the airfoil. As a result, the airfoil is drawn upward into the low pressure area, creating a lifting force.

Conventional airplanes depend on the relative motion of air across their fixed wings, caused by forward motion, to create the lift necessary for them to get and remain airborne. As a result, lift for an airplane follows the thrust of its engines; the more thrust available, the more lift an airplane can get out of its wings, or the less wing surface it needs to generate that lift.

Helicopters, on the other hand, get all of their lift and thrust from one source - the rotor blades; these are the helicopter's "wings". Since the helicopter spins its lifting surfaces through the air, it creates the relative motion necessary to generate lift without having to move the whole helicopter through the air. This is why helicopters can hover and maneuver at low speeds.

Unlike the wing of an airplane, the blades of a helicopter's rotor are symmetrical - the top and bottom of each blade is shaped the same. Thus, if they were allowed to spin perfectly flat, they would provide no lift at all. The difference in surface area needed to create lift is achieved by changing the

## THE BASIC FORCES

## LIFT, THRUST AND THE HELICOPTER

## Rotor Configuration



Penny-Farthing



Twin-Tandem



Twin Side-by-Side



Twin-Intermeshed

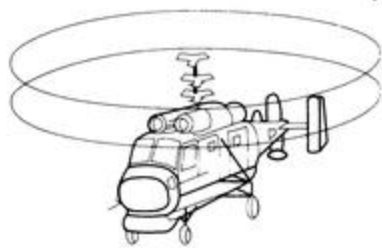

Twin-Coaxial

pitch, or angle of the blades. By increasing the tilt of the rotor blades, a helicopter can essentially take a bigger “bite” out of the air and create more lift.

The helicopter’s directional thrust - the force that moves it horizontally - is created by tilting the plane of the rotor blades’ spin. When the rotor is tilted, it pulls the helicopter in the direction of the tilt, as well as providing lift.

There are four basic configurations for helicopter rotors. The most common is what the British call “penny and farthing” - the single overhead rotor with a smaller stabilizing tail rotor. The smaller rotor counteracts the torque generated by the main rotor. Another common rotor configuration is the twin tandem - two rotors, one forward and one aft. The rotors revolve in opposite directions to counter act each other’s torque.

The twin side-by-side is not very common among military helicopters. In this configuration, the rotors are mounted on the side of the helicopter, and often intermesh. Several commercial helicopters manufactured by Kaman used this design. The coaxial rotor configuration is most commonly used by Soviet helicopter designers, and can be seen in the Hormone, Helix, and the new Hokum helicopters. Two counter-rotating sets of rotor blades revolve about the same axis, counteracting each other’s torque.

## DISSYMETRY AND ASYMMETRY OF LIFT

Since a helicopter’s rotor blades spin about an axis, the relative speed of air over the rotor blades is slower toward the inside of the blade and faster toward the tip of the blade. This means that a greater amount of lift will be created at the tips of the blades, so the blades will tend to bend up at the ends. This phenomena is known as dissymetry of lift.

Also, if the helicopter is moving forward , one side of the rotor (the side spinning toward the direction of movement) will have a higher relative air speed than the other (spinning away from



the direction of movement). This effect is called asymmetry of lift. The effect, first noted by Juan de la Cierva during his development of the autogiro in the 1920's, tends to make rotary-winged aircraft roll to one side unless it is compensated for. In most cases, helicopter designers have adjusted to this effect by hinging the blades, allowing them to rise slightly while they spin forward.

Since the helicopter's rotor blades are spinning, another force is exerted on the helicopter - torque. When a helicopter has only one rotor, the torque generated by that rotor tends to turn the helicopter in a direction opposite of the spin of the rotor blades. This is counteracted in most helicopters by a tail rotor, which pushes back against the torque. In helicopters with two rotor blades, the rotors spin in opposite directions and the torque is cancelled out.

Torque can also be used to the helicopter's advantage. Torque, in conjunction with the tail rotor, can be used to help turn the helicopter in flight, and pivot the helicopter about its axis when it's hovering.

## TORQUE

### Blade Tip Speed

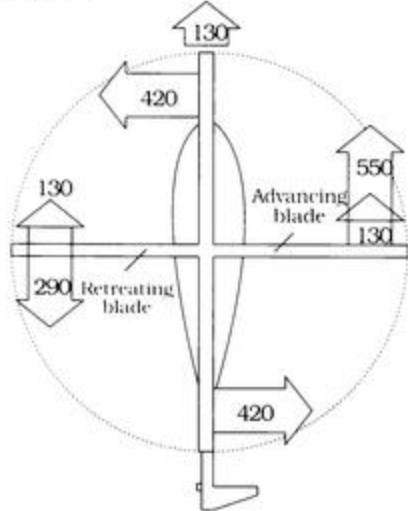

### BLADE STALL AND AIR COMPRESSIBILITY

There are two properties of helicopter flight which significantly limit the top speed of all helicopters. The first of these is called blade stall. As a helicopter accelerates its forward flight, its rotor tilts forward, adding thrust. As it does so, the angle of attack, or the angle of the blades in relation to the direction of flight of the "retreating" blades becomes steeper. When the helicopter exceeds its maximum speed, this angle becomes too great, and the retreating blades stall - they cease to provide lift - just as an airplane stalls when flying at too low a speed.

The second speed-limiting factor affecting helicopters is the compressibility of air. The faster the rotor spins, the greater the airspeed of the advancing blades; when the relative speed of the advancing rotor blades exceeds the speed of sound, a wave of compressed air, known as a shock wave, forms in front of the blades, increasing the drag on the blades and possibly decreasing lift.

### Torque

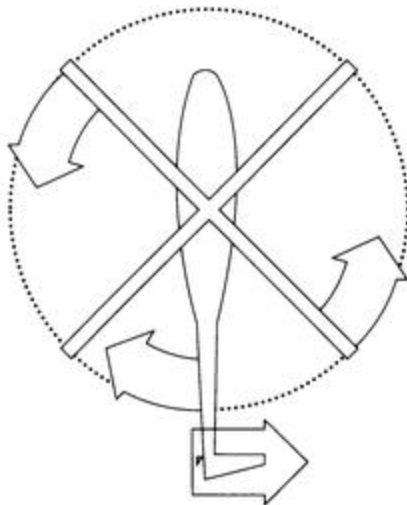

### Retreating Blade

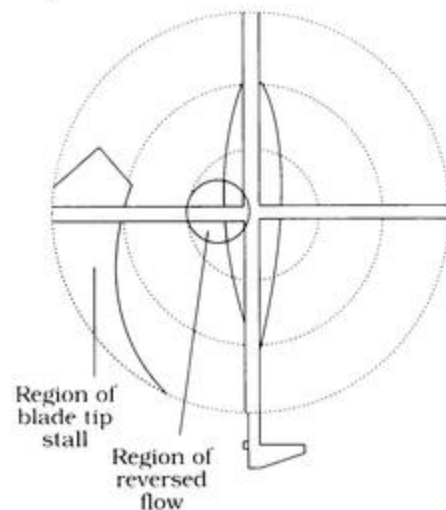

## THE CONTROLS

A helicopter requires both hands (and both feet) on the controls at all times. Helicopters are controlled in flight by three pilot “inputs”: the cyclic and collective sticks (which occupy the hands), and the rudder pedals (which are controlled by the feet of the pilot).

The cyclic controls the “attitude” of the helicopter - its direction and degree of tilt. This affects the horizontal direction and speed of flight, by adjusting the direction of thrust from the rotor. Direction of flight as controlled by the cyclic is independent of heading (the direction the helicopter is pointing); this enables a helicopter to fly forward, backward or sideways.

The collective controls the lifting and thrusting force of the rotor blades by altering their pitch - taking a bigger or smaller bite out of the air. While the helicopter is in a hover, the collective controls the vertical thrust (lift) of the helicopter. The collective is often combined with, and always used in conjunction with the engine throttle, to adjust the engine’s power to the demand of the collective.

The rudder pedals control the heading of the helicopter - the direction it points in. Using the pedals, a pilot can turn a helicopter about the axis of its rotor blades while in a hover. Using the foot pedals in combination with the cyclic control when the helicopter is in forward flight enables it to make a very tight turn.

## HOVERING

To hover a helicopter, the cyclic must be held at center, so that the helicopter does not gain airspeed in any direction. The collective controls keep the helicopter at a constant altitude, while the rudder pedals keep the helicopter pointed in one direction. Since the air is a dynamic environment, the pilot must constantly adjust these controls to maintain the hover.

When a helicopter is in a hover or in slow forward flight close to the ground, it creates an effect known as ground cushion. Air forced down by the rotors cannot escape quickly and is compressed between the helicopter and the ground. This, in turn, increases the efficiency of the helicopter’s engine and rotor blades.

### Collective Cyclic

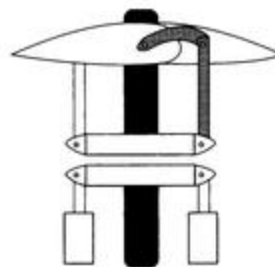

Flat Spin

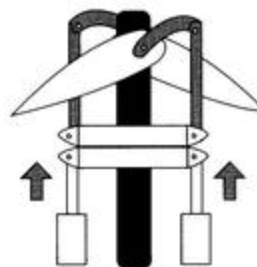

Collective Up

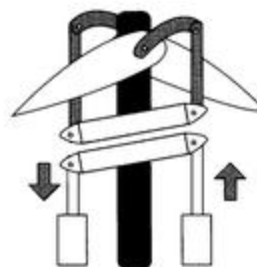

Cyclic Forward

## ACCELERATING FORWARD

To accelerate a helicopter forward from a hover, the pilot pushes the cyclic forward and pulls up on the collective. More lift is generated by the rotors as the collective is pulled up, and this lift is converted to forward thrust as the rotor (and the helicopter) is tilted forward by the collective.

As the helicopter shifts from a hover to forward flight, the helicopter settles toward the ground. This is because of a slight loss of lift as some of the helicopter's lift is converted to thrust, and as it "slips off" the ground cushion. But when the helicopter has gained some forward momentum, it also gains what is called "translational lift" - the additional lift generated by the relative motion created in horizontal flight. As the helicopter accelerates forward, the translational lift grows. However, this additional lifting efficiency is cancelled out by other effects once the helicopter reaches about 90 kts forward speed.

## LEVEL FLIGHT

When the helicopter is in straight, level flight, the cyclic controls airspeed for the most part, while the collective maintains altitude. When climbing or descending, the cyclic maintains the airspeed of the helicopter while the collective increases or decreases lift as required. Since an increase or decrease in collective often corresponds with an increase or decrease in throttle, the torque of the helicopter may increase or decrease during altitude changes. This means the rudder pedals need to be adjusted constantly to match the torque on the helicopter.

## TAKEOFF AND LANDING

Helicopter takeoff usually consists of two maneuvers - going into a hover, and forward, climbing flight. First, the pilot lifts off the ground vertically using increased throttle and collective, maintaining horizontal position as in a hover but adding more collective to pull the aircraft upward. Then, the pilot pushes the cyclic forward and pulls up on the collective to attain airspeed and climb to altitude.

Whenever possible, helicopter takeoff should be done into the wind, to prevent drift during takeoff. The pilot should also pick some reference point on the ground to keep his heading steady on during the initial acceleration.

Landing is essentially a reverse process - descending forward flight to a point above the landing point, and a gradually descending hover to the ground. All descent should be stopped when the helicopter goes into the hover.

The helicopter should not be allowed to drift horizontally while touching

down, as it could easily tip over. This could lead to the pilot and crew eating pieces of shattered rotor blade. Also, it is important that the collective be handled gently during landing, as too rapid a descent can prove dangerous. At best, a very expensive aircraft is bounced off the ground, and several vertebrae are compressed.

There may be occasion where it becomes necessary to rapidly slow down horizontal flight - a large, impassable obstacle ahead, or some other condition that might have a negative impact on the service life of the helicopter. In such a situation, care should be taken by the pilot to maintain altitude and avoid wild changes in heading. Coordinated, simultaneous use of the controls is essential.

To "put on the brakes", the pilot lets down on the collective and pulls back on the cyclic at the same time, while adjusting the rudder to prevent a wild swing in heading. As the helicopter slows to the desired speed, the pilot levels the craft by pushing forward again on the cyclic (to prevent the helicopter from settling tail-first and hitting the ground) and adjusting the collective (to maintain altitude).

## **"STEPPING ON THE BRAKES"**

---

## HELICOPTER TACTICS

One of the great handicaps of helicopter combat is that there is nowhere to hide in the sky. Anti-aircraft artillery (AAA), surface-to-air missiles, helicopters, and ground fire from small automatic weapons can swat a helicopter from the sky. With the wide proliferation of man-portable, high-tech weapons like the Stinger, SA-7 Grail, and SA-14 Gremlin missiles, the open skies are an even more dangerous place for slow-flying helicopters than before. To survive, the pilot must be able to use the unique flight characteristics of the helicopter to his advantage.

One of the most commonly used defensive maneuvers for helicopters is nap-of-the-earth (NOE) flying. In this type of flying, the helicopter follows the contour of the earth, in almost all respects becoming a ground vehicle. This type of flying demands a great deal of skill. But if the pilot doesn't hit a tree or hill, he gains a great deal more security on the battlefield from SAMs and AAA. Exposure to fire from enemy units is minimized because the helicopter is masked by the terrain for a majority of its flight, and the helicopter gains a degree of surprise.

### HELICOPTER VS. TANKS AND GROUND UNITS

The maneuverability of helicopters gives them the best of both worlds when it comes to combat with ground forces; they can use the terrain to their advantage, and then fly above it when it becomes an impediment. This ability gives the helicopter gunship the ability to ambush enemy ground forces whenever the terrain permits.

Ambush tactics for gunships date back to the Vietnam War, when Huey Cobras patrolled the Ho Chi Minh trail. The most common ambush maneuver is the "pop-up" - the helicopter masks itself behind a tree line, house, or other terrain

feature, and then “pops up” from behind its hiding place to deliver the attack. The usual minimum number of helicopters for an ambush attack is three, by NATO doctrine.

A “pop-up” is only necessary to use direct-fire weapons - weapons that require the target to be in a line of sight. With the Apache’s Hellfire laser-guided anti-tank missiles, the Apache does not even need to pop up. Another helicopter or a forward observer can designate the target with a laser, and the Apache can fire from cover.

Another weapon that offers virtually no exposure time to enemy fire is the sub-munition-type anti-armor system attack. This attack relies on a pattern of multi-purpose bomblets from exploding unguided rockets. The helicopter makes its approach shielded by the terrain, then pulls up and fires, and turns toward the rear, immediately returning to NOE flight to avoid enemy fire.

## HELICOPTER VS. HELICOPTER

The first all-helicopter dogfight on record occurred during the Iran-Iraq war, when an Iraqi Hind shot down an Iranian Cobra. Even before this event, it was widely assumed that in any large-scale conflict of the future, helicopters would meet other helicopters in air combat. The Soviets have even designed a helicopter for the single purpose of air-to-air combat operations (the Hokum).

Helicopter-to-helicopter combat tactics are an evolution of the combat tactics used first by fighter pilots in World War One. The unique maneuvering abilities of the helicopter add some considerations to the equation, but the old problems are essentially the same - how to convert velocity and altitude into a shooting position.

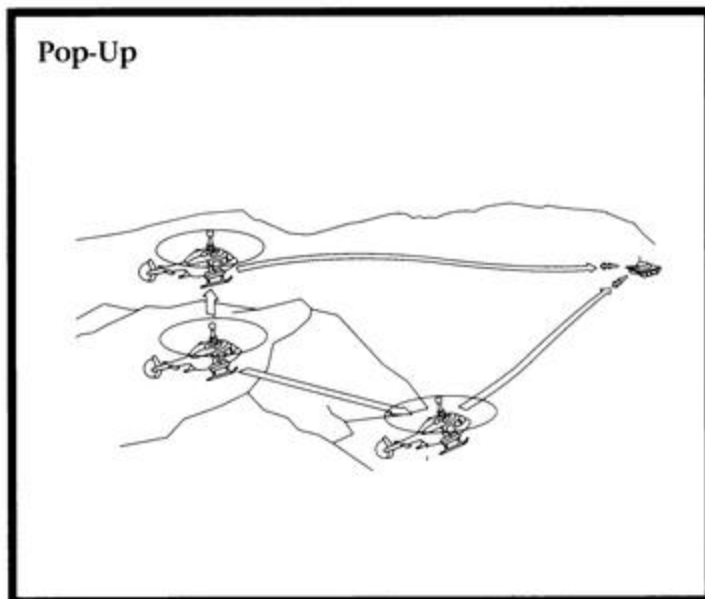

If approached from behind, the first instinct of many helicopter pilots is to brake hard to force the enemy to overshoot. To recover from an overshoot, helicopter pilots have developed a maneuver known as the “High Yo-Yo.” When the target brakes, the attacker pulls up hard to avoid an overshoot, converting airspeed into altitude, and then maneuvers to the “six-o’clock” position (directly behind the target) and drops down for the attack.

Rather than braking hard, a pilot finding himself in front of an oncoming attacker might execute a maneuver known as the “Horizontal Scissors.” In this maneuver, the pilot turns hard to one side and reduces forward velocity. The attacker is forced to turn to follow, and the pilot then turns hard in the opposite direction. The attacker is forced to reverse his turn and is forced out in front of the defender, who is now in a position to take a shot.

When faced with an attacker in close proximity, a helicopter pilot can use a maneuver developed by the U.S. Marines known as the “Side Flare Quick Stop.” The pilot pulls up hard and flares to one side, forcing the attacker to overshoot. Now behind the opponent, the pilot dives down into the six-o’clock position and has the enemy in his sights.

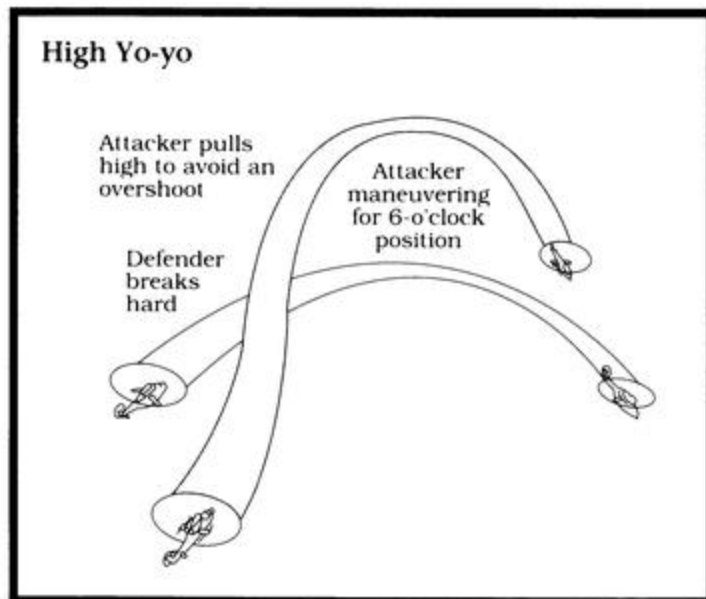

When meeting an adversary from an opposite direction, a pilot can use a maneuver known as a “Stern Conversion.” The pilot accelerates and performs a hard, banking turn called a “wing-over” (similar to the maneuver used in World War Two movies by pilots turning out of formation for an attack run). The pilot then performs a turning dive into attack position behind the enemy aircraft.



As of yet, these tactics are fairly theoretical- none have been truly proven in combat. But it is clear that pilots will use some derivative of them in any future conflict where helicopters meet over the battlefield.

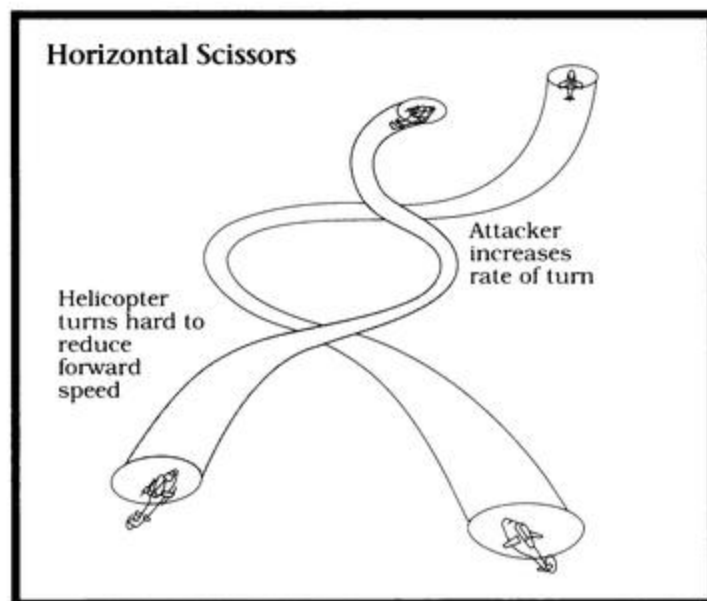

### Side Flare Quick Stop

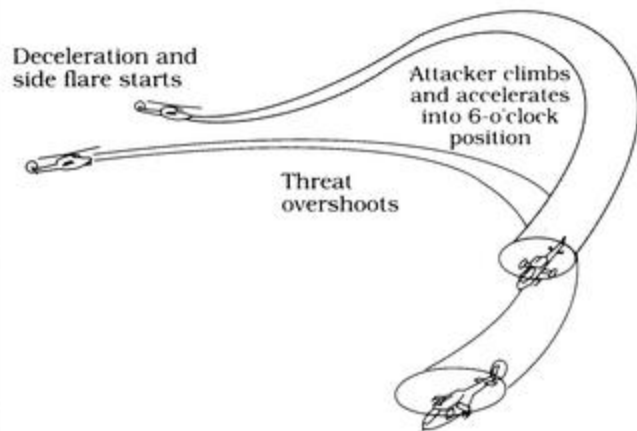

### Stern Conversion

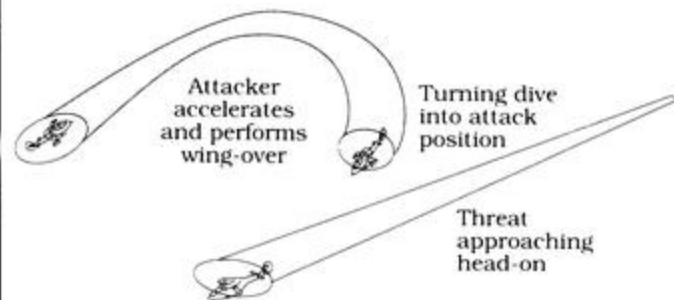



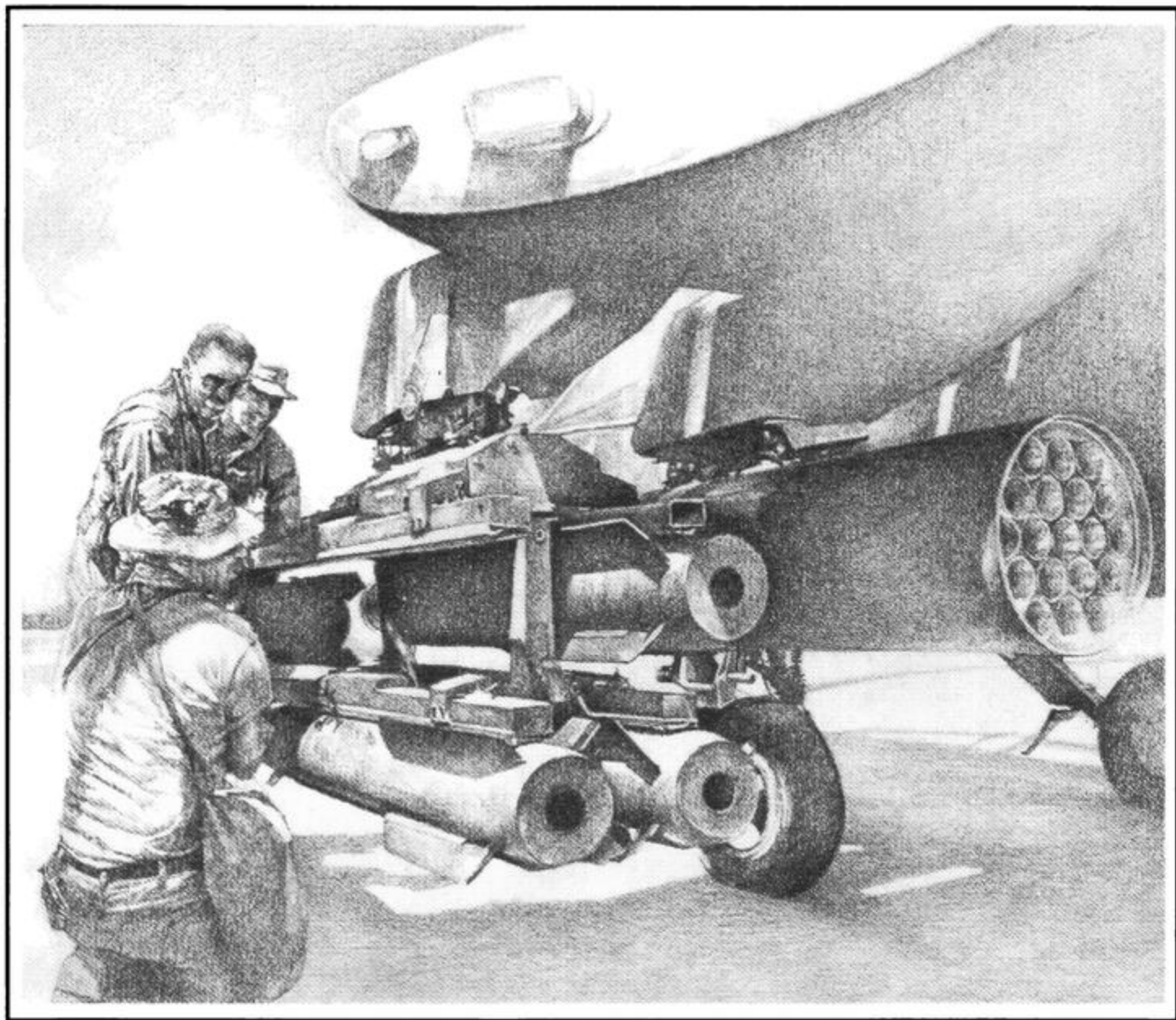

## 4. EQUIPMENT AND ORGANISATION

All are expressed in metric measurements. Metric measurements are used because most armies, including the U.S. Army, utilize the metric system. Vehicles list fully loaded combat weights. Aircraft list maximum take-off weights.

The "crew" is the normal fighting complement of the vehicle or aircraft - the men who remain aboard in combat situations.

While most all vehicles can carry passengers in some form or another, only those that are specifically built for transport, or provide a modicum of cover, list passengers. The "passengers" frequently dismount in combat.

The horsepower (hp) and type of the main engine(s). Helicopter engines are rated in "shaft horsepower" (shp). Fixed-wing aircraft engines are rated in "pounds of static thrust" (lb st). "AB" indicates afterburner capability.

For vehicles, this is maximum rated road speed in kilometers per hour (kph). For aircraft and ships, this is the maximum level speed in knots (kts) at sea level.

For helicopters, this is the vertical rate of climb from hover in feet per second (ft/sec). In most case, the maximum rate of climb is about twice this value.

The maximum attainable altitude with a nominal weapon load. The Rules of Engagement (ROE) for a Theater of Operations (TO) normally limit the maximum altitude to a much lower value.

The size and type of the main gun, if any. All guns are rifled unless "SB" (smoothbore) is indicated. For guns other than machine-guns (MG), the number of rounds carried (rds) is also indicated.

The name and type of missile carried. Aircraft and ships will also list the predominate non-missile weapons. Please note that other weapon systems could also be carried.

For aircraft, this is the maximum weapon load. More often than not, aircraft fly with less than their rated maximum load.

### DATA FORMAT

LENGTH, WIDTH, HEIGHT, WEIGHT  
AND DIAMTER

CREW/PASS

ENGINE

MAX SPEED

RATE OF CLIMB

SERVICE CEILING

MAIN GUN

MISSILES

WEAPON LOAD

## SEC GUNS

Many vehicles mount one or more secondary weapons, usually machine-guns, for local ground and air defense.

## ARMOR

Vehicle armor thickness is expressed as Heavy, Medium, Light or None.

## WHAT'S IN A NAME

You may wonder where the Soviets came up with all those weird names? Well, the names listed for most of the Soviet equipment are in reality NATO designations, not the real Soviet names. These NATO designations utilize the first letter of the unit's type to formulate the name. That's why Soviet fighter aircraft have names beginning with an "F", helicopters with an "H", air-to-air missiles with an "A", and so on.

The reason is twofold. First of all, the Russian language is not that easy to read or pronounce; secondly, the actual names are sometimes not known until years after the unit has been spotted or released - afterall, you have to call it something.

---

## YOUR HELICOPTERS AND WEAPON SYSTEMS

### AH-64A APACHE GUNSHIP

In the mid-1960s, after the AH-56 Cheyenne program failed to meet required developmental specifications (too expensive and too complex), the US Army was left without an advanced attack helicopter. At that time, the AH-1 Cobra was considered to be only a near-term step. The search continued, and the contract for the Apache was finally awarded in 1976; the first Apache entered service in 1986. The Apache is now considered to be the premier helicopter gunship.

**Avionics:** Includes a full suite of advanced communication systems, navigational flight aids and survivability systems. The target acquisition/designation sight and pilot's night vision sensor (TADS/PNVS) are the heart of the avionics package. These linked systems include an auto-focus thermal imager, laser ranger/designator and TV camera. Both are integrated into a helmet-mounted sighting system. IR signature is reduced by the Black Hole System. An airborne target handoff subsystem (ATHS) data link is also included.

Weight:	9.5 tons	Max Speed:	160 kts
Crew/Pass:	2/0	Rate of Climb:	42 ft/sec
Length:	17.8 m	Service Ceiling:	21,000 ft
Width:	5.3 m	Main Gun:	30mm, 1200 rds
Height:	4.7 m	Missiles:	Hellfire ATGM, Rockets
Rotor Diameter:	14.6 m	Weapon Load:	3.5 tons
Engine:	two 1,696 shp		

AH-64A Apache Gunship



### AH-64 Longbow Apache Gunship



### AH-64B LONGBOW APACHE GUNSHIP

A natural follow-on to the AH-64A, the Longbow Apache will feature a number of mid-life product improvements, but will be built around the new millimeter-wave radar guided Hellfire weapon system. This system includes an integrated mast-mounted sight. The MMW Hellfire is a true fire-and-forget weapon. Its seeker head will guide itself to the target; a target designator is not required. It's also longer ranged, and suffers less degradation from rain, fog and smoke than FLIR's & thermal imagers. These upgrades will make the Longbow Apache and the Comanche unbeatable stable mates.

**Avionics:** Will be an upgrade to the current Apache systems, but changes will mainly involve the target type discriminating MMW systems and related subsystems.

Weight:	9.7 tons	Max Speed:	160 kts
Crew/Pass:	2/0	Rate of Climb:	40 ft/sec
Length:	17.8 m	Service Ceiling:	21,000 ft
Width:	5.3 m	Main Gun:	30mm, 1200 rds
Height:	5.6 m	Missiles:	MMW Hellfire
Rotor Diam:	14.6 m		ATGM, Rockets
Engine:	two 1,696 shp	Weapon Load:	3.5 tons

### AH-1W SuperCobra Gunship

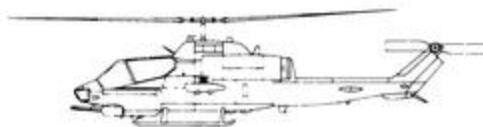

### AH-1W SUPERCOBRA GUNSHIP

The first AH-1 Cobra was built from the UH-1 Huey airframe, and saw combat in Vietnam. The Cobra has gone through many modifications and model changes. The "W" model is the latest SuperCobra iteration (it became known as the SuperCobra on or about the "S" model). While it's currently only fielded by the US Marines, the US Army is soon expected to upgrade to "W" standards.

**Avionics:** Includes a full suite of communication systems, navigational flight aids and survivability systems. The nose mounted night targeting system (NTS) includes a FLIR, laser



ranger/designator and TOW fire controls. This system is integrated with the helmet-mounted sighting system. An airborne target handoff subsystem (ATHS) data link is also included.

Weight:	7.6 tons	Max Speed:	170 kts
Crew/Pass:	2/0	Rate of Climb:	45 ft/sec
Length:	17.7 m	Service Ceiling:	14,000 ft
Width:	3.3 m	Main Gun:	20mm, 750 rds
Height:	4.3 m	Missiles:	Hellfire & TOW
Rotor Diam:	14.6 m		ATGM, Rockets
Engine:	two 1,690 shp	Weapon Load:	1.4 tons

#### AH-66A COMANCHE GUNSHIP/SCOUT HELICOPTER

In 1982 the US Army invited manufacturers to submit design concepts for its Light Helicopter Experimental (LHX) program. The original procurement called for 5,000 units to replace UH-1, AH-1, OH-58 and OH-6 airframes; this was later revised to 2,096 units (the UH-1Huey follow-on was eliminated). The LHX, now designated the AH-66A Comanche, will feature many advances in helicopter technology, including all-composite airframe construction, advanced bearingless rotor system, internal weapons bay and retractable landing gear. Stealth technologies will be employed where feasible. Its tandem cockpit seats the pilot in the front seat, as in jet aircraft.

**Avionics:** Includes the most advanced systems to date. All will be fly-by-wire technology. All systems are integrated into the wide field-of-view helmet sighting/targeting system. MFD's will dominate the console, and the architecture will be of the same generation as US Air Force's Advanced Tactical Fighter (ATF).

AH-66A Comanche Gunship/Scout Helicopter

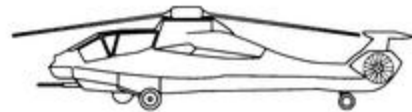

Weight:	7.5 tons	Max Speed:	170 kts
Crew/Pass:	2/0	Rate of Climb:	40 ft/sec
Length:	13.2 m	Service Ceiling:	15,000 ft
Width:	2.3 m	Main Gun:	20mm, 500 rds
Height:	3.4 m	Missiles:	Hellfire ATGM,
Rotor Diam:	11.9 m		Rockets, Stinger
Engine:	two 1,200 shp	Weapon Load:	2.5 tons

### OH-58D KIOWA WARRIOR SCOUT HELICOPTER

The first OH-58's saw service in the Vietnam War. It had been selected as the replacement for the OH-6 Cayuse. It also has seen great commercial success as the JetRanger. The Kiowa Warrior is considered to be only the near-term scout helicopter. It's scheduled to be replaced in the mid-1990s by the AH-66A Comanche. The US Army plans to field a total of 477 OH-58D's, by upgrading OH-58A models to OH-58D standards.

**Avionics:** Mast-mounted sight includes auto-focusing thermal imager, laser ranger/designator and TV camera. The airborne target handoff subsystem (ATHS) enables remote targeting for the Hellfire missile.

Weight:	2.0 tons	Max Speed:	120 kts
Crew/Pass:	2/0	Rate of Climb:	20 ft/sec
Length:	12.9 m	Service Ceiling:	12,000 ft
Width:	2.0 m	Main Gun:	None
Height:	3.9 m	Missiles:	Hellfire ATGM,
Rotor Diam:	10.7 m		Rockets, Stinger
Engine:	one 650 shp	Weapon Load:	.4 tons

OH-58D Kiowa Warrior Scout Helicopter



## UH-60K/L BLACKHAWK ASSAULT HELICOPTER

As a replacement for the UH-1 Iroquois Transport Helicopter (the famous Huey), the Blackhawk entered service in 1979. Designed primarily to transport 11 fully equipped troops, its spacious cabin enables it to also be used, without modification, for medevac, supply and command functions. The external stores support system (ESSS) can carry a significant number of weapons. The "K" & "L" models entered service in 1988.

**Avionics:** Includes a full suite of communication systems, navigational flight aids, including advanced AFCS subsystem, and survivability systems. UHF satellite communication is also available. IR signature is reduced by the hover infrared suppressor (HIRSS) system.

Weight:	10.0 tons	Max Speed:	160 kts
Crew/Pass:	3/11	Rate of Climb:	32 ft/sec
Length:	17.7 m	Service Ceiling:	19,000 ft
Width:	5.5 m	Main Gun:	None
Height:	5.1 m	Missiles:	Hellfire ATGM,
Rotor Diam:	16.4 m		Rockets, Gun Pods
Engine:	two 1,560 shp	Weapon Load:	4.6 tons

## AH-6G DEFENDER LIGHT GUNSHIP/SCOUT HELICOPTER

The original Defender dates back to the Vietnam War, where it saw action as the OH-6A Cayuse LOH (Light Observation Helicopter - "Loach"). The AH-6G is based on the commercial MD530 helicopter. A compact integrated crew station with multiple MFD's enhances this helicopter's field of view. It's designed primarily for day or night point attack and anti-armor missions, but is equally suitable for scout missions.

**Avionics:** Includes a full suite of communication systems, navigational flight aids and survivability systems. Mast-mounted sight includes FLIR, laser ranger and TOW fire controls.

UH-60K/L Blackhawk Assault Helicopter

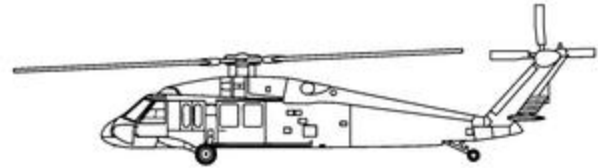

AH-6G Defender Light Gunship/Scout Helicopter



Weight: 1.4 tons                      Max Speed: 120 kts  
Crew/Pass: 2/3                        Rate of Climb: 28 ft/sec  
Length: 9.8 m                         Service Ceiling: 16,000 ft  
Width: 3.2 m                         Main Gun: 7.62mm MG  
Height: 3.0 m                         Missiles: TOW ATGM,  
Rotor Diam: 8.3 m                     Rockets  
Engine: one 650 shp                 Weapon Load: .7 tons

**M230 30mm Chaingun**

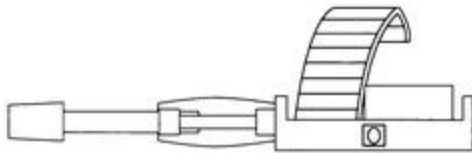

### **M230 30MM CHAINGUN**

Primary armament on the Apaches. The chaingun is a single barrelled, externally powered weapon that's driven by a simple chain mechanism. The chain literally pulls the rounds of ammunition through the gun, therefore greatly reducing the chance of a jam. The chaingun configuration is lighter than gatling guns.

Weight: 55.9 kg                      Rate-of-Fire: 625 rpmΔ9  
Aiming Mechanism: Helmet Mounted Sight or Gunner's Sight  
Primary Target: Medium armored or unprotected targets

### M197 20MM GATLING GUN

Primary armament on the SuperCobra. The M197 is a lightweight, externally powered 3-barrelled variation of the M61A1 20mm Vulcan 6-barrelled fighter aircraft weapon. It uses the gatling gun principle of rotating barrels around a common axis. This makes for a high rate-of-fire and limits jamming.

Weight: 66 kg

Rate-of-Fire: 3,000 rpm

Aiming Mechanism: Helmet Mounted Sight or Gunner's Sight

Primary Target: Lightly armored or unprotected targets

### SUU-11B/A MINIGUN POD

The minigun is a 7.62mm development of the M61A1 20mm Vulcan 6-barrelled gatling gun. It's available as a wing mounted pod weapon on the Blackhawk, SuperCobra, Kiowa Warrior or Defender, and it's also the fixed gun weapon on the Defender. It provides excellent area suppressive fire for a small cost in weight.

Weight: 147 kg, with 1,500 rds

Rate-of-Fire: 2,000/4,000 rpm

Aiming Mechanism: Direct fire along axis of flight

Primary Target: Unprotected targets

M197 20mm Gatling Gun



SUU-11B/A Minigun Pod



### GPU-2/A Gun Pod



### GPU-2/A GUN POD

The GPU-2/A is basically a M197 20mm 3-barrelled gatling gun in pod form. It's a totally self-contained unit with gun and ammunition. It even has its own rechargeable power source. All the pilot needs to do is aim and fire. It's available as a wing mounted pod weapon on the Blackhawk, SuperCobra, Kiowa Warrior or Defender.

Weight:	270 kg, with 300 rds
Rate-of-Fire:	1,500 rpm
Aiming Mechanism:	Direct fire along axis of flight
Primary Target:	Lightly armored or unprotected targets

### Viper 20mm Gatling Gun

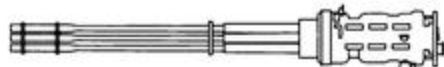

### VIPER 20MM GATLING GUN

Primary armament on the Comanche. The Viper is a lightweight 2-barrelled cannon. It's uses an all new configuration, but is still based on the gatling gun principle of rotating barrels around a common axis. It's speculated that it fires a more effective round of ammunition than the standard M197 20mm cannon round.

Weight:	50 kg
Rate-of-Fire:	2,000 rpm
Aiming Mechanism:	Helmet Mounted Sight
Primary Target:	Lightly armored or unprotected targets

### AIM-92 Stinger AAM



### AIM-92 STINGER AAM

The air launched version of the Stinger has been in operation since 1988. Based on the excellent man-portable system, this version combines a new dual color IR & UV seeker head and a reprogrammable microprocessor (RPM). The missiles are mounted in a twin missile pod system. The Stinger is a very effective lightweight missile.

Weight: 47 kg, twin launcher  
Maximum Firing Range: under 10 km  
Guidance System: IR homing  
Primary Target: short range, low-flying targets

### AIM-9R SIDEWINDER AAM

The Sidewinder missile dates back to the late 1940s, when it was first developed by the US Navy. The current model bears little resemblance to the original other than in outward appearance. It has gone through innumerable changes in its lifetime. The "R" model has an all-aspect seeker head and improved low-smoke rocket engine.

Weight: 87 kg  
Maximum Firing Range: 18 km  
Guidance System: IR homing  
Primary Target: All airborne targets

### AGM-122 SIDEARM AGM

The Sidearm system evolved out of the need to develop a low cost, lightweight anti-radar missile. Unused Sidewinder AIM-9C's were refurbished and brought up to AIM-9L/M standards, and a broadband passive radar seeker replaced the existing seeker. It will be carried by AV-8B Harriers, F-4G Phantom Wild Weasels, and helicopters.

Weight: 91 kg  
Maximum Firing Range: 15 km  
Guidance System: Passive radar homing  
Primary Target: SAM & gun control radars

AIM-9R Sidewinder AAM



AGM-122 Sidearm AGM



### AGM-65D Maverick AGM

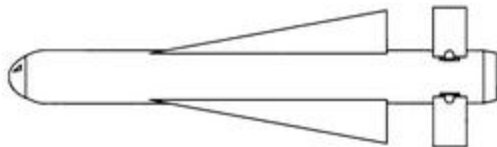

### AGM-65D MAVERICK AGM

The Maverick "D" model entered service in 1983, and was a natural follow-on to this very successful weapon. It has replaced the earlier "TV" guidance system with an imaging infrared system. The IR system has a much greater range and has ability to "see" through smoke and dust. Maverick is a true fire-and-forget weapon system.

Weight: 220 kg

Maximum Firing Range: 25 km

Guidance System: IR homing

Primary Target: Heavily armored targets & fortifications

### AGM-114A/B Hellfire AGM

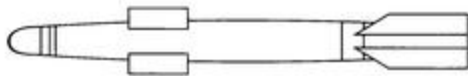

### AGM-114A/B HELLFIRE AGM

Hellfire is the US Army's latest anti-armor weapon system. The "A" model's laser seeker requires the target to be illuminated by a laser source; however, it need not be the launching helicopter. The "B" model's millimeter wave radar seeker is a true fire-and-forget weapon system. It will be carried by the Longbow Apache.

Weight: 43 kg

Maximum Firing Range: 6 km (A), 8 km (B)

Guidance System: semi-active laser (A), MMW Radar (B)

Primary Target: Heavily armored targets & fortifications

### BGM-71D TOW-2 AGM

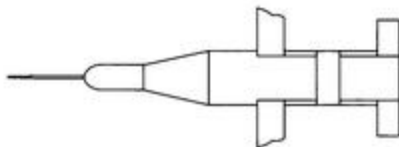

### BGM-71D TOW-2 AGM

The TOW system has been utilized as an airborne ATGM since the Vietnam war. It (SACLOS) uses semi-automatic command to line-of-sight guidance. All the operator need do is keep the cross-hairs centered on the target. Commands are transmitted to the TOW via a thin wire. The TOW-2 model has a larger, improved warhead.



Weight: 22 kg

Maximum Firing Range: 4 km

Guidance System: Command to Line-of-Sight via Wire

Primary Target: Heavily armored targets & fortifications

### HELSTREAK HVM AGM/AAM

The Helstreak High Velocity Missile (HVM) system is based on the British Starstreak SAM. It's laser guided warhead contains three highly accurate darts that independently home in on the target. This makes for a wide coverage pattern, which is important in the air-to-air role. With HUMs, exposure time is reduced.

Weight: 40 kg

Maximum Firing Range: 7 km

Guidance System: semi-active laser homing

Primary Target: Medium armored ground & air targets

### PENGUIN-3 ANTI-SHIP MISSILE

The Norwegian developed Penguin-3 anti-ship missile's modest weight (as far as anti-ship missiles go) makes it ideally suited for helicopters. The missile is aimed at a point on the surface, and it flies there under its own inertial guidance. Then, it switches on its IR homer, seeking out the heat of a ship against the cool ocean background.

Weight: 380 kg

Maximum Firing Range: 40 km

Guidance System: IR homing

Primary Target: Medium & Light Ships

Helstreak HVM AGM/AAM



Penguin-3 Anti-Ship Missile

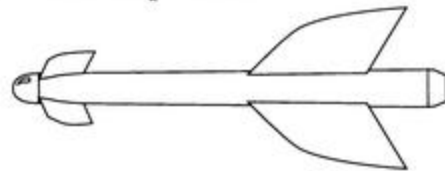

### Hydra 70 Rocket System

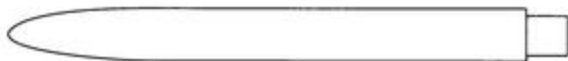

### HYDRA 70 ROCKET SYSTEM

The Hydra 70 rocket System (the 70 = 70mm, or 2.75 in) is a series of rockets each with a special-purpose warhead. The M261 has a sub-munition multipurpose warhead. The M247 has a shaped-charge warhead for use against armored targets. The M255 has a flechette warhead for use against unarmored targets or Helicopters.

Weight:	9 kg
Maximum Firing Range:	2-3 km
Guidance System:	Unguided
Primary Target:	Varies by Warhead Type

## THE GROUND AND AIR UNITS

### U.S. AND ALLIED UNITS

The friendlies and not so friendlies. These are the predominate vehicles, aircraft and ships you'll cross paths with throughout your missions. While you'll certainly come across many other units (e.g. trains, trucks, buildings, bridges, oil tanks and airfields), they're just too numerous to mention.

#### M1A1 "ABRAMS" MAIN BATTLE TANK

Unquestionably the finest tank in the field today, the M1A1 entered service in 1985. It mounts the hard-hitting German Rheinmetall 120mm smoothbore cannon (same as the German Leopard-2) backed by a sophisticated fire control system. Later versions have depleted uranium (DU) armor added to the turret and hull fronts.

Weight:	57.2 tons	Main Gun:	120mm SB, 40 rds
Crew/Pass:	4/0	Missiles:	None
Engine:	1,500 hp turbine	Sec Gun:	three MG's
Speed:	64 kph	Armor:	Heavy

#### M60A3 MAIN BATTLE TANK

The M60A3 lineage dates from the venerable M47s and M48s. An earlier model, the M60A1, saw great success in the hands of the Israelis. It's slow and tall by today's standards (not a good combination), but still possesses reasonably good armor and firepower. It's also fielded by Saudi Arabia and Egypt.

Weight:	52.6 tons	Main Gun:	105mm, 63 rds
Crew/Pass:	4/2	Missiles:	None
Engine:	750 hp diesel	Sec Gun:	two MG's
Max Speed:	48 kph	Armor:	Heavy

M1A1 "Abrams" Main Battle Tank



M60A3 Main Battle Tank



### Challenger Main Battle Tank



### CHALLENGER MAIN BATTLE TANK

The British began design work on a replacement for the Chieftain in the late 1960s. The final concept took a round-about route, as the Challenger is essentially the Iranian Shir-2. It was designed by the British, for, at that time, the Shah led Iran, but the Ayatollah had a different opinion about buying tanks from the British.

Weight:	62 tons	Main Gun:	120mm, 64 rds
Crew/Pass:	4/0	Missiles:	None
Engine:	1,200 hp diesel	Sec Gun:	two MG's
Max Speed:	56 kph	Armor:	Heavy

### AMX-30 Main Battle Tank



### AMX-30 MAIN BATTLE TANK

A French design, the AMX-30 entered production in 1966. Emphasizing the predominate European theories of the time, its design embraces speed and firepower, as armor was considered a secondary factor. The AMX-30 is also fielded by a number of middle eastern nations including Saudi Arabia and Qatar.

Weight:	36 tons	Main Gun:	105mm, 47 rds
Crew/Pass:	4/0	Missiles:	None
Engine:	720 hp multi-fuel	Sec Gun:	one cannon, one MG
Max Speed:	65 kph	Armor:	Medium

### M2A1 "Bradley" Infantry Fighting Vehicle



### M2A1 "BRADLEY" INFANTRY FIGHTING VEHICLE

The first Bradleys entered active service in 1983 after a protracted developmental period; the need was first identified in 1963. Its 25mm "Bushmaster" chaingun (a relative of the 30mm chaingun mounted on the AH-64 Apache) fires highly effective depleted uranium shells; TOW ATGM's provide the long-range hitting power.

Weight:	22.6 tons	Main Gun:	25mm, 900 rds
Crew/Pass:	3/7	Missiles:	TOW-2, 7 rds
Engine:	500 hp diesel	Sec Gun:	one MG
Speed:	66 kph	Armor:	Light

### WARRIOR MECHANIZED COMBAT VEHICLE

In the 1970s the Brit's embarked on a program to develop a mechanized combat vehicle. Somewhat austere by US standards, the Warrior lacks long-range missile capability, and has relatively simple fire control systems. But, it's relatively inexpensive, and quite sound mechanically. The Warrior entered service in 1987.

Weight:	24.5 tons	Main Gun:	30mm, 228 rds
Crew/Pass:	3/7	Missiles:	None
Engine:	550 hp diesel	Sec Gun:	one MG
Max Speed:	72 kph	Armor:	Light

### M113A3 ARMORED PERSONNEL CARRIER

The prolific M113 series was originally designed in 1956, and entered service in 1960. The A3 version entered production in 1987. The M113 is a "battle-taxi", designed to only transport the infantry into the general vicinity of the battle. Over 75,000 have been produced. It's used by many middle eastern nations.

Weight:	12.1 tons	Main Gun:	12.7mm MG
Crew/Pass:	2/10	Missiles:	None
Engine:	275 hp diesel	Sec Gun:	None
Speed:	64 kph	Armor:	Light

Warrior Mechanized Combat Vehicle



M113A3 Armored Personnel Carrier

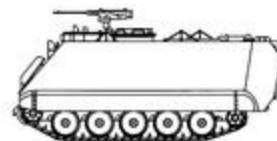

### Scorpion Reconnaissance Vehicle

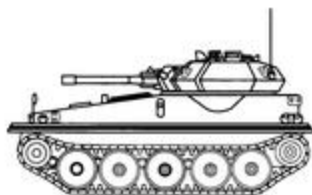

### SCORPION RECONNAISSANCE VEHICLE

Born out of a British study conducted in the 1950s, the Scorpion entered British service in 1972. Its excellent cross-county performance and high speed make for the ideal recon vehicle. The Scorpion's basic design has spawned 7 follow-on vehicles. It's also fielded by Saudi Arabia, UAE and Oman.

Weight:	8.1 tons	Main Gun:	76mm, 40 rds
Crew/Pass:	3/0	Missiles:	None
Engine:	190 hp petrol	Sec Gun:	one MG
Max Speed:	81 kph	Armor:	Light

### Scimitar Reconnaissance Vehicle



### SCIMITAR RECONNAISSANCE VEHICLE

A descendant of the Scorpion, the Scimitar followed it into service one year later. The two vehicles differ primarily only in their armament. The Scimitar is intended to provide area suppressive fire, while still having the penetrative power to engage opposing recon and light vehicles.

Weight:	7.8 tons	Main Gun:	30mm, 165 rds
Crew/Pass:	3/0	Missiles:	None
Engine:	190 hp petrol	Sec Gun:	one MG
Max Speed:	81 kph	Armor:	Light

### M901A2 ITV Anti-Tank Vehicle



### M901A2 ITV ANTI-TANK VEHICLE

The ITV (Improved TOW Vehicle) entered service in 1979 as a replacement for the M150 open-topped TOW vehicle. It's a M113A2 fitted with the Emerson M27 TOW cupola. The M27 mounts a twin launcher, TOW guidance systems and a thermal imager. The TOW's can be fired and reloaded from "under armor".

Weight:	13.0 tons	Main Gun:	None
Crew/Pass:	4/0	Missiles:	TOW-2, 12 rds
Engine:	215 hp diesel	Sec Gun:	one MG
Speed:	55 kph	Armor:	Light

## M163A2 PIVADS SELF-PROPELLED ANTI-AIRCRAFT GUN

The M163 entered service in 1968; the PIVADS (Product Improved Vulcan Air Defense System) came on to the scene in 1984. The system is an M113A1 chassis with a one-man electrically-driven turret. The 20mm gatling gun is the same as used by Air Force Fighters. Even with its high rate of fire, it's very limited.

Weight:	12.3 tons	Main Gun:	20mm, 2100 rds
Crew/Pass:	4/0	Missiles:	None
Engine:	215 hp diesel	Sec Gun:	None
Speed:	68 kph	Armor:	Light

## M998 "HUMMER" UTILITY VEHICLE

The multi-purpose "Hummer" entered service as a replacement for the famous and ubiquitous Jeep (M151). The Hummer fulfills many roles, serving as an APC, Scout, TOW platform and fire support vehicle. To date, over 100,000 have been ordered for various branches of the US Armed Forces.

Weight:	2.3 tons	Main Gun:	12.7mm MG
Crew/Pass:	2/4	Missiles:	None
Engine:	132 hp diesel	Sec Gun:	None
Max Speed:	105 kph	Armor:	None

M163A2 PIVADS Self-Propelled Anti-Aircraft Gun



M998 "Hummer" Utility Vehicle



### M109A3 Self-Propelled Artillery Vehicle

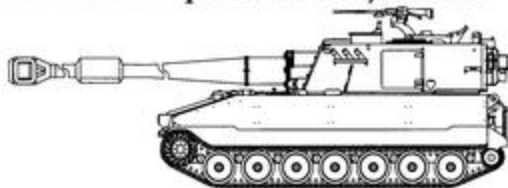

### M109A3 SELF-PROPELLED ARTILLERY VEHICLE

The M109 concept dates back to 1952, when it was born out of a study on self-propelled artillery. The lessons learned in WW2 and Korea clearly spelled the ultimate demise of static artillery. The M109 series emerged as the standard by which all other "SP's" are judged. It's fielded by most NATO members and many other nations.

Weight:	24.9 tons	Main Gun:	155mm, 36 rds
Crew/Pass:	6/0	Missiles:	None
Engine:	405 hp diesel	Sec Gun:	None
Max Speed:	56 kph	Armor:	Light

### MRLS Rocket Launcher

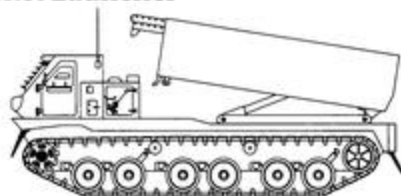

### MRLS ROCKET LAUNCHER

An international design/production program, the MRLS (Multiple Rocket Launch System) entered service in 1983. The vehicle is partially based on the M2 Bradley chassis. Its primary rocket is the M77 rocket; each warhead contains 644 dual purpose shaped-charge fragmentation bomblets.

Weight:	25.2 tons	Main Gun:	None
Crew/Pass:	3/0	Missiles:	12-227mm rockets
Engine:	500hp diesel	Sec Gun:	None
Max Speed:	64 kph	Armor:	Light



## LHA TARAWA CLASS AMPHIBIOUS ASSAULT SHIP

The first ship of this class has been in service since 1976. The LHA's are intended to combine the capabilities of LPH (helicopter carriers) and LPD (amphibious docks) into one ship. Four landing craft are carried in its deck. Its boilers are the largest ever installed on a US ship. It has a complete 300 bed hospital.

Weight:	39,400 tons	Main Gun:	3x127mm
Crew/Pass:	1014/1924	Missiles:	Sea Sparrow SAM
Engine:	70,000 hp	Aircraft:	38 helicopters,
Max Speed:	24 kts		or 20 AV-8/B Harriers

## FF KNOX CLASS FRIGATE

The Knox Class is typical of the many escort frigates built during the 1970s. The class packs a large amount of firepower onto a small frame. The Harpoon SSMs are fired from the forward mounted ASROC launcher. The originally fitted Sea Sparrow SAM system, are being replaced by the Vulcan/Phalanx 20mm system.

Weight:	4,250 tons	Main Gun:	1x127mm
Crew/Pass:	275/0	Missiles:	Harpoon SSM,
Engine:	35,000 hp		ASROC anti-sub
Max Speed:	27+ kts	Aircraft:	1 helicopter The Op

LHA Tarawa Class Amphibious Assault Ship



FF Knox Class Frigate



**T-80A Main Battle Tank**



## THE OPPOSING FORCES

### T-80A MAIN BATTLE TANK

The Soviet T-80A is thought to have entered service in 1983. It has closer developmental ties to the T-64 than to the T-72. It's considered to be only an evolutionary design, although, the gas turbine engine is a radical departure. The AT-8 Songster was added to provide long range capability, as the 125mm SB's accuracy is poor.

Weight:	42 tons	Main Gun:	125mm SB, 42 rds
Crew/Pass:	3/0	Missiles:	Songster, 2 rds
Engine:	980 hp turbine	Sec Gun:	two MG's
Speed:	75 kph	Armor:	Heavy

**T-64B Main Battle Tank**



### T-64B MAIN BATTLE TANK

The original Soviet T-64's entered service in 1967, and were plagued with autoloader and engine problems. The "B" model seems to have corrected these problems since it's still in production. It appears the T-64's were the "high-tech" option while the T-72's embodied the "bargain-basement" approach. The T-64 has never been exported.

Weight:	42 tons	Main Gun:	125mm SB, 42 rds
Crew/Pass:	3/0	Missiles:	Songster, 2 rds
Engine:	750 hp diesel	Sec Gun:	two MG's
Speed:	75 kph	Armor:	Heavy

### T-72M1 MAIN BATTLE TANK

The Soviet T-72 followed shortly after the T-64, entering service in 1971. The T-72 series has had a long career, and has been exported to many nations. Over a dozen sub-models have been identified to date. This model features enhanced turret armor, resulting in the nickname "Dolly Parton". It's also fielded by Iraq, Syria and Kuwait.

Weight:	41 tons	Main Gun:	125mm SB, 39 rds
Crew/Pass:	3/0	Missiles:	None
Engine:	780 hp diesel	Sec Gun:	two MG's
Speed:	80 kph	Armor:	Heavy

### T-62E MAIN BATTLE TANK

The Soviet T-62 was developed from the earlier T-54/T-55 series, and entered service in the early 1960s. It was the first tank to mount a smoothbore gun. Its low ballistic shape was a plus, but otherwise it was mediocre. The "E" model features add-on "horseshoe" turret armor and a laser sight. It's also fielded by Egypt, Syria and Iraq.

Weight:	41.1 tons	Main Gun:	115mm SB, 40 rds
Crew/Pass:	4/0	Missiles:	None
Engine:	580 hp diesel	Sec Gun:	two MG's
Speed:	50 kph	Armor:	Heavy

T-72M1 Main Battle Tank



T-62E Main Battle Tank



### T-55M1 Main Battle Tank



### T-55M1 MAIN BATTLE TANK

This latest version of the Soviet T-55 (the first entered service in the late 1950s) features add-on "horseshoe" turret armor and a laser sight. This is your basic "no frills" tank; simplicity is king here. The T-54/T-55's are the most widely exported of all Soviet MBT's, and is fielded by over 40 nations including Egypt, Syria and Iraq.

Weight:	37.0 tons	Main Gun:	100mm, 43 rds
Crew/Pass:	4/0	Missiles:	None
Engine:	580 hp diesel	Sec Gun:	two MG's
Speed:	50 kph	Armor:	Heavy

### Chieftain Main Battle Tank



### CHIEFTAIN MAIN BATTLE TANK

The British designed Chieftain introduced a number of innovations when it appeared in 1963. It was the first tank to mount a 120mm gun, and its highly sloped armor provided then unheard of protection. Yet still, it's slow and relatively clumsy. Iraq does field a large force, but acquired them as war booty from Iran and Kuwait.

Weight:	55 tons	Main Gun:	120mm, 64 rds
Crew/Pass:	4/0	Missiles:	None
Engine:	750 hp multi-fuel	Sec Gun:	three MG's
Speed:	48 kph	Armor:	Heavy

### BMP-2 INFANTRY FIGHTING VEHICLE

The BMP-2 is an upgrade of the Soviet BMP-1, and probably entered service around 1980. It saw the poor 73mm gun replaced with a high-velocity 30mm auto-cannon. The commander was moved from the hull to the turret, improving labor distribution and vision. The Sagger was replaced with the longer-ranged Spandrel.

Weight:	14.6 tons	Main Gun:	30mm, 500 rds
Crew/Pass:	3/7	Missiles:	Spandrel, 5 rds
Engine:	400 hp diesel	Sec Gun:	one MG
Speed:	65 kph	Armor:	Light

### BMP-1 INFANTRY FIGHTING VEHICLE

The Soviet BMP-1 caused quite a stir when it entered service in 1967. This revolutionary design was the first to combine cannon, ATGM and a full infantry squad with under armor fire capability. Its 73mm gun has poor long range accuracy, and the one-man turret is inefficient. It's also fielded by Egypt, Syria and Iraq.

Weight:	13.9 tons	Main Gun:	73mm SB, 40 rds
Crew/Pass:	3/8	Missiles:	Sagger, 5 rds
Engine:	300 hp diesel	Sec Gun:	one MG
Speed:	70 kph	Armor:	Light

### BTR-60/70/80 ARMORED PERSONNEL CARRIER

The first version of this Soviet APC, the BTR-60, entered service in 1960. These vehicles are rather mediocre in all respects. The later models did overcome a number of flaws; at least the BTR-80 (data is for this vehicle) did replace the volatile petrol engines. The BTR-60 is fielded by most of the middle eastern nations.

BMP-2 Infantry Fighting Vehicle

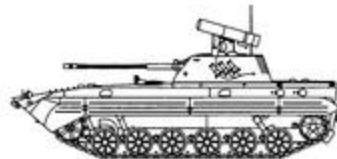

BMP-1 Infantry Fighting Vehicle



BTR-60/70/80 Armored Personnel Carrier



**MT-LB Armored Personnel Carrier**

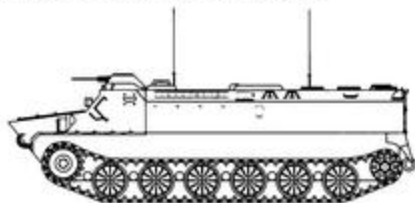

Weight:	10.5 tons	Main Gun:	14.5mm, 500 rds
Crew/Pass:	2/12	Missiles:	None
Engine:	260 hp diesel	Sec Gun:	one MG
Speed:	80 kph	Armor:	Light

#### **MT-LB ARMORED PERSONNEL CARRIER**

The Soviet MT-LB design closely followed the MT-L arctic tractor. This accounts for its excellent cross-country performance. Typical roles for the MT-LB include artillery prime mover, command post and cargo carrier. Its chassis is also the basis for a number of other vehicles.

Weight:	9.7 tons	Main Gun:	7.62mm MG
Crew/Pass:	2/10	Missiles:	None
Engine:	240 hp diesel	Sec Gun:	None
Speed:	62 kph	Armor:	Light

**EE-11 Urutu Armored Personnel Carrier**



#### **EE-11 URUTU ARMORED PERSONNEL CARRIER**

The Brazilian EE-11 first entered service in 1974. By all measures, it's a nondescript, basic every day APC. Even its wheeled configuration is much easier to maintain than a tracked arrangement. Like its cousin, the EE-9, it has been exported to many nations including Iraq.

Weight:	14 tons	Main Gun:	12.7mm MG
Crew/Pass:	2/11	Missiles:	None
Engine:	260 hp diesel	Sec Gun:	None
Speed:	105 kph	Armor:	Light

### BRDM-2 RECONNAISSANCE VEHICLE

The Soviet BRDM-2 replaced its predecessor, the BRDM-1, in the mid-1960s. Its also used as a command or an observer vehicle. It has become outclassed by more modern vehicles, and its 14.5mm gun is outdated and inadequate. It's also fielded by most of the middle eastern nations.

Weight:	7.0 tons	Main Gun:	14.5mm, 500 rds
Crew/Pass:	2/3	Missiles:	None
Engine:	140 hp petrol	Sec Gun:	one MG
Speed:	100 kph	Armor:	Light

### AML-90 RECONNAISSANCE VEHICLE

The French ordered the construction of this light recon vehicle after their successful use of the British Ferret scout car in North Africa; the AML-90 entered service in 1961. Over 5,000 AML's have been built to date in many configurations. It's fielded by Saudi Arabia, UAE and Iraq.

Weight:	5.5 tons	Main Gun:	90mm, 20 rds
Crew/Pass:	3/0	Missiles:	None
Engine:	90 hp petrol	Sec Gun:	one MG
Speed:	90 kph	Armor:	Light

### EE-9 CASCAVEL RECONNAISSANCE VEHICLE

Of Brazilian design, the EE-9 entered service in 1974. It shares many automotive components with the EE-11 APC. It now mounts a 90mm gun of Brazilian design; earlier models had 37mm guns from WW2 vintage US M3 Stuart tanks. It's very simple yet robust, and this has made it a popular export. It's fielded by Iraq.

BRDM-2 Reconnaissance Vehicle

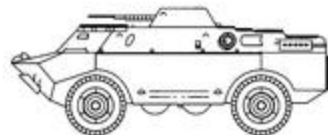

AML-90 Reconnaissance Vehicle



EE-9 Cascavel Reconnaissance Vehicle



### BRDM-3 Anti-Tank Vehicle



### 2S6 30mm/SA-19 Self-Propelled AA Vehicle



Weight:	13.4 tons	Main Gun:	90mm, 44 rds
Crew/Pass:	3/0	Missiles:	None
Engine:	212 hp diesel	Sec Gun:	two MG's
Speed:	100 kph	Armor:	Light

### BRDM-3 ANTI-TANK VEHICLE

The Soviet BRDM/Spandrel (often called the BRDM-3) was first seen in 1977. It has replaced the less capable BRDM - Sagger combination in front line service. The missiles are fired from a roof mounted launcher. Some vehicles have been seen with Spandrel/Spigot missile combination.

Weight:	7.7 tons	Main Gun:	None
Crew/Pass:	3/2	Missiles:	Spandrel, 15 rds
Engine:	140 hp petrol	Sec Gun:	None
Speed:	100 kph	Armor:	Light

### 2S6 30MM/SA-19 SELF-PROPELLED AA VEHICLE

The Soviet 2S6 was first seen in 1986 in then East Germany. It appears to be a very capable gun & missile system. Its four 30mm guns, although much longer, probably share ammo with the BMP-2. The SA-19 SAMS are IR homers and probably have a range of 10 km. It has separate search and track radars and a laser ranger.

Weight:	18.0 tons	Main Gun:	4x30mm, 2000 rds
Crew/Pass:	4/0	Missiles:	SA-19, 8 rds
Engine:	520 hp diesel	Sec Gun:	None
Speed:	60 kph	Armor:	Light



### ZSU-23(4) "SHILKA" SELF-PROPELLED AA GUN

The Soviet ZSU-23(4), or "Zoo" as it's known to western forces, entered service in 1966. Each 23mm gun has a rate-of-fire of 1000 rpm. Its single search/track J-band fire control radar has a range of 20 km. It's a very effective system when employed with missile armed systems. It's also fielded by Egypt, Syria and Iraq.

Weight:	14 tons	Main Gun:	4x23mm, 2000 rds
Crew/Pass:	4/0	Missiles:	None
Engine:	280 hp diesel	Sec Gun:	None
Speed:	44 kph	Armor:	Light

### ZSU-57(2) SELF-PROPELLED AA GUN

The first post-WW2 eastern bloc AA system, the Soviet ZSU-57(2) entered service in 1955. Its chassis is based on the T-54 tank, but with much thinner armor. Its twin 57mm guns are quite effective in a ground fire role, but have limited AA capability due to its mechanical reflex sight. It's still fielded by Egypt, Syria and Iraq.

Weight:	28.1 tons	Main Gun:	2x57mm, 316 rds
Crew/Pass:	6/0	Missiles:	None
Engine:	520 hp diesel	Sec Gun:	None
Speed:	50 kph	Armor:	Light

### SA-6 "GAINFUL" SELF-PROPELLED SAM VEHICLE

The Soviet Gainful had a long and troubled development period, finally entering service in 1967. It saw much success in the 1973 Yom Kippur War. The SA-6 missile uses semi-active radar homing guidance. Gainful works in conjunction with the "Straight-Flush" radar system. It's also fielded by Egypt, Syria and Iraq.

ZSU-23(4) "Shilka" Self-Propelled AA Gun

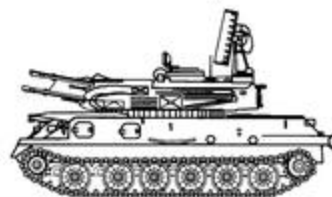

ZSU-57(2) Self-Propelled AA Gun



SA-6 "Gainful" Self-Propelled SAM Vehicle



### SA-13 "Gopher" Self-Propelled SAM Vehicle

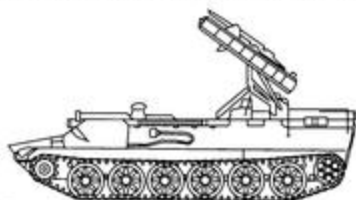

Weight:	14 tons	Main Gun:	None
Crew/Pass:	3/0	Missiles:	SA-6, 3 rds
Engine:	240 hp diesel	Sec Gun:	None
Speed:	44 kph	Armor:	Light

### SA-13 "GOPHER" SELF-PROPELLED SAM VEHICLE

The Soviet Gopher entered service in 1977. In Soviet units, it's replacing the older Gaskin on a one-for-one basis. The SA-13 missile is very capable. It uses radar only for ranging as the missile is an IR homer; it has a range of 8 km. The Gopher utilizes a variant of the MT-LB chassis. It's also fielded by Syria and Iraq.

Weight:	12.5 tons	Main Gun:	None
Crew/Pass:	3/0	Missiles:	SA-13, 4 rds
Engine:	240 hp diesel	Sec Gun:	None
Speed:	60 kph	Armor:	Light

### 2S1 S0-122 Self-Propelled Artillery Vehicle

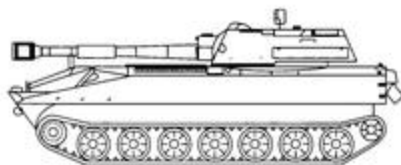

### 2S1 S0-122 SELF-PROPELLED ARTILLERY VEHICLE

The Soviet "Gvozdika" (Carnation) entered service in 1971. Outwardly, its appearance is very similar to the US M109. The Soviets were slow to adopt self-propelled artillery, continuing to rely on towed weapons. SP's are less vulnerable to counter-battery fire and provide crew protection. It's also fielded by Syria and Iraq.

Weight:	16 tons	Main Gun:	122mm, 40 rds
Crew/Pass:	4/0	Missiles:	None
Engine:	240 hp diesel	Sec Gun:	one MG
Speed:	60 kph	Armor:	Light

## S-60 ANTI-AIRCRAFT GUN

The Soviet S-60 is indicative of the many types and calibres of towed/fixed anti-aircraft guns still in use today. While limited in their flexibility, they are as accurate, or more accurate in some cases, than their self-propelled counterparts. Towed guns are fielded by many nations including most middle eastern nations.

Weight:	4.5 tons	Main Gun:	57mm, 200 rds
Crew/Pass:	7/0	Missiles:	None
Engine:	None	Sec Gun:	None
Speed:	Towed	Armor:	None

## SA-3 "GOA" LOW/MEDIUM ALTITUDE SAM SYSTEM

The Soviet Goa is obsolete by today's standards; it entered service in 1961. Aircraft counter-measures have made significant advances rendering missiles of the Goa's era almost useless. However, there's always luck. The Goa is a radar beam-rider; it works in conjunction with the "Low Blow" radar system. It's also fielded by Iraq.

Weight:	7.0 tons	Main Gun:	None
Crew/Pass:	3/0	Missiles:	SA-3, 4 rds
Engine:	None	Sec Gun:	None
Speed:	Towed	Armor:	None

S-60 Anti-Aircraft Gun

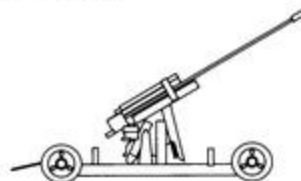

SA-3 "Goa" Low/Medium Altitude SAM System

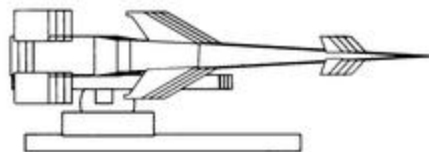

**Mi-24W "Hind-E" Gunship**

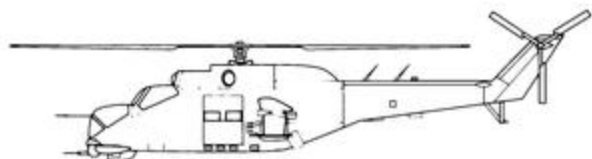

### **MI-24W "HIND-E" GUNSHIP**

The Soviet Hind first appeared in 1972. It was originally designed as a heavily armed assault helicopter, but has evolved into a capable gunship. It lacks the nap-of-the-earth maneuverability of its western counterparts. Still, it carries a heavy load, and has retained its transport capacity. It's also flown by Syria and Iraq.

Weight:	12 tons	Main Gun:	12.7mm
Crew/Pass:	2/8	Missiles:	Spiral ATGM,
Engine:	two 2,200 shp	Rockets,	SA-7 AAM
Max Speed:	295 kph	Weapon Load:	2.4 tons

**Mi-8TBK "Hip-E" Transport Helicopter**



### **MI-8TBK "HIP-E" TRANSPORT HELICOPTER**

When it first appeared in 1961, the Soviet Hip was a simple, quasi-military transport helicopter. After years of modifications, the Hip has evolved into one of the most widely accepted military helicopters with over 10,000 in use. It's described as the most heavily armed assault helicopter. It's flown by Egypt, Syria and Iraq.

Weight:	11.2 tons	Main Gun:	12.7mm
Crew/Pass:	2/28	Missiles:	Swatter ATGM,
Engine:	two 1,700 shp	Rockets	
Max Speed:	130 kts	Weapon Load:	3 tons

### MI-28 "HAVOC" GUNSHIP

Often described as the Soviet Apache, the Havoc completed pre-production testing in 1989. A true gunship, as opposed to the Hind's hybrid approach, the Havoc's narrow silhouette and tandem seating are much more suited to its role. Its high speed agility has also been enhanced by a new rotor structure.

Weight:	11.4 tons	Main Gun:	30mm, 300 rds
Crew/Pass:	2/0	Missiles:	Spiral ATGM,
Engine:	two 2,200 shp	Rockets,SA-14 AAM	
Max Speed:	165 kts	Weapon Load:	3 tons

### KA-34 "HOKUM" COMBAT HELICOPTER

By 1990, the Soviet Hokum was still in the testing stage. The exact role of the helicopter is not yet known. Kamov (Ka) helicopters have always been produced mainly for maritime roles. It may be intended for amphibious assault escort or anti-helicopter combat. It has the distinctive Kamov mark of contra-rotating rotors.

Weight:	7.5 tons	Main Gun:	30mm, 300 rds
Crew/Pass:	2/0	Missiles:	Spiral ATGM,
Engine:	two 2,200 shp	Rockets,SA-14 AAM	
Max Speed:	190 kts	Weapon Load:	2.3 tons

MI-28 "Havoc" Gunship

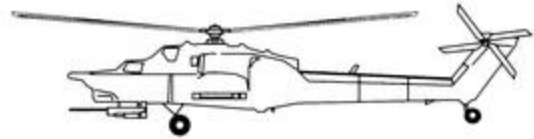

Ka-34 "Hokum" Combat Helicopter

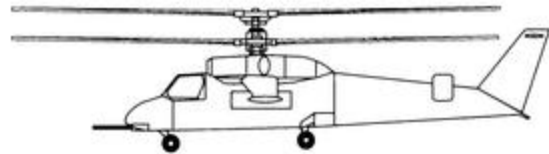

### SA-342 Gazelle Utility Helicopter

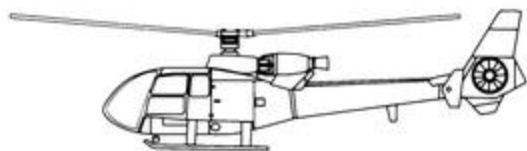

### SA-342 GAZELLE UTILITY HELICOPTER

The French Gazelle first flew in 1967. It has been utilized in many different roles, from recon, liaison and light attack, and many civilian applications. A disguised Gazelle was used in the filming of the movie Blue Thunder. It has been exported to over 41 nations including Great Britain, Egypt, Syria, Kuwait, Qatar and Iraq.

Weight:	2.1 tons	Main Gun:	None
Crew/Pass:	2/3	Missiles:	Hot ATGM,
Engine:	one 858 shp	Rockets:	SA-7 AAM
Max Speed:	140 kts	Weapon Load:	1.2 tons

### Osa-II Class Guided Missile Patrol Boat



### OSA-II CLASS GUIDED MISSILE PATROL BOAT

A replacement for the earlier Osa-I boats, the Osa-II's have been in service since 1966. A favorite of many smaller or developing nations, these boats can provide an instant navy at low cost. The SA-N-5 SAM is the navalized version of the SA-7 Grail. Said to be poor sea boats with temperamental engines.

Weight:	245 tons	Main Gun:	4x30mm
Crew/Pass:	30/0	Missiles:	Styx SSM,
Engine:	15,000 hp	Rockets:	SA-N-5 SAM
Max Speed:	140 kts	Aircraft:	None

## T-4 CLASS LANDING CRAFT

The Soviet T-4 class has been in service since 1954. It's not all that different from the landing craft that saw action during WW2.

Weight:	70 tons	Main Gun:	None
Crew/Pass:	5/50	Missiles:	None
Engine:	600 hp	Aircraft:	None
Max Speed:	10 kts	Load:	1xTank

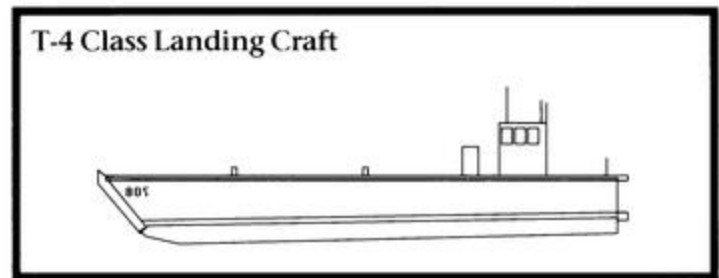





# APPENDIX

## REGIONAL DEPLOYMENTS

This area has gone through more change, in a short period of time, than any regional area in the twentieth-century. Ten years ago, no one could have predicted what is now taking place.

The Germanies are reunited and the Warsaw Pact has collapsed into a quasi-political organization; its military teeth are gone. Civil and political strife continues to escalate in the Soviet Union; this has further de-stablized the region.

The Soviet Union is a giant teetering on the brink of civil war. The old guard conservatives and the liberal progressives (right-wing moderates by our standards) are each vying for control of the country. Whoever ultimately evolves as the victor will have a far-reaching effect on the military stability of the region.

Western Europe is a very appealing target. Its consumer goods, resources, technology and labor force are hard to ignore. The Soviet Union, regardless of who wins political supremacy, has tremendous "needs" and corresponding expectations. They will get the goods one way or another.

The ex-Soviet client states are also a potential hotbed. Their new found freedom has opened the door for secularism to again rear its ugly head. There have been clashes between the Czechs and Slovaks, and the Baltic States are constantly at odds with their old master.

These internal conflicts have a habit of escalating to major proportions and drawing in other "interested parties".

Even without the non-Soviet Warsaw Pact Forces, the Soviet Union can still field over 3,000,000 men just in the land forces. Equipment includes over 50,000 tanks, 70,000 IFVs and APCs, 60,000 pieces of artillery and over 4,500 helicopters. There's no question that a portion of the equipment is obsolete,

## CENTRAL EUROPE CURRENT EVENTS

## MILITARY BALANCE

and is no longer of first line status, even by Soviet standards.

The Conventional Forces in Europe Treaty (CFE) is being touted by many as the greatest peace initiative since the Treaty of Ghent. Don't be fooled by all the rhetoric.

The CFE treaty calls for equal force limits in five broad categories: MBTs, AFVs, artillery pieces, combat aircraft and armed helicopters. These categories were arbitrarily selected because of their reference to "offensive" weapons. These limits affect the forces fielded by all treaty signors (it was signed by the 22 members of NATO and the Warsaw Pact). The immediate result of the treaty - many nations, especially the Soviet Union, must dispose of tons of military equipment.

Here's where it gets sticky. The treaty simply allows the Soviet Union to dispose of outdated equipment or to just hold or store it east of the Ural mountains. Only the countries physically located in Europe must permanently dispose of their equipment.

Of course, the USA also benefits from this apparent "loophole". Much of the US equipment must be stationed outside of Europe (the Persian Gulf region, for example) or returned to the USA. The question is, how long will it take to move it back?

## GEOGRAPHY

The area boasts of some of the most fertile ground found in the world. Parts are mountainous or heavily forested, while others are as flat and clear as the plains of Kansas. Towns and villages dot a countryside cut by many small rivers and their tributaries and crisscrossed by a highly developed road and rail net.

## THE CONFLICT

Soviet forces cross the border into the new Germany after "rescuing" Poland from Western European dominance. Economic woes and a restless, impatient populace prompt the new conservative Soviet government to use military might to quickly solve their problems. After all, the aggressive Western Europeans, backed by the equally aggressive USA, have forced them to take this action to protect their borders.

As part of the US V Corp, you must stem the Soviet tide to buy time for the mobilization of all NATO forces and the re-deployment of US forces from other regions.

The recent events in this region have been near and dear to all of our hearts. It couldn't have had a better ending if it had been written as a Hollywood movie script. Still, conflict is a way off life here.

The region has seen constant war dating back to biblical times. In addition to the most recent UN sanctioned action, the past fifty years have witnessed constant civil wars and changes of government (mostly bloody), five Arab - Israeli conflicts, regional clashes, terrorism, internal genocide and a protracted war between Iran - Iraq ... not a pretty picture when you think about it.

It remains an extremely volatile region. The coalition force that fought in Operations Desert Storm and Sabre are held together by a thread. Countries now stand beside allies whom they only recently fought as enemies. The smallest provocation could trigger a conflict between these strange bedfellows. No one has forgotten the old hatreds; there was just something else a little more pressing.

The poor Arab States hate the rich Arab States; the communist Arab States hate the monarchies; most of the Arab States hate the Israelis and the Egyptians because they don't hate the Israelis this year; and the Iranians generally hate Arabs because they're Arabs, not Persians. In addition to all this, Lebanon looks like a wasteland since just about everyone is using it as a pin cushion to work out their differences.

In spite of this, don't let anyone tell you different - oil is the focus. That's not to say that these other issues are just passing fancies. It's a matter of the have-nots wanting what the have's have or the have's just wanting more. Economics, not politics is calling the shots.

The recent conflict has left the area in a very fluid state, to say the least. In spite of the drubbing they took, the Iraqis still possess a large fighting force even if most of them are now on foot. How many men remain in uniform and how much equipment is still in Iraqi hands is unknown. They were able to save the majority of their aircraft by flying them over the border into Iran.

To the east of Iraq is Iran; not one of our closest allies by any stretch of the imagination. They appear to be perched like vultures; waiting to pounce on any opportunity. They field a 750,000 man army, but modern mechanized equipment is limited or in disrepair.

## **MILITARY BALANCE**

Another potential antagonist is Syria. They have never really cared for the rich royalty of Saudi Arabia and Kuwait. After all, Syria doesn't have much oil to speak of - see, that oil issue again! They only went along with the coalition, not being as shortsighted as Jordan, because they knew Iraq couldn't win. There was a lot of money to be had from those same rich Arabs. They have a 400,000 man army, with the equipment to back them up. While always considered a bit suspect militarily, they can't be overlooked.

With the exception of Israel and Egypt, the other Arab States field rather small forces.

## GEOGRAPHY

This is a desert region, pretty much hot, flat and generally barren. The cities are situated on the coasts, with the exception of the Tigris-Euphrates valley (the fountain of life - a bit of irony ) that runs through most of Iraq. The topography of Iran is, however, quite different. It's is fairly mountainous and water is plentiful.

## THE CONFLICT

Still licking her wounds from the last war and bitter about the UN imposed sanctions, Iraq allies with Iran (that was part of the plan all along) and launches a renewed offensive into Kuwait and Saudi Arabia. They have managed to "buy" off Syria who decides to sit this one out.

As part of the standing US Persian Gulf force, you must hold the line while the RDF is staged into the region.

## WEAPONS EFFECTIVENESS CHART

### SAM THREAT CHARACTERISTICS

<u>Weapon</u>	<u>Tracking</u>	<u>Backup Tracking</u>	<u>Guidance</u>	<u>Guidance</u>	<u>Backup Use</u>
SA-7B "Grail"	none	none	IR (C)	none	man-portable
SA-14A "Gremlin"	none	none	IR (B)	none	man-portable
SA-16A "Goblin"	none	none	IR (B+)	none	man-portable
SA-3B "Goa"	radar	visual	radar (D)	visual	fixed battery
SA-6B "Gainful"	radar	none	radar (C)	visual	vehicle mounted
SA-9B "Gaskin"	visual	none	IR (C+)	none	vehicle mounted
SA-11A "Gadfly"	radar	none	radar (B)	visual	vehicle mounted
SA-13A "Gopher"	radar	visual	IR (B)	none	vehicle mounted
SA-19A	radar	visual	laser (A)	IR (A)	vehicle mounted

#### Notes on Use

Man-portable SAMs are utilized by infantry, carried in APCs and most light vehicles, and used to defend structures. Guidance system effectiveness evaluates use against helicopters.

### AAA THREAT CHARACTERISTICS

<u>Weapon</u>	<u>Tracking</u>	<u>Tracking</u>	<u>Backup Eff</u>	<u>Use</u>
S-60 57mm	radar	visual	C	towed gun
ZU-23 23mm	visual	visual	C+	towed gun
ZSU-57(2)	visual	visual	D	vehicle system
ZSU-23(4)	radar	visual	B	vehicle system
2S6	radar	laser	A	vehicle system

#### Notes on Use

Effectiveness evaluates use against helicopters.

## HELICOPTER WEAPON SYSTEMS

<u>Weapon</u>	<u>Max Range</u>	<u>"A" Targets</u>	<u>"D" Targets</u>
30mm cannon	1,500 m	medium armored, unarmored, all aircraft	heavy armored
20mm cannon/pod	1,500 m	light armored, unarmored, all aircraft	heavy armored
Machine-gun/pod	1,000 m	unarmored	armored, aircraft
M247 rockets	2,000 m	all armored, naval	unarmored
M255 rockets	2,000 m	unarmored, helicopters	armored
M261 rockets	2,000 m	medium armored, unarmored	heavy armored
TOW-2	4,000 m	all armored, naval	unarmored
Hellfire-A	6,000 m	all armored, helicopters, naval	unarmored
Hellfire-B	8,000 m	all armored, helicopters, naval	unarmored
Sidarm	15,000 m	all radar sources	non-radar, aircraft
Maverick	25,000 m	all armored, naval	aircraft
Penguin	40,000 m	naval	land based, aircraft
Sidewinder	18,000 m	all aircraft	land/sea based
Stinger	5,000 m	most aircraft	land/sea based
Helstreak	7,000 m	medium armored, helicopters	heavy armored

### Notes on use:

Unarmored targets include most building structures.

### **General Notes:**

A: means weapon effectiveness ("Eff") or guidance is very good.

B+, B & B-: means weapon effectiveness or guidance is good.

C+, C & C-: means weapon effectiveness or guidance is fair.

D: means weapon effectiveness or guidance is poor.

---

## GLOSSARY

- AA:** Anti-aircraft. Guns designed to shoot down aircraft.
- AAA:** Anti-aircraft artillery; also referred to as “triple-A”. Used mostly to refer to heavy AA guns, but is generally synonymous with AA.
- AAM:** Air-to-air missile.
- ADF:** Automatic Direction Finding. A device to home in on transmitted navigational signals.
- AFCS:** Automatic flight control system. This device provides the control mechanisms for the autopilot and auto-hover systems.
- AGM:** Air-to-ground missile.
- AH-xx:** US designation for attack helicopters. Examples are AH-64 Apache and AH-66 Comanche.
- APC:** Armored Personnel Carrier. A tracked or wheeled vehicle that transports an infantry squad. Most carry machine-gun type weapons.
- AFV:** Armored fighting vehicle. Armored vehicle designed for front line combat.
- APR-39:** Lightweight digital threat warning system. Designed for use on helicopters and light fixed-wing aircraft. It’s optimized for NOE flight.
- APU:** Auxiliary power unit.
- ATGM:** Anti-tank guided missile. A powered missile guided by wire, radio, infrared or laser commands. TOW-2 and Hellfire are ATGMs.
- AUX Power Unit:** Auxiliary power unit. Small on-board turbine engine use to provide power to start the main engines.
- Battalion:** A military organization with two or more companies. Cavalry or helicopter battalions are often called “Squadrons”. It typically has 500 to 1,500 men.

- BMP-x:** Bronevaya Maschina Piekhota. Soviet built IFV.
- BRDM-x:** Bronevaya Razvedyvatelnaya Dozornaya Maschina. Soviet built reconnaissance vehicle.
- Brigade:** In the US Army, a military organization with two or more battalions. It typically has 3,000 to 6,000 men.
- BTR-xx:** Bronetransportr. Soviet built wheeled APC.
- CBU:** Cluster bomb unit. A bomb that bursts in to many smaller bomblets; utilized to cover a wide area.
- Chaff:** Radar decoy. Composed of thousands of different sized metal film strips. Produces varying radar reflections.
- CM:** Counter-measures. Jammers and decoys.
- CO:** The commanding officer.
- Collective:** Helicopter flight control used to “collectively” change the pitch of the main rotor blades.
- Commo:** Communications.
- Company:** A military organization with two or more platoons. Cavalry or helicopter companies are often called “Troops”. It typically has 100 to 300 men.
- CP/G:** Co-pilot/gunner. The “front seater” in helicopters with tandem seating (rear seater in the Comanche). The CP/G sits on the left in helicopters with side-by-side seating.
- Cyclic:** Helicopter flight control used to selectively change the pitch of the main rotor blades.
- Ditch:** A term for crash landing.
- FARP:** Forward arming & refueling point. A highly mobile helicopter base; it’s normally airlifted by heavy transport helicopters.
- Fast Movers:** Slang term for conventional jet aircraft.



- Flare:** A cartridge shaped source of intense heat energy. Normally launched in groups of three cartridges each with a different heat frequency.
- FLIR:** Forward looking infrared. Sighting device that “reads” the heat signature of objects.
- FLOT:** Forward line, own troops. Current designation for the line closest to the enemy.
- Flying a Desk:** Staff or command job with no flight duties.
- GPS:** Global positioning system. Satellite based navigation system.
- HEAT:** High explosive, anti-tank. A type of warhead designed to punch through steel armor. Fitted on most ATGMs.
- Heavy Section:** Helicopter flight group composed of three helicopters.
- HQ:** Head Quarters.
- HUD:** Head-up display. A piece of glass mounted on the front of the cockpit, arranged so the pilot can look forward through the glass. Important combat and flight information is reflected off the HUD. The images are superimposed over the outside world; the pilot can look through the HUD and retain the images.
- ICS:** Internal communication system. Used for communication within a helicopter.
- IFV:** Infantry fighting vehicle. A tracked vehicle that transports an infantry squad. Usually armed with small calibre cannons.
- In Constraints:** Term used to describe when a weapon is within its maximum range and target envelope.
- INS:** Inertial navigation system. A device that tracks a helicopter’s current position and desired destinations.
- IR:** Infrared. A portion of the electro-magnetic spectrum where the intensity of the signal is related to its heat signature.
- ITV:** Improved TOW vehicle. The current US TOW platform - the M901.

**Jammer:** An source of intense Infrared or radar energy used to confuse or “spoof” weapon systems.

**Ka-xx:** Helicopters designed by the Soviet Kamov Bureau.

**Klick:** Slang for kilometer.

**Knot:** A measure of horizontal motion equal to 1.1 miles per hour.

**LGB:** Laser glide bomb. A bomb guided by reflected laser energy.

**Light Section:** Helicopter flight group composed of two helicopters.

**LZ:** Landing zone.

**Mask/Unmask:** Terms used to described the use of naturally occurring objects as cover.

**MBT:** Main battle tank. A general term for “medium” and “heavy” tanks.

**MEDVAC:** Medical evacuation. The transport of wounded troops.

**MFD:** Multi-function display.

**Mi-xx:** Helicopters designed by the Soviet Mil Bureau.

**MiG-xx:** Aircraft designed by the Mikoyan-Gurevich Bureau.

**MPSM:** Multi-purpose submunition. A type of the new Hydra 70 rocket system for helicopters. The M261 rocket has 9 bomblets, or submunitions, each with its own explosive charge per rocket.

**MRLS:** Multiple rocket launching system. The newest Western artillery rocket system.

**NATO:** The North Atlantic Treaty Organization. A mutual defense treaty that includes 16 nations. They are all European based with the exception of the United States and Canada. NATO is important to the Central European Front, because it forms the basis whereby US, British and Canadian forces are stationed in Germany.

**OH-XX:** US designation for observation helicopters. Example is OH-58D Kiowa Warrior.

**Passage Point:** Safe, no fire area for flight through friendly troops.

**Platoon:** The military organization subordinate to a company. It typically has 25 to 50 men.

**Primary:** The most important mission of a flight.

**Pull Pitch:** To quickly add collective control.

**RDF:** Rapid Deployment Force. A US military force composed of “quick” move military formations. It’s intended to be used as a timely response to “hotspots” around the world.

**Reticle:** A small circular “glass” positioned over the right eye. Important combat and flight information is reflected off the reticle not unlike a HUD. The images are superimposed over the outside world; the pilot can look in any direction and retain the images.

**S2:** Battalion level intelligence officer. He finds and summarizes all information about the enemy.

**SAM:** Surface-to-air-missile.

**SEAD:** Suppression of enemy air defenses. A term used to describe a mission to destroy enemy air defense units.

**Secondary:** Targets of lesser importance than the primary.

**SOP:** Standard operating procedure. Doing it by the “book” or operating manual.

**SSM:** Surface to surface missile.

**Su-xx:** Aircraft designed by the Soviet Sukhoi Bureau.

**TADS:** Target acquisition and designation system. A device mounted on Apache helicopter that’s used to lock onto targets and to control the laser designator.

**TF:** Task Force. A battalion or squadron sized combat formation composed of mixed combat elements.

**Thermal Imager:** Similar to a FLIR, but “tuned” to objects more than structures.

**TOC:** Tactical operations center. A small command tent. Usually set up in the field.

**UH-xx:** US designation for utility helicopters. Examples is UH-60K/L. Blackhawk.

**Visiononics:** A collective term to describe all helicopter mounted sighting devices.

**VOR:** VHF omni-directional range. A radio beacon used for navigation.

**Warsaw Pact:** Formed as a counter to NATO, it was originally composed of 7 Eastern European nations. It was purely a military organization dominated by the Soviet Union. It has now dissolved into a loose political group.

**Waypoint:** An interim navigation point used in conjunction with the INS.

**Weapons Free:** A term to describe full freedom to utilize weapons against targets.

---

## DESIGNER'S NOTES

It was a bit scary when MicroProses's President, Bill Stealey, originally proposed a sequel to the highly successful Gunship. The first thought that came to mind was, how could we possibly ever top that product?

After the smelling salts were passed around, we started to kick around a few ideas. That really got the creative juices flowing, and it started to seem like a great idea - we now wished we had suggested it first.

We knew that the new simulator had to be much broader in scope than the original. It would have to include most of the neat helicopters that the Army (sorry Marines, we'll give you equal time in a later scenario) currently have in their inventory, plus the ones that are still on the drawing board. This futuristic perspective is where the 2000 in the title comes from.

We were lucky in one respect. Early on, we guessed that the Army would select the Boeing/Sikorsky version of the LHX, now designated the AH-66A Comanche. We knew if we went in that direction, we were committed, since the Army wasn't going to make its final selection until April of 1991. You know what they always say - I would rather be lucky than good.

We also wanted to expand into the operational components of multi-helicopter command. Not that flying a single helicopter can't be fun (after all, we did retain that capability), it's just that there's more to helicopter operations.

We tried to go to extremes to capture the "realism" of helicopter combat. Real action doesn't take place at 2,000 feet. It happens right next to the ground. You feel like you're going to suck the leaves off the trees as you fly by. This is why Gunship 2000 is the way that it is. We wanted you right next to the ground, weaving in and out of the canyons and between the hills just like the real pilots.

We made the "bad" guys act like bad guys, to a point - we still wanted you to have fun. After all, this is supposed to be fun, not work. We only took a few liberties with the realism.

The selection of the Persian Gulf was made, believe it or not, long before the actual conflict erupted in the region. It's not that we have a corner on crystal

## THE PLAN

balls; the region has been a hotbed for years. It was really a pretty easy call. It's lucky the real thing worked out as well as it did. We never intended to capitalize on the conflict; we're happy to strictly deal in "simulating" the actions.

The selection of Central Europe as the other theater was not an attempt at any political statement, or a prediction of impending doom and gloom. It's just that the US has a large standing force in the region, in spite of the forces transferred to the Persian Gulf. Since Gunship 2000 is a simulation, we're simulating what could happen IF, and only IF, a war did break out. The terrain found in the region also gave us the chance to show off Gunship 2000's new 3-D system.

## **THE TEAM**

Many people contributed to the making of Gunship 2000; I apologize to those not specifically mentioned. It was a team effort, and we had a great team!

Early on, we realized that we certainly couldn't utilize the 3-D system from the original Gunship and the 3-D system used in our other 3-D products, such as F-19 and F-15II, didn't provide a low level view of the terrain. We just had to design a new system.

This is where Darrell Dennies worked his magic. Darrell started on the system, now dubbed Topographical 3-D, back in February of 1990. He developed an entirely new concept to emphasize and accent the terrain where helicopters operate. The results of his efforts speak for themselves. The worlds are rich in color and depth of detail. The terrain features aren't just painted on the ground, they actually "fit" into one another as they do in real life. You can actually look through the railroad tunnel to the other side! The terrain also includes fills and "fancy" patterns on the ground and even the trees. In the campaign game, the structures destroyed in previous missions are still destroyed when you find them again; the train even moves along the railroad tracks. This system is the most complex 3-D model yet developed by MicroProse; it's probably superior to anything you've seen.

Darrell also programmed all of the "flight" related functions. He never ceased to amaze us all. One moment there could be a problem with a function or feature, and before you could bat an eye, Darrell had it corrected or added to the game. There wasn't anything Darrell couldn't fix or, somehow, squeeze into the program.

The mission generation system was developed, and for the most part designed, by Detmar Peterke. He had the patience and insight to interpret my obscure concepts into something that would work. It wasn't easy coming up with a system that would generate challenging missions that could still be fun. He developed the "action area" system that's used for selecting options. Detmar, with the help of Dave McKibbin, also "tweaked" all of the nifty animations into the game.

Detmar applied an "artist's eye" to his programming; this touch is reflected in the "look" of the game's starting and ending sequences. It's not often that you find this rare combination of talents.

Speaking of art, we couldn't have been more fortunate than to have Mike Reis as a member of the team. He spent many long, tiring hours designing and drawing all of the terrific art. The screens aren't just scanned images or touch ups of other people's art, they're original and hand drawn. His art has the look of real "live imagery"; you get the feeling that you're standing in the room or sitting in the tent. That's a lot of pixels and colors to worry about!

I know Mike often wanted to say "not you again" whenever we walked into his office with another change or idea, but he put up with us constantly critiquing or suggesting changes to the art. It's a good thing he's not thin-skinned; he probably would have "skinned" us many times over - and deservedly so.

I would be remiss in not thanking Max Remington for his terrific 3-D objects. He outdid himself again! Max is known as the "machine" around these parts. Whatever you ask for, he produces, no matter how complex or obscure. The helicopters in Gunship 2000 are the most complex objects we've ever included in a simulation; and, it's not like he had the luxury of working in an environment of unlimited capacity - he still had to make it fit.

Jeff Briggs wrote all of the music that you hear during the game. He did a great job in capturing and setting the "mood" of the game. He had to write them all as original compositions, and had to try to make them fit within the presentation of the game. This wasn't an easy task. In many cases he had only concepts to work from.

Ken Lagace along with Jim McConkey and Scott Patterson produced all of the game's sound effects. If you're lucky enough to have a Roland or AdLib sound card, you can experience the exciting sounds of helicopter flight and combat.

Iris Idokogi and her staff of thousands (just kidding, the printed material looks so good, you would think it really took that many people to develop it) are to thank for the printed material. They're the group that usually gets the least amount of time. We designers always try to wait until the last minute to finish writing the manual. Fortunately, Iris is persistent, and she doesn't let us get away with too much.

I tip my hat to the quality assurance folks; they have the toughest row to hoe. They are tasked with finding all of the things that don't work. No one is ever happy to see or hear from them, but their job is a key part of the process. Chris Taormino and the gang did a great job in keeping all of us honest.

After all that, it leaves the design element of the game - that's me. I did what all designers do at MicroProse - research & develop the scope and flow of the game, and basically annoy everyone else. I also wrote the documentation, with the help of Sean Gallagher, and developed all of the charts, tables and miscellaneous text.

One part of the game I really enjoyed doing, at least I thought so when I started it, was designing the terrain and layouts for the 6 worlds in Gunship 2000 . Darrell developed a number of tools specifically for this portion of the game that made my life easier. About 150 unique tiles were created for the worlds. Each world has over 4,000 "tiles" that are linked together to make the terrain look uniform. I started to dream about these tiles; I was smart enough not to tell my wife that she had been displaced in my dreams.

The whole idea behind the game was to capture the essence of helicopter combat, and to present it in an enjoyable, entertaining format. I believe we were successful. Only you can truly judge the results.

Jim Day

April, 1991









MicroProse Limited  
Unit 1, Hampton Road Industrial Estate, Tetbury, Gloucestershire GL8 8LD  
Tel: (0666) 504326



**This was brought to you**

**from the archives of**

**<http://retro-commodore.eu>**