

Worlds of
LEGEND
SON OF THE EMPIRE



ADVENTURERS HANDBOOK

MINDSCAPE

Contents

FOREWARD	5
INTRODUCTION	7
THE LEVEL SOLUTIONS	8
Imperia - Level 1	9
Imperia - Level 2	11
Kishiyai - Level 1	13
Kishiyai - Level 2	15
Kishiyai - Level 3	17
Iyoto - Level 1	19
Iyoto - Level 2	21
Tokjama - Level 1	23
Tokjama - Level 2	25
Guidato - Level 1	27
Guidato - Level 2	29
An Odd Shrine - Level 1	31
The Mad Monks	33
THE ROOM SOLUTIONS	34
(A) Imperia - Level 1, Room 10	35
(B) Imperia - Level 1, room 15	36
(C) Imperia - Level 1, room 32	37
(D) Imperia - Level 2, room 18	38
(E) Imperia - Level 2, room 23	39
(F) Kishiyai - Level 1, room 8	40
(G) Kishiyai - Level 1, room 22	41
(H) Kishiyai - Level 2, room 18	42
(I) Kishiyai - Level 3, room 7	43
(J) Kishiyai - Level 3, room 16	44
(K) Iyoto - Level 1, room 11	45
(L) Iyoto - Level 1, room 18	46
(M) Iyoto - Level 2, room 7	47
(N) Iyoto - Level 2, room 17	48
(O) Tokjama - Level 1, room 15	49
(P) Tokjama - Level 1, room 32	50
(Q) Tokjama - Level 2, room 9	51
(R) Tokjama - Level 2, room 20	52
(S) Guidato - Level 1, room 18	53
(T) Guidato - Level 1, room 26	54
(U) Guidato - Level 2, room 8	55
(V) Guidato - Level 2, room 20	56
(W) Odd Shrine - Level 1, room 4	57
(X) Odd Shrine - Level 1, room 10	58
(Y) Odd Shrine - Level 1, room 35	59
(Z) The Mad Monks - Level 1 (first and second visit)	61
(Z) Mad Monks - Level 1 (third and fourth visit)	62
Attacking Tetrahagal	63
Mini-facts	65
Reviews	65

FOREWARD

This document is the entire solution to 'Worlds of Legend: Son of the Empire', a fantasy role playing game (RPG) which was published by Mindscape International (UK) Ltd in 1993 for the Amiga and IBM PC. As far as I know, the Atari ST version wasn't published.

The plan was also to have each 'Worlds' disk concentrate on a different member of the party. 'Son of the Empire' was the Assassin's (Figure 1), and it would have been the Runemaster's turn next. Unfortunately, for a variety of reasons, 'Son of the Empire' was fated to be the only sequel published.



Figure 1 - This time it's war!

What you see here is the solution I created whilst playing-testing the game for Mindscape, who decided on this occasion not to commission me to write a full hintbook. Instead, they gave away my solution (without my permission) to 'The One' magazine, who serialised it across three issues without giving any due credit what-so-ever. To say I was not impressed at the time is an understatement!

Anyway, here's hoping the Handbook gives your party the assistance they require in their hour of need!

Richard Hewison, December 2008

INTRODUCTION

'Son of the Empire' is a smaller game than the original 'Legend' (13 maps compared to 23), but it is just as tricky as the solutions revealed in this handbook can testify. To compensate, there are more than double the number of genuine puzzle rooms to keep the player busy!

By far the best advice is to import a successful party from 'Legend' if you can. Your party of adventurers will retain all their experience points, their gold, the Runemaster's spellbook, his ingredients, his runes and the party's hit points will also be doubled! You can't say fairer than that! You don't have to use a save from the previous game to be able to play, but there's great satisfaction to be had from seeing your party of adventurer's reach or exceed Level 10 by the end!

Hopefully you will find this Handbook simple to follow. The maps correspond with the maps drawn by Elliot the Dragon in the game itself, but with some extra information pertaining to keys and room solutions (when required).

Unlike the preevious Handbook, there are no articles or general playing tips to be found. The game mechanics are so similar to the original that it's not worth repeating the general tips, as the majority still apply. Just go and download the 'Legend Adventurer's Handbook' instead if you want to read them!

THE LEVEL SOLUTIONS

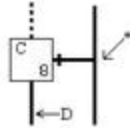

- C A key in a room
- B The room number
- ←D A key in a corridor
- A corridor
- ←+ A locked exit
- ↗ A new exit is created here
- ⋮ An exit up/down to new level

Imperia - Level 1

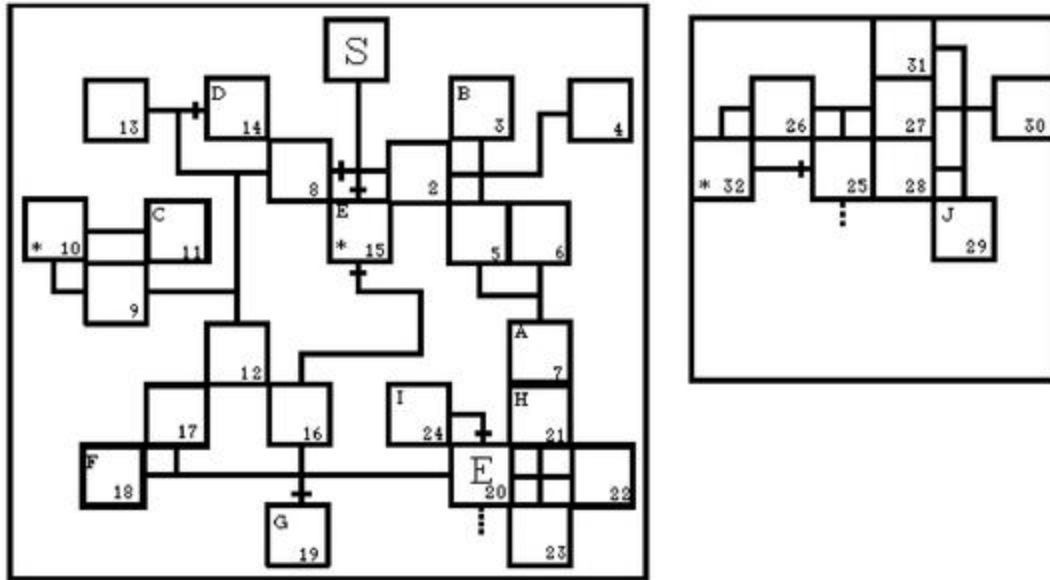

<i>Key</i>	<i>Located at</i>	<i>Opens</i>
<i>(A) RUBY</i>	<i>Room 7</i>	<i>Door, within room 3.</i>
<i>(B) EMERALD</i>	<i>Room 3</i>	<i>W door, outside room 8.</i>
<i>(C) CRYSTAL</i>	<i>Room 11</i>	<i>E door, outside room 14.</i>
<i>(D) AZURE</i>	<i>Room 14</i>	<i>S door, outside room 15.</i>
<i>(E) TOPAZ</i>	<i>Room 15</i>	<i>S door, room 15.</i>
<i>(F) GOLD</i>	<i>Room 18</i>	<i>S door, outside room 19.</i>
<i>(G) SILVER</i>	<i>Room 19</i>	<i>E door, outside room 20.</i>
<i>(H) BRONZE</i>	<i>Room 21</i>	<i>N door, room 20.</i>
<i>(I) DIAMOND</i>	<i>Room 24</i>	<i>Door, within room 20.</i>
<i>(J) IRON</i>	<i>Room 29</i>	<i>W door, room 25.</i>

The solution (NB: Rooms 25 - 32 are only accessible via level 2).

S - The Start room. A sign begins "Upon entering the Imperial citadel..." (Figure 2).



Figure 2 - Starting room in Imperia

3 - Inside this room is a button activated regeneration pad for bringing back to life dead characters. The sign says "Reforge thy bones". A locked door sits in the NE corner with a chest beyond it. You need a RUBY key to unlock the door.

10 - A simple puzzle room. See room solution (A).

15 - Another puzzle room. See room solution (B).

16 - A sign says "The deeper you travel..."

20 - The Exit room, with stairs leading to level 2 (once you've unlocked the door in the middle. It needs a DIAMOND key).

26 - A room in two halves, divided by a door blocked by spikes on the south side. In the N half you can see a lever on a pillar and a sign next to a chest in the NE region. You can't get into the N half from the S side. You must go via another route. Once in the N half (via room 25 and puzzle room 32) the lever will lower the spikes. The sign says "The Book of Skulls - A practical guide...". In the nearby chest is the book itself, which must be taken back to Auntie Sushiana.

32 - A tricky puzzle room. See room solution (C).

The solution.

S - The Start room. A sign reads "Like the upper halls..."

18 - A puzzle room with E & W halves divided by water. See room solution (D).

23 - A simple puzzle room. See room solution (E).

24 - A sign reads "Entry restricted. Beyond lie the private chambers...". Note that once you go through the W door you cannot go back E into this room.

*25 - Ti-Mann MoChun resides in here! However, if you are using an experience LEGEND party then you should have no trouble in defeating him. You cannot backtrack through the E door once in this room. Surround Mochun on all four sides and attack him with all you've got. If he picks on one of your party in particular, check that they are protected by antimage (via Amber rings) during the battle. He will often dispell the effect so keep using the ring until he is dead. Collect the DIAMOND key hidden nearby. This is used on the door in this room. Pick up the bones of Ti- Mann Mochun and keep them. Also note that a new corridor is added at (**) once you have entered this room. It will be used on your way back out of Imperia. A sign in this room begins "The evil usurper has been defeated..."*

Much later on, an Artificer will ask you for the bones. In return he will give you a very useful item, the spellsucker ring.

26 - The Exit room with stairs leading up to rooms 25 - 32 on level 1. The sign here starts "The stairs lead upwards..."

Give the Book of Skulls to Aunt Sushiana in Imperia. She will give you a key (ORNATE) to the vaults in the Keep of Kishyai.

The solution.

You must travel to the Keep of Kishyai. You will need to have a pass for the Warlord who currently occupies the keep else you won't get in. To get a valid pass you will have to fight and defeat a travelling banner belonging to the relevant Warlord, or use the one you were given at the start of the game.

(Please note that Keeps do not have the option to bribe the sentry. Towns and other visitable locations occupied by enemy armies can be entered by giving a valid pass or by bribing the sentries)

The first piece of the shard is in Kishyai.

S - Start room. A sign begins "The vaults beneath the Keep...". S door is opened with the ORNATE key given to you by Aunt Sushiana after completing Imperia (2 levels).

8 - A puzzle room. See room solution (F).

12 - In here lies a regeneration pad. "Reforge thy bones".

17 - A sign starts "Whoever designed this awful place..."

22 - Another puzzle room. See room solution (G).

25 - An Exit room that leads down to the second level. The sign reads "Below lies the thing that you seek...and also your doom!".

The solution.

You will have to go down to Level 3 to get some of the keys required for this level.

S - Start room.

2 - 2 skull tiles lie in the middle of this room. Two pillar levers sit in opposite NE and SW corners. The skull tiles and the water help to divide this room into two halves, initially NE and SW. However, by pressing the buttons on either pillar the skull tiles will swap to their opposite corners giving access to a different exit. By using these you can use all four exits, but only two are ever available at one time.

3 - A sign says "My powers are spent..."

18 - A puzzle room that looks more difficult than it eventually is! See room solution (H).

21 - Exit room. With stairs down to level 3. Also see room 24.

24 - Stairs lead to Level 3 from here as well as room 21.

28 - This room contains one of the shards. The sign says "The Shard seems to be part of a large emerald encased in a golden clasp".

Once you have the shard you will have completed Kishiyai (you have to finish Level 3 before you can get the shard here on level 2). Return to Imperia and give the shard to Aunt Sushiana. She will give you a DARK key to enter the vaults beneath the Keep of Iyoto. You will also have collected a LOST key which can be used when you fight the Mad Monks...

Kishyai - Level 3

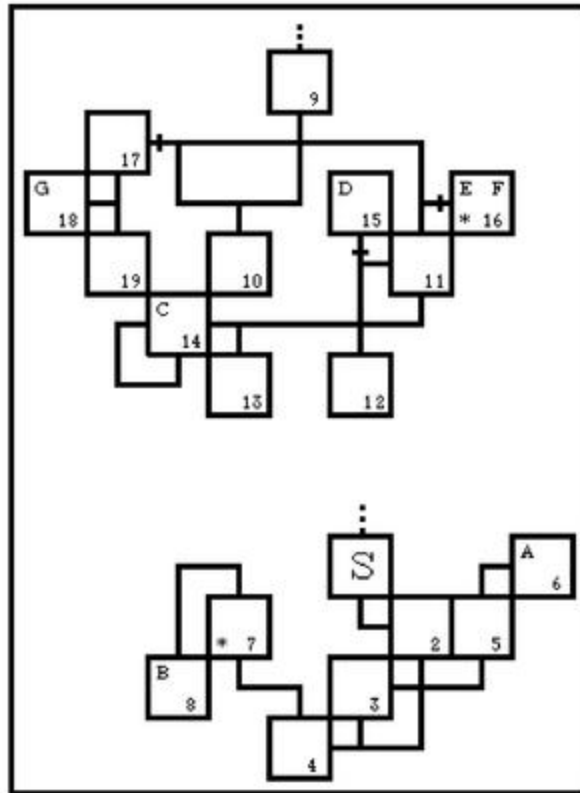

Key	Located at	Opens
(A) IRON	Room 6	N door, outside room 7.
(B) EMERALD	Room 8	W door, outside room 22 - LEVEL 2.
(C) DIAMOND	Room 14	N door, outside room 15.
(D) IRON	Room 15	E door, outside room 16.
(E) GOLD	Room 16	Door, within room 16.
(F) BRONZE	Room 16	W door, outside room 17.
(G) SILVER	Room 18	E door, outside room 25 - LEVEL 2.

The solution.

This level has two separate halves.

S - Start room. A sign says "Deeper still deeper..."

7 - A puzzle room. See room solution (I)

9 - The sign here reads "You feel you must be in the heart of the mountain..."

15 - A sign starts "Too late! They got me! Anon."

16 - A very easy puzzle room. See room solution (J).

Iyoto - Level 1

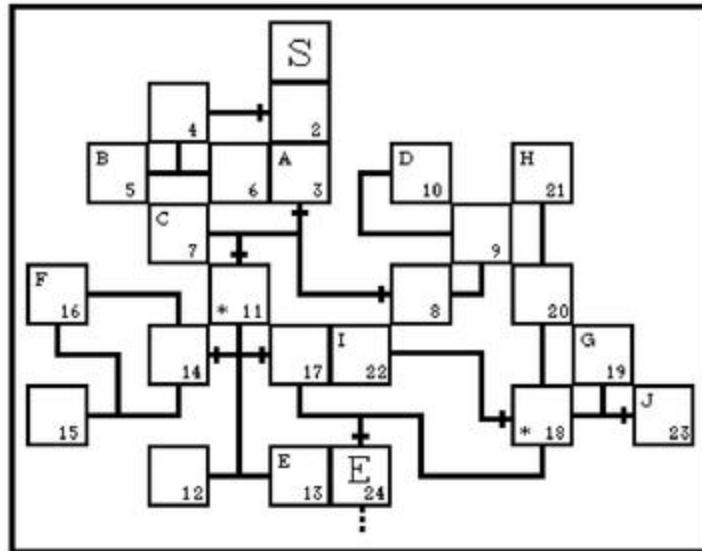

<i>Key</i>	<i>Located at</i>	<i>Opens</i>
<i>(A) RUBY</i>	<i>Room 3</i>	<i>W door, room 2.</i>
<i>(B) SILVER</i>	<i>Room 5</i>	<i>S door, room 3.</i>
<i>(C) BRONZE</i>	<i>Room 7</i>	<i>E door, outside room 8.</i>
<i>(D) TOPAZ</i>	<i>Room 10</i>	<i>S door, outside room 11.</i>
<i>(E) AZURE</i>	<i>Room 13</i>	<i>W door, outside room 14.</i>
<i>(F) DIAMOND</i>	<i>Room 16</i>	<i>E door, outside room 17</i>
<i>(G) CRYSTAL</i>	<i>Room 19</i>	<i>N door, room 18.</i>
<i>(H) EMERALD</i>	<i>Room 21</i>	<i>W door, room 18.</i>
<i>(I) IRON</i>	<i>Room 22</i>	<i>E door, outside room 23.</i>
<i>(J) GOLD</i>	<i>Room 23</i>	<i>S door, outside room 24.</i>

The solution.

S - Start room. A sign says "Castle vaults. It is hereby decreed...". Use the DARK key on the door within this room to allow you into the S side.

11 - A straightforward puzzle room. See room solution (K).

18 - This is the "leap frog" room. See room solution (L).

24 - Exit room. This room leads down to level 2.

The solution.

S - Start room. A sign says "The mark of chaos..."

7 - A puzzle room. See room solution (M).

16 - A sign starts "You feel the buzz of dormant magic..."

17 - A puzzle room. See room solution (N). This room contains the second amulet shard.

Return to Aunt Sushiana and she will give you a MOON key to get into the vaults underneath Tokjama.

Tokjama - Level 1

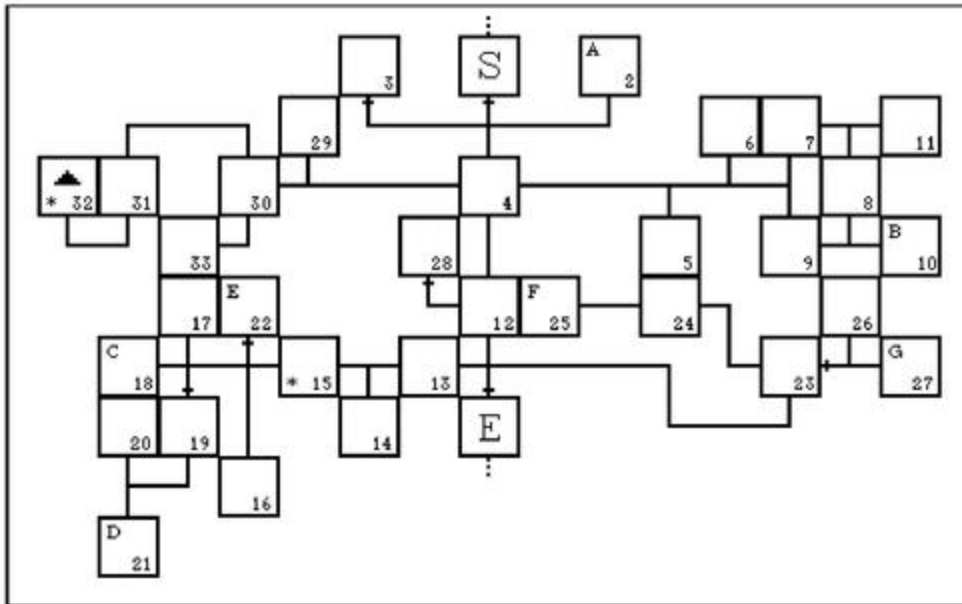

<i>Key</i>	<i>Located at</i>	<i>Opens</i>
<i>(A) DIAMOND</i>	<i>Room 2</i>	<i>N door, outside room 3.</i>
<i>(B) CRYSTAL</i>	<i>Room 10</i>	<i>Door, within room 5.</i>
<i>(C) RUBY</i>	<i>Room 18</i>	<i>S door, outside room 19.</i>
<i>(D) AZURE</i>	<i>Room 21</i>	<i>N door, outside room 22.</i>
<i>(E) SKULL</i>	<i>Room 22</i>	<i>S door, outside Exit room.</i>
<i>(F) EMERALD</i>	<i>Room 25</i>	<i>E Door, room 23.</i>
<i>(G) SKULL</i>	<i>Room 27</i>	<i>Door, within Exit room.</i>

The solution.

S - Start room. A sign says "Whoever built this dungeon...". Two S doors. One won't budge (ignore it). The other is opened by the MOON key given to you by Aunt Sushiana after delivering the 2nd Amulet Shard).

Rooms 3, 5 and 28 each contain levers that control the exits that are available from room 4. Imagine two connected corridors shaped like an L. Each time a lever is pulled the L will rotate around room 4 in a clockwise or an anti-clockwise direction, taking away some available exits and adding others as a result. Room 4 actually has all 4 available exits (N,S,E,W) but they are not all available at the same time. By experimenting you should be able to create a S exit from room 4 at the expense of the N exit. You can get the N exit back by pulling levers later.

3 - A sign says "Security Level A". There is a pillar lever here, and four skull tiles in each corner of the room.

4 - This room is affected by the levers. It begins with a N/S corridor between the Start room and room 4, and an E exit.

5 - A sign says "Security Level B". There are two pillar levers in here, beyond a locked door which needs a CRYSTAL key. Again, these levers affect the exits from room 4.

15 - A puzzle room. See room solution (O).

28 - This room can only be reached once Level 2 has been completed. Within is a sign that says "The power of the stone should not be played with, foolish mortals!". Another lever is in here. Pushing it three times should allow a S and W exit from room 4. Follow the new W exit.

32 - Another puzzle room which contains the 3rd Amulet Shard. See room solution (P).

The solution.

S - Start room.

4 - The door within this room needs a RUBY key.

7 - The door within this room needs a CRYSTAL key.

9 - This is a dangerous puzzle room that fires out damaging spells. See room solution (Q).

14 - A sign begins "The grave contains the charred remains of a Mantric...". You will also find your third LOST key in here.

20 - Another puzzle room. See room solution (R). This room contains the GOLD key needed on level 1.

The solution.

S - Start room. A sign begins "As the war rages, it becomes clear that the Empire will soon fall...". The S door is opened with the UNKEY.

5 - This is one of a couple of similar rooms on this level that are divided into two diagonal halves by water.

11 - There are two locked doors in this room protecting chests. IRON and BRONZE keys are required.

18 - Puzzle room. See room solution (S).

26 - Another puzzle room. See room solution (T).

27 - A sign says "Despite the evil-looking carvings on the pillars...".

Guidato - Level 2

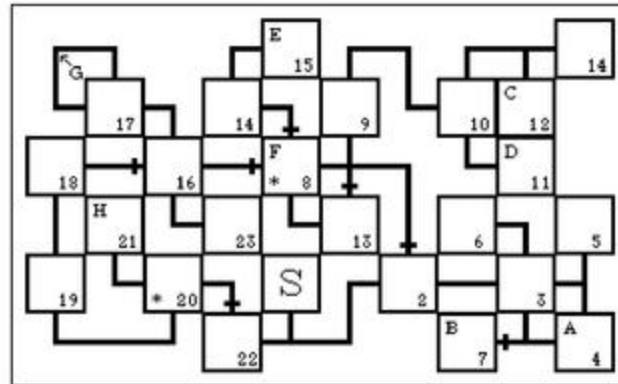

<i>Key</i>	<i>Located at</i>	<i>Opens</i>
<i>(A) SILVER</i>	<i>Room 4</i>	<i>W door, outside room 7.</i>
<i>(B) CRYSTAL</i>	<i>Room 7</i>	<i>N door, room 2.</i>
<i>(C) TOPAZ</i>	<i>Room 12</i>	<i>Door, within room 11.</i>
<i>(D) EMERALD</i>	<i>Room 11</i>	<i>S door, outside room 13.</i>
<i>(E) RUBY</i>	<i>Room 15</i>	<i>S door, outside room 8.</i>
<i>(F) IRON</i>	<i>Room 8</i>	<i>W door, room 8.</i>
<i>(G) GOLD</i>	<i>Corridor</i>	<i>W door, room 16.</i>
<i>(H) AZURE</i>	<i>Room 21</i>	<i>S door, outside room 22.</i>

The solution.

S - Start room. The sign here reads "The Eternal Champion has visited our world before..."

8 - A puzzle room. See room solution (U).

11 - The door within this room needs a TOPAZ key.

20 - Another puzzle room. See room solution (V).

22 - In here lies the fourth and final Amulet Shard. The sign nearby says "Bring them all and make them one. Invoke the Gods so HE may come."

Once you have escaped from Guidato, head back to Aunt Sushiana and give her the final Amulet Shard. In return, she will re-unite the four shards and give you the Amulet. She will instruct you to take it to the Odd Shrine so that the Eternal Champion can at last be summoned!

An Odd Shrine - Level 1

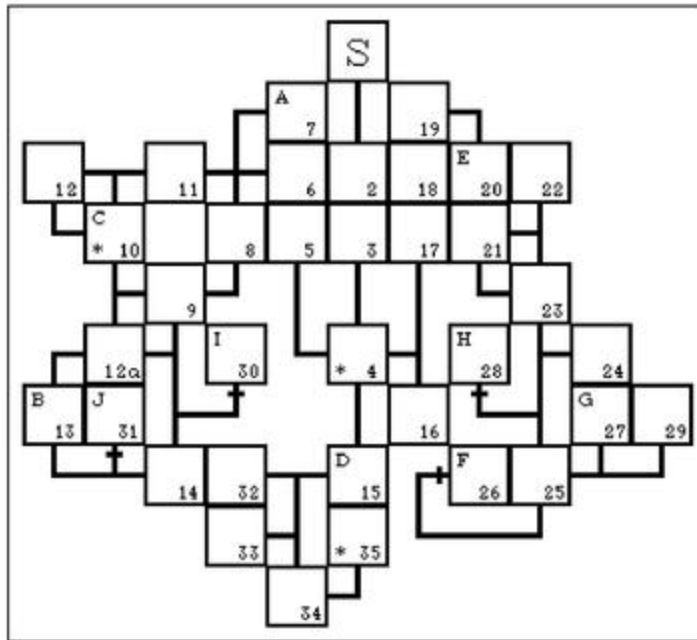

<i>Key</i>	<i>Located at</i>	<i>Opens</i>
<i>(A) CRYSTAL</i>	<i>Room 7</i>	<i>E door, outside room 26.</i>
<i>(B) DIAMOND</i>	<i>Room 13</i>	<i>Door, within room 10.</i>
<i>(C) ORNATE</i>	<i>Room 10</i>	<i>Door, within room 15.</i>
<i>(D) SKULL</i>	<i>Room 15</i>	<i>Door, within room 15.</i>
<i>(E) EMERALD</i>	<i>Room 20</i>	<i>N door, outside room 31.</i>
<i>(F) SILVER</i>	<i>Room 26</i>	<i>N door, outside room 30.</i>
<i>(G) GOLD</i>	<i>Room 27</i>	<i>N door, outside room 28.</i>
<i>(H) DARK</i>	<i>Room 28</i>	<i>Door, within room 15.</i>
<i>(I) MOON</i>	<i>Room 30</i>	<i>Door, within room 15.</i>
<i>(J) UNKEY</i>	<i>Room 31</i>	<i>Door, within room 15.</i>

The solution.

Summoning the Eternal Champion has unleashed a nightmare on the land! You have been tricked into releasing the evil Tetrahagael from his imprisonment! You must go back to Aunt Sushiana for advice on what to do. She will reveal that the demon can only be slain with an Eternal Blade, and the only way to get one is to first destroy one of the Drune Lords and take a Drune ring that will give access to the Odd Shrine. To do this you must take on the new evil banner that roams the land. Mystic weapons will do most damage to a Drune Lord (so use Make Weapon spells to arm yourselves). Once you have the Drune ring, leave the battle. You WON'T loose your horses this time.

Take the Drune ring to the Odd Shrine and gain entry. Note that the Drune ring has staggering properties. If you use it the character will have an enormous boost to their AC (around -30 I think!).

S - Start room. The sign begins "Although you know that you've never been here before..."

4 - A puzzle room. See room solution (W).

10 - Another puzzle room. See room solution (X).

15 - Five locked doors are found in this room. They need ORNATE, DARK, MOON, SKULL and UNKEY keys to get through to the SW exit. You will have to come back to this room a couple of times at least before you can finish it.

31 - A sign says "The Great One will return..."

35 - The sign here reads "Herein doth lie the Daemonslayer! Behold the Eternal Blade!". In the chest is the Eternal Blade, but to get it you must follow room solution (Y).

Only the Assassin can use the Blade, so ensure he can use teleport to get behind Tetrahagael a.s.a.p. Using moon rings on the others and getting them to surround the Demon is also a good idea. The Runemaster can dispel, disrupt and paralyze any of the other monsters so that the attack on Tetrahagael is not disturbed too often.

THE END

Once you have destroyed (or rather, banished) Tetrahagael, the end game messages and other screens will appear. You don't have to kill all of the monsters in the army to succeed. Congratulations! You've won!

The Mad Monks

The solution.

By using the Fight Monks option when trying to Train Levels, you can get free level boosts for all currently alive characters if you can survive the monks onslaught and get back out again.



Also, scattered throughout the game are four LOST keys. Each one opens the door found in the first level of the Mad Monks. Behind the door will be a different room each time you visit them. (You must leave and return before the next room is available).

Each room behind the door is usually a puzzle room of some description. The reward for getting through the puzzle room is to go down the stairs and take an invaluable object, which is always guarded by a couple of strong monsters. The objects are as follows:























<i>Visit</i>	<i>Item</i>	<i>Used by (suggested)</i>
1	Occam's razor	Assassin
2	Sword of submission	Berserker
3	Strike Staff	Runemaster
4	Sword of dissolution	Troubadour

If any characters die on this level, don't worry. They will be resurrected by the Monks when you leave. The only negative aspect of dying in the Monks domain is the loss of luck points inflicted when characters die. Of course, having less than four characters can prove to make things difficult down there, so if you can resurrect them with Chaos helms or whatever, do so.

See room solution (Z) for details on how to solve the puzzle room on your 2nd and 4th visit.

THE ROOM SOLUTIONS

Room solution key guide

 Exit	 Floor spikes	 Grille	 Floor rune
 Water	 Chest	 Pillar	 Floor rune
 Pillar lever	 Column	 Locked door	 Floor rune
 Pillar button	 Furniture	 Skull tile	 Floor rune
 Floor switch	 Fountain	 Floor tile	 Floor rune
 Teleport pad	 Fire		

(B) Imperia - Level 1, room 15

The aim of this room is to get across the water to reach the S exit. Again this is a very simple room to solve.

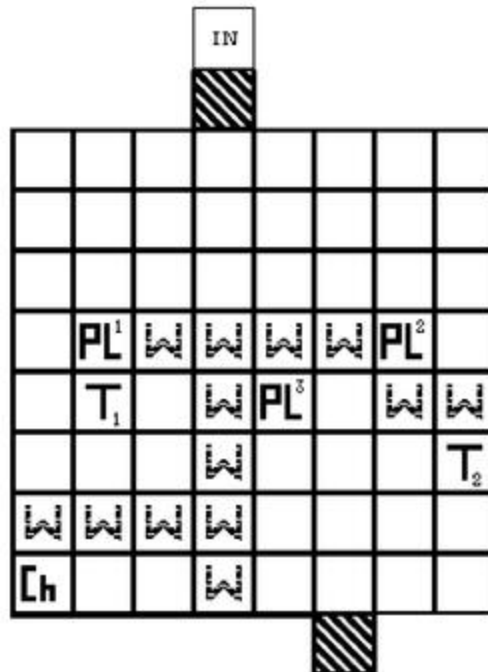

- (1) Stand 'A' on T1.
- (2) Get 'B' to push PL2. This will turn PL1 around to face S.
- (3) Get 'A' to push PL1. As a result, 'A' is teleported to T2.
- (4) Get 'A' to push PL3. Some of the water tiles turn into skull floor tiles.
- (5) 'A' can now walk to the SE chest and take the TOPAZ key.

(C) Imperia - Level 1, room 32

As soon as the party enters this room from the E door, they are each teleported to a different Teleport pad in the E half of the room. They will be attacked by the monsters who reside here and these must be destroyed before you can continue.

The aim of this room is to reach the N exit.

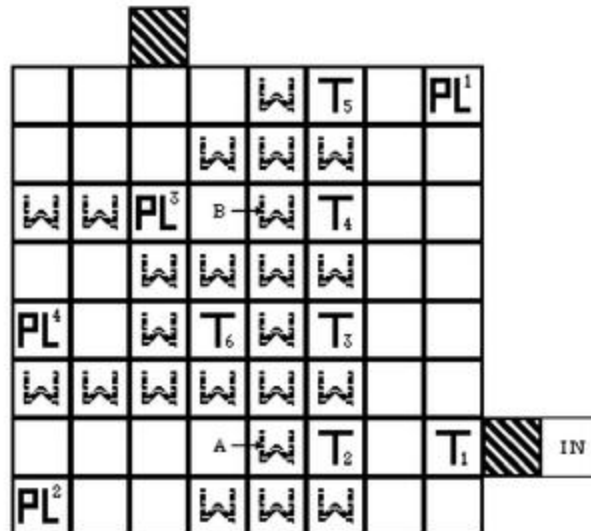

- (1) Each lever in this room creates a path to the next lever, so you must first push PL1.
- (2) To move on and off the teleport pads in this room, you must always have another character standing on the next logical pad. For example, to stand a character on T2, you must have someone on T5 then stand someone else on T4. T5 can now be vacated. T3 must now be occupied before the character can stand on T2.
- (3) Now send a character across to PL2 and push it.
- (4) PL3 gives access to the middle Teleport pad (T6) and isolates the character standing at PL2.
- (4) You must experiment to get the following situation: you need one character standing on T3, one on T4, one on T5 and the last on the skull tile between T3 and T6. Get the latter character to step onto T6 to be teleported to PL4.
- (5) Push PL4. You can now leave via the N exit.

(D) Imperia - Level 2, room 18

The objective here is to reach the W exit.

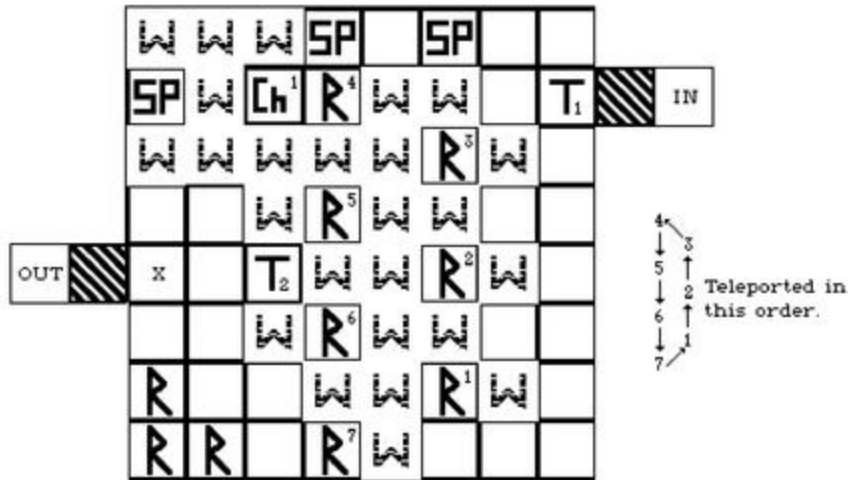

- (1) There are a few monsters in this room. As soon as you step in you trigger off the shooting pillars that fire teleport missiles at the floor runes.
- (2) Destroy the monsters. Now stand 'A' on Floor rune 1. He will be rapidly teleported between 1-2-3-4-5-6-7 and back to 1 again. This will continue indefinitely unless blocked.
- (3) Stand 'B' on Floor rune 1. 'A' and 'B' will end up standing on runes 5 & 6.
- (4) Stand 'C' on Floor rune 1. 'C' will end up on rune 4.
- (5) 'C' can reach and open the chest nearby. Get the EMERALD key.
- (6) Walk 'A' to point 'X'. This will shut off the shooting pillars. 'B' can unlock the door with the key and exit the room.
- (7) When you come back through this room T2 reactivates the W shooting pillar which will fire and trigger off the others. Stand 'A' on R7 and 'B' on T2. When the character is teleported around get him to step off R1 and reach the E exit.

(F) Kishyai - Level 1, room 8

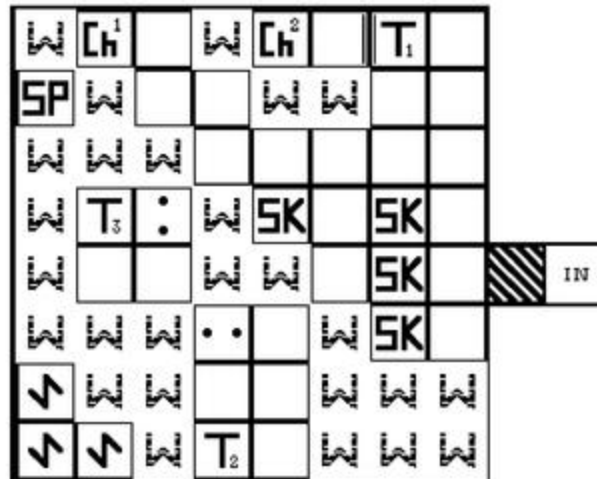

(1) The shooting pillar fires a continuous stream at the SW floor runes, moving the skull tile in the middle of the room in a clockwise direction. T1 will teleport characters back to the skull tiles near the entrance.

(2) Get 'A' to stand on the moving skull tile to be able to reach T2. Walk to T2. This will turn off the nearest spikes.

(3) Step onto the moving skull tile again to reach T3. Stepping on T3 will disengage the next spikes. 'A' should open CH1 and get the GOLD key.

(4) Use the moving skull tile again should get 'A' back to the other side. With the three others on the Skull tiles, step 'A' on T1 and unlock the door with the key. Open the chest beyond the door and take the SILVER key.

You MUST have all four characters alive to complete this room.

(H) Kishyai - Level 2, room 18

You can be attacked by wandering monsters here. The aim of this room is to reach the E exit.

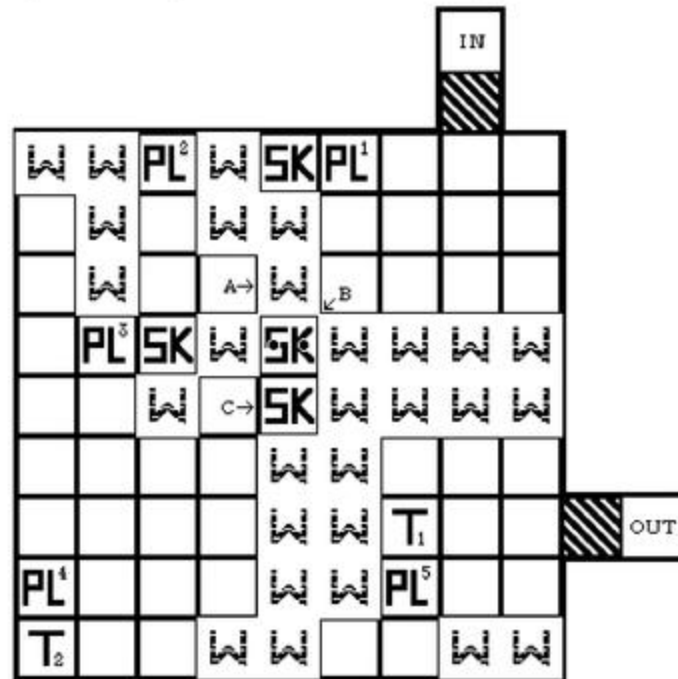

- (1) Push PL1 twice. The skull tile next to it moves S each time you push the lever.
- (2) Send 'A' to PL2. Pushing PL2 will turn off the spikes on the skull tile.
- (3) You can now reach PL3 and PL4. Stand 'B' by PL3 and 'C' by PL4. Stand another near to the door you entered the room by.
- (4) Push PL3 to move SKc once E.
- (5) Push PL4 to move SKb once S.
- (6) Push PL1 to move SKa once S.
- (7) Push PL3 once to move SKc E.
- (8) Push PL4 four times, then push PL1 four times. A character can now walk to PL5.
- (9) Push PL5 four times. Now the character left near the entrance door can reach T1 and exit.

(I) Kjshtyai - Level 3, room 7

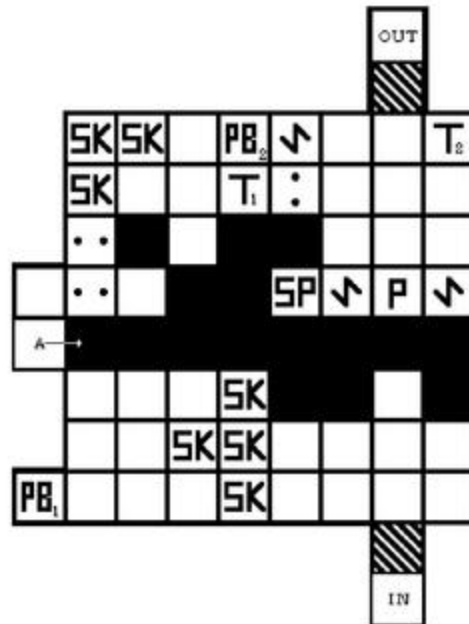

(1) PB1 (green) creates a new T3 at pos A. T3 will teleport a character back to the 4 south side skull tiles. Note that only 3 of the 4 tiles require occupation to allow a character to step onto T3 without being teleported back to the skull tiles.

(2) Stand the Runemaster on T3. Cast Missile Damage at the floor rune next to PB2 on the N side. The shooting pillar fires at the floor runes to the E. The first set of spikes will disengage. Stand the Runemaster where the spikes used to be. He is teleported beyond the second set of spikes.

(3) Use the Runemaster to cast Missile Teleport on the other remaining characters, or use Cloud potions or cloud rings. Teleport each character onto the spot where the first set of spikes used to be and they will be teleported to beyond the second set onto the skull tiles.

(4) With the N side skull tiles all occupied, walk the Runemaster onto T1 which is by PB2. Press PB2 (red). This removes the pillar near to the shooting pillar.

(5) The Runemaster must hit the rune next to PB2 with a damage spell. If the NE area is full of monsters, try casting a nuke style damage spell to destroy them and hit the floor rune. By hitting the floor rune the shooting pillar fires and hits the second floor rune to its E, removing the second set of spikes by T1.

(6) You can now leave the room by the N exit. On the way back, teleport pad T2 will take you back to the S side.

(J) Kishyari - Level 3, room 16

This room is very simple to solve. Anyone who can't solve this one on their own couldn't have got this far on their own!

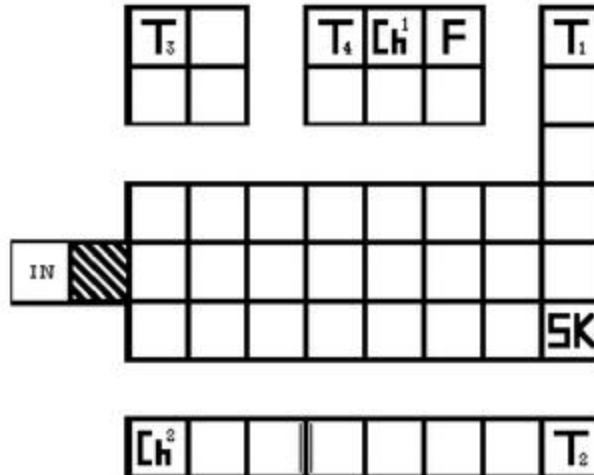

(1) Stand 'A' on the skull tile. Now stand 'B' on T1. 'B' is teleported to T2.

(2) Stand 'C' on T1. 'C' is teleported to T3. Stand 'D' on T1. 'D' is teleported to T4. Open the chest and take the GOLD key. Give the key to 'B' on T2.

(3) 'B' unlocks the door, opens the chest and gets the BRONZE key.

Simple!

(K) Iyoto - Level 1, room 11

Again, this room is short and simple to solve.

The aim is to reach the S exit.

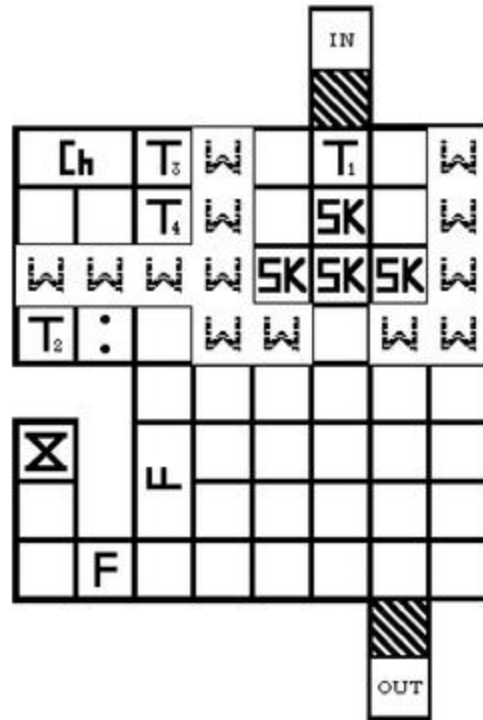

- (1) Move 'A' onto T1. 'A' is teleported between T2 and T3 continuously.
- (2) Get the Runemaster to cast Missile Dispell Paralyze Teleport at floor rune T3 to catch 'A' on T3. Continue trying until this happens.
- (3) Teleport 'A' to the front of the long chest, where 'A' can open it and take the RUBY key once 'A' has recovered from the effects of the spell.
- (4) Use the RUBY key to open the S door.

(L) Iyoto - Level 1, room 18

The sign in this room says "Do you feel like a game of leap frog?". This is a clue as to what to do in this room. You must reach the W exit (C).

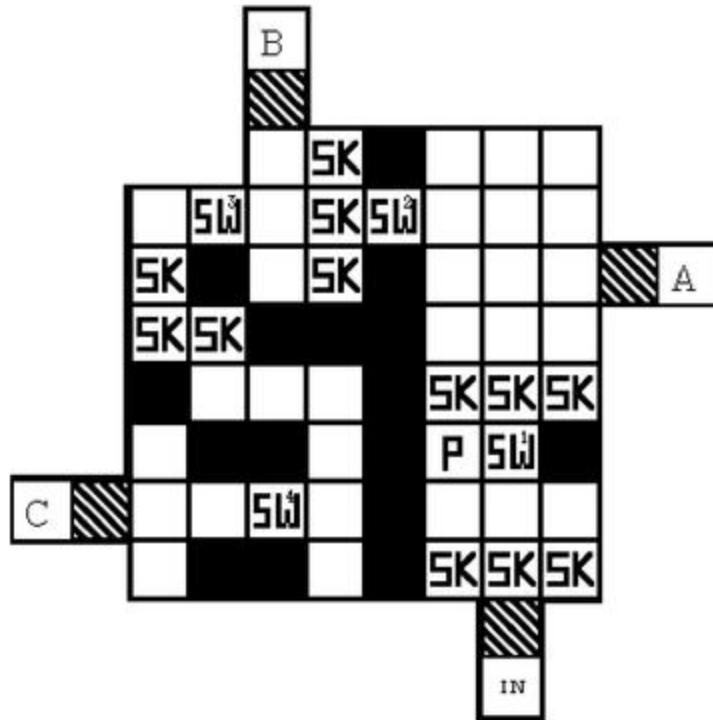

(1) The first floor switch will teleport a character back to the three skull tiles by the S entrance. Only when all three skull tiles are occupied will a character be able to walk over the switch into the next area. (This principle is the same for all of the switches in this room).

(2) Go through exit A and return later with a CRYSTAL key. Reach exit B with the same principle explained in (1) above.

(3) The problem appears when you have returned with the EMERALD key. Stand a character on SW3 once all three other characters are on the skull tiles. Now you must get them to 'leap frog' over the switch. Use Missile Teleport to teleport each one over the switch to the skull tiles beyond it.

(4) All four characters should be beyond SW3 now. Line three up on the skull tiles and get the last one to walk over SW4 and unlock the W door (exit C) with the EMERALD key.

(M) *Iyoto - Level 2, room 7*

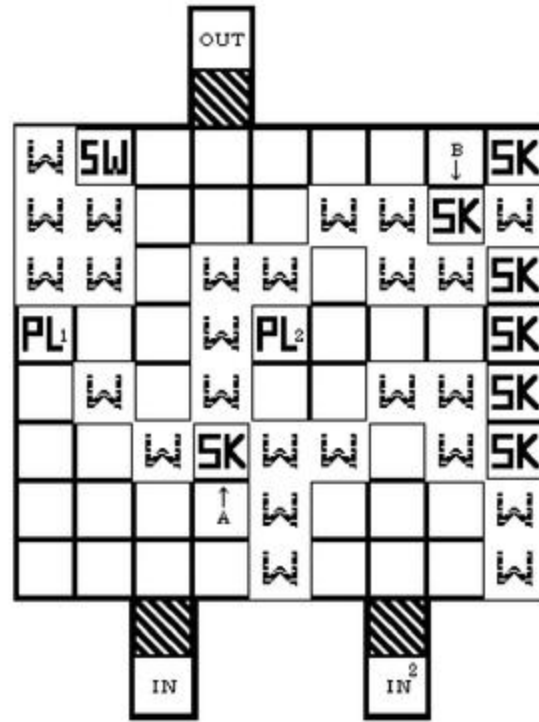

(1) *PL1* moves Skull tile *SKa* eastwards each time it is pushed. Therefore, push *PL1* twice to give access to *PL2* from the *E* side. (You can't actually get to *PL2* until you have the *SILVER* key and have returned to this room).

(2) Once into the *E* side, push *PL2*. The door opened with the *SILVER* key will close and lock as you approach *PL2*. Pushing *PL2* will move *SKb* to the east.

(3) You can now walk over to the *N* exit. As you step off the *NE* skull tile it will turn to water.

(4) The *NW* floor switch is for use on the return journey back through this room when you try leaving *Iyoto*. Standing on the switch will turn *PL1* so that it can be pushed. This will move *SKa* back in a west direction each time. Keeping pushing until the party can walk across and go back through the *S* door in the *W* side and leave.

(N) Iyoto - Level 2, room 17

This room contains the second of the amulet shards!

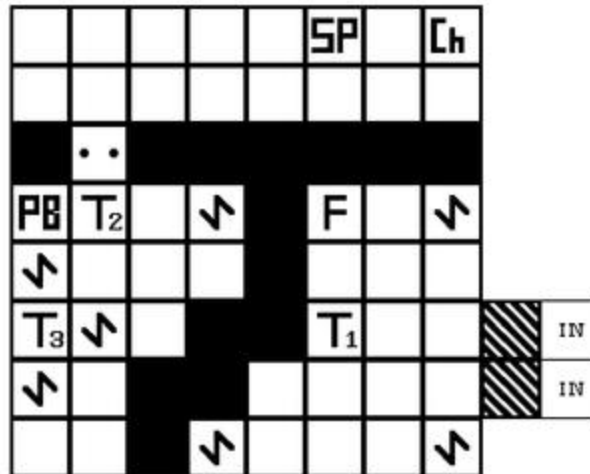

- (1) Step 3 characters on the 3 floor runes in the area near the entrance. Step last member on T1 to be teleported to T2.*
- (2) Push PB. This makes the shooting pillar fire at the furniture, which sends bolts in four directions.*
- (3) Stand character on T3. The shooting pillar will fire at you and the column will disappear!*
- (4) Push the PB again. Immediately step onto the floor rune east of T2. You should be hit by the shooting pillar. The nearby spikes will lower!*
- (5) Walk the character to the chest. Open the chest and take the Amulet Shard from inside.*

(O) Tokjama - Level 1, room 15.

The objective in here is to reach the W exit.

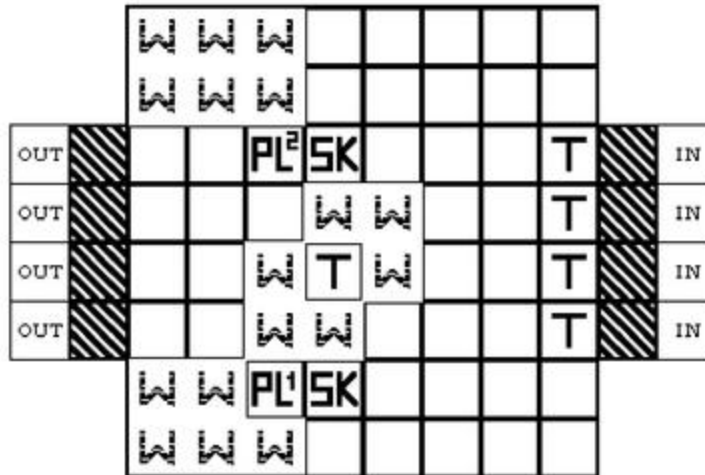

(1) You must first fight paralyze a monster on one of the Teleport pads by the E exit and keep him there for as long as possible.

(2) Get 'A' to push PL2 once. The Skull tile by PL1 will move N once, creating access to the middle Teleport pad.

(3) Ensure that all four Teleport pads are occupied, then step 'A' onto the middle Teleport pad. Now get another character (who must step off one of the E teleport pads) to quickly push PL1 once, which moves the Skull tile by PL2 once S.

(4) The character in the middle can now enter the W side of the room (as long as it isn't over crowded with monsters).

If you step onto the middle Teleport pad and the four pads to the E aren't all occupied, then you will be teleported over to the E side.

(P) Tokijama - Level 1, room 32.

You must get the Amulet Shard out of the SW chest.

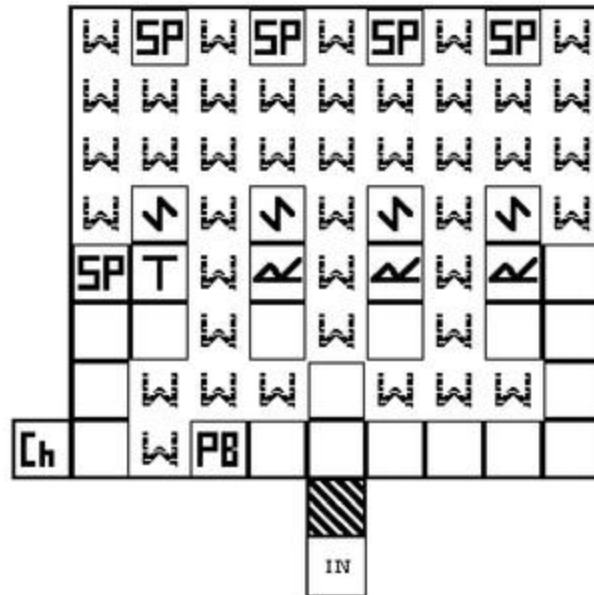

- (1) The four shooting pillars are firing damaging bolts southwards at the floor runes in turn.*
- (2) Whoever you use to get to the chest, they must be able to antimage and regenerate themselves a couple of times during this room, (e.g if your Runemaster has an Amber Staff then use him).*
- (3) Stand the nominated character ('A') near to the far E Teleport floor rune. Ensure that he is on the edge of any damaging explosions that emit from the shooting pillar nearby.*
- (4) Get another character to press the pillar button. A teleport spell is fired across the room. Quickly stand 'A' on the far east Teleport rune and he will be hit by the teleport spell and sent across to the next Teleport rune.*
- (5) Quickly press the pillar button twice more to teleport 'A' onto the Teleport pad. 'A' will have to protect himself a couple of times as the damaging bolts will dispel any magical protection each time they strike.*
- (6) With 'A' on the teleport pad, quickly go to the chest and open it. Take the Amulet Shard.*

(Q) Tokjama - Level 2, room 9.

This is another dangerous room which contains damaging spells. The NE door is locked with TOPAZ and the key is in the NW chest.



- (1) Both shooting pillars fire damaging spells at the floor runes in here. Quickly walk three characters onto the middle teleport pad to be teleported to the 3 skull tiles in the SW corner.*
- (2) The last character should be very strong or have the ability to magically protect himself a couple of times. Stand him on the teleport pad and he can press the pillar button.*
- (3) The last character can now walk to the 3 skull tiles. A tile has also created a path to the NW chest. Take the TOPAZ key from the chest. Get the NE door unlocked.*

(R) Tokjama - Level 2, room 20.

You must work out a way to reach the N furniture and take the GOLD key from inside it (this key is needed on level 1).

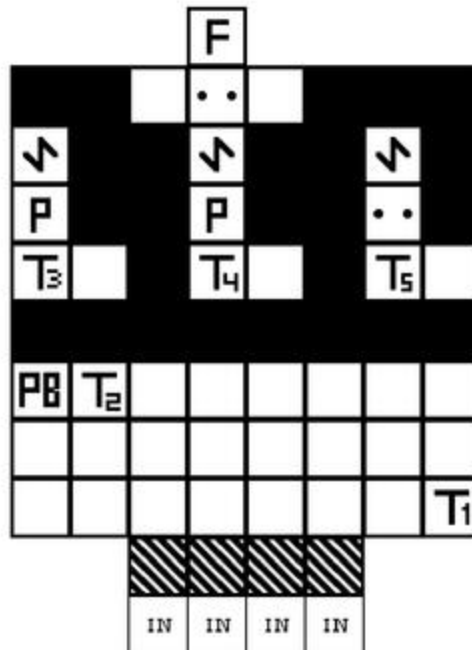

- (1) Stand the Runemaster ('R') by the pillar button PB on Teleport pad T2. Push PB. 'R' is teleported across all of the Teleport pads in this room and will end up back on T2.*
- (2) Stand another character ('B') on T1. Get 'T' to walk onto T2 just after 'R' has pushed PB. 'R' will be teleported once again but because T1 and T2 are occupied, he will end up stopping on T5.*
- (3) From T5, 'R' must cast MISSILE DAMAGE at the floor rune N of T5, beyond the spikes. This will turn the NW pillar into spikes. Now 'T' must push PB. He will end up on T4.*
- (4) 'R' must step off T5 and step back onto it again. He will be teleported to T2. 'R' must now push PB again and he will end up on T3. 'R' should now cast MISSILE DAMAGE at the rune in the NW corner. The middle pillar in the room will disappear.*
- (5) Stand 'A' on T2. Move 'T' off and back onto T4. He will now be teleported to T5. 'R' should stand off and on T3. He will be teleported to T4. Now cast MISSILE DAMAGE at the floor rune N of the spikes. The spikes will drop. Step forward, open the furniture and take the key.*

(S) Guidata - Level 1, room 18

You must reach the chest in the middle of the room, to get a BRONZE key.

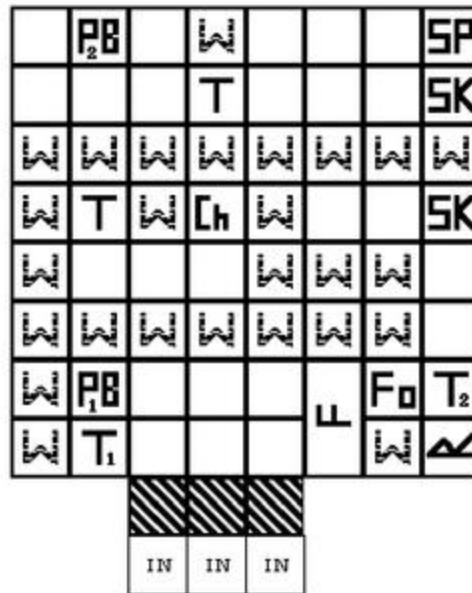

- (1) Stepping onto Teleport T1 will move 'A' to furthest west position from E skull tile. Stepping on Teleport pad T2 will send you back to the S area where you started, so don't!
- (2) So, get 'A' to step on T1 to arrive near east Skull tile. Get 'B' to press Pillar button PB1 once. 'A' is hit by a teleport spell from the NE shooting pillar.
- (3) Teleport 'A' to the rune in the very SE corner, beyond T2.
- (4) Send another character 'C' over by standing on T1. Now, get 'B' to press PB1 once again. As soon as the spell has shot past, get 'C' to stand on the E skull tile before the spell hits 'A' who is on the SE rune.
- (5) When the spell hits 'A', 'C' will be teleported to the Skull tile by the shooting pillar in the N region. Teleport him to in front of Pillar button 2. Push PB2 to create a path to the chest. Teleport over the Teleport pads to reach the chest and open it. Get the BRONZE key and leave.

(T) Guidato - Level 1, room 26

This is a potentially lethal room. It is very dangerous thanks to the potent spells that are fired in here. You must act quickly without hesitation if you are to survive. To solve the room ALL characters must survive.

The objective here is to reach the N exit. The monsters in here must be destroyed first and receiving damage is unavoidable!

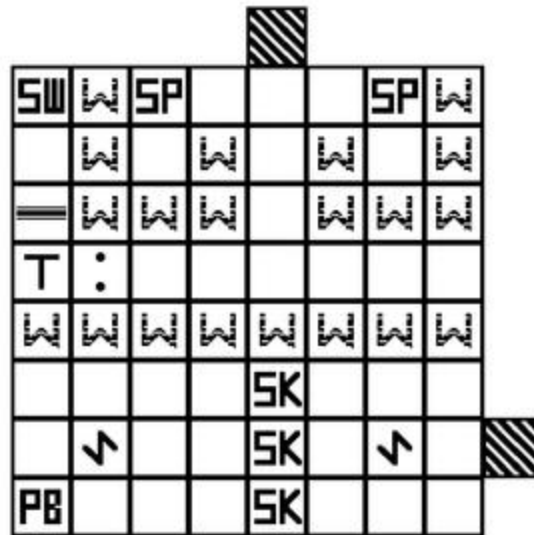

(1) The shooting pillars fire lethal spells at the floor runes. The only safe area is on the 3 skull tiles where the spells do not reach. Quickly send three characters to the skull tiles and line them up. The fourth must brave the spells and press the SW corner pillar button.

(2) This will create a floor tile allowing access to the door on the W. The Teleport pad in front of the door will send you back if the 3 skull tiles are not occupied. There are spikes to the E of the Teleport pad.

(3) The door needs a RUBY key which you should already have had for some time on this level. Open it and walk through.

(4) Stand on the floor switch in the NW corner and the spikes will lower. Dash to the N exit!

(U) Guidato - Level 2, room 8.

You must eventually reach the W exit. This will involve leaving via the other N exits and returning.

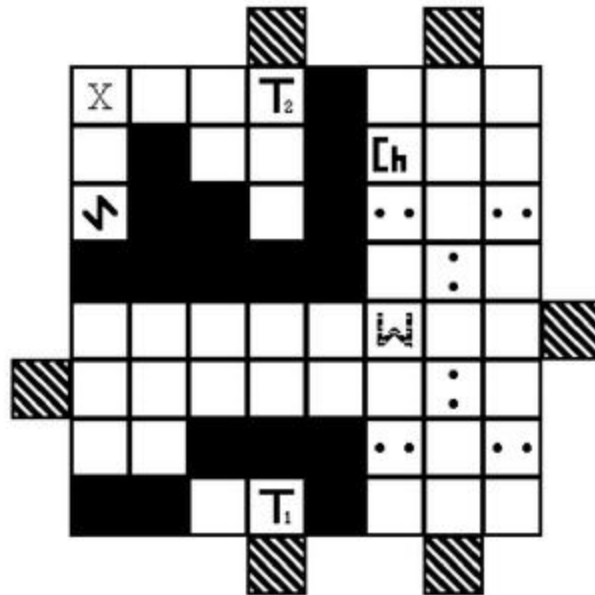

(1) This room is split into 4 separate areas. Enter from the left hand S door. You will step on T1 and end up at T2. Simply go through the N door.

(2) Come back with the RUBY key and unlock the right hand N door which leads back into room 8. Once in this NE area, open the chest and take the IRON key.

(3) Walk back to the other N door and step on T2 again to be taken back to T1. Leave this room and go into the corridor then re-enter with the Runemaster as leader. He should have the ability to teleport. Get him into the correct position to be able to fire a Missile Damage Surround Missile Damage at point X. The spell will hit the floor rune to the W.

(4) The water tile is now a skull tile, giving access to the W door. This is unlocked with the IRON key.

(V) Guidato - Level 2, room 20.

The ultimate objective is to leave via the E exit (which is not opened by normal means).

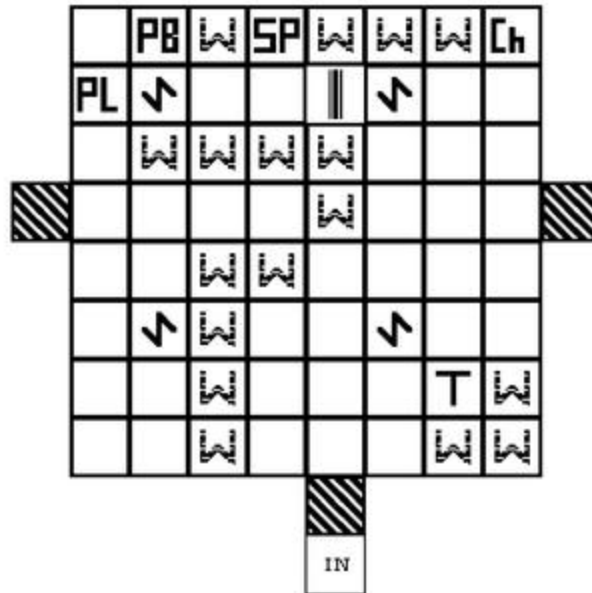

- (1) Stand 'B' on the Teleport pad. He is teleported to the rune in the middle of the room.
- (2) Leave via the W exit. Return later with the AZURE key. Stand on the middle rune and get someone else to pull the pillar lever. You will be teleported to the E side. Unlock the NE door. Walk to the pillar button. Press the button. The pillar lever will turn and face E. It is now accessible to the same character who pressed the button.
- (3) Now stand the remaining three characters on the three floor runes. (You will have to stand two of them on the middle rune in turn and pull the lever to fire the shooting pillar and teleport them over to the E side).
- (4) With three characters standing on the floor rune and the fourth standing by the pillar button and lever, pull the lever. The shooting pillar will fire again. The spell will now hit all 4 characters and the E door will open.

(X) Odd Shrine - Level 1, room 10.

This room is divided into four separate areas. You must reach the middle teleport pad which has a key on it.

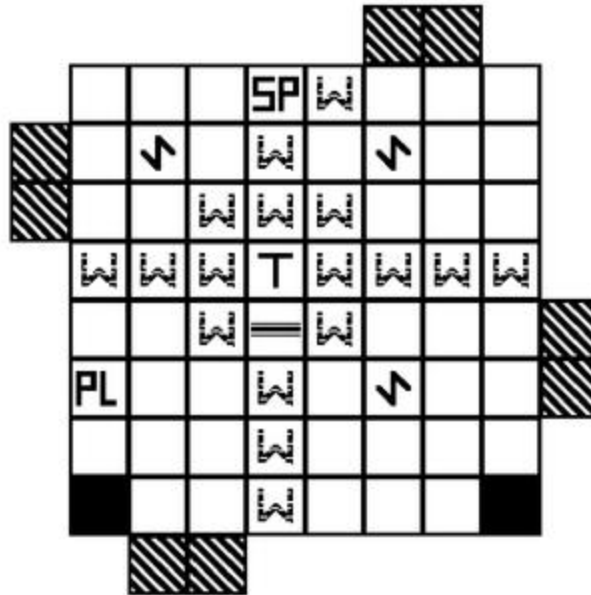

- (1) To solve this room, you must have one character standing on each floor rune in each of the four regions.*
- (2) The only way to achieve this is to move to each area in turn and kill one of your own party! Get your Runemaster to do the deed. Leave their bones on the relevant floor rune then leave.*
- (3) Once you've done this with 3 of the characters, get the Runemaster into the last region and have him fire a MISSILE VIVIFY spell at each pile of bones until you have your party alive again.*
- (4) Now pull the pillar lever. Four new skull tiles will appear that connect the four regions together. The door is also now accessible. Unlock it with a DIAMOND key and take the key in the middle.*

It's best to not only VIVIFY, but use REGENERATION and ANTIMAGE too when bringing the characters back to life. Also have some Holy Relics or Craven Images to restore the Luck points back to decent levels afterwards.

(Y) Odd Shrine - Level 1, room 35.

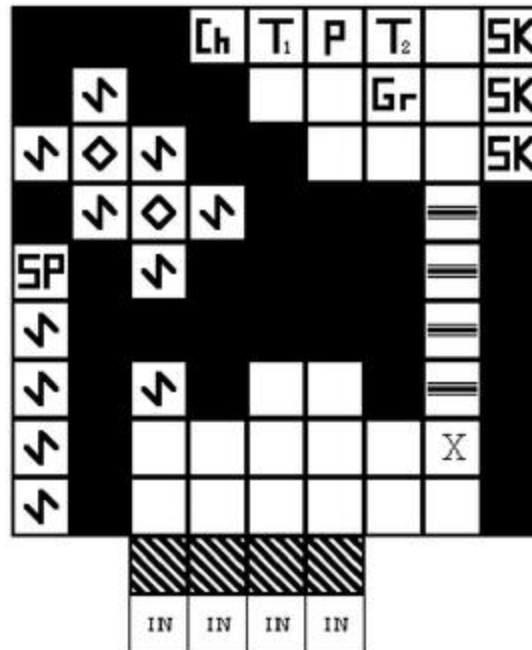

The objective here is to reach the N chest and take the Eternal Blade.

(1) To solve this room you must get through the four doors that won't "budge". To achieve this, the Runemaster must cast a number of spells.

(2) With all four doors closed, the Runemaster should cast MISSILE DAMAGE at the floor rune nearby. The shooting pillar will fire and the first door will open.

(3) Now get another character ('B') to step through the first door. The Runemaster should now cast MISSILE DAMAGE DAMAGE at the rune. The second door will open. Get 'B' to step through the second door.

(4) The Runemaster should now cast MISSILE DAMAGE DAMAGE DAMAGE at the floor rune. The third door will open but the first two will now close!

(5) To open the final (fourth) door the Runemaster must cast MISSILE DAMAGE DAMAGE DAMAGE at the rune. Get 'B' to step through the last door and into the NE area. Position him onto one of the three skull tiles there.

(6) Now you must do the same thing all over again for the other two characters until all three skull tiles are occupied.

(7) Finally you must get the Runemaster to cast *MISSILE DAMAGE* then *MISSILE DAMAGE DAMAGE* to open the first two doors yet again. However, now there is a dilemma. How to cast the last two spells and get through the last two doors!

(8) Stand the Runemaster at position 'X', then cast *TELEPORT* on the him (by spells, rings, potions etc). Now get him to cast *MISSILE SURROUND DAMAGE DAMAGE DAMAGE CONTINUOUS DAMAGE DAMAGE DAMAGE DAMAGE* at the floor tile before the rune.

(9) The instant you cast the spell, teleport the Runemaster to the position between door 2 and 3 before the first two doors close. Door 3 will open. A moment later and door 4 will then open

(10) Get the Runemaster to approach the chest. He can step on Teleport pad T1 safely (because the skull tiles are occupied) and he can open the chest and take the *Eternal Blade* (Figure 3).

Teleport pad T2 will take you back to the S area so avoid it until you wish to come back,



Figure 3 - Taking the Eternal Blade



Armed with the *Eternal blade*, you can now take on the evil army banner (left) and try to destroy *Tetrahaael*!

(Z) The Mad Monks - Level 1 (first and second visit)

On your first visit, you must simply cast a paralyze spell at the rune in the centre of the room. You might have to stand the four character around on the rune as indicated by the arrows on the floor before you cast. The S door will then open and you can go down to the solitary room on level 2.

However, we are concerned here with your second visit to the Monks. This is a genuine puzzle room which needs a Thrall spell and some exact timing.

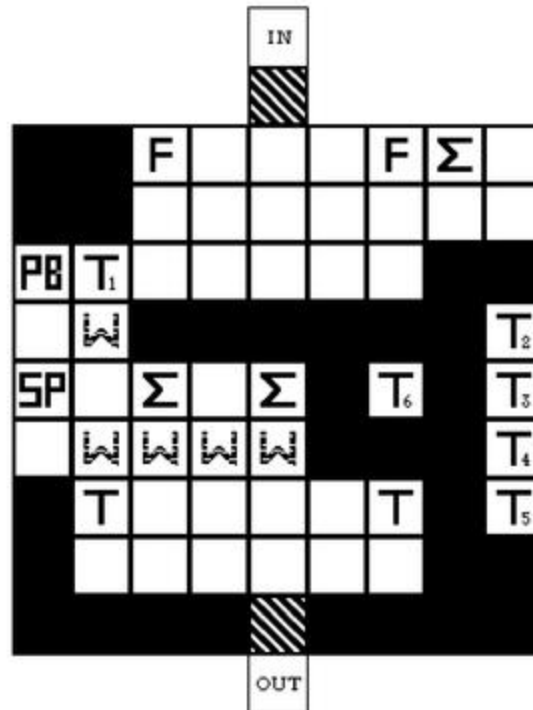

(1) Step 'A' onto Teleport pad T1. Position the Runemaster near to the Thrall floor rune in the NE corner. Ready a Thrall spell which will hit the rune (Missile Thrall or Surround Thrall or a relevant scroll). Get 'A' to press the pillar button PB. 'A' will be teleported between the Teleport pads T2 - T5 and end up in the middle on T6.

(3) Quickly get the Runemaster to cast the Thrall spell at the NE floor rune before the shooting pillar has had a chance to fire. The pillar will then fire and hit the rune nearest to it. This will teleport 'A' from T6 to the S side. (The shooting pillar will otherwise fire and hit the next rune along and teleport 'A' from T6 back to the N area).

(4) The other nearby Teleport pad on this side will take you back to the N side when you return from level 2.

(Z) Mad Monks - Level 1 (third and fourth visit)

Your third visit to the monks is dangerous because the room will be full of dangerous spells. Simply get through and out of here a.s.a.p. Don't try and fight anyone in here as you will surely die!

We are concerned with your fourth visit.

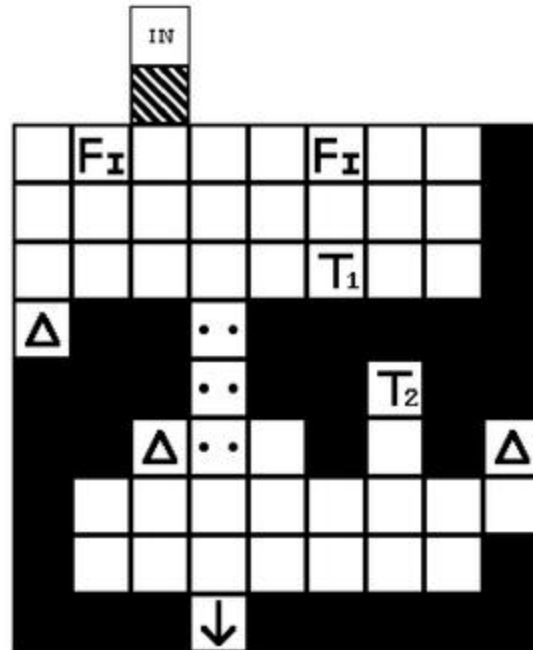

(1) This room has three sets of spikes that must be lowered by the Runemaster casting spells at the three floor runes.

(2) Cast *MISSILE DISRUPT* at the *W* floor rune to lower the first set of spikes. Cast *MISSILE SURROUND DISRUPT* at the second set of spikes to hit the rune next to them. The second set of spikes will lower.

(3) Stand where the second spikes used to be. Aim diagonally *SE* from that position and cast the spell *MISSILE DISRUPT SURROUND DISRUPT MISSILE DISRUPT*. This spell should eventually hit the third and final floor rune in the *E* and lower the last group of spikes!

(4) On the way back, use teleport pad *T2* to move you quickly to *T1* in the *N* half.

Attacking Tetrahagael

Once you have the Eternal Blade from the Odd Shrine, give it to the Assassin. It's now time to take a quick trip to the Mad Monks to ensure all of your party are trained up to their maximum allowed levels. Remember that each training session costs 8000 gold.

Once you have finished training, it's time to intercept the evil army banner on the map and take on Tetrahagael!

Ensure that your Assassin has equipped the Eternal Blade before you attack. Also be aware that the save game function is disabled when you encounter Tetrahagael's army, so save before you leave the Mad Monks.



Figure 4 - Attacking Tetrahagael

When you intercept the evil army, you will come face-to-face with Tetrahagael himself (Figure 4), who lists misquoting Macbeth as one of his hobbies! The only option you have is to 'Attack', so I hope you're ready!

If you've got this far, then you should be able to formulate a strategy for defeating Tetrahagael and his foul army. Just remember to get the Assassin to hide in the shadows and to attack Tetrahagael from behind with the Eternal Blade. The rest is up to you!



Figure 5 - Beaten at the last hurdle!

If you are successful, the defeated Tetrahageal will cry "Again! Again I am banished by mortals. Very well, but do not think you have seen the last of my kind."

The game will then have the final say:

"Again was the Lord of Chaos, Tetrahageal, denied access to the land of the living. With the destruction of the minions of chaos, the men of the Empire were again united beneath the flag of Imperia".

Mini-facts

During the game's development, the names of some of the locations changed. Kishyai was originally called Delmortis and Iyoto was called Zorendorf.

A 256-colour PC only demo called "Runemaster's Revenge" was created to demonstrate the proposed next installment in the series, but for various reasons it was never commissioned.

Although 'Legend' and 'Son of the Empire' look very similar, it's easy to tell them apart. In 'Legend' the Runemaster's screen is predominantly red, whilst in the follow-up it is mainly green. The border around the isometric view is similarly green in 'Son of the Empire' compared to a dark turquoise/blue in 'Legend'.

Reviews

"Legend was a hit and Worlds of Legend will undoubtedly follow in its footsteps." Amiga Action – 79%

"Worlds of Legend is top stuff and no mistaking." The One – 89%

"Once you start Empire you'll soon be dragged in so far that it's hard to stop." CV Amiga – 90%

... and that really is it! Well, as long as you don't count the unpublished and unfinished Gameboy Advance version of 'Legend'...