

TECHNICAL
ORDER NO.

64-H-029A

1 NOV 1986
CHANGE 1

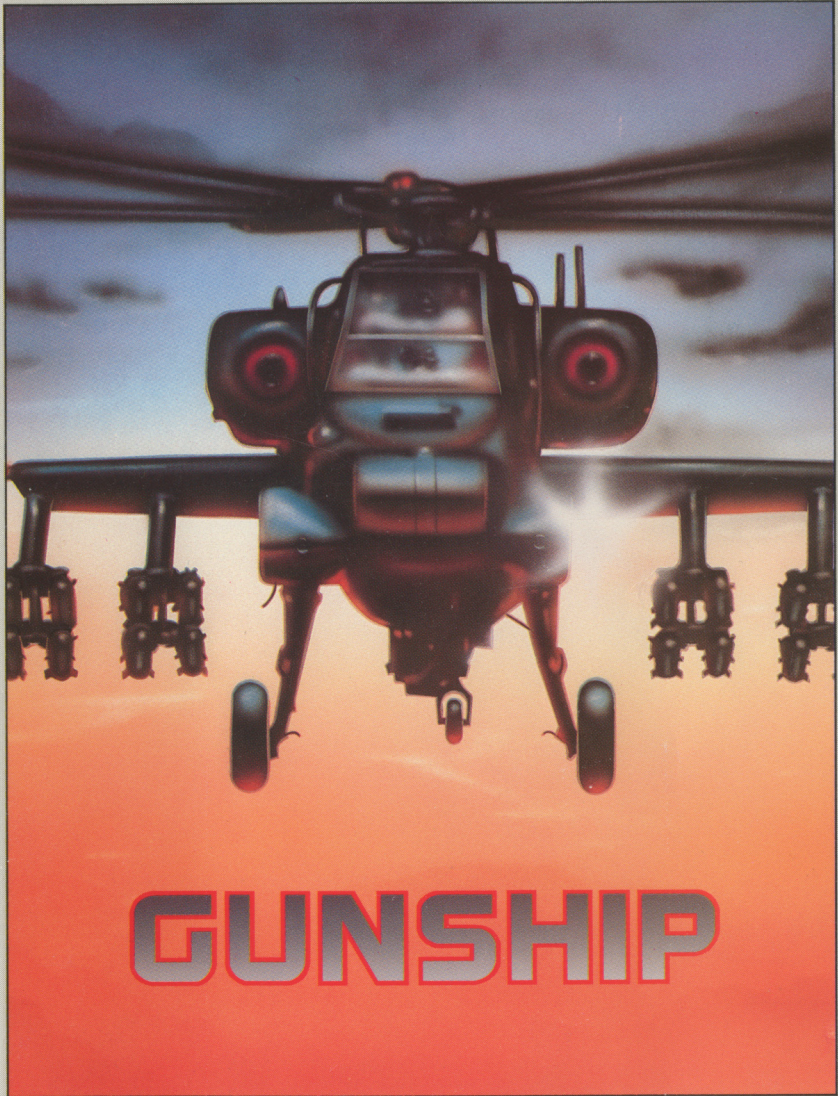

OPERATIONS MANUAL

GUNSHIP

The Helicopter Simulation

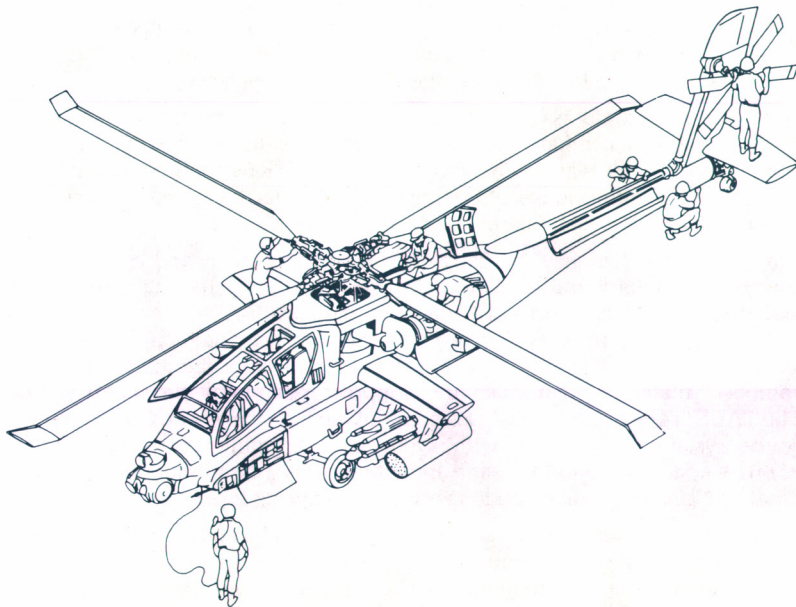

OPERATIONS MANUAL

64-H-029A

Change 1, November 1986

Copyright ©1986 by MicroProse Software
120 Lakefront Drive, Hunt Valley, MD 21030
(301) 771-1151

GUNSHIP is a trademark of MicroProse Software, Inc.

Tandy, Commodore 64, Atari, Apple, IBM and Amiga are registered trademarks of Tandy Corporation, Commodore Business Machines Inc., Atari Inc., Apple Computers Inc., International Business Machines Inc. and Commodore Business Machines Inc.



INTRODUCTION

In the early days of flying “barnstormer” pilots flew by the seat of their pants — following roads and rivers, even dipping down to read road signs! That grand tradition of individual flying is found today among helicopter pilots. They love getting down among the hills and trees to do some “interesting” flying.

Just flying a helicopter is loads of fun, but here at MicroProse we wanted more. We wanted to fly a **combat** helicopter in simulated battle conditions. All kinds of battles: from guerilla wars to a hypothetical USA-USSR war in Europe. Pop over a hill, launch a Hellfire, dodge a SAM, jam a ZSU's radar, then duck behind cover again. GUNSHIP™ is a simulation of everything we wanted.

Now you can experience the danger, excitement, courage, and agony of real combat helicopter flying — without the bloodshed and suffering that occur in real warfare. GUNSHIP portrays actual ground scales, flight speeds and weapons systems. The AH-64A is the “highest tech” helicopter flying today, replete with lasers, cameras, night viewers, infra red and radar warnings, jammers, computers, composite materials, engine signature suppressors, and a plethora of weapons. The TADS (Target Acquisition & Designation Sight) system is a computerized fire control system, also simulated within your computer! Faithfully reproducing the AH-64A systems, capabilities, and limitations was an enormous undertaking. Creating GUNSHIP took much longer than we expected.

We're sure you'll agree our time was well spent. GUNSHIP is the most detailed and realistic simulation of combat helicopter flying ever for home computer. For us, it's the next best thing to joining the US Army and flying the real aircraft. So grab your IHADSS helmet, jump into the cockpit, and swing into action with our AH-64A Apache gunship!

CONTENTS

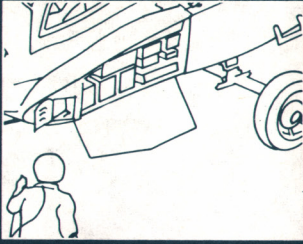

Introduction	2
Quickstart	4
Part I — Operating Instructions	5
Loading	6
Preparing to Fly	9
Cockpit & Status Panels	13
A Practical Guide	20
Controls	25
Controls Summary	29
Beginner's Tutorial I	30
Beginner's Tutorial II	34
After the Mission	38
Part II — Apache Pilot's Manual	40
Aerodynamics	41
Weapons & Tactics	48
Military Equipment	58
Regional Deployments	73
Glossary	80
Notes	82

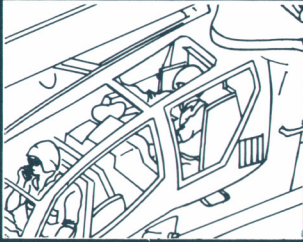

QUICKSTART

BEWARE: GUNSHIP is an accurate simulation of a combat helicopter. Do not attempt to jump in and fly by instinct. Helicopters are similar to other aircraft, but have important differences. Unless you've flown real helicopters, read Part I ("Operating Instructions") carefully and learn to fly using the tutorials.

1. To load GUNSHIP in your computer, read the appropriate section of "Loading" in Part I. Get out the overlay and place it on the keyboard.

2. Skim the "Cockpit & Status Panels" and "Controls" sections to familiarize yourself with the helicopter. Also glance through "A Practical Guide to Helicopter Flying".

3. Follow the tutorials: First turn to "Beginner's Tutorial I — Learning to Fly a Helicopter." Follow this step by step. You'll refer frequently to both "Cockpit" and "Controls" sections. Then follow "Beginner's Tutorial II — Gunnery & Defenses."

If you are still uncertain about flying after both tutorials, continue flying the USA training area. Refer to "A Practical Guide to Helicopter Flying" and "Aerodynamics" for a better understanding of flight. Then fly the tutorials again.

4. Begin combat flying in Southeast Asia, just like thousands of other American helicopter pilots. Turn to "Regional Deployments" in the back of this manual for tips and suggestions about that region.

5. Don't Volunteer for Western Europe: Watch the risk level as you adjust your starting options. Keep your risk low at first. Above all, avoid the 1st Line in Western Europe. The Warsaw Pact is the most formidable enemy on this planet.

PART I
OPERATING INSTRUCTIONS

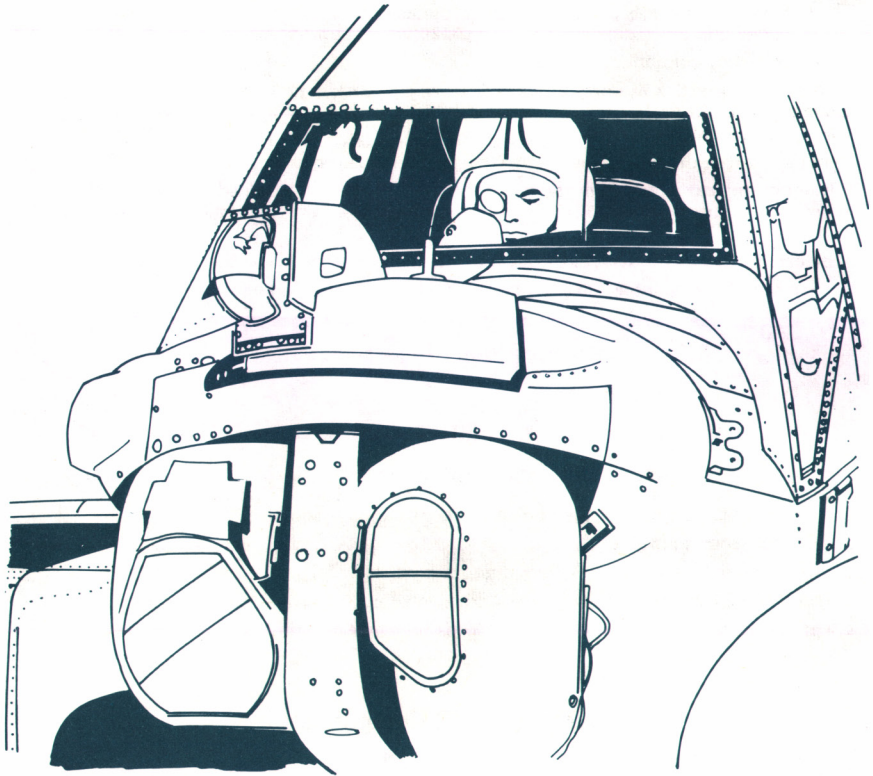



LOADING the AH-64A Apache Simulation

Commodore C-64/C-128 Computers

This version requires a C-64, C-64C or C-128 with a 1541 or 1571 disk drive and a joystick. The C-128 GUNSHIP uses the C-64 emulation mode. However, it does take advantage of the greater speed and processing power of the C-128 where appropriate.

1. **Turn off your computer** and disk drive.
2. **Attach one joystick at port #2.** Do NOT leave a joystick in port #1 (a joystick there can scramble your controls).
3. **Turn on your disk drive.** WARNING: do not leave a disk in the drive when you turn your computer or disk drive on or off – your disk could be damaged.
4. **Remove any cartridges** from your computer. GUNSHIP has a “fast load” routine built into its software for use with the 1541 drive. Remove all fast load cartridges before attempting to load the game.
5. **Insert the GUNSHIP disk**, label upward, into the disk drive. Close the drive door latch.
6. **Turn on your computer.** On a C-128 the simulation begins loading automatically. If you have a C-64, you must type the following:
LOAD “”, 8, 1**
and then press RETURN. After loading leave the disk in the drive.

Apple II family Computers

This version requires an Apple II+ with 64K RAM, and Apple IIe (with either 64K or 128K RAM), or an Apple IIc. The computer must have APPLESOFT BASIC in ROM, a disk drive, the disk drive controller in slot 6 (its normal position), and a joystick.

1. **Turn off your computer.**
2. **Plug in your joystick.** GUNSHIP requires a joystick.
3. **Insert the GUNSHIP disk** in the disk drive, label upwards, and close the latch.
4. **Turn on your computer.** The simulation loads automatically. After loading leave the disk in the drive.

Atari 800XL/XE Computers

This version requires an Atari 800XL, 1200XL, 130XE or 65XE with a disk drive and a joystick.

1. **Turn off your computer** and disk drive.
2. **Remove all cartridges.**
3. **Plug in your joystick** into port #1.
4. **Turn on your disk drive.**
5. **Insert the GUNSHIP disk**, label upwards, into the disk drive and close the latch on the disk drive door.
6. **Turn on your computer.** The simulation loads automatically from disk. After loading leave the disk in the drive.

IBM PC, PCjr, XT, and AT; Tandy 1000, 1200 and 3000; 100% PC Compatibles

This version requires an IBM compatible computer, a disk drive, and a color monitor using either CGA (Color Graphics Adapter) or EGA (Enhanced Graphic Adapter) graphics. A joystick is optional, but strongly recommended.

This simulation is NOT compatible with a Hercules monochrome graphics card or other monochrome graphics devices. The simulation does NOT use PC DOS or MS DOS, and therefore cannot use hardware or software that requires a DOS environment.

- 1. Turn off your computer.**
- 2. Plug in your joystick** if you are using one.
- 3. Insert the GUNSHIP disk**, label up, into the "A" disk drive. Then close the drive door latch.
- 4. Turn on your computer.** The simulation loads automatically. After loading leave the disk in the drive.

Atari 520 ST or 1040 ST

This version requires an Atari 520 or 1040 ST with a disk drive, a color monitor, and either a mouse or a joystick. TOS can be in ROM or loaded from disk.

- 1. Turn off your computer.**
- 2. Plug in your mouse or joystick.** The mouse must be plugged into port #1 (the normal port). The joystick must be plugged into port #2.
- 3. Turn on the computer.**
- 4. TOS in ROM.** All 1040's and all recently built 520's have TOS in ROM. If you have such a machine, simply **insert the GUNSHIP disk** into the disk drive. The simulation loads automatically.
- 4. NO TOS in ROM.** If your computer is an early-version 520 ST without TOS ROM chips, insert your Atari TOS disk into the drive. When the desktop appears, eject the TOS disk and insert the Gunship disk. Press the ESC key to display the contents of the Gunship disk. When these appear, use the mouse to point to the AUTO folder and double-click with the **left** mouse button.

This folder will open and show a file called GUNSHIP.PRG. Point to this with the mouse and double-click again to load the game. After loading leave the disk in the drive.

Commodore Amiga

This version requires an Amiga with at least 512K RAM. A mouse or joystick can be used.

- 1. Turn off your computer.**
- 2. Plug in your mouse or joystick.** The mouse must be plugged into port #1 (the normal port). The joystick must be plugged into port #2.
- 3. Turn on the computer.**
- 4. Insert the Amiga KICKSTART disk** into the disk drive.
- 5. When the "Workbench" icon appears** on the screen, press the eject button and remove the KICKSTART disk.
- 6. Insert the GUNSHIP disk** into the disk drive. It loads automatically. After loading leave the disk in the drive.

GUNSHIP: Special Instructions for the C64 Tape Cassette Version

GUNSHIP is a very large C64 program, designed for computers with disk drives (the standard American practice). It has about 300K of code and data. In creating the tape cassette version, MicroProse has adjusted a few minor details to minimize tape loading times. No essential feature of the game has been removed. For reference the differences are described below.

LOADING

(page 6)

To load the tape cassette version requires either a C-64 or C-128 computer with a cassette tape drive.

- 1. Turn off your computer**, then remove all cartridges from the computer.
- 2. Attach one joystick at port #2.** Do not leave a joystick in port #1 (a joystick there can scramble your controls).
- 3. Insert the GUNSHIP cassette** into the cassette tape drive, label upward. This is SIDE 1 of the tape. Close the tape drive.
- 4. Turn on your computer.** If you have a C-128, hold down the Commodore key while turning on the computer.
- 5. Load Tape:** hold down the Commodore key and tap the RUN STOP key. Your C64/C128 will ask you to press PLAY on the tape drive. Do it. The tape will search for GUNSHIP, report finding it, and begin loading.

Note: As in most tape cassette programs, once you press PLAY, leave it down until some other instruction (such as REWIND) is given. The program cannot access the tape unless PLAY is down.

PREPARING TO FLY

(page 9)

AH-64A PILOT ROSTER ("SERVICE RECORD"): The tape cassette version only holds information on ONE pilot. If you point to "SAVE" and press the fire button the pilot is saved to a separate tape cassette (you cannot save it to the game tape cassette). If you point to "RELOAD" and press fire you can recall a pilot saved on a separate cassette. Remember, you cannot save a pilot unless you have a blank tape to store his service record data. NEVER attempt to save pilot data on the GUNSHIP game tape cassette.

COCKPIT & STATUS PANELS

(page 13)

STORES STATUS DISPLAY (pg 18): This display is not available in the tape version. Use information on the main cockpit display instead, as described in the middle of page 15.

SYSTEMS DAMAGE DISPLAY (pg 18): This display is not available in the tape version. Use the "idiot lights" across the top of the cockpit instead, as described on the bottom of page 15.

AFTER THE MISSION

(page 38)

RETRY OPTION: Whenever you land, shut down the engines and the rotor stops turning, you have the option of either "retrying" the same mission again, or continuing. If you retry, you are able to fly the very same mission again, from the start. If you do not retry, your mission is summarized and then your after-landing options are presented. Note that this is different from the disk version, where only pilots who crash while at low rank can retry.

TOP SCORES: The comparison of your score to the two all-time top scoring missions (described in fourth paragraph) is not available in the tape version.

SAVE PILOT: One of your replay options is to "Go on extended R&R (Save Pilot)". This returns you to the pilot roster, where you can save your pilot's name and record on a separate tape (see Preparing to Fly, AH-64A Pilot Roster, above).

PREPARING TO FLY the AH-64A Apache

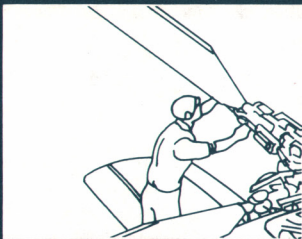

On most screens you'll see a small arrow pointer. Your joystick, mouse, and cursor control keys (depending on your computer) move the arrow. To make a selection, move the arrow onto the picture or box and then press the joystick fire button, mouse click button, or the return key on the keyboard.

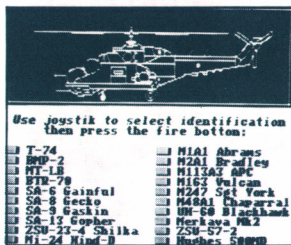

VEHICLE IDENTIFICATION: Telling the good guys from the bad guys takes practice. Examine the vehicle drawing and compare it to the drawings in the "Military Equipment" section of this manual. Move the pointer to the box beside the correct name and press fire/click/return.

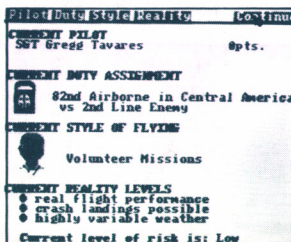

DEFAULTS: Here you see the last mission flown: the pilot, his duty assignment (region of the world), style of flying, and reality levels. To change any of the defaults point to the appropriate box in the upper left and press fire/click/return. If the defaults shown are fine, point to "Continue" and press fire/click/return.

The combination of duty assignment (region), style, and reality determines the overall level of risk for your next mission. The level of risk affects your scoring, promotion, and decorations.

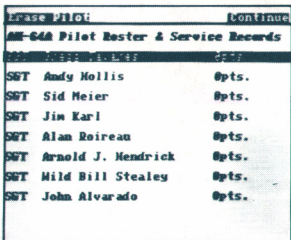





AH-64A PILOT ROSTER: This summarizes the "service records" of pilots on the disk. To select a name, point to the name itself and press fire/click/return. This highlights the name. Point to "Continue" and press fire/click/return to return to the defaults.



To enter a new name (such as your own!), select a name you wish to replace, then point to "Erase Pilot" and press fire/click/return. Type the new name and press RETURN. This new name appears in the roster. The old name is erased, permanently.

Each pilot's service record includes a list of awards, decorations, and reprimands, followed by a number indicating the quantity of each. The letter abbreviations are: **ACM**-Army Commendation Medal, **AM**-Air Medal, **BSV**-Bronze Star, **CAC**-Central America Campaign Ribbon, **CMOH**-Congressional Medal of Honor, **DSC**-Distinguished Service Cross, **KIA**-Killed in Action, **MEC**-Middle East

Campaign Ribbon, MIA-Missing in Action, NDS-National Defense Service Medal, PH-Purple Heart, SEAC-Southeast Asia Campaign Ribbon, SR-Service Reprimand, SS-Silver Star, WEC-Western Europe Campaign Ribbon.

Overall Risk: Low		Continue
CHOOSE YOUR DUTY ASSIGNMENT:		
	Flight Training in the USA: Learn to fly and fight against enemy aircraft.	
	1st Cavalry in Southeast Asia: A good fight. You, the enemy has poor weapons, but it's hard to find.	
	82nd Airborne in Central America: Tougher rumbles in the jungle. Guerrillas have better armaments.	
	101st Air Assault in Middle East: Desert duties. Beware the Russian-built SAMs and Flak guns.	
	3rd Armored in Western Europe: Desperate missions to stop the red steamroller from the east.	

difficult). Regions powerfully affect difficulty. Don't expect success in Western Europe until you do well in the other regions.

WHAT STYLE OF MISSIONS WILL YOU FLY?		Continue
	Regular Missions You best chance of surviving the war. No what you're told and the best home intact!	
	Volunteer Missions Step forward for tougher missions, extra risks, and a chance to be a hero.	
	Volunteer Hazardous Duty Just the ticket for gung-ho superheroes who don't worry about details like survival.	
Your overall level of risk is Very Low		

troops with lesser combat skills. This choice has a powerful effect on mission difficulty.

SELECT REALITY LEVELS:		Modify
FLYING YOUR HELICOPTER		
<input type="checkbox"/>	Realistic: real flight performance	
<input checked="" type="checkbox"/>	Easy: simplified	
LANDING YOUR HELICOPTER		
<input type="checkbox"/>	Realistic: all landing conditions possible	
<input checked="" type="checkbox"/>	Easy: all landings are perfect	
WEATHER EFFECTS		
<input type="checkbox"/>	Realistic: highly variable weather	
<input checked="" type="checkbox"/>	Easy: no wind, temperature 75°F	
SELECT ENEMY QUALITY:		
<input type="checkbox"/>	1st Line	
<input checked="" type="checkbox"/>	2nd Line	
<input type="checkbox"/>	3rd Line	
Overall Risk - Low		

pilots find the realistic level is actually easier to fly in combat.

Enemy quality determines the "newness" of enemy equipment. Soviet-equipped First Line troops have modern equipment (for that region). The Second Line rear area and allied forces use older equipment. The Third Line reservists have obsolete equipment.

OPS NUMBER 4289441	
OPS PASSWORD: PENTHOUSE	
OPS NUMBER 0288	
MISSION: Ground Support	
OBJECTIVE:	
You are to support friendly troops in the vicinity of grid (88-89). However, as a secondary objective, you may be ordered to destroy enemy infrastructure in the vicinity of grid (88-89).	
This is a night mission. The wind is blowing at 6 kts from East (099°) and the temperature is 68°.	

DUTY ASSIGNMENT: You can select five different areas of the world for combat flying. Point to the badge representing the area you desire and press fire/click/return. Point to "Continue" and press fire/click/return to return to the defaults.

Beginners should select Flight Training in the USA and follow the two tutorials. Combat regions are listed in order of difficulty, from Southeast Asia (the easiest) to Western Europe (the most difficult).

STYLE OF FLYING SELECTION: Within a region, some areas and missions are more dangerous than others. Here you select the level of danger you prefer. Point to the appropriate face and press fire/click/return.

Volunteer missions, especially hazardous duty, mean you're facing tougher, more accurate, and faster-reacting opponents. Regular missions pit you against "garden variety" Russian-trained troops with lesser combat skills. This choice has a powerful effect on mission difficulty.

REALITY SELECTION: Wherever you fly, you can select between a "realistic" simulation and an "easy," simplified version. Point to the box beside the option you prefer and press fire/click/return.

"Easy" reality levels may help you learn to fly. Beginners often prefer "easy" *landings* and *weather effects*. However, use "realistic" *flying* as soon as possible, since experienced GUNSHIP pilots find the realistic level is actually easier to fly in combat.

BRIEFING: Here are your flight orders. They include IMPORTANT information you should memorize or write down. Above all, note the **password**, look up the **countersign** in this manual and write it down. Passwords and countersigns appear at the bottom of each page in alphabetical order, starting on page 12.

Also make a note of your primary and secondary

objectives. You'll probably want to check the map to see where they are in relation to your bases. It's also wise to note the wind speed and direction (only present if you picked realistic weather conditions).

When you're through examining the orders and related information (map, intelligence reports, and/or sick call) point to "continue" and press fire/click/return.

NOTE: When flying "Training in the USA" duty the subsequent options are greatly abbreviated. No intelligence report or sick call option exists, and no reminders are necessary.

THE SECTOR MAP: This shows the entire battle area, friendly bases and forces in white, your objectives are in violet. It's purely for reference, and to help you plan your mission.

The map coordinates are read military fashion, "right and up." That means the first number is the horizontal scale, the second the vertical scale. For example, 01-12 is the upper left corner.

INTELLIGENCE REPORT: This report gives additional details about enemy forces and equipment. You may wish to read the "Military Equipment" section about these weapons, and/or the "Weapons & Tactics" section about how to deal with them.

SICK CALL: If you decide this mission is too difficult or dangerous, you can go on sick call to avoid it. Read the advice on the screen carefully.

As a rule, pilots decide to be "on sick call" if the objectives are distant from friendly base and the enemies are truly formidable. Objectives near a friendly base are always easier, since you spend less time in "hostile" airspace.

REMINDERS: It's important that you know the password, countersign, and both objectives (primary and secondary). Check your notes to make sure you have the correct information. Point to the appropriate box and press fire/click/return.

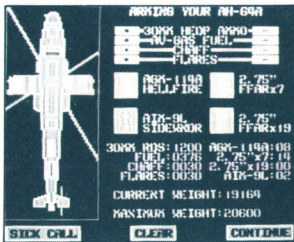

ARMING: A standard armament appears here for your region. However, you can adjust the stores on your helicopter to suit your preferences.

To add or subtract cannon ammunition (30mm HEDP), fuel, chaff, and/or flares, point to the "+" or "-" box and press fire/click/return. You'll see the appropriate quantity change, along with your current weight.

To remove armament from the weapons wings, point to the weapon on the wing itself and press fire/click/return. To add a new or different armament to a wing, point to the box representing the weapon and press fire/click/return to "pick up" the weapon. The weapon is now attached to your pointer. Move it to the wing and fire/click/return to release it. If there is already a weapon at that position, the new one replaces the previous one.

Weapons must be balanced. Whenever you add or subtract a weapon to one wing, the other automatically changes too. The wingtips carry AIM-9L Sidewinders only (anything else is too heavy). The interior wing stations can carry any weapon. The maximum weight figure near the bottom is the maximum

takeoff weight for the region and weather. You can **never** add weapons that exceed this limit.

Point to "Continue" and press fire/click/return to begin flying. Select "Clear" to eliminate all stores from your helicopter. Press "Sick Call" if you've got cold feet and want to back out of the mission. Sometimes even experienced pilots do this if unfavorable weather causes an impossibly low maximum weight on a dangerous mission.

IMPORTANT! KNOW YOUR PASSWORD & COUNTERSIGN!

The briefing and reminder screens (above) tell you the password for this mission. **YOU MUST KNOW THE COUNTERSIGN.** At the page bottoms in this manual you will see a password followed by a countersign. Find the page with the briefing's password, and then write down the countersign that follows.

When you approach any friendly heli-base, you will get a radio message giving the password and asking for the countersign. If you do not type in the proper countersign and press "RETURN", base defenses will presume you are an enemy and shoot you down!

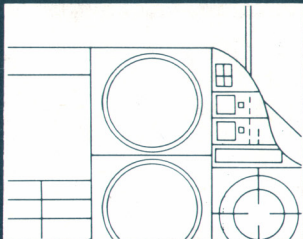

COCKPIT & STATUS PANELS

of the AH-64A Apache Simulator

COCKPIT INSTRUMENTATION

The cockpit is the main control panel used in flight. You "see" the landscape through the armored glass as you fly. A fixed crosshairs sight aids in pitch orientation and firing FFAR unguided rockets. A moving box (reticle) represents your IHADSS helmet gunsight (TADS). This box changes from dark to light color, depending on the current accuracy of your selected weapon (dark is low accuracy, light is higher accuracy). Below the cockpit glass are the dials, gauges, and displays of the helicopter cockpit.

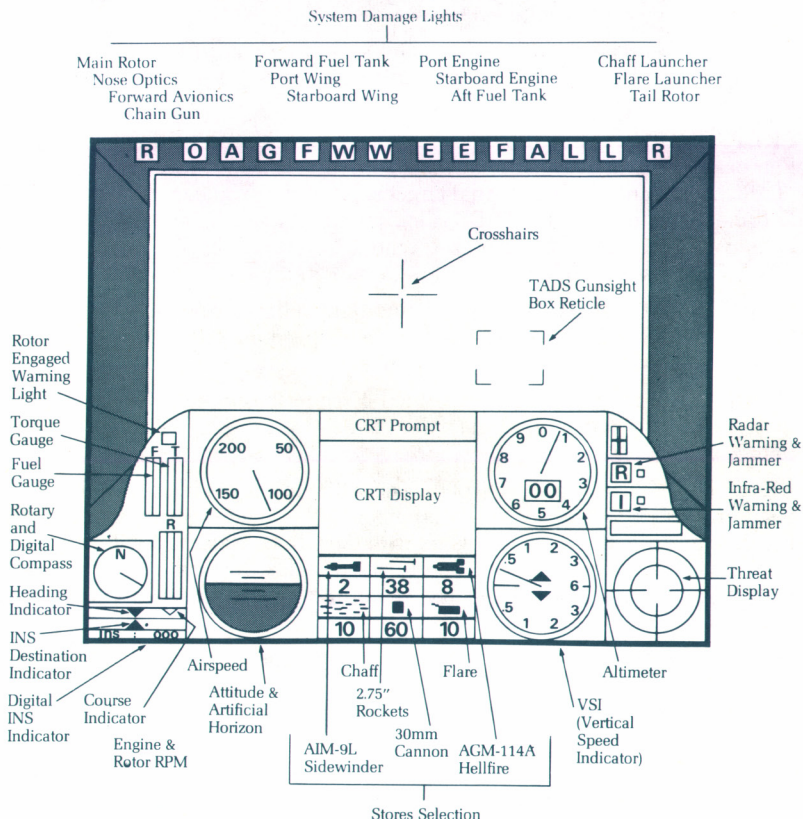

AIRPEED: This dial shows your horizontal speed through the air in knots. A speed of 100 knots equals about 114 mph, or about 167 feet/second.

ALTIMETER: This dial shows your altitude in feet. The rotary needle is marked in tens of feet (i.e., if the needle points to “1”, read it as 10 feet). The digital readout in the center shows your altitude to thousands (left digit) and hundreds (right digit) of feet. For example, a digital readout of 13 and needle at 6 means one thousand, three hundred, and sixty (1360) feet.

ATTITUDE & ARTIFICIAL HORIZON: This ball-gauge shows your pitch (nose up or down) and your roll (left or right). The blue part represents the sky, the black part the ground.

CRT DISPLAY: This small display screen has three separate modes of operation. The *TADS Target Mode* shows a zoom-camera view of the target on which TADS is “locked”. The display also shows the range to target (in kilometers) in the upper left corner and the zoom magnification in the upper right. For example, “1.2” and “x32” indicates the target is 1.2 kilometers (1200 meters) away and that your CRT view is magnified 32 times.

The *Map Mode* shows a small detail of the large sector map. This detail is centered on your helicopter. The only exception is when your helicopter is flying near or along the edge of the combat area.

The *Radio Message Mode* shows a radio message you just received. Once a message is displayed, it disappears. The display does not “remember” previous messages.

CRT PROMPT: This line prompts you whenever new information is available. For example, when a radio message arrives, “RADIO MSG” appears here. “TARGET” means a new potential target is present — you can use the TADS to find the new target. If your TADS is locked on a target, the name of that target appears here. Once TADS is locked onto a target and displaying its type, the “TARGET” message no longer appears, even if another target is available.

ENGINE & ROTOR GAUGES: The left and right yellow strips show the RPMs of the port (left) and starboard (right) engines. The center yellow strip shows the main rotor RPM (revolutions per minute).

FUEL GAUGE: The two yellow strips titled “F” show the amount of fuel remaining in the forward and aft tanks. The forward tank is the left gauge, the aft tank is the right gauge.

HEADING & COURSE INDICATORS: The white arrow represents your current heading (facing), and always remains centered. The green arrow represents your current course. Normally it is aligned with the white arrow, but will shift left or right if you’re skidding sideways. The red arrow beneath represents the course to your current destination. When the green, red and white arrows are superimposed, you are on course.

INFRA RED (IR) WARNING & JAMMING LIGHTS: The “I” warning light turns red whenever an infra red (IR) signature weapon is approaching your helicopter. If you turn on your IR jammer, the neighboring light turns green while the jammer is running. If the jammer is successful, the red warning light turns off.

There are no enemy IR searching devices, and therefore no flashing red IR warning.

INS DESTINATION INDICATOR (INS = Inertial Navigation System): This digital readout indicates the course to your current destination. When the INS readout matches the digital compass readout, you are on course.

RADAR WARNING & JAMMING LIGHTS: The “R” warning light flashes red whenever enemy search radar “sweeps” over your helicopter. When enemy tracking (firing) radar for either guns or missiles locks onto you, the light turns solid red. If you turn on your radar jammer, the neighboring light turns green while the jammer is running. If the jammer is successful, the solid red warning light turns off.

Note: Your jammer cannot discourage radar searches, so flashing red warnings may continue even if your jammer is successful in stopping a tracking (firing) radar.

ROTARY & DIGITAL COMPASS: The needle on this compass indicates your current heading, with a digital readout directly below. Note that the compass shows the heading your helicopter *faces*. During a sideways skid or backwards flight your actual course is different.

ROTOR DISENGAGED WARNING LIGHT: This light shows red if the rotor is disengaged (i.e., spinning freely, unconnected to the engines). The light is off when the rotor is engaged.

STORES SELECTION: The AH-64 Apache can carry up to six different types of dispensable stores (offensive and defensive expendables). Each has a different colored light, with the number of “units of fire” shown beneath (a unit of fire is how often you can use that item before you run out). Inactive stores are unlighted.

Only one offensive weapon can be armed at a time. The weapon currently ready is lighted. Offensive weapons can include:

- AIM-9L Sidewinder air-to-air guided missiles
- 2.75” FFAR unguided air-to-ground rockets
- AGM-114A Hellfire air-to-ground guided missiles
- 30mm Chain Gun Cannon (in 20-round bursts)

Defense stores light up when used. The light remains on as long as the defense is functioning (about 10-20 seconds). Defensive stores can include:

- Flare decoys to use against IR-guided weapons
- Chaff decoy to use against radar-guided weapons

As a point of information, each defensive store unit of fire is a group of three cartridges.

SYSTEMS DAMAGE LIGHTS: These lights show the status of major systems on board your helicopter. A green light means the system is functioning correctly, a colored light means the system is malfunctioning. Reading from left to right, the systems are:

- R main rotor
- O nose optics (controls TADS)
- A forward avionics bay (gauges)
- G chain gun (30mm cannon)
- F forward fuel tank
- W port weapons wing
- W starboard weapons wing

E port engine
 E starboard engine
 F aft fuel tank
 A Aft avionics bay (jammers)
 L chaff decoy launcher
 L flare decoy launcher
 R tail rotor (controls rotation)

THREAT DISPLAY: This screen shows nearby enemy weapons that threaten your helicopter. Red dots are enemy guns and launchers tracking or firing on your helicopter. White dots are missiles in flight. This includes both enemy missiles AND your missiles. A red-and-white flashing dot is an enemy helicopter. The top of the threat display represents your heading (i.e., "ahead").

The threat display operates at two ranges: long and short. Normally the display shows "long" range with two concentric circles. The inner circle shows local enemies (closer than 3 kilometers), the outer circle distant enemies (who are generally beyond your maximum visibility).

If an enemy missile or helicopter approaches within a few hundred meters, the threat display automatically switches to "short range" while the threat is close. This aids you in maneuvering against enemy helicopters, and/or to evade missiles.

TORQUE GAUGE: The two yellow strips titled "T" show the amount of torque in the port (left) and starboard (right) jet turbine engines. This is proportional to the collective control and rotor lift. The higher you set the collective, the higher the torque, and the greater the lift.

VSI (Vertical Speed Indicator): This dial shows the rate you are changing altitude (ascending or descending). If the needle is horizontal, you are maintaining a constant altitude. If the needle dips downward, you're descending toward the ground; if it points upward, you're ascending. The dial is marked in thousands of feet per minute. For example, if the needle points down at "1", then you are descending at 1000 feet per minute.

SECTOR MAP

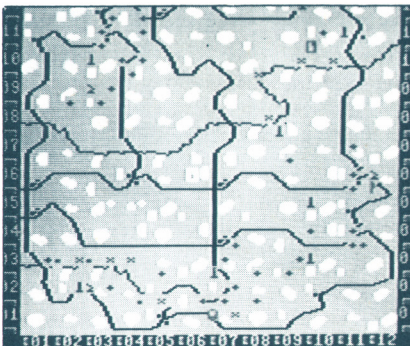

You can "look away" from the cockpit view to a large sector map. This map shows the local combat or training area, including all major terrain features, friendly troops, installations and your objective. Enemy troops and installations appear only as you spot them using the TADS gunsight. Enemy helicopters never appear on the map. They move too quickly for accurate marking. Remember that maps are never 100% accurate. Troop and base positions are especially prone to error.





STILL IN FLIGHT: You are still in flight while examining this map. Be sure to look up periodically. Otherwise you might fly into a mountain or come under attack. It's wise to hover in a safe place if you spend long periods examining this map.

INS CURSOR (INS = Inertial Navigation System): The white crosshairs on this map represents your current destination. Move the joystick to move the crosshairs. When you return to the cockpit, the INS indicators will help you fly to this destination.

GRID COORDINATES: The map uses a military grid coordinate system. To describe any position, read "right and up." That is, the first two digits are from the horizontal scale, the last two from the vertical scale. Therefore, 01-01 is the lower left corner, 01-12 is the upper left corner, 12-01 is the lower right corner, and 12-12 is the upper right corner.

ACCELERATED TIME: The accelerated time option is available only while viewing the sector map. Time passes at double the normal rate, thus halving your flying time between points.

MAP TERRAIN SYMBOLS include the following:

	Road
	Stream
	Building
	Hill
	Cultivated Area (Field, Rice Paddy, Plantation, etc.)

MAP TROOP SYMBOLS are in white for friendly forces, red for enemy, and purple for objectives.

	Infantry on foot and/or in foxholes
	Armored vehicle (tank, personnel carrier, etc.)
	Bunker (made of earth, steel and/or concrete)
	Anti-aircraft (AA) gun sites or vehicle
	Surface-to-air missile (SAM) vehicle
	Helicopter base
	Supply depot
	Headquarters

STORES STATUS DISPLAY

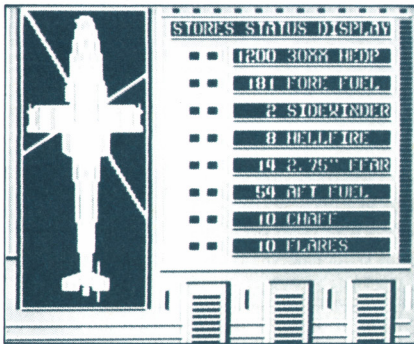

This console displays the stores on your helicopter. Status lights are green if the system is functioning correctly, yellow if damaged, red if destroyed. The view of the helicopter on the left side of the console shows each system appropriately colored.

STILL IN FLIGHT: You are still in flight while examining this display. Be sure to look up periodically. Otherwise you might fly into a mountain or come under attack. It's wise to hover in a safe place if you spend long periods examining this display.

30mm HEDP: Ammunition for the 30mm Chain Gun cannon. It uses HEDP (high explosive dual purpose) ammunition that is effective against all targets except bunkers which it can destroy only occasionally. The number indicates the actual number of rounds left. (Each cannon burst is 20 rounds, therefore with 1200 pounds you have 60 units of fire.)

FORE FUEL: This is the 156-gallon forward fuel tank.

AIM-9L: These are air-to-air "Sidewinder" infra red guided missiles.

AGM-114A: These are air-to-ground "Hellfire" laser-guided missiles. The Hellfire has an armor-piercing warhead for use against vehicles and bunkers.

2.75" FFAR: These are air-to-ground unguided rockets. The FFAR has a high explosive warhead for use against infantry, AA gun sites and installations.

AFT FUEL: This is the 220-gallon rear fuel tank.

CHAFF: This is the number of chaff decoy cartridges in the tail-boom launchers. Decoys are launched in groups of three.

FLARES: This is the number of flare decoy cartridges in the tail-boom launchers. Decoys are launched in groups of three.

SYSTEMS DAMAGE

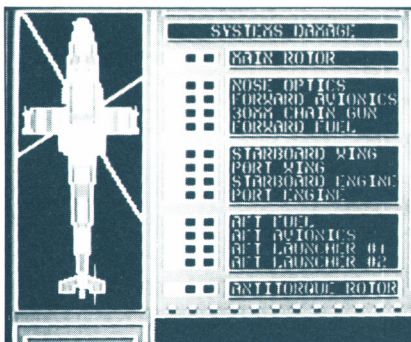

This console displays the major systems on your helicopter. The indicator lights show green if the system is functioning correctly, yellow if damaged, red if destroyed. The view of the helicopter on the left side of the console shows each system appropriately colored.

STILL IN FLIGHT: You are still in flight while examining this display. Be sure to look up periodically. Otherwise you might fly into a mountain or

come under attack. It's wise to hover in a safe place if you spend long periods examining this display.

AFT AVIONICS BAY: This compartment contains the INS navigation computers, and the IR and radar jammers. Damage can make some of this equipment erratic or unreliable; destruction could eliminate it all.

AFT FUEL TANK: This is the rear 220-gallon fuel tank. Damage often causes fuel leaks. If the tank is destroyed all fuel is lost and the helicopter may explode.

ANTI-TORQUE (TAIL) ROTOR: This rotor keeps the helicopter from spinning uncontrollably. If the tail rotor is damaged the helicopter may wobble or rotate, making flight control difficult. If the tail rotor is destroyed the helicopter spins out of control.

CHAFF & FLARE LAUNCHERS: The chaff and flare decoy launchers are housed in the tail boom. If a launcher is damaged some or all decoy cartridges may not function correctly. If a launcher is destroyed all cartridges are lost.

FORWARD AVIONICS BAY: This compartment contains computers and monitoring equipment for flying the helicopter. Damage or destruction can cause the strip gauges and/or round dials to disappear or freeze.

FORWARD FUEL TANK: This tank contains up to 156 gallons of fuel. Damage often causes fuel leaks. If the tank is destroyed all fuel is lost and the helicopter may explode.

30mm CHAIN GUN: This is the automatic cannon mounted beneath the nose. If the cannon is damaged it may fire erratically; if destroyed it cannot fire at all.

MAIN ROTOR: This keeps your helicopter airborne. Damage causes the helicopter to vibrate and wobble while flying. If the rotor is destroyed, or a damaged rotor comes apart, the helicopter will crash.

NOSE OPTICS: This is the heart of the TADS gunsight system. Damage can cause the TADS gunsight to work erratically. Loss of the nose optics destroys TADS, making it impossible to fire accurately.

STARBOARD & PORT WINGS: All rockets and missiles are mounted on these weapons wings. Damage causes the weapons to function erratically; if destroyed the weapons on the wing are lost.

STARBOARD & PORT ENGINES: Normally the rotor is powered by both engines combined. However, the helicopter can fly with one engine out. If an engine is damaged or destroyed it automatically shuts down and cannot be restarted until repaired (this minimizes the risk of fire or explosion).

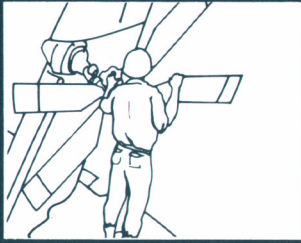

A PRACTICAL GUIDE to Flying Helicopters

AN INTRODUCTION TO HELICOPTER CONTROLS

When learning to fly use this description in conjunction with the section "Beginner's Tutorial 1 — Learning to Fly a Helicopter". See "Aerodynamics" for a more precise and detailed discussion of controlling helicopter flight.

BASIC CONCEPTS: The two main flight controls are the *cyclic joystick* and the *collective*. The *cyclic joystick* controls the pitch ("nosing" up and down) and roll ("leaning" left or right) of the helicopter. The *collective* changes the angle of attack of the rotor blades (see "Aerodynamics" for details). This changes the lifting force of the blades.

The *cyclic joystick* is controlled with your joystick except on computers using mouse control (where the mouse can move the cyclic joystick). Keyboard control of the *cyclic joystick* is available on the IBM PC.

The *collective* is controlled from the keyboard. On computers with a mouse, the mouse can be used to move the collective up and down as desired.

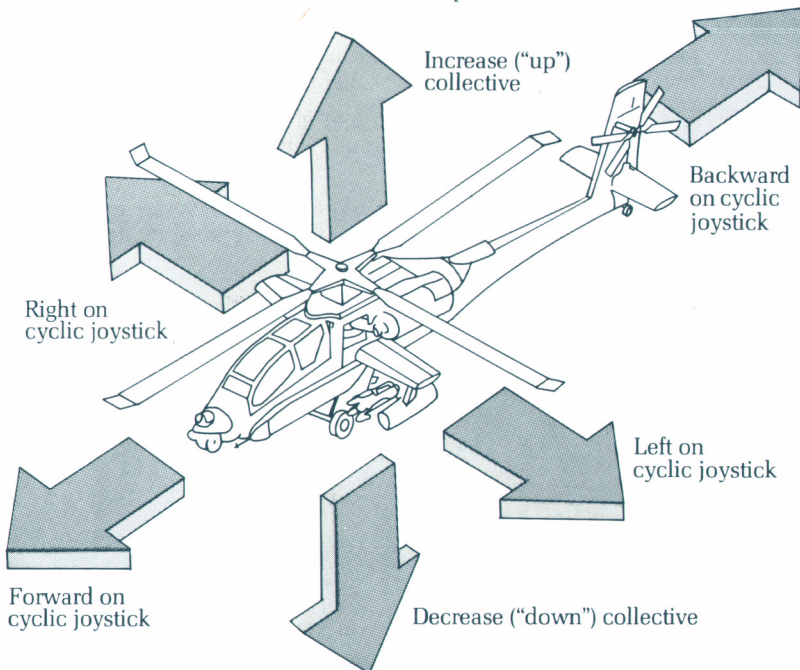

Pushing the *cyclic joystick forward* pitches the helicopter downward (“nose down”). This causes the helicopter to gain forward speed. The helicopter will NOT dive until it reaches a steep pitch downward, then it dives like a normal aircraft.

Pulling the *cyclic joystick back* pitches the helicopter upward. If the helicopter's pitch is upwards (the crosshairs are above the horizon) the helicopter will go backwards. Pitching upward does not necessarily mean you will climb! A common mistake of novices is to assume that the harder they pull back on the *cyclic*, the faster they will climb. Instead of climbing fast, they end up flying backwards! Watch the crosshair/horizon position to avoid this error.

Pushing the *cyclic joystick left or right* rolls the helicopter in that direction. At low speeds (under 40 knots) the helicopter skids sideways. At faster speeds it performs a banking turn like an aircraft. In either case, the further you roll, the more your lift decreases. Novices in level flight are often surprised by the loss in altitude as they roll left or right.

Moving the *collective up* increases the amount of lift in the rotor. If you are in level flight, the higher *collective* causes you to ascend. The torque will increase as you raise the *collective*. When torque reaches the maximum value on the gauge you are at maximum lift.

Moving the *collective down* decreases the amount of lift in the rotor. If you are in level flight, the lower *collective* causes you to descend. The torque decreases as you lower the *collective*. Except in unusual conditions, you cannot maintain level flight, much less ascend, if torque is below 50%.

Anti-torque (tail) Rotor Controls: These controls function *only* if the helicopter is moving very slowly (just a few knots) or hovering. Each tap on *rotate left* speeds up the tail rotor and causes the nose to swing left. Each tap on *rotate right* slows down the rotor and causes the nose to swing right. Tap *stop rotation* to return the tail rotor to normal speed, ending all rotation.

EASY vs. REALISTIC FLIGHT

When you start GUNSHIP, one of the reality options is a choice between “easy” simplified flight and “realistic” flight. MicroProse recommends realistic flight because once you learn it controls are more flexible and useful, especially at high speeds. However if realistic flying is too frustrating, try easy flight instead.

EASY FLIGHT: Here neither the pitch, roll, altitude nor airspeed of the helicopter has any effect on lift. This means that regardless of how you maneuver the *cyclic joystick*, lift is unaffected. Power dives are prohibited.

The *collective* is the only control that affects lift in easy flight. Anytime you want to add lift (to climb, slow your descent, etc.) tap the *collective up* fast or slow, as appropriate. Anytime you want to reduce lift (to slow your ascent, begin or increase a descent, etc.) tap the *collective down* fast or slow, as appropriate.

REALISTIC FLIGHT: Here the pitch, roll, altitude, and airspeed affect lift as in a real helicopter. **Ground Cushion Effect:** At altitudes of 25' or less you gain a little extra lift at low speeds. The lift gained varies with altitude, and disappears entirely if you're flying too fast. **Translational Lift:** At speeds of 30 to 90 knots you

gain considerable extra lift. The amount varies with the speed. **Roll & Lift:** With any significant amount of roll, the helicopter loses some lift. The lift loss increases as the helicopter rolls further left or right. **Altitude:** At higher altitudes you have less lift due to the thinner air. The lift loss increases as you get higher and higher. This loss is only noticeable above 1,000 feet.

Among other things, the use of realistic flight means that at high speed you can fly the helicopter not unlike an airplane. A slight pitch up slows the helicopter and causes a climb (by reducing speed into the 30-90 knot area for maximum translational lift), while a steep pitch down puts the helicopter into a fast power dive.

INTRODUCTION TO HELICOPTER FLIGHT

This section gives a rudimentary view of common concepts in helicopter flight. For a more complete and detailed description of how and why helicopters fly, see the "Aerodynamics" section.

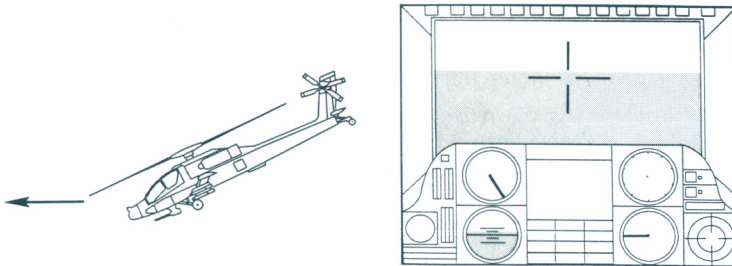

LEVEL FLIGHT FORWARD: In level flight the helicopter is pitched down ("nose down"). The greater the pitch, the faster the forward flight. Note that in forward flight the crosshairs are *always* below the horizon line. The VSI gauge is horizontal (reading zero), indicating flight is level. In combat flying, typical level flight speed is 100 to 150 knots.

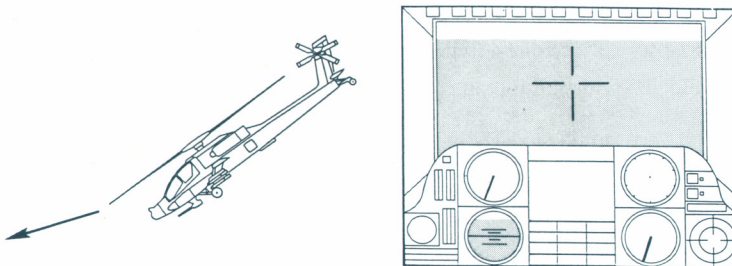

POWER DIVE: In a power dive the helicopter is pitched down steeply. The crosshairs are significantly below the horizon line, and the VSI gauge needle is pointing downward. Power dives usually require speeds greater than 160 knots.

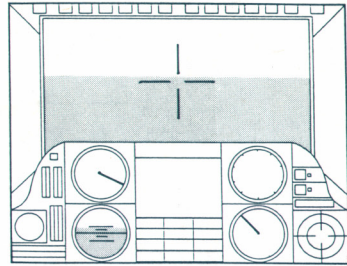

FORWARD CLIMB: When climbing in forward flight, the helicopter is travelling slower than normal (pitch is still present, but smaller than normal), or the *collective* control (and engine torque) is higher than normal, or both. The VSI gauge needle is pointing upward. Forward climbs are easiest at speeds of 30 to 90 knots.

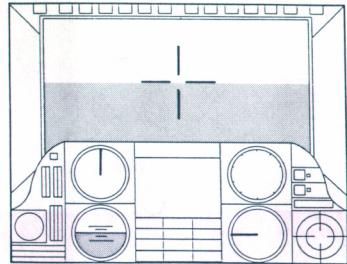
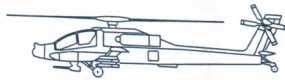

HOVER: Here the helicopter is truly level, with no pitch down or up. Note that the crosshairs are on the horizon line and airspeed is zero (needle is vertical). The *collective* is adjusted so the VSI gauge is horizontal (zero). From a hover a helicopter can ascend straight upwards or descend straight downwards by changing the *collective*.

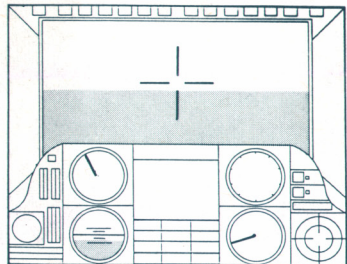
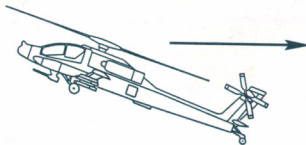

BACKWARDS FLIGHT: When flying backwards the helicopter is pitched upwards. Note that the crosshairs are above the horizon — which only occurs when flying backwards. The airspeed gauge shows the speed backwards. Depending on the speed and amount of *collective*, the helicopter could be ascending, flying level, or descending while moving backwards.

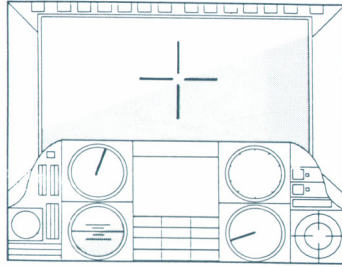
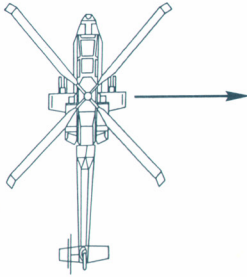

SKID SIDEWAYS: This is only possible at low speeds (under 40 knots) or when hovering. The *cyclic joystick* is moved left or right to roll the helicopter. Due to a lack of airspeed, the helicopter skids left or right without forward motion. Unless the *collective* is adjusted appropriately, a skidding helicopter loses some lifting power.

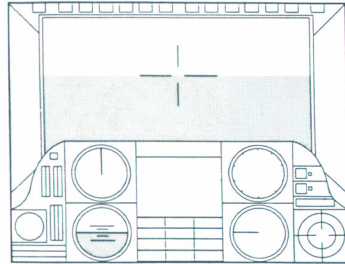
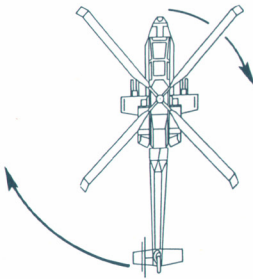

ROTATE LEFT OR RIGHT: This is only possible at *extremely low* speeds or when hovering. The *anti-torque* (tail or “rudder” controls) rotates the helicopter left or right. Rotation does not affect airspeed or VSI. The *cyclic joystick* and *collective* are not used when rotating.

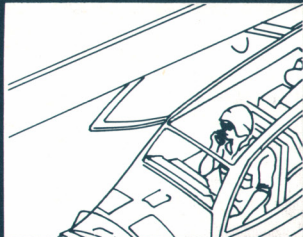

CONTROLS

on the AH-64A Apache Simulator

FLIGHT CONTROLS

This section defines how each control works. Do not use this section as a guide to flying a helicopter. To learn to fly, follow "Beginner's Tutorial #1 — Learning to Fly a Helicopter".

THE KEYBOARD OVERLAY: An overlay appropriate to your computer keyboard is included with the simulation. The control placement is designed for use with this overlay — don't lose it!

Note: Computers sometimes misread multiple key inputs. Unless otherwise indicated, do not press two keys simultaneously. Do not push the joystick while holding a key. Pushing the joystick while holding a key may cause weird effects on C64/C128 computers.

CYCLIC JOYSTICK: Pushing forward pitches down the helicopter ("drops the nose"). Pulling back pitches up the helicopter ("raises the nose"). Pushing left or right rolls the helicopter in that direction ("tilts" the rotor and body left or right).

A pitch below horizontal moves the helicopter forward. A large pitch down causes a power dive. Pitch up above horizontal moves the helicopter backward. Rolling left or right at low speed causes a skid (or "sideslip") left or right. At medium and high speeds it causes a banking turn left or right.

The artificial attitude and horizon indicator shows the current pitch and roll of the helicopter.

Summary: Forward = *pitch down* ("nose down")
for C64/C128 Backward = *pitch up* ("nose up")
Right = *roll right* (bank or skid right)
Left = *roll left* (bank or skid left)

COLLECTIVE: This control can be moved *up fast* (increases lift by large amounts) or *down slowly* (decreases lift by small amounts). When you raise or lower the collective, the engine torque changes appropriately. To move the collective a large amount, tap it repeatedly and quickly.

Lift keeps the helicopter airborne. If you start in level flight or hover, then increase lift, the helicopter ascends. If you start level and decrease lift, the helicopter descends.

Summary: F1 = *up fast*
for C64/C128 F3 = *up slow*
F5 = *down slow*
F7 = *down fast*

ANTI-TORQUE (TAIL) ROTOR: These function only when hovering or moving extremely slowly (just a few knots). Tap *rotate left* to swing the nose left. Tap *rotate right* to swing the nose right. Multiple taps on the key increase the rate of rotation. Tap *stop rotation* to eliminate all rotation.

Summary: CRSR up/down = rotate left
for C64/C128 CRSR left/right = rotate right
 RETURN = stop rotation

PORT or STARBOARD ENGINE ON/OFF: Tap the appropriate key to turn on (if currently off) or turn off (if currently on) each engine. You must turn off the engines to finish your flight.

If an engine is damaged or destroyed it turns off automatically. You cannot restart the engine until it is repaired.

Summary: 1 = port engine on/off
for C64/C128 2 = starboard engine on/off

ROTOR ENGAGE/DISENGAGE: Tap this key to either engage the rotor (cause the engines to turn the rotor), or disengage the rotor (cause the rotor to spin freely, unconnected to the engines). When the rotor is disengaged, the collective is automatically "bottomed" (dropped to zero).

Summary: 3 = rotor engage/disengage
for C64/C128

VIEWING CONTROLS

CHANGE CRT: The CRT has three display modes. Each tap on this key switches the CRT to the next mode. These modes are:

- (1) TADS target mode
- (2) Map mode
- (3) Radio message mode

If no target is ahead of the helicopter, the TADS target mode does not appear. If no new radio message is available, the radio mode does not appear. If neither a target nor a radio message is available, then the CRT is always in map mode.

Summary: Space Bar = change CRT
for C64/C128

MAP: Tap this key to see the full sector map. You continue flying, so beware of flying into something while examining this display. Tap this key again to return to the standard cockpit view.

Summary: Z = map
for C64/C128

STORES: Tap this key to see the stores display. It shows the status of systems with stores, including the amounts remaining. You continue flying, so beware of flying into something while examining this display. Tap this key again to return to the standard cockpit view.

Summary: Commodore logo = stores
for C64/C128

DAMAGE: Tap this key to see the systems display. It shows each system and whether it's functional, damaged, or destroyed. You continue flying, so beware of flying into something while examining this display. Tap this key again to return to the standard cockpit view.

Summary: SHIFT (left side) = *damage*
for C64/C128

VIEW: The view center key shows your view directly ahead. The view left key shows your view diagonally ahead to the left. The view right key shows your view diagonally ahead to the right. Due to the engines, transmission, and rotor shaft your rearward view is blocked. Note that the crosshairs are present only on the center view.

Summary: £ = *view left*
for C64/C128 CLR HOME = *view center*
INST DEL = *view right*

COMBAT CONTROLS

GO TO TADS TARGET MODE: If the CRT is not displaying a TADS target, but the prompt "TARGET" is showing, tap the fire button to switch the CRT to TADS. You can also use the standard *Change CRT* control.

NEW TADS TARGET: Tap this key to move the TADS gunsight box from one target to another, showing the new target in the CRT. If no other targets are present directly ahead TADS remains on the original target.

Summary: SHIFT (right side) = *new TADS target*
for C64/C128

WEAPONS: Tap the appropriate key to select one of the four possible weapons: AIM-9L Sidewinder missiles, 2.75" FFAR rockets, AGM-114A Hellfire missiles, or the 30mm cannon.

Summary: 4 = *AIM-9L Sidewinder missiles*
for C64/C128 5 = *2.75" FFAR rockets*
6 = *AGM-114A Hellfire missiles*
7 = *30mm cannon*

FIRE: Tap the fire button on the cyclic joystick to fire the weapon currently selected. Each tap fires one missile (Sidewinder or Hellfire), a pair of rockets, or a burst of 20 cannon rounds.

Summary: joystick fire button = *fire*
for C64/C128

DROP CHAFF or FLARE DECOY: Tap the appropriate key to release the appropriate decoy. The cockpit indicator remains lighted as long as the decoy is functioning.

Summary: 9 = *drop chaff decoy*
for C64/C128 - = *drop flare decoy*

RADAR or IR JAMMER ON/OFF: Tap the appropriate key to turn on (if currently off) or off (if currently on) the jammer. When the radar jammer is running you see a green light beside the "R" warning light. When the IR jammer is running you see a green light beside the "I" warning light.

Summary: 0 = *radar jammer on/off*
for C64/C128 + = *IR jammer on/off*

JETTISON STORES: To jettison all ammunition for a particular weapon hold down the select weapon key and tap *Jettison*. This dumps all the Sidewinders, rockets, or Hellfires, depending on which weapon you select. For example, to jettison all your FFAR rockets in the C64/C128 version, hold down the "5" key and tap "RESTORE".

Summary: 4 [+] RESTORE = *jettison Sidewinders*
 for C64/C128 5 [+] RESTORE = *jettison 2.75" FFAR*
 6 [+] RESTORE = *jettison Hellfires*

SIMULATION CONTROLS

ACCELERATED TIME: This key doubles the speed of time, thus shortening flight time from one point to another. This function works **ONLY** if you are viewing the sector map. It automatically turns off when you return to the standard cockpit view.

Summary: Left Arrow = *accelerate on/off*
 for C64/C128

PAUSE: This key freezes the simulation. Tap any key to resume the simulation.

Summary: RUN STOP = *pause*
 for C64/C128

RESET: Hold down these keys to restart the simulation. On the C64/C128 hold down the RUN STOP key and then tap RESTORE. In effect you are "jettisoning" the entire mission.

Summary: RUN STOP [+] RESTORE = *reset*
 for C64/C128

ANSWER THE RADIO!

When you see the prompt "MESSAGE" above the CRT, tap the *Change CRT* once to read the incoming radio message. Ignoring messages can be detrimental to your health!

PASSWORD & COUNTERSIGN: As you approach your friendly base, you will get a radio message. It's **VITAL** that you read and answer this message! Tap *Change CRT* to display the message on the CRT. You will be radioed the password and asked for the countersign. You must type the proper countersign at the keyboard and press "RETURN".

Passwords and corresponding countersigns are listed (alphabetically) at the bottom of selected pages in this manual. Look up the countersign and type it onto the screen. Press RETURN when you are done. If you don't, your base will assume you're hostile and shoot you down!

Controls Summary		
Category	Action	C64 / C128
Cyclic	Pitch down Pitch up Roll left Roll right	Stick forward Stick back Stick left Stick right
Collective	Up fast Up slow Down slow Down fast	F1 F3 F5 F7
Anti-torque (tail) rotor	Rotate right Rotate left Stop Rotation	Horizontal cursor Vertical cursor RETURN
View	View Left View Forward View Right	£ CLRHOME INST DEL
Engines	Port on/off Starboard on/off Rotor eng./diseng.	1 2 3
Weapons	Sidewinder 2.75" FFAR Hellfire 30mm cannon	4 5 6 7
Fire	Fire weapon	Stick button
Jettison	(with weapon)	(weapon) and RESTORE
Counter- Measures	Chaff decoy Flare decoy Radar jammer IR jammer	9 - 0 +
Viewing Other Displays	Map Damage Stores	Z [left] shift Commodore
CRT	Change CRT	space bar
TADS	New TADS Target	[right] shift
Simulation	Accelerated Time Pause Reset	left arrow RUN STOP RUN STOP and RESTORE

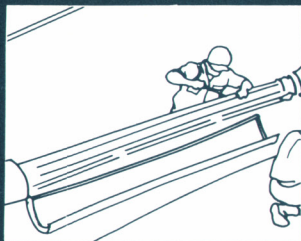

BEGINNER'S TUTORIAL I

Learning to Fly a Helicopter

This tutorial teaches you how to take off, control the helicopter in basic flight maneuvers, and land again. Refer to “Cockpit & Status Panels” to understand what’s appearing on the screen. Refer to “Controls” and the keyboard overlay to find the appropriate controls. Glance over “A Practical Guide to Helicopter Flying” for additional insights and illustrations.

This tutorial is for use with the “realistic” flight mode, not the “easy” flight mode. MicroProse recommends that you learn and fly in the realistic mode from the start (you’ll appreciate the advantages later). You can always “fall back” on the easy mode if the realistic mode becomes too frustrating.

The second tutorial will cover your weapons and defenses. For more detail about how a helicopter flies and how to perform advanced tactical maneuvers, see the “Aerodynamics” and “Weapons & Tactics” sections.

WARNING - DON'T OVERCONTROL: Helicopter controls are SLUGGISH (ask any helicopter pilot!). That is, they react slowly. Even a frisky thoroughbred like the Apache takes one to two seconds to respond to your control movement. Therefore, just tap a key and see what happens. When using the joystick, move it a little, then let it go. The most common error in flying is to overcontrol by pulling hard on the stick or pressing too long and hard on a key.

In short, be gentle with the controls. After each control movement watch for the result before you do anything else. Numerous fast, radical control movements will produce incomprehensible results and probably a crash!

STARTING: Take the vehicle identification test, enter your name on the pilot roster, and make sure the region is set to “Training in the USA” duty assignment. Reality defaults should be set to “Realistic Flying”, “Easy Landing” and “Easy Weather.” Read the briefings and armament options, but don’t bother to change them. See “Preparing to Fly” for details on how to control the starting options.

PAUSE WHILE LEARNING: As you work through the tutorial, tap the *Pause* key whenever you want to read about the next maneuver or explanation. Then tap any key to resume, try the maneuver, then pause again as you read the next part of the tutorial, etc.

ATTACKS: Don’t worry about enemy attacks and firing while learning to fly. In training situations the enemy always fires “blanks” — you cannot be damaged or destroyed by enemy fire. On your first training flights you should ignore enemy activity. In the next tutorial you’ll learn how to respond to enemy attacks, and how to hit targets.

POWER UP: Turn on the port and starboard engines by tapping *Port Engine On/Off* and *Starboard Engine On/Off*. Wait until the engine RPM strip gauges climb to normal (about the 80% point). Then tap *Rotors Engage/Disengage* once.

The rotor engaged warning light, previously red, should turn off. You'll hear the rotors come up to speed. Wait until the middle strip gauge (rotor RPM) climbs to normal (slightly above the engine RPM levels).

CLIMB TO A HOVER: Now repeatedly tap *Collective Up Fast*. Watch the torque rise as you "raise" the collective. Note that if you "lower" the collective, the torque drops. Once the torque reaches 75% use the *Collective Up Slow* key until you rise off the ground (at about 80-95% torque, depending on how close your weight is to the maximum). You should be hovering at about 12 feet altitude.

ROTATING IN A HOVER: Tap the *Rotate Right* once. Your helicopter begins to rotate to the right. Tap *Stop Rotation* once and you'll stop turning. Tap the *Rotate Left* to rotate in that direction. If you tap either rotation key repeatedly, the helicopter rotates faster in that direction. You can only use rotation when you are moving just a few knots, or stationary.

Now stop the rotation. You're ready to begin flying.

Takeoff and Forward Flight

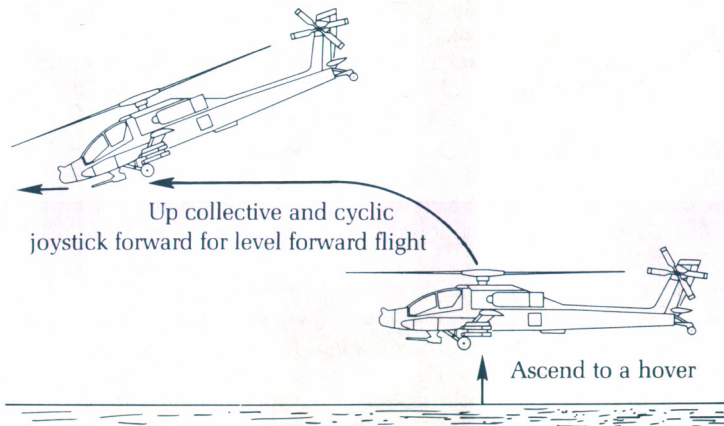

FORWARD FLIGHT: Add a little more *collective up slow*. As you begin climbing push forward lightly on the *cyclic joystick* to "pitch down" the helicopter. You'll begin to move forward. At about 30 knots you'll begin to climb. You can see this on your altimeter (upper right dial) and your VSI (lower right dial) gauges. This is because forward motion in a helicopter adds extra lift (termed "translational lift"), especially at 30-90 knots.

The further you pitch down, the more your speed increases. As your speed exceeds 100 knots, translational lift decreases. The VSI gauge will move toward the negative end of the scale. More pitch downward will push you into a power dive at 160-200+ knot speeds.

LEVEL FLIGHT: Move the joystick forward or back until the airspeed gauge reads 100 to 150 knots. Now look at the VSI. If you're descending (the needle is below horizontal) add some *Collective Up Slow* until the needle is on "0" (horizontal). Alternately, if you're ascending, put in some *Collective Down Slow*. When the VSI needle is horizontal (reading zero), you are in level flight.

Remember, due to the slow responses of helicopter controls, it's easy to over-correct and put in too much collective. This results in you "chasing the needle". After each change in the collective, wait a second or two for the VSI needle to stabilize.

CHANGING ALTITUDE: When flying level at 100-150 knots, the easiest way to descend is to push the *cyclic joystick* forward (pitch down) into a power dive. As you approach the altitude you desire, gently pull the *cyclic joystick* back (pitch up) until the VSI again stabilizes at zero (needle is horizontal). Similarly, the easiest way to ascend is to pitch up slightly, reducing your airspeed to 50-100 knots. When you reach the desired altitude, pitch down again until the VSI stabilizes.

This technique of flying is not unlike an airplane. You can change altitude without disturbing the collective. A second way to change altitude, applicable at *any* speed, is to raise or lower the *collective*. When you reach the new altitude, input an equal and opposite amount of *collective* to regain level flight (VSI of zero). This technique is the only way to change altitude from a hover.

Regardless of which technique you use, don't try to control the helicopter by constant "fiddling" with the collective. Learn to "feel" the right collective setting, then fly with your cyclic joystick. Don't expect to gain this ability on the first flight. Be patient. After a number of flights and landings you'll find collective adjustments come naturally — just like a real helicopter pilot.

LOW ALTITUDE TURBULENCE: While flying under 100', you may feel air turbulence. You will tend to bounce up and down, or sometimes roll from side to side. Air turbulence and "wind shears" vary with your speed and your distance from the ground: the faster and lower you fly, the more difficult it is to keep the craft under control.

TURNING: Return to level flight at 100-150 knots. Next push the stick left slightly and release it. Your helicopter rolls into a banking left turn. As you turn, observe the change in your digital heading readout (in the lower left of the cockpit display, just under the compass). If you continue to push the stick left and bank into a steep turn, you'll lose some lift. Notice that your altitude is dropping and the VSI is below horizontal. If you roll back to the right and level out, you'll return to level flight.

To maintain your altitude in a steep bank (important if you're flying low) add a bit of *Collective Up Slow* just before you start to turn, then put in a bit of *Collective Down Slow* just before you come out of it. Change the collective first because the collective controls react more slowly than the cyclic joystick.

NAVIGATION: Tap the *Map* key to see the full sector map. Your objective is to find your way home to base! Move the crosshair cursor to the central white helibase, then switch back to your cockpit view. Quite probably your heading and the INS heading are different. Make a banking turn toward the INS heading until the two numbers match. Notice that the INS arrowhead marker below your own course arrowhead will also match. You're on course, flying back to base. Descend until you're in level flight at 50 to 100 feet altitude. It's easier to learn to land if you come in slow and low, although "officially" a constant descent is preferred by air controllers.

LANDING: As you approach the base it first appears as an outline on the horizon. Reduce your speed to 60 knots by pulling back slightly on the *cyclic joystick*. You'll need to put in some *collective down slow* to maintain your 50' altitude. Now wait until the detailed buildings and landing "T" come into view. Your goal is to land directly on the "T", but anywhere within the larger rectangle is fine.

Just before you cross the outside edge of the base, begin slowing down to a hover by pulling up on the *cyclic joystick*. Be sure to put the crosshairs on the horizon — it's easy to pitch up too far and end up going backwards. Note that as your speed falls from 70 to 0 knots, your lift will decrease. Use the *collective up slow* to stabilize your altitude with zero VSI. By the time you accomplish all this and are hovering at about 50' altitude, you should be near the center of the base.

Finally, use the *cyclic joystick* carefully to move your helicopter toward the "T". Come back to a hover, and tap the *collective down slow* once to begin your final descent. At about 20' and/or 10' altitude you may need another tap to continue descending to a touchdown.

SHUT DOWN: When you land (altitude is zero) turn off both engines. This ends the flight; your postflight options will appear.

MISSION: After this first flight, your debriefing will show mission not yet accomplished. To satisfy your instructors, you must learn how to hit the target too. Go to "Beginners Tutorial II" to finish your training.

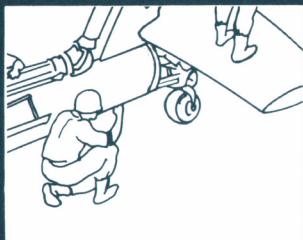

BEGINNER'S TUTORIAL II

Defense & Gunnery

This tutorial teaches you how to recognize and deal with various enemy missile (SAM) and gun (AA) attacks. It also gives you practice in using your own weapons against appropriate targets.

STARTING: If you have just finished the first Tutorial, you can use the same defaults again (same region, style of flying, and reality levels). The region should be "Training in the USA," style should be "Regular Missions," and reality should be "Realistic Flying," "Easy Landing" and "Easy Weather."

Note: When training in the USA, all missiles and gun shells fired at you are "blanks." You can never suffer damage from "enemy" fire while training. However, don't forget that everywhere else the enemy plays "for keeps."

MAKE A PLAN: Before takeoff examine the sector map of the training area. Pick one of the three dummy installations (HQ, Russian Heli-base, or the Depot) as your objective. Move the INS marker to that objective. Notice the "enemy" forces along or near the line of flight from your base to the objective. These are the "opponents" you will engage.

TAKEOFF: Take off and get into level flight at 100' altitude (digital readout on altimeter is "01").

THREATS: As you fly, watch the threat display on the lower right. A red dot means an enemy with AAA (anti-aircraft artillery) or SAMs (surface-to-air missiles) have detected you. A flashing red and white dot means an enemy helicopter is approaching. A white dot means a missile is flying (yours or an enemy's — the threat display cannot distinguish one missile from another). Also watch your warning lights. When the "I" turns red an IR homing missile is being launched. When the "R" is red radar-guided missiles or guns are either searching for or tracking you.

When enemies appear on your threat display they are also plotted on the map. If you have the time, you can look at the map to learn what type of enemy is attacking you. Though virtually every enemy has some sort of light guns or shoulder-launched missile (the SA-7, SA-7B or SA-14), the most dangerous are the AA gun sites and vehicles, or the SAM vehicles.

USING A JAMMER: When a warning light comes on, the standard response is to turn on the appropriate jammer (press the IR or Radar *Jammer On/Off* once). A small green light beside the warning light turns on, showing your jammer is running. If the warning light turns off, the jamming was successful. Now turn onto a new course. Jammed missiles often continue flying on their old course, and will hit you unless you change your course.

Keep your jammer running until you destroy or fly away from the enemy launcher or gun. In concentrations of enemies some pilots will turn on both

jammers and constantly fly a “jinking” zig-zag course to confuse missiles and enemy gunnery.

USING A DECOY: If the warning light does not turn off by jamming, try using a decoy. Tap *Drop Chaff* or *Drop Flare* to deploy decoys. The decoy symbol below the CRT will light up. While the symbol is lighted the decoy should be drawing the missile or gunnery control toward it.

Decoys are launched in three-cartridge “units of fire”. Although your cockpit control panel shows units of fire for convenience, the pre-flight arming and stores readout displays show actual cartridges available. If you check your stores display after launching a chaff of flare decoy, you’ll see the amount remaining has decreased by three.

EVASIVE FLYING: Another way to avoid a threat is to dive to a lower altitude while turning parallel to or away from the threat. If you get lower and avoid closing the range an enemy often loses sight of you. Enemy weapons aimed by eyeball (many AA guns and a few SAMs) cannot be jammed or decoyed. Against these threats evasive flying is your only defense. Another evasive technique is to slow your speed once you’re low. Slow movement at low altitude is very hard to spot at a distance. It is possible to “sneak up” on enemy positions with a helicopter.

Evasive flying is also superior to jammers and decoys because it doesn’t broadcast your position. Both jammers and decoys, not to mention firing, reveal your presence to the enemy.

DAMAGE: If you don’t respond in time to a threat, the gunfire or missile will hit you. You’ll see the flash of explosions around the edge of the cockpit. In training that’s all you’ll see — your helicopter cannot be damaged. In real battle, the explosion may penetrate your armor. If a system across the top of the cockpit is no longer green, something is malfunctioning. Check the damage display for details. Sometimes you’ll want to fly home for repairs before continuing your mission.

If you suffer too many damaging hits, the structural integrity of your helicopter will fail, causing a general power failure. The only way to survive this is to successfully “autorotate” to a landing (see “Aerodynamics” for details on autorotation). The actual number of hits varies with the situation and enemy weaponry, but a good rule of thumb is expect the worst after you’ve suffered three or four damaging hits.

USING TADS (Target Acquisition & Designation System): Look on your map and find a large concentration of red targets near your flight path. Fly in that direction. When you’re close pull up into a hover. Now use the *rotate right* and *rotate left* keys to turn your nose left and right. When the crosshair is close to a target, the prompt “TARGET” appears above the CRT. Press the *fire button* on the joystick. The TADS gunsight box will appear around the target while the zoom camera shows the target on your CRT. The range to target in kilometers appears in the upper left (for example, if the range is “0.8”, the target is 0.8 kilometers — 800 meters — away).

Tap *next TADS target* to shift the TADS to another target near the crosshairs. If there is no other target near the crosshairs, TADS remains on the original target. After TADS is locked onto a target you can rotate left or right and watch TADS track the target for you. As the box gets near the edge of your cockpit view tap the

View Right or View Left key as appropriate. Your view switches to the side. Notice that TADS continues to follow the target. As long as you can see the target TADS will follow it.

If the target leaves your field of view, TADS loses it and automatically unlocks. Unless there is another target near your crosshairs for TADS to lock onto, the CRT switches back to the map.

Cockpit Viewing Angles

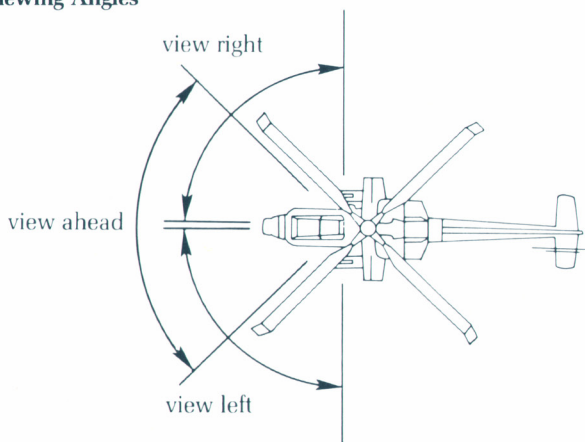

TADS can only lock onto targets you can spot. At low altitude (such as under 100') you can't see very far. Targets appear at very short ranges (just a few hundred meters away). The higher you are, the further you can see: TADS can lock onto targets at further and further ranges. Of course, the higher you are, the easier it is for enemies to spot you. As a result, helicopter pilots tend to fly low and occasionally "pop up" to locate enemies. A favorite maneuver is to "pop up" from behind a hill.

The 30mm Chain Gun cannon and the 2.75" FFAR rockets have varying accuracy, depending on range and whether the weapon faces ahead. The TADS box changes color from dark (poor accuracy) to light (good accuracy) with these weapons. The Sidewinder and Hellfire always have good accuracy, and therefore the TADS box is always light colored if one of these weapons is selected.

RADIO MESSAGES & MAP VIEWS DURING BATTLE: If the CRT target view interferes with your navigation, or you want to read a radio message, tap *Change CRT*, TADS turns off and the CRT switches the next available mode (see "Controls" for details).

FIRING WEAPONS: To fire you must first select a weapon. When you press the appropriate *Select Weapon* key, that weapon lights up beneath the CRT and the ammo supply appears in white. Cannon ammo is shown in 20 round bursts. Once a weapon is selected, to fire simply press the *Fire Button* on the joystick.

The **30mm Chain Gun** cannon is automatically aimed at the target designated by TADS (the AH-64A has a ballistic computer that aims the cannon for you). However, the cannon is more accurate firing straight ahead. The TADS box will

turn a brighter color as accuracy improves. Cannon maximum range is 1.5 kilometers, but the effective range is about 0.7 kilometers firing ahead, and only 0.3 to 0.4 kilometers in a "deflection shot" to the side.

The **AGM-114A Hellfire** anti-tank missile is guided by laser at the TADS target. As long as you keep TADS locked on target the Hellfire flies toward it. The Hellfire has a minimum range of a few hundred meters — it takes time for the missile to lock onto the TADS laser. The maximum range of the Hellfire is 6 kilometers. Furthermore, once beyond minimum range, Hellfire accuracy is unaffected by range.

The **2.75" FFAR rockets** are completely unguided. You must line up the crosshairs in the center of the TADS box, then fire. The rockets fly straight ahead at whatever was in the center of the crosshair when you fired. After the rockets are launched you need not keep the target in the crosshairs. The maximum range of FFAR rockets is about 1.8 kilometers, but accuracy improves at shorter ranges. As with the cannon, the TADS box will become brighter as your accuracy improves.

The **AIM-9L Sidewinder** is a "fire and forget" air-to-air homing missile. Lock the TADS onto a flying target and make sure the target is generally ahead (fairly close to the crosshairs). Then fire the missile. Once you fire, you can switch the TADS to something else and/or fly away. Enemy aircraft may have jammers or decoys that could cause a Sidewinder to miss. Maximum range of the L-model Sidewinder is 18 kilometers. Effective range against a helicopter is virtually equivalent to the maximum range.

WEAPON RESTRICTIONS: Certain weapons are only effective against certain targets. The 30mm cannon is effective against anything except bunkers which it can destroy only occasionally. The AGM-114A Hellfire is effective against "hard" targets (all vehicles and bunkers, but not other installations). The 2.75" FFAR rockets are effective against "soft" targets (infantry, AA gun sites, and installations — such as the HQ, Depot, and Russian Heli-base). The AIM-9L Sidewinder is effective only against flying targets. It is useless against any ground target.

RECOIL: When you fire a cannon or guided missile the helicopter bucks and recoils upwards. Be prepared to regain control quickly.

HITTING THE OBJECTIVE: Eventually you'll reach your objective. Lock the TADS onto the HQ, Heli-base or Depot and select the 30mm cannon. In actual combat, you'd fly straight in and open fire at 0.7 kilometers (closer if you're short of ammo). However, in training try "buzzing" over the target at 30' first. This will show you what the target looks like. Then circle around, lock on the TADS once more, and make a second pass with cannons blazing. If you want a real test of skill, don't use the cannon. Instead, make a rocket attack at 1.5 kilometers or so. You'll probably need to fire lots of rockets.

RETURNING TO BASE: After destroying the objective go back to the sector map and set your INS for your home base. Fly home, land, and shut down both engines. You can either rearm and refuel for another round of target practice, or you can call it quits here. A successful flight may qualify you for the *National Defense Service Medal*.



AFTER THE MISSION: Succeeding as Gunship Pilot

DEBRIEFING & SUBSEQUENT OPTIONS

ENDING A MISSION: You end a mission by landing, turning off both engines, and waiting for the rotor to stop. You then are told your status, and if you crash as a Sergeant or Warrant Officer you get the option to “retry” the flight instead of continuing. If you retry, you fly the same mission again. If you “continue” (this is automatic at higher ranks) you receive normal results.

Next you can decide whether to examine your craft, leave it, or (if at a friendly base) ask for more fuel, armament and/or repairs. If you select repairs the enemy will have time to bring up reinforcements. In some cases your situation or damage will prevent certain options.

After landing you are “debriefed” and may receive promotions or decorations appropriate to your performance. If you ignored your orders and failed to perform the mission assigned you could find yourself peeling potatoes for a while! (Your commanding officer dislikes being ignored!)

Finally, you'll see your current rank, decorations, and score compared to the two all-time top scoring pilots of the game. These all-time top scorers are saved on disk independently of the current roster, and can only be erased here.

REPLAY OPTIONS: If you decide to try another mission you can either remain in the same region, flying the same type of missions, or you can change your style of flying, or you can request a transfer to a new region. Alternately, you can put your career on “hold” and go on R&R (rest and recuperation). Pilots on R&R remain on the roster until you deliberately erase them.

ENDING THE SIMULATION: On the replay options screen you can end the simulation by removing the disk and turning off your computer. To ensure accuracy in your pilot roster and records, you should turn off the computer *only* when the replay options are showing.

SUCCESS

THE MISSION: If you leave the helicopter somewhere other than a friendly base, you could be captured by enemy troops. The chances naturally increase if you're deep in enemy territory.

As a good soldier, your duty is to complete the assigned mission. This means destroying the primary target. Destroying the secondary target as well is a definite plus. Sometimes your commander will change his mind during a mission and reassign the secondary target as your new primary target. Many missions have multiple targets spread over a range of map coordinates.

If you finish the mission without achieving either objective your commander will not be pleased, no matter how many other targets you hit. Flying around blasting the closest enemy does NOT guarantee promotions and decorations. On the other hand, targets hit in addition to the assigned objectives definitely help toward decorations and faster promotion.

Your commander will rate your performance based on time elapsed. If you are flying over 20 minutes, he will reduce the credit given for your achievements. If you accomplish both primary and secondary missions, he will automatically insist the mission is over when you return to base.

RANKS: Successful completion of your assigned missions improves your record. A good record leads to promotions. Even on the battlefield promotions take time. Don't expect a promotion after every mission.

You start with the rank of *Sergeant* — just like real helicopter pilots entering flight training. When you successfully complete a mission (usually flight training) you'll be promoted to *Warrant Officer (WO1)*. After that, success leads to *2nd Lieutenant*, *1st Lieutenant*, *Captain*, *Major*, *Lieutenant Colonel* and finally *Colonel*. Although higher ranks exist in the U.S. Army, the highest conceivable rank where an officer could still perform combat flying is *Colonel*.

Each reprimand you "earn" goes into your record and makes promotion more difficult. Reprimands occur when you use "Sick Call" to evade a mission, or when you achieve no assigned objectives. On the other hand, each heroism decoration (the *Army Commendation Medal*, *Bronze or Silver Star*, *Distinguished Service Cross*, or *Medal of Honor*) makes promotion easier.

DECORATIONS: If you do exceptionally well on a mission, you may be awarded a medal for heroism and bravery above and beyond the call of duty. Unlike rank, these decorations are based purely on your performance during a single mission. Your rank and prior record have no effect on your chance of getting a decoration (just like the real army).

The decorations for heroism and valor are (from least difficult to achieve upwards): *Army Commendation Medal*, *Bronze Star*, *Silver Star*, *Distinguished Service Cross*, and the *Congressional Medal of Honor* (America's highest military award).

In addition to decorations for heroism, additional medals and ribbons are awarded for regions of service, wounds, etc. The *National Defense Service Medal* is traditionally given for successfully completing training. The *Purple Heart* is awarded for wounds in combat. *Campaign Ribbons* for a particular region are awarded for completing a tour of duty (multiple successful missions) in that region. After a campaign ribbon, additional tours give you the *Air Medal*, which recognizes exceptional flying time.

WORLD'S GREATEST GUNSHIP PILOT: The ultimate Apache pilot is a *Colonel* with ribbons and air medals for every region. In addition, he holds the *Congressional Medal of Honor* along with a one or more lesser decorations for heroism and gallantry. Can you meet this challenge once? How many such *Colonels* can you have on your pilot roster?

PART II
APACHE PILOT'S MANUAL

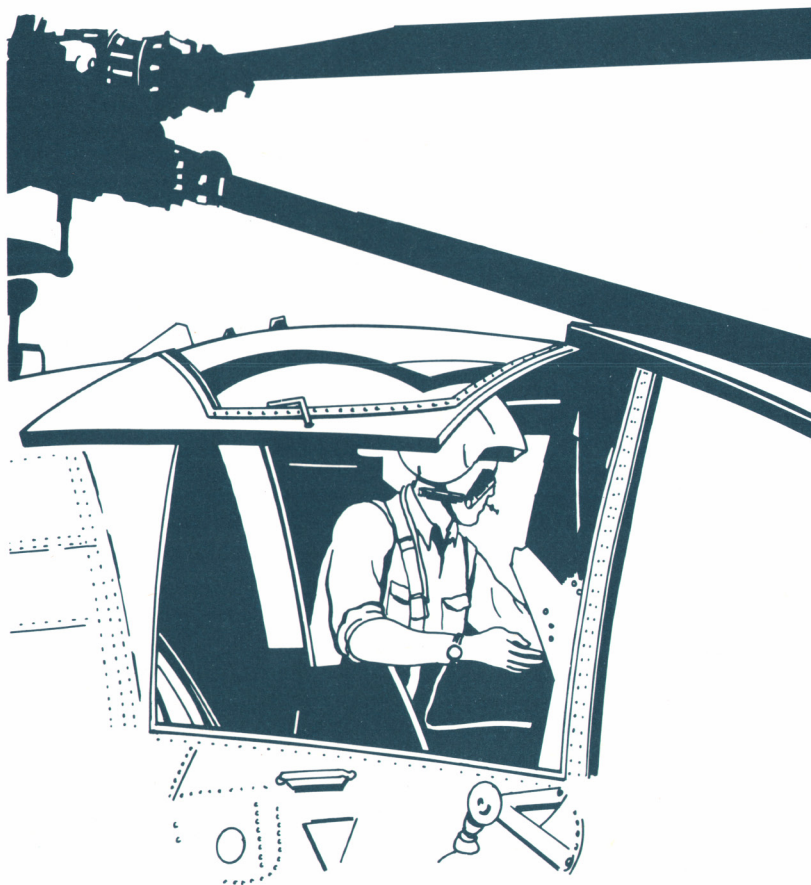

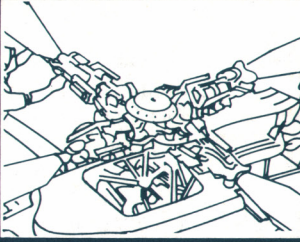

AERODYNAMICS and the AH-64A Apache

HELICOPTER AERODYNAMICS

This discussion of lift and flight is not intended to be rigorous or precise in a scientific sense. Its purpose is to provide a rudimentary understanding of the physics involved in helicopter flight. For a more detailed and accurate discussion of flight and lift, consult a textbook.

LIFT: Helicopters fly because the individual blades of the rotor are airfoils – objects that produce lift (force upwards) as they pass through the air. On normal planes the wings are airfoils. Helicopters rotate their “wings” (the rotor blades) to generate lift.

Lift is caused by the flow of the air OVER the blades, NOT the downdash of air from the rotor. The air flowing over the blade travels a shorter distance on the underside and a longer distance over the top. Bernoulli's Principle states that there is less pressure on the upper side of the blade, more pressure on the lower side. The result is a force upwards from the high pressure to the low pressure region.

LIFT from ROTOR BLADES

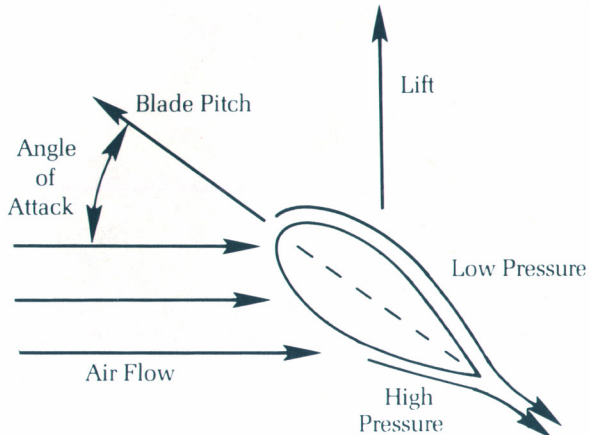

The AH-64A Apache was designed and built by Hughes Helicopter Inc., a subsidiary of McDonnell Douglas Aircraft. Phase I development in competition against Bell Helicopter began in 1972. After a "fly-off" Hughes was awarded the Phase II full-scale contract in 1976. Final prototypes were approved and manufacturing began in 1982. The first of over one thousand AH-64's rolled off the production line on September 30, 1983. It will serve in most major U.S. Army units, as well as selected Army Reserve and National Guard units. Its primary function is close ground support, especially against enemy front-line armored vehicles and anti-aircraft weapons. The craft is armored to withstand hits from 23mm cannon. Cost per machine is based on a price quoted to West Germany in spring of 1986.

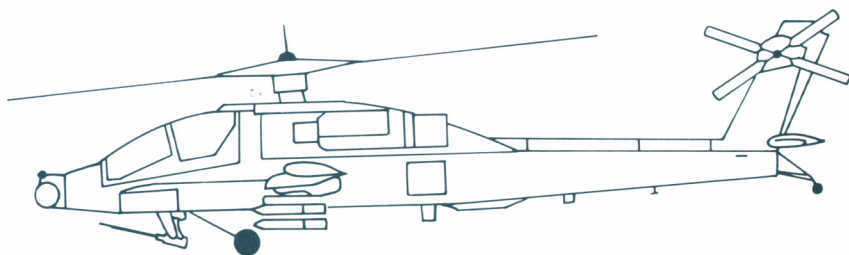
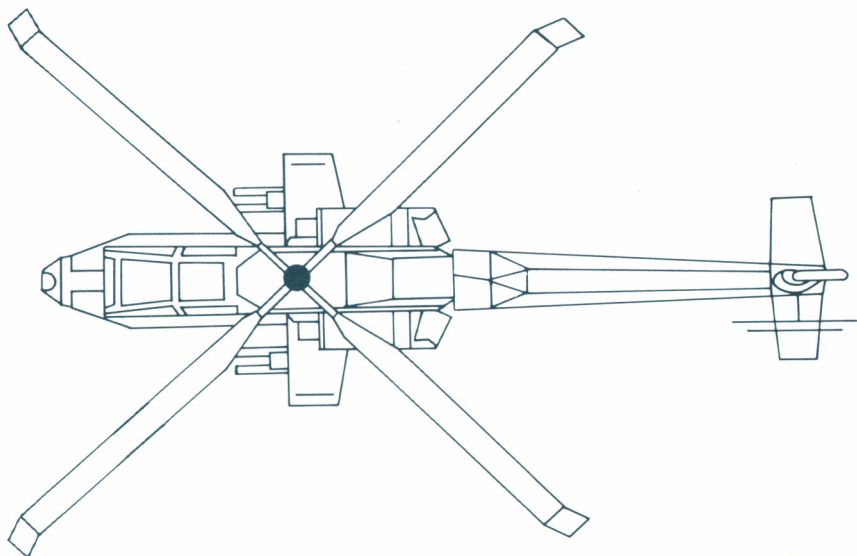

AH-64A APACHE SPECIFICATIONS

Overall Length: **58'2"**
Overall Width: **48'0"**
Overall Height: **15'3"**
Weight Empty: **10,268 pounds**

Engines: **two T700-GE-701 turboshaft jets**
Nominal Engine SHP: **1,649 per engine**
Maximum Engine SHP: **1,896.4** (running on one engine)
Rotor Speed: **280 RPM**
Fuel Capacity: **376 gallons**

Maximum Horizontal Airspeed: **162 knots** (184 mph)
VDL "never-exceed" Maximum Airspeed: **197 knots** (224 mph)
Rated Maximum Climb: **2,880 feet per minute**
Service Ceiling: **20,500 feet**
Avionics: **VHF, UHF, IFF, PNVS, TADS, DASE, Doppler Nav.**

Maximum AGM-114A Hellfires: **16 missiles**
Maximum 2.75" FFAR Rockets: **four 19-rocket pods (76 total)**
Maximum 30mm Rounds: **1200 rounds**
Maximum AIM-9L Sidewinders: **6 missiles**
Maximum FIM-92A Stingers: **6 missiles**

Production Cost in 1986 dollars: **\$7.3 Million each**
Amortized R&D Cost in 1986 dollars: **\$1.1 Million each**

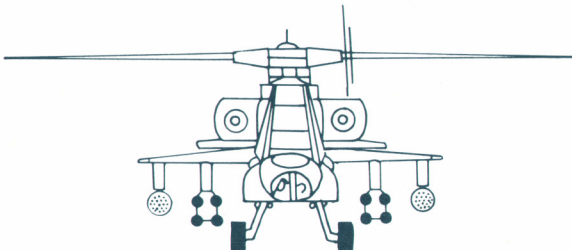

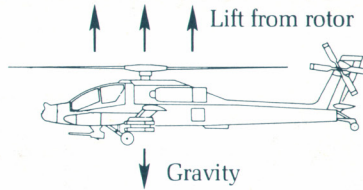
HOVERING

The amount of lift a moving blade generates depends on its angle of attack. This is the angle between the relative wind in the blade system and the blade's pitch. Pulling up (increasing) the collective increases blade pitch (the angle of attack), which increases the pressure differential, and thus gives more lift. In GUNSHIP an automatic delimitter exists that prevents you from increasing the pitch too far. However, in many helicopters you can raise the collective too high, causing the blades to "stall".

In addition to the lift created by blade pitch, helicopters also gain lift from forward motion. This lift is called "translational lift." In forward flight the rotor system as a whole acts like a fixed wing. The effect is increased lift, and therefore increased performance. On the AH-64A this increase is most notable in the 30-90 knot speed range, and includes some small extra lift generated by the weapons wings on the fuselage.

A helicopter hovering or moving very slowly at extremely low altitude creates a "ground cushion" of air beneath the rotor. This improves lift slightly. For the AH-64A Apache the ground cushion effect is strongest at roughly 12 feet off the ground. When you take off into a low-altitude hover, you are rising onto the ground cushion. However, at speeds beyond a few knots the helicopter out-distances the ground cushion effect. Pilots often refer to this as "sliding off the cushion."

CONTROLLING FLIGHT: When hovering, the lifting force of a helicopter rotor is directed straight upwards (counteracting the downward force of gravity). To move forward, you tilt the rotor so that the lifting force is now diagonally upwards – a combination of vertical and horizontal forces. The horizontal component of the force produces forward motion. Of course, the vertical component is now somewhat less, so you'd expect the helicopter to descend. This is exactly what happens – until the craft gains enough speed for translational lift to make up the difference.

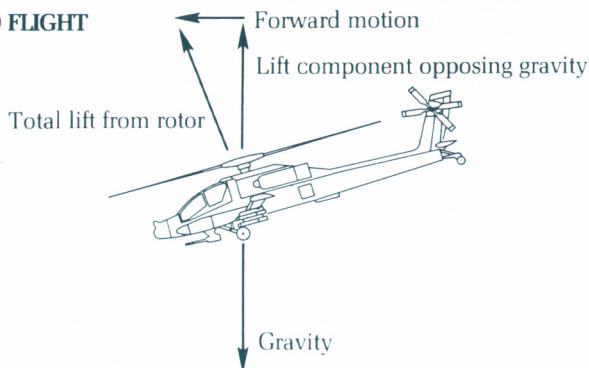
FORWARD FLIGHT

Similarly, to turn left or right, or to fly backwards, the pilot tilts the rotor in the appropriate direction. In the case of left or right turns, at very low speeds tilting the rotor causes the helicopter to sideslip ("skid") without turning. At higher speeds the entire craft turns left or right, like the banking turn of an airplane.

Once a helicopter picks up speed, the flow of air into the rotor system has an effect on lift. The blade moving backwards toward the rear of the craft (the "retreating" blade) is moving with the wind, and therefore is generating less lift than the blade moving forwards ("advancing") into the wind. To compensate, the rotor blades automatically change their pitch as they go around, maintaining an equal lifting force.

VDL (Velocity Design Limit): As a helicopter moves faster and faster, the retreating blade needs more and more pitch to generate its share of the lift. Eventually the amount of pitch required becomes too great and the blades begin to stall (cause air turbulence instead of lift) as they retreat. In short, helicopters have a maximum forward speed — beyond that speed the retreating blade ceases to be an airfoil and the helicopter loses lift. As lift decreases, so does the force creating forward motion.

The theoretical maximum speed of a helicopter is normally achieved in a sloping dive. In forward flight helicopters typically lack the power to get beyond 75-80% of their VDL. The maximum horizontal speed possible for the AH-64A is 162 knots. Officially the "never-exceed" VDL is 197 knots.

ANTI-TORQUE CONTROL: Newton's Third Law of Motion states, "To every action there is an equal and opposite reaction." In helicopters, as the rotor turns in one direction, the fuselage housing the engine(s) and transmission wants to rotate in the other direction. The tail ("anti-torque") rotor exists to counteract this tendency. It produces just enough horizontal force to prevent unwanted fuselage rotation.

On the AH-64A the blades rotate counterclockwise. The tail rotor produces force counteracting the clockwise torque on the fuselage. In a hover, or at very low speeds, a pilot can safely vary the pitch of the anti-torque tail rotor. The foot pedals (often called "rudders") are used to change the tail rotor pitch, thus changing its thrust. Reducing the pitch and thrust (pressing the right pedal) causes the fuselage to rotate clockwise (the nose swings to the right), while adding pitch (pressing the left pedal) causes the fuselage to rotate counterclockwise. On GUNSHIP the *rotate right* and *rotate left* simulate these foot pedals.

FLYING TECHNIQUES AND ADVANCED MANEUVERS

FANCY TURNS: A high speed banking turn is easy. However, in such turns your lift decreases, causing you to lose altitude. If you don't want to lose altitude, pull your nose up slightly in a turn, then drop it back down to normal as you come out of the turn. With practice you can make a fast, banking turn without changing altitude or fooling with the collective.

Very tight turns require that you stop in midair, spin, and then accelerate away in the new direction. To do this move the collective down fast, pull back hard on the stick until you're level, hit the tail rotor to rotate right or left, then raise the

collective back to normal and pitch down your nose. With practice you can even skid sideways while the tail rotor is turning your craft (a helpful maneuver if you're trying to avoid an enemy helicopter or missile).

AUTOROTATION: Helicopter crewmen don't have parachutes. You can't bail out. Fortunately, the AH-64A is an exceptionally crashworthy machine with a good probability of crew survival. However, the loss of both engines does not mean you must crash. Helicopters have an equivalent of an airplane's "dead stick" (or "flameout") landing. This unpowered descent is called "autorotation."

AUTOROTATION

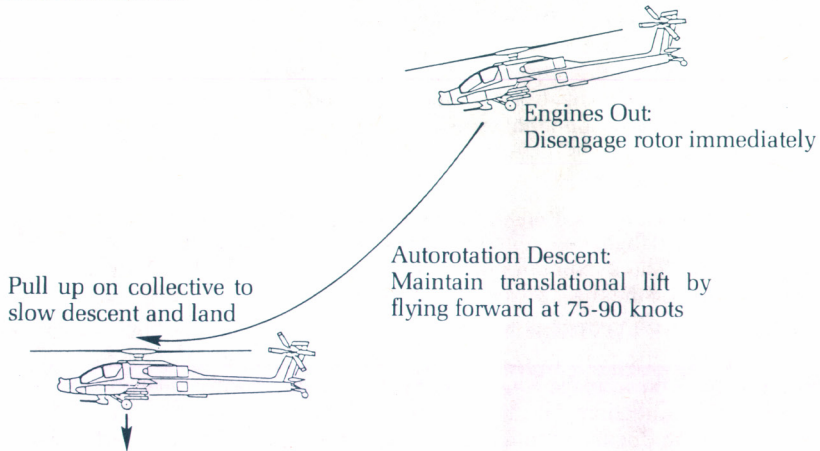

To begin an autorotation, disengage the rotors from the engine. Usually the pilot must bottom the collective, but in GUNSHIP the collective is automatically bottomed when the rotors are disengaged. In an emergency where you have both engines out, do this *immediately*. If you don't, the rotor will slow to a stop (it's still engaged to the now-dead engines). If the rotor stops turning before you're safely down, you're a dead duck.

Now pitch the nose so you're travelling at about 75 to 90 knots (for maximum translational lift). The rotor is spinning freely because the airflow keeps the blades turning. The descent becomes quite fast and a little frightening to the inexperienced. As you get close to the ground, raise the nose and pull up on the collective. The blades will "bite" into the air, giving you lift and slowing the descent. Unfortunately, as the blades bite, air resistance slows them down and the rotor RPM drops.

You must time the "up collective" so that the helicopter lands gently before the rotor slows too much. If you raise the collective too soon, the rotor will get below airfoil speed while you're still above the ground. Without the lift from the blades, you'll fall like a rock! If you raise the collective too late, you won't slow your descent fast enough and the machine will crash land.

UNSAFE FLYING: It takes time to disengage the rotors, get the craft under control, and then "up collective" to land. As a result, there are speed-altitude situations

where an engine failure results in the craft hitting the ground before you can perform an autorotation. Hovering at altitudes above 25 feet up to about 500 feet is unsafe, as is high-speed flying under an altitude of 20-30 feet.

HEIGHT-VELOCITY DIAGRAM

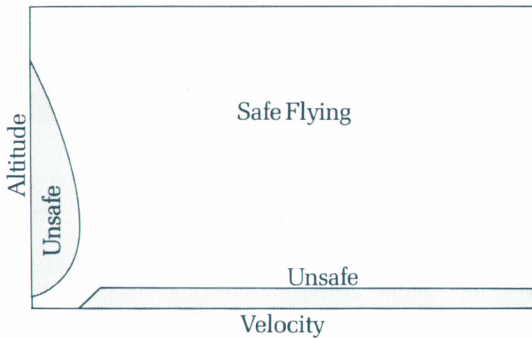

“Unsafe” as described above applies to civilian and non-combat flying. In combat situations unsafe flying may be “safer” than taking a missile or cannon hit! In the AH-64A normally unsafe flight practices aren’t quite so dangerous. If one engine dies, the other can keep the helicopter aloft. In single-engine flight, the surviving engine can run at 110% power continuously (this power increase is automatic in GUNSHIP), or at 115% for six minutes. The engines and rotor can keep turning for at least 30 minutes even if the lubrication system fails. In comparison, oil lubrication system failures and fires are a major weak point of the Russian-built Mi-24 HIND helicopter. Overall, the Apache is a forgiving machine designed for daredevil pilots, unlike the less forgiving single-engine UH-1 and AH-1 helicopters of the Vietnam war.

OPEN FIELD LANDINGS: The nice thing about helicopters is their ability to land without a paved airstrip. However, helicopters cannot land on sloping ground. Any slope greater than 5 degrees causes so much rotor tilt that the helicopter flies, skids or turns away from the slope, making a landing impossible. Never try to land on a hillside — you’ll crash.

WIND & WEATHER: Ideally, all takeoffs and landings should be into the wind. However, a helicopter can take off and land in crosswinds or tailwinds. As the helicopter rises to a hover (in takeoff), or slows down to hover (in a landing), the cyclic joystick should be moved slightly toward the wind, producing just enough skid to counteract the wind velocity. This maintains the hover against the wind.

When flying in windy conditions, the same considerations apply as flying a normal airplane. Namely, the wind will increase your speed, slow you down, and/or push you sideways, depending on your flight path in relation to the wind direction. This is most noticeable on long-distance flights.

Temperature also affects helicopter flight. As air gets warmer, it expands and becomes thinner, providing less lift. If the air gets too cold, icing on the rotor becomes a problem. Similarly, in humid conditions the air is composed increasingly of water, reducing lift. Finally, as altitude above sea level increases, air gets thinner, reducing lift. For the AH-64A, ideal flying conditions are 76 degrees Fahrenheit (24.4 degrees centigrade) on a dry day at sea level.

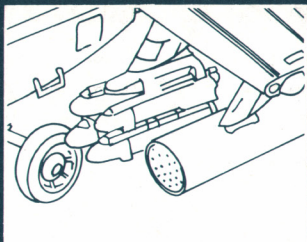

WEAPONS & TACTICS of the AH-64A Apache

AH-64A WEAPONRY

THE TARGET ACQUISITION & DESIGNATION SYSTEM (TADS): The AH-64A uses a novel and very effective gunsight system called TADS. Both the pilot and gunner wear an IHADSS helmet which includes a monacle in front of the right eye. The cockpit and helmet have IR diode sensors that track the helmet's position in three dimensions. When the crewman turns his head and looks through the monacle at a target, the TADS computers "know" what direction he is looking. The nose TV camera, laser, FLIR optics (forward-looking infra red for vision in low visibility) and Chain Gun all point in the direction he looks.

In GUNSHIP the TADS gunsight is a small box that appears in the upper cockpit glass. When you lock it onto a target, a zoom TV camera view appears on the CRT below, including the range in kilometers and magnification of the camera. Once TADS is locked onto a target, it tracks while you maneuver and fly the helicopter. As long as the target remains in your field of view TADS will track it.

TADS includes a laser rangefinder and ballistic computer that automatically aim the 30mm Chain Gun cannon at the target. In addition, when the AGM-114A Hellfire is armed for firing, the laser acts as a designator that "calls out" the target for the missile.

The 2.75" FFAR rockets and the AIM-9L Sidewinder operate independently of the TADS. The rockets are unguided ("dumb" weapons) that fly straight ahead. The AIM-9L Sidewinder has its own built-in IR seeker. If you aim it toward an enemy aircraft or helicopter and then fire, it should find its own way to the target.

Note that TADS is a "line of sight" system built into the nose of the helicopter. As a result, the greater your altitude, the further TADS can see. Conversely, as you descend, TADS range is reduced. It's not uncommon to lose targets in a power dive. If another target is available, TADS switches to that. Otherwise it switches off.

THE 30mm CHAIN GUN: This automatic cannon is beneath the nose on a mount that swivels and elevates under control of the TADS ballistic computer. It is NOT aimed manually. The computer aims the gun at whatever target is designated by the wearer of the IHADSS helmet, and then computes deflection using the laser rangefinder.

The cannon fires 625 rounds per minute. Traditional machineguns and automatic cannons use the recoil of one shot to load the next. If a shot misfires or the belt jams there is no more recoil and the gun is useless until a mechanic disassembles the weapon and clears it. Since 1916 jamming in aircraft machineguns and cannons has been a serious problem. The "Chain Gun" does not use this principle. Instead an electric motor pulls the ammo belt through the gun (hence the term "chain gun").

Even if a shell misfires or is a dud the motor continues pulling the ammo belt. This greatly reduces the probability of a disabling jam.

The 30mm Chain Gun cannon normally fires HEDP (high explosive dual purpose) rounds that are effective against both unarmored and armored targets. The rounds are not powerful enough to pierce the thick frontal armor of a main battle tank. They are effective against the thinner top and rear armor of tanks. The cannon can use European 30mm DEFA ammunition if American-made HEDP is unavailable.

The main disadvantage of the Chain Gun is its enormous recoil, despite the relatively low muzzle velocity. No other helicopter carries such a heavy weapon. As a result, although the cannon may be aimed "on target," after a few rounds it could be off target again. This problem is especially serious when the cannon is firing left or right, and minimized if the cannon is firing ahead.

The cannon's maximum range is approximately 1.5 kilometers. However, its low muzzle velocity and recoil problems suggest that effective range for reasonably accurate shooting (i.e., at least a 50% change of hitting a target dead ahead) is perhaps half that, or about 0.7 kilometers.

On the "plus" side, the 30mm cannon is an enormously valuable weapon against enemy helicopters and slow-flying aircraft. The IHADSS and TADS system allows it to "track" and engage enemy targets to either side and below the helicopter — the pilot need not point his helicopter at the target to fire. Helicopters with manually controlled turrets (such as the Mi-24 HIND-D) or fixed weapons (such as the Mi-24 HIND-E) lack this advantage. However the slow rate of fire makes the cannon ineffective against fast jets, which can literally fly between the shells.

AGM-114A HELLFIRE ANTI-TANK MISSILES: The Hellfire is a semi-active laser-homing missile with a HEAT armor-piercing warhead.

The missile's guidance system homes on the scattering frequency of a laser hitting a target. In other words, the missile does not "see" the laser beam. Instead, when the laser beam hits a target and breaks up the missile "sees" the beam breakup. If the laser beam is switched from one target to another, the missile will "see" the target spot change, and fly toward the new target. This allows "ripple fire" tactics where the Apache launches two or more missiles, one behind another. When the first missile hits, the laser is switched to another target, and the second missile (already in flight) homes on the new target.

Laser designators are not as effective in rain, snow, fog, or smoke. The beam breakup "spot" cannot be "seen" as easily. A favorite defense against laser designated weapons is a quick smoke screen. Many tanks now carry multiple smoke projectors for just this purpose. In bad weather conditions aircraft are often grounded, making the laser designation problem moot.

The disadvantage of the laser system is that the helicopter must remain exposed, laser shining, to guide the missile to target. Fortunately, the Hellfire can be guided by standard U.S. Army laser designators, carried on various scout helicopters and by ground troops. They can designate a target for a missile launched by the Apache. This means the Apache could fire from a hidden position, just like an artillery piece. Of course, such tactics require excellent radio communication and superb timing. The more common "scenario", portrayed in GUNSHIP, is the Apache designating its own targets "on the fly".

The Hellfire's warhead is a 177.8mm diameter HEAT design: High Explosive Anti-Tank. This burns through virtually any steel armor as well as most modern composites and spaced armor. The armor-penetrating ability of HEAT is proportional to the warhead diameter. The Hellfire has a 177.8mm diameter warhead; America's previous top-quality anti-tank missile (the TOW), still greatly respected, has a 152mm warhead.

Unfortunately, this warhead design is ineffective against "soft" targets such as groups of men, building complexes, or AA gun sites. In the simulation, this means a Hellfire cannot destroy a Headquarters, Depot, Helibase, or a AA gun site (such as the 23mm ZU-23 or the 57mm S-60). However, it is extremely effective against vehicles. It can also penetrate and destroy bunkers.

The Hellfire is an extremely long-ranged missile. Most ATGMs (anti-tank guided missiles) have a range of three kilometers. The Hellfire can fly up to six! Range does not affect accuracy: as long as the Hellfire can find the spot designated by laser, it will hit it.

2.75" FOLDING FIN AERIAL ROCKETS (FFAR): The 2.75" FFAR rockets, in pods of varying sizes and weights, are a venerable weapon dating back to the 1950's. The rockets themselves are completely unguided, with a reputation for erratic flight, and sometimes not firing at all! Maximum range is about 1.8 kilometers, but a wise gunner waits until he's much closer before firing. The 7- and 19-rocket pods for the AH-64 are a new lightweight design that minimizes the "dead weight" of the launcher pod.

The standard rocket warhead is a typical "HE" high explosive/fragmentation type that is quite effective against ground troops, AA gun sites, and installations. Men on the receiving end of a full pod volley can feel the ground shake and buck beneath them, like an earthquake, while deadly metal fragments fill the air. The shock effect alone can daze men for minutes. Near-misses and shock effect is not enough to disable an armored vehicle or bunker, although a lucky explosion could immobilize a vehicle.

Despite their drawbacks, the FFAR rockets are a good compliment to the Hellfire missiles. They are most effective against targets the Hellfire can't really hurt. They can be fired at a longer range than the cannon. Even if the rockets miss they often "suppress" soft targets. The helicopter can then close for the kill using cannon fire. FFAR rockets are also extremely cheap to build and a common item of resupply throughout the Western world.

It is relatively easy to build FFAR rockets with special warheads, such as White Phosphorous (WP), which burns intensely and gives off a cloud of smoke, or even various chemicals such as tear gas. Although such weapons are rare today, there is considerable fear that the Warsaw Pact plans heavy use of chemical warfare if involved in a European conflict.

AIM-9L SIDEWINDER AIR-TO-AIR MISSILES: The AIM-9L is an all-aspect infra red homing air-to-air missile. It was combat-proven in the Falkland Islands, where most of the "kills" accomplished by British Harriers against Argentine jets were with "Niner Limas". The British pilots were quite satisfied with the performance of this weapon.

The Sidewinder was originally created in the early 1950's by a small team on a shoestring budget. The early models proved difficult to use in the Vietnam air

war. The Sidewinder homes on heat: early models homed on the heat of a jet exhaust. They would also home on the sun, common distress flares, or even hot ground or rocks during a summer day! In the 1970's the seeker was dramatically redesigned to be much more sensitive (through cryogenic cooling) and less vulnerable to spurious heat sources (through the use of filters). The missile's speed, maneuverability and range (now almost 18 kilometers) were all improved. The warhead was redesigned to explode into destructive spinning rods, and gained a new ultra-high-tech proximity fuse.

The "L" model combines all of these improvements and is being manufactured in gigantic quantities by various American and European firms. Many older versions are being rebuilt to "L" standards. The "L" model can home on surfaces heated by air deflected across metal (such as the upper surfaces of aircraft wings or rotor blades). This means the missile does not need to "fly up the tailpipe" of a jet to hit the target, but can instead attack from a variety of angles. This dramatic new capability is termed "all aspect" attack. The AIM-9L is probably the best missile for air-to-air dogfighting in the world today.

The missile is only effective against aircraft targets, especially unarmored jets. It is reasonably effective against helicopters, especially since warhead rods can break rotor blades (an immediately fatal event for any helicopter). Sidewinders are generally unable to home on ground targets, and even if they could, would only damage small, soft targets.

Currently no U.S. Army AH-64A Apaches carry Sidewinders. According to "the book" Apaches are intended for ground attacks, not air-to-air combat. Reluctantly the Army is recognizing the threat of opposing helicopters. However, due to a bad case of interservice myopia, it is considering arming the AH-64A with the designed-for-the-Army FIM-92A Stinger, a much smaller and less destructive missile intended for use by infantrymen.

Fortunately American servicemen in combat conditions often ignore "the book" and acquire whatever weapon does the job best. In this case, the plentiful and effective AIM-9L Sidewinder, despite being an Air Force weapon, is likely to find its way into the arsenals of Apache attack helicopter squadrons. Wiring up Apache weapons wings for Sidewinders is easily done "in the field." For all of these reasons, the AH-64A portrayed in this simulation is armed with Sidewinders, not Stingers.

ATTACK TACTICS

THE APPROACH: The vast majority of AH-64 flights are ground-attack missions. You are to knock out hard or soft targets in a certain area — often an area protected by SAMs and AA guns.

Your first task is to make sure you know where on the sector map to find the primary and secondary targets! Setting your INS on the sector map to the primary target and flying full speed at a few hundred feet of altitude toward the target may work on training missions or in Southeast Asia, but it's pure suicide against well-equipped enemies in the Middle East or Western Europe.

The standard U.S. Army technique is to fly in quick dashes ("bounds"). Fly from the base of one hill to another. Before making a dash, hover and pop up briefly to 100-200'. Scan around and use TADS to identify potential enemies. Drop low

again and examine your sector map. It shows all enemies you sighted, or who sighted you. Pick your next dash, set the INS, rotate to face that direction, then pitch down and zoom forward. Stay as low as possible in a dash. When selecting routes, use hills to screen yourself from enemy fire.

FIRING: Use the right weapon for the job. At longer ranges (over 0.7 kilometers) use the Hellfires against vehicles and bunkers, the FFARs against infantry, AA gun sites, and buildings, and the Sidewinder against enemy helicopters. If you are brave enough to get in close your best all-around weapon is the 30mm cannon. Beyond 700 meters or when making side shots the cannon consumes large amounts of ammunition for each hit (due to its poor accuracy at longer ranges).

“POP UP” ATTACKS: The “pop up” technique is simple. Hover behind a hill that screens you from suspected enemy positions. Climb up over the hill until you’re just above the crest. Scan around and watch your threat display. If you recognize an important target immediately, open fire. If not, drop down behind the hill again and examine your sector map. You can now consider your situation and decide if you want to pop up again and attack those targets, or whether you should bound on, avoiding them. If you decide to attack, pop up again just long enough to knock out your selected target, then drop down again.

FLAK & SAM BUSTING: Because a helicopter can sneak up on targets, taking full advantage of terrain cover, it is much better suited to attacking AAA and SAM batteries than traditional fixed-wing aircraft. Army/Air Force cooperation tactics plan on Apaches attacking anti-aircraft weapons while A-10 “Thunderbolt II” jets bombard ground targets.

The key to eliminating enemy SAMs and ZSU AA tanks is engaging them quickly. Enemy anti-aircraft defenses have a 5 to 20 second reaction time, depending on the quality of the equipment and skill of the crew. You must destroy them during this time. Enemy SAMs give you a little extra time and warning because you can see the missile coming on the threat display. Enemy AA guns are tougher because you can’t see the shells coming (they fly too fast), and because guns can use optical gunsights you can’t jam or decoy! Unfortunately, some of the newest Soviet-built SAMs also have optical guidance systems for missiles. However, night gives you an advantage against optical systems because Soviet-made night-vision aids are much inferior to your high-tech FLIR viewers.

TANK HUNTING: The Apache was designed to kill tanks. It’s just a matter of loading up with Hellfires and heading out to the happy hunting grounds. At a kilometer or two it’s like shooting fish in a barrel. If you prefer, you can come closer and cut them apart with the 30mm cannon. The U.S. Army expects a 14-1 kill ratio (i.e., when you kill your 14th tank, the helicopter has paid for itself as a cost-effective weapon). In your eagerness to create scrap metal, make sure you don’t blast friendly tanks by accident!

Russian tanks don’t carry an AA weapon larger than a 14.5mm machinegun. The BMP mechanized infantry vehicles are nastier because most carry an SA-7, SA-7B or SA-14 “Grail” missile inside. However, these are lightweight IR homing missiles. The SA-7 and SA-7B are easily confused by jamming or decoys. Warheads are small: even if one hits you, you’ll probably survive it. The brand new SA-14s are believed to be more potent and less easy to fool. The biggest problem in tank hunting is that Russian AA tanks and SAM carriers have a nasty habit of traveling with the tanks and BMP’s. Whenever you see a large concentra-

tion of T-74's or BMP's, keep an eye out for a ZSU-23-4 (or ZSU-30-2) AA tank, or the SAM carriers, such as the SA-9 and SA-13 IR missile carriers, or the more formidable SA-8 and SA-11 radar missile carriers.

INFANTRY TARGETS: Infantrymen in open ground are difficult to see with the naked eye. TADS has similar problems — on the CRT an infantry position doesn't look like much. Infantry may carry machineguns and other light weapons, or sometimes the SA-7, SA-7B or SA-14 "Grail" IR homing missiles. You can attack infantry with FFARs or the 30mm cannon. If you charge in fast and low you might get them before they're ready to get you!

Infantry are tricky because it's hard to tell the good guys from the bad guys. Again, check your map to avoid making costly and painful mistakes. On the plus side, bunkers are easy. They don't have Grails and can be destroyed using the Hellfire. However, most bunkers have thick roofs nearly impervious to cannon fire.

STRUCTURES: Rear area structures, such as headquarters, heli-base, or supply depot, pose problems similar to infantry. Although bigger and easier to see, most have "Grail" IR homing missiles sited for air defense. In addition, extra AA gun sites are often emplaced in the area. Try to locate these defenses as well as the base itself before you charge in. The AA gun sites are a nuisance because Hellfires are ineffective against them.

When attacking structures, be sure you have the right one. It's embarrassing to wipe out your own heli-base. In guerilla warfare environments such as Central America or Southeast Asia, your TADS will lock onto local farm buildings as well as military bases. Unless you actually see enemies firing from the building, don't destroy it. Remember, you're trying to win the people's hearts and minds.

DEFENSIVE TACTICS

The most common problem you'll have is surviving enemy ground fire. This includes enemy anti-aircraft artillery (AAA or "flak") and surface-to-air missiles (SAMs). From a pilot's point of view, some of these are radar-guided threats, some are IR threats, and some are optically guided (and therefore don't warn you at all!).

WHEN THEY SEE YOU: Only the higher quality AAA and SAMs use radar-guided systems. Among AAA weapons this includes the ZSU-30-2 and ZSU-23-4 vehicles, plus more advanced versions of the S-60 57mm gun. Among SAMs it includes all except the hand-carried SA-7, -7B, -14 series and the early SA-9 Gaskin.

These weapons have "search" radars which can "see" you at long ranges in day or night. If you see a distant red dot on the threat display, it's probably a search radar looking at you. Most search radar "sweeps," causing the radar warning light to flash on and off. Since the purpose of search radar is to detect your presence, jammers and decoys are counter-productive, as both announce your presence!

All other enemies lack long-range search radar. Many use eyesight and binoculars to search. They can't "see" you until you are much closer. At night their eyesight is especially limited. However, if you open fire, you'll certainly attract their attention, causing many additional enemies to "notice" you.

TRACKING

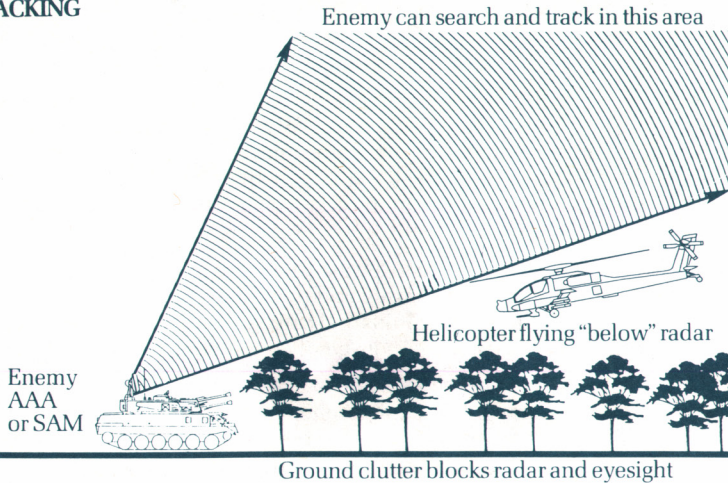

Radar, like normal eyesight, is blocked by objects on the ground. As a result, ground-based radar has a "dead zone" it cannot see. Above this dead zone the radar "eyes" will find you. The dead zone becomes smaller and lower as you approach the radar.

HOW THEY TRACK YOU: If an enemy search is successful, they switch to a "tracking" mode. If using radar, they constantly illuminate you with a beam. This sets off your radar warning and causes the light to shine solidly "on." As with searching, tracking radar as well as eyesight has a "dead zone" near the ground that varies with distance. Therefore, if you're being tracked by radar, or suspect you're being tracked visually, fly lower and away from the enemy to break the track. Ducking behind a hill will also break a track — enemy eyes and radars cannot look through hills!

Another way to break the radar tracking is to use your radar jammer or drop a load of chaff. If jamming is successful the radar warning light turns off. If it fails, the warning light remains on — you should definitely use chaff or try evasive flying. Using chaff decoys the enemy radar into locking on the chaff — as long as the chaff cloud persists. The chaff light on the cockpit turns off when the chaff cloud disperses.

A few advanced enemy weapons have visual backups for tracking systems. These may be TV cameras, lasers, or simply optics. Therefore, even with the best jamming or decoys, they could still open fire. The only way to defeat these is evasive flying. All AA guns and probably the new SA-11 fall into this category.

SURVIVING AA GUNFIRE: After tracking you for sufficient time, enemy AA guns will open fire, and continue firing until they knock you down. You must either break the track or destroy the weapon. There are no other options. If the gunfire is radar controlled (your radar warning light will be on) you could temporarily break the track with radar jamming or chaff. However, all guns have optical backup systems, and some only have optics. The best way to survive gunfire is skillful evasive flying.

SURVIVING SAMs: After a SAM battery has tracked you for a few seconds, they launch a missile. Missiles come in three flavors: IR-guided, radar-guided, and visually-guided. When the enemy fires a missile, you'll see a white dot moving toward you on the threat display. Bear in mind that IR-guided missiles have their "seeker" on board the missile, while radar and visual guidance missiles are controlled from the launcher vehicle.

IR-guided missiles are the most frequent threat. Your IR warning light will turn on when they approach. If you turn on the jammer, and it succeeds in jamming the missile, the missile's "brain" becomes confused and it flies mindlessly straight ahead. You should change course to avoid colliding with it! If the IR jammer fails, try dropping a flare decoy instead. The missile will aim for the decoy instead of you. It's important to wait a bit before launching decoys, since they burn out after a while and the missile will home on you again. "Poor" IR guidance systems are vulnerable to either decoys or jammers. "Fair" systems are vulnerable to decoys, and sometimes to jammers. "Good" systems are vulnerable to either decoys or jammers, but almost never both, and sometimes are vulnerable to neither! Finally, very modern and sophisticated IR missiles may have a visual or laser backup system. Don't assume that defeating the IR guidance will always confuse a missile.

Radar-guided missiles are primarily designed for use against jet aircraft, but could threaten you too. A radar beam shining on your craft guides the missile at you. Using your jammer will break the beam, causing the missile to fly straight (therefore you should dodge). Using a chaff decoy will cause the missile to fly toward the chaff instead of toward you. The problem with radar-guided missiles is that they have back up systems. The SA-8 and SA-8B become IR guided missiles if their radar fails. The SA-11 has an unknown but probably visual-type backup system if the radar is jammed or decoyed. Therefore, defeating the radar is just the first step in defeating the missile.

Visually- or laser-guided missiles are the worst threat. You have no jammer or decoy defenses against these. Your only weapon is evasive flying. Putting a hill between you and the missile is the best bet. Getting low enough to become invisible to the launcher (and therefore breaking the visual or laser track) is the only other hope. Remember, successful evasive flying requires that you fly lower AND away from the enemy. If you continue flying toward the launcher, flying lower may not help.

All missiles have a universal weak point: they have a huge turning radius. If you let one get close, then dart off perpendicular to its flight path, it will be unable to turn fast enough to hit you. This tactic is fairly easy in a high-speed jet aircraft, but far more difficult to accomplish in a relatively slow helicopter trying to avoid a missile flying at 1,000 mph or faster! It takes enormous skill, split-second timing, and steady nerves to "turn inside" a missile with a helicopter.

The chart on the following page summarizes the various Soviet-built AAA and SAM systems, with a description of the search, tracking, and guidance (for missiles) systems. Read your intelligence briefings before each mission, then look up each weapon on this chart. Learn what missiles have backup guidance systems, and which ones do not.

THREAT CHARACTERISTICS

Weapon	Type	Search Technique	Main Tracking	Backup Tracking	Main Guidance	Backup Guidance
SA-7 (*) Grail	SAM	optical	optical	(none)	poor IR	(none)
SA-7B (*) Grail	SAM	optical	optical	(none)	fair IR	(none)
SA-14 (*) Grail	SAM	optical	optical	(none)	good IR	(none)
SA-9 Gaskin	SAM	optical	optical	(none)	poor IR	(none)
SA-9B Gaskin	SAM	optical	radar	optical	fair IR	(none)
SA-13 Gopher	SAM	optical	radar	visual	good IR	uncertain
SA-8 Gecko	SAM	radar	radar	optical	radar	fair IR
SA-8B Gecko	SAM	radar	radar	optical	radar	good IR
SA-11 Gadfly	SAM	radar	radar	unknown	radar	unknown
ZSU-57-2	AAA	optical	optical	(none)	n/a	n/a
ZSU-23-4	AAA	optical	radar	optical	n/a	n/a
ZSU-23-4M	AAA	radar	radar	optical	n/a	n/a
ZSU-30-2	AAA	radar	radar	unknown	n/a	n/a
S-60 57mm	AAA	varies**	varies**	(none)	n/a	n/a
ZU-23 23mm	AAA	optical	optical	(none)	n/a	n/a

*hand-held missiles carried in BMPs, carried by infantry, and used to defend headquarters, heli-bases, and depots.

**radar or optical, depending on the sophistication of the army using the weapon.

n/a = not applicable: gun shells do not need to be guided to target.

AIR-TO-AIR COMBAT

Russian-built Mi-24 HIND helicopters are your air-to-air combat problem. They are somewhat faster than your AH-64 (you'll never outrun them!), but much less maneuverable. The "E" model with four 23mm cannons is the most common threat. HINDs are unable to fire accurately sideways in a dogfight, although some do have rotating turrets able to hit stationary targets. You, however, don't suffer that restriction. Therefore, your goal is to prevent them from heading toward you. The worst possible situation is to have a HIND approaching from the rear. They can fire at you, but you can't even see them!

A typical HIND tactic is to sit behind a hill waiting for you, then charge forward, guns blazing. They also tend to circle around, trying to get on your tail.

If you have a HIND charging you, you can either nail him at long range with a Sidewinder, or evade him until you're ready to use your cannon. The best evasion technique is hiding behind a hill. Failing in that, fly off to the left or right. As he turns toward you and lines you up in his sights again, turn the other way fast. Take advantage of his slow turning rate. As he gets closer, circle around him. Keep your TADS on him throughout this process (you'll probably need to use the left or right view while circling around). When the reticle box brightens, show him what a 30mm cannon can do.

If you have a HIND on your tail, you'll take rapid and heavy damage as his cannons pound you. You've got to shake him off, fast. Break right or left hard. Pitch up to cut your speed. "Up" collective to "elevator up" or "down" the collective to "elevator down". If your speed drops below 50 knots use the tail rotor to spin you around while skidding sideways, then pitch down and bank away. HINDs are

poor dogfighters, so once you shake him, he'll probably fly past to the right or left and start circling around. Getting on his tail and teaching him a lesson should be easy.

A new model Russian helicopter with air-to-air IR homing missiles is believed to exist. Whether you call it an "F" model HIND or the Mi-28 Havoc, it's still a serious threat. Keep an eye out for missile-firing helicopters when facing first line units in Western Europe.

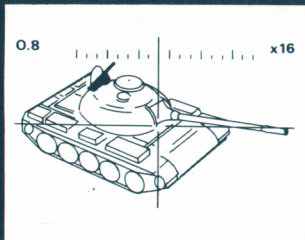

MILITARY EQUIPMENT on the Modern Battlefield

Use the illustrations in this section as a guide to answering the vehicle identification quiz when GUNSHIP begins. The notes on Soviet AA guns and SAMs are especially useful in understanding the strong and weak points of enemy weaponry.

WESTERN BLOC EQUIPMENT

M1 and M1A1 "Abrams" **Main Battle Tank - USA**

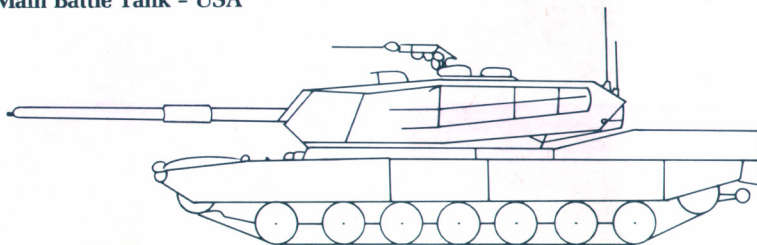

Weight: 62.9 tons
Main Weapon: 105mm Rifled or 120mm Smoothbore Cannon
Secondary Weapon: three machineguns
Armor: Heavy (Chobham)
Crew: 4
Hull Length: 7.9 meters
Hull Width: 3.7 meters
Height: 2.9 meters
Engine: 1500 hp gas turbine
Maximum Road Speed: 41.5 mph

This is the new standard tank of the U.S. Army, with the latest engine, armor, and in the A1 model, a new West German-made smoothbore gun, not to mention lots of high-tech hardware. It is considerably superior to all known Russian tanks, but suffers from having a novel engine design that needs to work more reliably. Unlike the Soviet T-74, the M1 Abrams is an entirely new design that actually works. It's a curious twist that the Soviets, generally viewed as creative and innovative tank designers, have been "one-upped" by the U.S. Army, who formerly lacked a reputation for "state-of-the-art" tank design.

M2A1 "Bradley"
Infantry Fighting Vehicle - USA

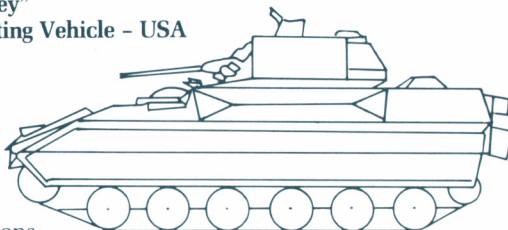

Weight: 24.8 tons
Main Weapon: 25mm Auto-Cannon
Secondary Weapon: two TOW missiles
Armor: Light (aluminum laminate)
Crew: 3 + 7 passengers
Hull Length: 6.5 meters
Hull Width: 3.2 meters
Height: 3.0 meters
Engine: 500 hp diesel
Maximum Road Speed: 41.0 mph

This is the new armored personnel carrier of the U.S. Army, designed to compete with the Russian BMP while keeping pace with speedy M1 tanks. It is heavily armed, lightly armored and crowded inside. Although superior to the M113A3, it must be cautious when engaging enemy tanks. The TOW missile is no longer an invincible tank-killer.

M113A3
Armored Personnel Carrier - USA

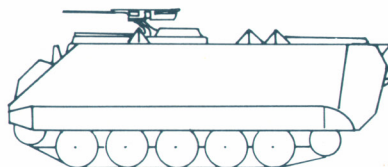

Weight: 12.5 tons
Main Weapon: one or two machineguns
Secondary Weapon: none
Armor: Light (aluminum/steel)
Crew: 2 + 11 passengers
Hull Length: 4.9 meters
Hull Width: 2.7 meters
Height: 2.5 meters
Engine: 275 hp diesel
Maximum Road Speed: 42.0 mph

This is the latest variant of the U.S. Army's venerable "battle taxi" for infantry. It can carry and protect infantry from incidental fire, and is fairly useful against poorly armed Third World troops. Against well-outfitted opponents it should stay out of the line of fire.

M163 Vulcan PIVADS
Self-Propelled AA Gun - USA

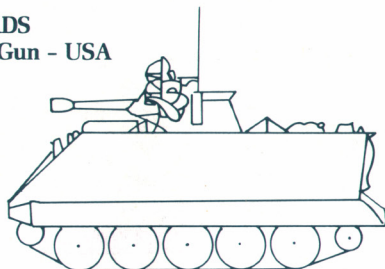

Weight: 13.5 tons
 Main Weapon: 20mm Gatling Gun
 Secondary Weapon: none
 Armor: Light (aluminum/steel)
 Crew: 4
 Hull Length: 4.9 meters
 Hull Width: 2.9 meters
 Height: 2.8 meters
 Engine: 215 hp diesel
 Maximum Road Speed: 40.5 mph

The Product Improved Vulcan Air Defense System married a six-barrel 20mm Vulcan cannon with the ubiquitous M113 chassis. The gun is aimed by a gunner, who is aided by a radar rangefinder and tracking fire-control computer. Although useful against unarmored helicopters and slow-moving planes, it is ineffective against distant or high-speed targets (such as low-flying jets).

M247 Sergeant York DIVAD
Self-Propelled AA Gun - USA

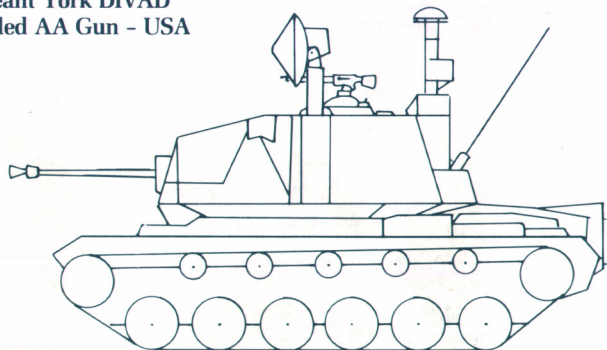

Weight: 60 tons
 Main Weapon: twin 40mm Cannon
 Secondary Weapon: one machinegun
 Armor: Light (steel)
 Crew: 3
 Hull Length: 7.1 meters
 Hull Width: 3.6 meters
 Height: 4.6 meters (including antennae)
 Engine: 750 hp diesel
 Maximum Road Speed: 29.8 mph

The Sergeant York gun was designed to provide medium range rapid-fire AA gun defenses for US troops. The U.S. Army has lacked a long-range, effective AA gun for decades. This design was cobbled together from an old M48 tank chassis, standard 40mm AA guns, and a fighter plane's radar system.

Unfortunately, the Sgt. York repeatedly failed combat trials. Only after 146 had been produced was the U.S. Congress able to close down production of this remarkably expensive boondoggle.

M48A1 Chaparral **Surface-to-Air Missile (SAM) System - USA**

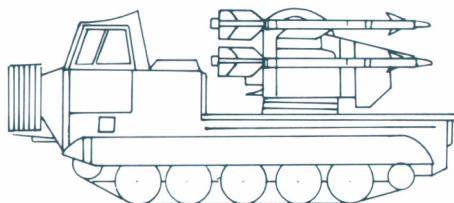

Weight: 12.7 tons
Main Weapon: four MIM-72C IR homing missiles
Secondary Weapon: none
Armor: Light (steel) for crew only
Crew: 4-5
Hull Length: 6.1 meters
Hull Width: 2.7 meters
Height: 2.7 meters (including antennae)
Engine: 202 hp diesel
Maximum Road Speed: 38.0 mph

The Chaparral combined a modified Sidewinder air-to-air missile with the U.S. Army M548 carrier. It is designed to work as a team with the Vulcan AA vehicle. The Chaparral uses its IR homing missiles at targets too fast for the Vulcan. Like the Vulcan, it has no integral search radar. Therefore it cannot engage targets until the gunner sees them.

Merkava Mk 2 **Main Battle Tank - Israel**

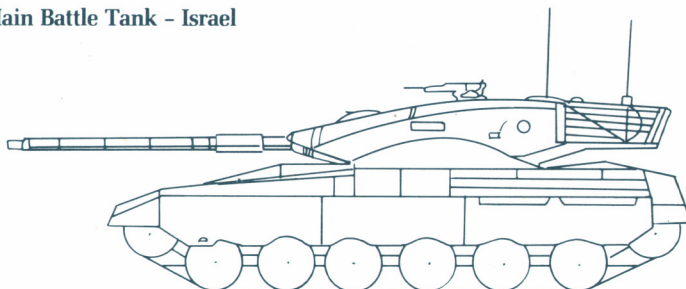

Weight: 66.0 tons
 Main Weapon: 105mm Rifled Cannon
 Secondary Weapon: three machineguns
 Armor: Heavy (steel/composite)
 Crew: 4
 Hull Length: 7.5 meters
 Hull Width: 3.7 meters
 Height: 2.8 meters
 Engine: 900 hp diesel
 Maximum Road Speed: 28.6 mph

The Merkava is Israel's first "home grown" battle tank, and a very original design. It is heavily armored, slow and carries the traditional 105mm NATO cannon designed 25 years ago. This philosophy is directly contrary to USSR design concepts, and fairly different from most western nations. However, Israel is designing from the greatest successful tank battle experience of any nation in the post-WWII world. Perhaps they know something we're ignoring?

UH-60 Blackhawk Transport Helicopter - USA

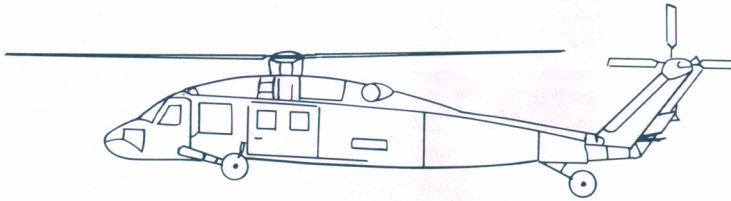

Weight: 8.1 tons
 Main Weapon: varies (often none)
 Secondary Weapon: none
 Armor: Light (Kevlar & composites)
 Crew: 3 + 11-14 troops
 Length: 15.3 meters (excluding rotor)
 Width: 5.5 meters (excluding rotor)
 Height: 3.8 meters
 Engine: two turboshaft jets, 2828 total shp
 Maximum Level Speed: 184 mph

[Illustration half scale]

The Blackhawk is the U.S. Army's new general-purpose helicopter and a worthy successor to the classic but aging UH-1 "Huey". The twin-engine design, light armor, and high crashworthiness make it a safe, reliable machine in combat conditions. Ground attack, night flying and ECM/ESM variants exist, as well as many other special-purpose designs. However, the Blackhawk lacks sophisticated fire control systems, so even the armed versions are nowhere near as potent in combat as the AH-64 Apache.

**Hughes 500MD Defender
Attack Helicopter - USA**

[Illustration half scale]

Weight: 1.6 tons
Main Weapon: four TOW missiles
Secondary Weapon: varies
Armor: none
Crew: 2
Length: 7.6 meters (excluding rotor)
Width: 3.2 meters (excluding rotor)
Height: 2.7 meters
Engine: one turboshaft engine, 425 total shp
Maximum Level Speed: 140 mph

The Defender is not used by the U.S. Army. It is an inexpensive attack helicopter for export to smaller Western nations. It currently serves in the Israeli, Kenyan, and South Korean air forces. Instead of the TOW anti-tank missiles as shown it can carry a three-barrel 7.62mm minigun (a gatling machinegun), 40mm grenade launcher, or 2.75" FFAR rocket pods. Options include a mast-top sight for the TOW (instead of the nose sight shown), FLIR night vision for the pilot, air-to-air missiles, and various computerized flying and combat aids.

EASTERN BLOC EQUIPMENT

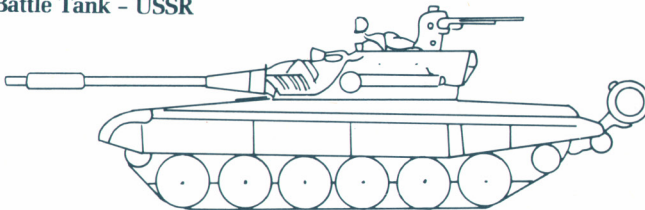
**T-74
Main Battle Tank - USSR**

Weight: 45.1 tons
Main Weapon: 125mm Smoothbore Cannon
Secondary Weapon: two machineguns
Armor: Medium (steel & laminate/composite)
Crew: 3
Hull Length: 7.0 meters
Hull Width: 4.8 meters
Height: 2.4 meters
Engine: 780 hp diesel
Maximum Road Speed: approx. 37 mph

This vehicle is still called the T-80 by the U.S. Defense Department, even though most other nations and sources (including Jane's) indicate the Soviet designation is T-74. Like all Soviet post-WWII MBTs it is low, rounded, and fast ("drives like a sports car" according to Israeli tankers). The 125mm cannon has a mechanical loader that eliminates the need for a fourth crewman. Sights and night-fighting equipment aren't up to Western standards. The armor is predominantly traditional steel plate, since the Soviets haven't discovered the secret of Chobham armor. The T-74 is an evolutionary improvement in a family that reaches back through the T-72 to T-64, T-62 and ultimately to the ancient T-55 of the 1950's.

BMP-2
Infantry Combat Vehicle - USSR

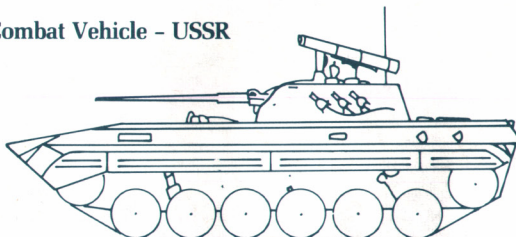

Weight: 16.1 tons
 Main Weapon: 30mm Rifled Cannon
 Secondary Weapon: AT-5 Spandrel Missile
 Armor: Light (steel)
 Crew: 3 + 7 passengers
 Hull Length: 6.7 meters
 Hull Width: 3.1 meters
 Height: 2.1 meters
 Engine: approx 350 hp diesel
 Maximum Road Speed: approx. 37 mph

The BMP-1 was a seminal concept in AFVs: an amphibious armored vehicle with a light cannon and anti-tank missile that carried an infantry squad. The BMP-2 is an improvement on the original. It has a new 30mm high-velocity gun and better anti-tank missile, but reduced infantry space (normally only six infantrymen are carried). According to Soviet doctrine, each BMP should carry a "Grail" (SA-7, SA-7B, or SA-14 surface-to-air missile) for defense against air attack. In action one of the infantrymen opens a top hatch on the rear deck, stands up, aims the Grail from his shoulder, and fires.

BTR-70
Armored Personnel Carrier - USSR

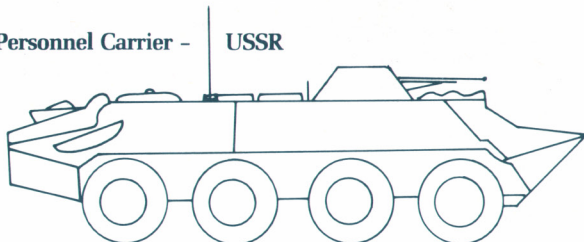

Weight: 12.7 tons
Main Weapon: two machineguns
Secondary Weapon: 30mm grenade launcher
Armor: Light (steel)
Crew: 2 + 9 passengers
Hull Length: 7.8 meters
Hull Width: 2.8 meters
Height: 2.5 meters
Engine: two 115 hp gas reciprocating
Maximum Road Speed: approx. 37 mph

This 8-wheeled carrier is an upgrade of the ancient BTR-60, designed prior to the BMP. Although a useful troop carrier, especially on roads or flat, firm ground, it has trivial armament, very weak armor, and an extremely poor transmission (due to the twin engines). Infantry must enter and exit the passenger compartment through two small roof hatches (most APCs use large rear doors). If the USSR had a Congress and/or a free press, ridiculous vehicles like this would be taken out of production (see the M247 Sergeant York DIVAD).

MT-LB **Armored Carrier - USSR**

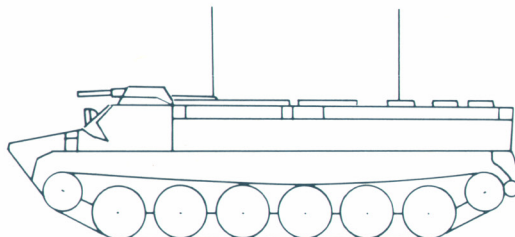

Weight: 13.1 tons
Main Weapon: one machinegun
Secondary Weapon: none
Armor: Light (steel)
Crew: 2 + 11 passengers
Hull Length: 6.5 meters
Hull Width: 2.9 meters
Height: 1.9 meters
Engine: 240 hp diesel
Maximum Road Speed: 38 mph

This general-purpose carrier was based on an unarmored tractor designed for use in swamps and arctic areas. It is an excellent cheap transporter with superior cross-country mobility. It has both roof hatches and rear doors for easy loading and unloading. Unlike the BMP, the MT-LB is not designed for fighting in the front lines.

ZSU-23-4 "Shilka"
Self Propelled AA Gun - USSR

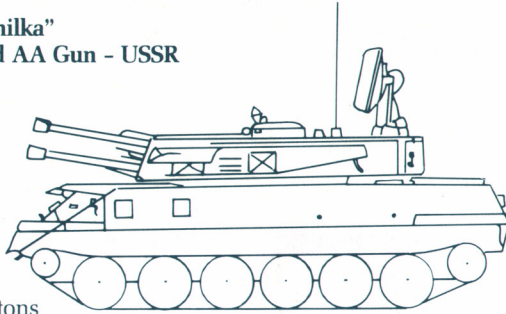

Weight: 20.9 tons
 Main Weapon: four 23mm Auto-Cannons
 Secondary Weapon: none
 Armor: Light (steel)
 Crew: 4
 Hull Length: 6.5 meters
 Hull Width: 3.0 meters
 Height: 3.0 meters
 Engine: 280 hp diesel
 Maximum Road Speed: 27 mph

The "Zoo" is another seminal design integrating powerful, rapid-fire AA guns with computerized radar fire control on a light tank chassis. The guns overheat quickly, and so are fired in 3 to 5 second bursts. Still, each burst puts 200 shells into the air! The original ZSU-23-4 design had mediocre radar that had trouble finding targets below 200' altitude. The newer ZSU-23-4M has a much improved radar system with better search and resolution capabilities. The guns can fire using optical sights if the radar is jammed. The ZSU-23-4 has been greatly feared by Western pilots.

ZSU-30-2
Self Propelled AA Gun - USSR

Weight: probably 20-30 tons
 Main Weapon: two 30mm Auto-Cannons
 Secondary Weapon: probably none
 Armor: probably Light (steel)
 Crew: probably 3-4
 Hull Length: probably 6.2-6.7 meters
 Hull Width: probably 3.0 meters
 Height: unknown
 Engine: probably a diesel
 Maximum Road Speed: probably 27-37 mph

[No illustration available]

Although it has not been displayed on parade, diverse sources suggest that the Soviet Union has a new and improved AA tank with twin 30mm guns. Details are not yet available. This design replaces the ZSU-23-4, now more than 20 years old. The heavier caliber 30mm guns should be able to do more damage at longer ranges against armored helicopters such as the AH-64.

ZSU-57-2
Self Propelled AA Gun - USSR

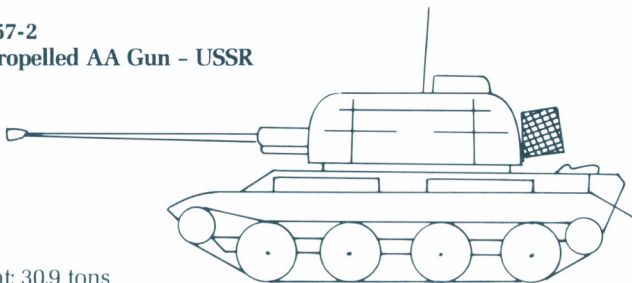

Weight: 30.9 tons
 Main Weapon: two 57mm Auto-Cannons
 Secondary Weapon: none
 Armor: Light (steel)
 Crew: 6
 Hull Length: 6.2 meters
 Hull Width: 3.0 meters
 Height: 3.0 meters
 Engine: 280 hp diesel
 Maximum Road Speed: 31 mph

This obsolete AA weapon uses an early 1950's tank hull and two late 1950's AA guns. The guns track slowly and lack radar ranging or control (everything is done optically or manually). However, the shells are quite powerful — a direct hit can seriously damage a plane or helicopter, even the armored A-10's and AH-64's. Large numbers were supplied to Soviet client states, who now use it primarily against ground targets.

S-60
57mm AA Gun - USSR

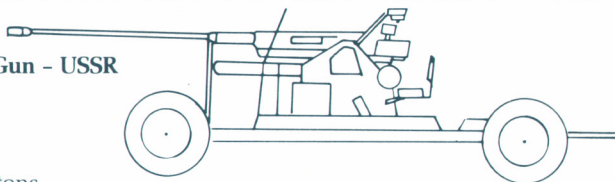

Weight: 5.0 tons
 Main Weapon: one 57mm Auto-Cannon
 Secondary Weapon: none
 Armor: none
 Crew: 7
 Length: 8.5 meters traveling
 Width: 2.1 meters traveling
 Height: 2.6 meters traveling
 Engine: none
 Maximum Road Speed: towed

This old but effective medium AA gun is still used worldwide by Soviet-equipped states. The gun can be fired using optical control. For greater accuracy a SON-9A fire control radar with a PUAZO-6/60 director can be attached. One or more guns can be tied into a search radar system for long-range accuracy. During the Vietnam War this system is believed to have been the single most effective destroyer of American aircraft.

ZU-23
23mm AA Gun - USSR

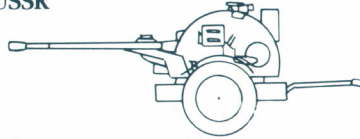

Weight: 1.1 tons
 Main Weapon: two 23mm Auto-Cannons
 Secondary Weapon: none
 Armor: none
 Crew: 2-3
 Length: 4.6 meters traveling
 Width: 1.8 meters traveling
 Height: 1.9 meters traveling
 Engine: none
 Maximum Road Speed: towed

This cheap, rapid-fire, short-range AA gun is used extensively by Soviet-supplied armies. It is relatively light for easy transportation and sets up quickly. The gun is considerably superior to machineguns and other ad hoc AA defenses, but is not designed for use with radar. Therefore its range is low and its accuracy against fast-moving targets is totally dependent on the gunner's skill.

SA-7, SA-7B or SA-14
Portable Surface-to-Air Missile - USSR



Weight: 20.3 lb missile (tube extra)
 Main Weapon: 5.5 lb fragmentation warhead
 Secondary Weapon: none
 Armor: none
 Crew: 1
 Length: 1.35 meter missile
 Width: 70mm missile diameter
 Height: (shoulder launched)
 Engine: Mach 1.5 solid fuel
 Maximum Road Speed: manpack

This IR-homing missile has been popular among Soviet-supplied armies and terrorists for years. The original SA-7 had an IR homing head that needed to fly up a jet exhaust, and was easily decoyed by flares and jammers. The SA-7B has an improved seeker that is less easily jammed, but still uses a small 5.5 lb. warhead. The new SA-14 is believed to have an even better seeker and larger warhead. The maximum range and altitude of these missiles is consistently underestimated in the West. For example, although an altitude limit of 1,500' is widely quoted, an SA-7 hit an Omani jet (in 1974) at 11,500 feet!

The SA-7, -7B, or -14 is carried by infantry units, used to defend ground installations, and carried inside BMP vehicles as their aircraft defense.

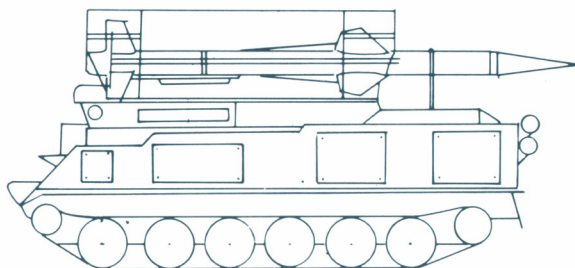
SA-6 "Gainful"**Self Propelled Surface-to-Air Missile Launcher - USSR**

Weight: 15.4 tons

Main Weapon: three SA-6 missiles

Secondary Weapon: none

Armor: Light (for crew only)

Crew: 3

Hull Length: 6.8 meters

Hull Width: 3.2 meters

Height: 3.5 meters

Engine: 280 hp diesel

Maximum Road Speed: 27 mph

This medium-range SAM system is commonly used by poorer Soviet-supplied nations against aircraft at low to medium altitude. The launcher vehicles travel and fire in cooperation with separate radar vehicles. One radar system searches for targets, then hands them off to a second fire-control radar that tracks the target, plus the missile once it is fired. The fire-control radar then sends commands to the missile that guide it to the target. If the radar control is jammed or destroyed the missile flies "blind" and is unlikely to hit anything. The SA-6 system is popular because the missiles and radar can move forward with combat troops, or be positioned where threats are greatest. However the radar and control technology are 1960's vintage and easily jammed. The missiles themselves are slow (Mach 1.5) and not very maneuverable.

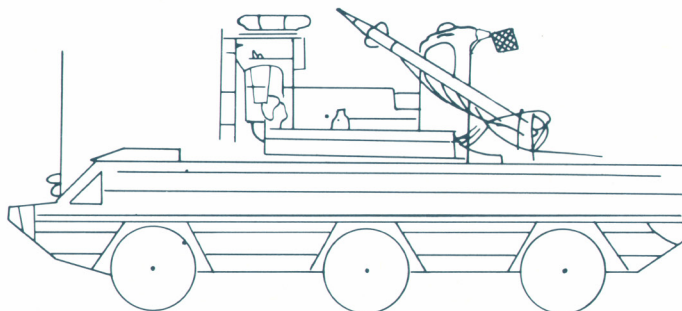
SA-8 "Gecko"**Self Propelled Surface-to-Air Missile Launcher - USSR**

Weight: approx. 25 tons
Main Weapon: four or six SA-8 missiles
Secondary Weapon: none
Armor: Light (for crew only)
Crew: 3
Hull Length: 9.0 meters
Hull Width: 2.9 meters
Height: 4.1 + meters
Engine: no reliable data
Maximum Road Speed: approx 37 mph

This sophisticated system was front-line equipment in the Warsaw Pact forces until recently. Exports have begun to select Soviet client states (including Syria and Iraq). The vehicle mounts its own tracking radars, but can work with separate search radar systems to acquire targets beyond visual range. The target is normally tracked with radar, but optical TV tracking is available if the radar is jammed. In early flight the missile is guided toward the target by the controller. As it closes in, an IR homing warhead switches on, providing another backup in case the radar guidance system fails. The missile can reach speeds over Mach 2 and is fairly maneuverable, but burns out rather quickly (maximum range is 12 kilometers). The vehicle can launch and control two missiles simultaneously and on different frequencies. The SA-8B system has six improved and more sensitive missiles cased in protective boxes.

SA-9 "Gaskin"
Self Propelled Surface-to-Air Missile Launcher - USSR

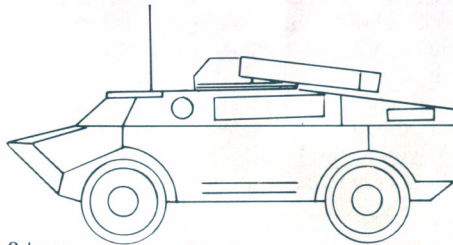

Weight: approx. 8 tons
Main Weapon: four SA-9 missiles
Secondary Weapon: none
Armor: Light (steel)
Crew: 2-3
Hull Length: 5.8 meters
Hull Width: 2.4 meters
Height: 2.2 + meters
Engine: 140 hp gas reciprocating
Maximum Road Speed: approx. 60 mph

This light armored vehicle is armed with short-range IR homing missiles. The missiles are aimed by the gunner using visual sights. The SA-9B has a simple radar to aid the gunner in locating targets. The missile itself is barely equal to the

SA-7. It has an even smaller warhead, but a larger minimum range and minimum altitude. The questionable value of this system was demonstrated in the 1981-82 Israeli air raids over Lebanon, where Israeli planes inflicted massive losses on entire Syrian batteries of these vehicles.

SA-11 "Gadfly"
Self Propelled Surface-to-Air Missile Launcher - USSR

Weight: approx. 20 tons

Main Weapon: four SA-11 missiles

Secondary Weapon: none

Armor: Light

[No illustration available]

Crew: 3-4

Hull Length: 6.5 meters

Hull Width: 3.0 meters

Height: 3.0 meters

Engine: 280 hp diesel (probably)

Maximum Road Speed: approx. 27 mph

This is the latest Soviet medium-range missile, designed to replace the SA-6 system. It can use the same or improved search and tracking radars. The missile homes on reflected radar signals, flies very fast (Mach 3) and is reasonably maneuverable. Because this system is quite recent, some sources believe it has a backup TV or laser tracking system as well as IR homing for terminal guidance.

SA-13 "Gopher"
Self Propelled Surface-to-Air Missile Launcher - USSR

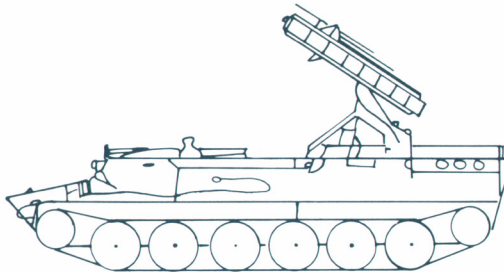

Weight: 13.8 tons

Main Weapon: four SA-9 or SA-13 missiles

Secondary Weapon: one machinegun

Armor: Light (for crew only)

Crew: 3-4

Hull Length: 6.6 meters

Hull Width: 2.9 meters

Height: 2.3 meters (travelling)

Engine: 240 hp diesel

Maximum Road Speed: approx. 34 mph

This is a completely redesigned successor to the SA-9 Gaskin. It has a small search radar and fires IR homing missiles from a converted MT-LB vehicle. These missiles are new, improved designs that jump between two IR frequencies to counteract jamming and flares. The homer is sensitive enough to find "hot spots" on aircraft skin caused by air friction, rather than simply chasing the exhaust. Introduced in 1980, the SA-13 missile is the USSR's best ground-launched IR homing weapon now in active service. Versions of the vehicle have been supplied to the Warsaw Pact and selected Soviet allies, but often the actual missiles are the poor SA-9s, rather than the state-of-the-art SA-13s!

Mi-24 "Hind" Attack Helicopter - USSR

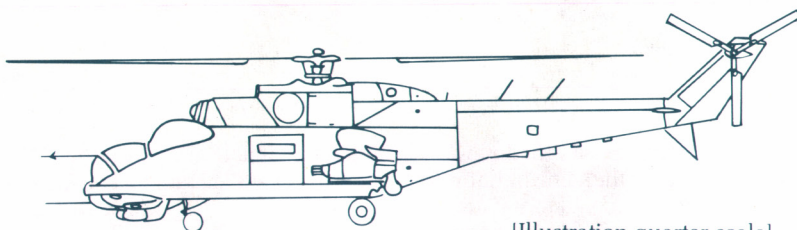

[Illustration quarter scale]

Weight: 12.1 tons

Main Weapon: Varies

Secondary Weapon: 2,800 lbs of bombs, rockets, etc.

Armor: Light (titanium?)

Crew: 3

Length: 33.7 meters (excluding rotor)

Width: approx. 16 meters (excluding rotor)

Height: 3.2 meters

Engine: two Lotarev D-136 turboshaft jets, 11,400 total shp

Maximum Level Speed: 183 mph

This large, fast, heavy, armored helicopter is literally a "flying battlecruiser." The D model has a 12.7mm gatling gun turret beneath the nose as its main weapon. The E model has four fixed 23mm cannons while the turret houses laser guidance for AT-6 "Spiral" anti-tank missiles. An F model carrying IR homing missiles for air-to-air combat may exist (the U.S. Defense Department calls it the Mi-28 Havoc). The "Hind" is faster than any western helicopter, but much less maneuverable. Although the D model (illustrated above) has a nose turret, it lacks an equivalent to IHADSS and TADS. Therefore, in swirling air-to-air combat it is limited to forward firing, like the E model. No information exists on the guns and cannons of the "F" model, much less the fire control system used.



REGIONAL DEPLOYMENTS of the AH-64A Apache

SELECTING REGIONS

The five flying regions are listed in order of difficulty, from the easiest (Training in the USA) to the most difficult (Western Europe). U.S. Army regulations require that all new pilots first report to the training area in the USA. This is only sensible. If you're new, follow those orders and work through both "Beginner's Tutorials." Only then are you ready for combat duty. Southeast Asia or Central America should be first, then the Middle East or Western Europe.

TRAINING IN THE USA



Background: This area is designed to help teach you flying, how to use weapons, and how to use defenses. All enemies fire “blanks.” You can experiment and learn without worrying about damage. LEARN TO FLY HERE FIRST. Even experienced combat fliers occasionally return here to experiment with new tactics or try out new flight maneuvers.

The Apache flight training area has a central heliport with various dummy targets surrounding it. A comprehensive combat simulation environment exists to give pilots realistic practice flying in battle conditions, but without suffering any battle damage. This area is ideal for learning to fly, learning to identify Soviet-built equipment and installations, and to gain skill on both the attack and defense.

Mission Profiles: Use the “Beginner’s Tutorials” on your first flights. Then continue to practice until flying, attacking, and avoiding threats is second nature. The heliport does not use passwords and countersigns.

Opposing Equipment: This training area includes dummies and simulations of most Soviet-made equipment. It has SA-7, SA-8, and SA-9 missile launchers, ZSU-23-4 AA tanks and S-60 57mm anti-aircraft guns, T-74 and BMP tank targets, infantry and bunker targets, and three typical Soviet installations: an HQ, a supply depot and a forward heli-base. None of these have active weapons. You cannot be shot down.

Advice from the Sergeant Major: “I’ve seen many good pilots go to war too soon. It’s like lambs to the slaughter. Take my advice, sir, and get lots of practice hours. Flyin’ a gunship is a tricky job at best, and downright difficult when a dozen bad guys are tryin’ to toast you. No disrespect intended, sir, but the better you are on the practice range, the better your chances of living through your first battle.”

“Don’t be too upset if your first flight ends badly. Everybody has trouble with choppers at first. Give it time and you’ll get the hang of it”

SOUTHEAST ASIA

1st Air Cavalry Division

Background: In 1965 U.S. combat troops are sent on active duty to fight communist guerilla forces in Southeast Asia. The first heliborne unit in history swings into action in the Ia Drang Valley. Helicopter transports and gunships are invaluable in finding the elusive enemy. Communist regular and guerilla forces lack sophisticated weapons, but the early UH-1 and AH-1 choppers lack armor protection — a stray bullet could and did disable a million-dollar flying machine. Fortunately, the AH-64A Apache is armored.

Mission Profiles: Your main problem is finding the enemy. Only occasionally will you encounter strong AA guns and SAM defenses. Mission targets are mostly enemy troops and installations, sometimes a bunker complex. Hellfires are only needed against the bunkers. Otherwise cannon and rockets are perfectly adequate.

Opposing Equipment: Enemy AA weapons are primarily 23mm and 57mm gun sites. Third line guerilla forces have no radar, while second and first line NVA troops have radar for their 57mm S-60 sites. The only SAMs in use against



helicopters are outmoded SA-7s. Most of these are used to defend enemy bases. Intelligence reports no enemy helicopters in the region, and will update you if the situation changes.

Advice from the Sergeant Major: "Be glad you've got an armored chopper — baddies in the bush aren't a serious danger. On the other hand those 23's and 57's can be nasty. The ones without radar are especially irritating — they don't trip your warning lights. If you start collecting flak, get low quick and dodge. Then decide whether you want to hunt them down or take another route."

CENTRAL AMERICA

82nd Airborne Division

Background: In October, 1983 America mounted an air-land-sea invasion of Grenada to eliminate a gradual communist takeover. The government of El Salvador, an American ally, is struggling to remain coherent. Haiti has just eliminated a hated dictator but has huge internal troubles. The anti-American government of Nicaragua is under guerrilla attack by "Contras" based in Honduras and Costa Rica. Border clashes with U.S. allies could lead to calls for



American military assistance. Cuba, a strong Soviet client-state for decades, still fears an American invasion. In all cases, the unit ready to move fastest is the 82nd Airborne Division. Men and supplies can be parachuted into action while mobile fire support (the AH-64A Apache) flies to freshly-cleared firebases and heli-pads.

Mission Profiles: Here the enemy has a conventional army, but the battlefield is irregular and confused. You won't find a well-defined front line, but you will find organized groups of regular enemy troops, supported by AA guns, SAMs, and Hind helicopters. Beware the high daytime temperatures and humidity, which greatly reduce carrying capacity.

Opposing Equipment: The enemy forces are primarily infantry, supported by a few BMP armored vehicles and ZSU-23-4 or ZSU-57-2 AA tanks. The SA-9 Gaskin missile carrier is the standard "heavy" SAM vehicle, with a few improved SA-9B's available to first grade troops. Virtually all enemy infantry and installations have SA-7 Grails, some have the improved SA-7B. Both 23mm and 57mm guns are commonly used for air defense. All 57mm guns use search radars, and all but the worst-equipped have fire control radar too. None of the 23mm guns have radar. Mi-24 Hind helicopters are available in small numbers to most communist armies, and will probably make an appearance on the battlefield.

Advice from the Sergeant Major: "Sir, these guys are *not* primitive villagers from the boondocks. They've got decent weapons and know how to use them. If you get a radar warning, it's probably a ZSU-23-4 or a 57mm AA gun. Don't just jam them, hit them before they switch to optical and hit you! Like Southeast Asia, beware of the 23mm's and older ZSU's that use optical control — they don't warn you before they fire! When loading up, carry lots of 30mm. Hellfires are useful at times, but don't go crazy with them."



101st Air Assault Division

Background: The Middle East is still the world's trouble spot. Israel and Syria duel in desultory fashion over southern Lebanon and their common border, the Golan Heights. The Iran-Iraq war continues to hold the danger of a losing Iran seeking revenge by closing the Straits of Hormuz to oil traffic. Worse, Iranian-style religious radicalism might surface in any nearby Moslem state, triggering a civil war. If an American friend calls for aid, or international straits need to be cleared, in America's "Central Command" reaction force the key unit is the 101st Air Assault Division. Formerly a parachute division, it's now an experimental hybrid practicing the "Air-Land 2000" mobile warfare of the future. Naturally, the AH-64A Apache is a key player on this new team.

Mission Profiles: Here you face modern armored forces lavishly equipped by the Soviet Union. Fortunately, this is the enemy the Apache was designed to destroy. Careful weapons loading is paramount because high ground level and very high temperatures conspire to reduce your carrying capacity. The majority of enemy targets will be armored vehicles, making the Hellfire an extremely important weapon.

Opposing Equipment: Most opponents have numerous tanks and personnel carriers, protected by ZSU's, SA-8's and SA-9's. Enemy first line forces use the ZSU-23-4M AA tank, SA-8B and SA-9B SAM vehicles, S-60 57mm guns with full radar, and outfit their infantry with SA-7B improved Grails. Enemy second line forces have the older ZSU-23-4 with poorer radar, the older SA-8 and SA-9 SAMs, no fire control radar on the 57mm gun sites, but still have the SA-7B improved Grails. Enemy third line forces are lucky to field the ancient ZSU-57-2 (with no radar), only have the SA-9 SAM vehicle, use older SA-7 Grails, and also lack fire control radar for the 57mm guns. Enemy air forces have a few Mi-24 Hind helicopters, so you may see some occasionally.

Advice from the Sergeant Major: "Sir: these fellows can be nasty, especially the first and second line troops with those SA-8 Geckos. Only the third line ZSU-57-2 and occasional 57mm gun site relies on optical control. However, their modern

equipment does set off your warning lights. So the enemy's better weaponry works in your favor too. Probably the tough part is the weight limit, especially on a hot day. Therefore, I advise against Sidewinders. If you meet a Hind, get him with the trusty 30mm. Hellfires will be useful against all those armored vehicles. Some guys I know don't carry FFARs, but that may be going too far... Sorry, sir, humor ain't my strong point"

WESTERN EUROPE



3rd Armored Division

Background: For over 40 years NATO forces across Germany have faced the Warsaw Pact. Both sides are armed to the teeth, ready for war. A number of U.S. Army divisions are stationed on this line, including the 3rd Armored of the U.S. V Corps. Trouble anywhere could lead to escalating tensions. When tensions are high, one itchy trigger finger could start a conventional war between the two superpower alliances. It is imperative that NATO stop the Russian steamroller without using nukes. Otherwise the President could be reduced to a choice between Russians in Paris, or nuclear winter for all!

Mission Profiles: Anything and everything can and will happen in this desperate free-for-all. The only sure thing is that the enemy is fully armored and moving fast

under an umbrella of sophisticated flak, SAMs, and helicopter gunships. Soviet military forces may not be very creative, but they are numerous and brave. They will keep coming until you stop them!

Opposing Equipment: The Warsaw Pact 1st Line Soviet Divisions have the very latest equipment: ZSU-30-2 AA tanks, SA-11 and SA-13 SAMs, and SA-14s for all the infantry and BMPs. The 2nd Line allied troops from East Germany, Poland and Czechoslovakia have the best of the previous generation: the ZSU-23-4M, SA-8B and SA-9B, and the SA-7B improved Grails for BMPs and infantry. Third line troops are mainly found in quiet areas, since they're Soviet reserve divisions or hastily organized allied troops. They have older ZSU-23-4's, unimproved SA-8's, SA-9's, and SA-7s. A few S-60 57mm guns can be found near important installations in all cases, and all but the third line troops have both search and fire control radar for these gun sites.

Advice from the Sergeant Major: "Well sir, this is the big time. We're up against the first team here. They've got everything including the kitchen sink, and they'll use it. Anywhere else is a piece of cake compared to this. But our boys on the ground are badly outnumbered and need us to even up the odds. Your best chance is at night, since their night vision stuff isn't as hot as ours. Load up on Hellfires — the Pact has hordes of armored vehicles out there. On a good night you might bag your fourteen in one sortie! Don't forget Sidewinders either. Hinds are as thick as flies around here."

AAA (Anti-aircraft)
AA (Anti-aircraft)
Aft: Alternate

GLOSSARY

- AAA (Anti-aircraft Artillery):** A gun designed to shoot down flying craft.
- AA (Anti-aircraft):** A popular shortening of "AAA".
- Aft:** Alternate term for "after" or "behind", originally nautical.
- AFV (Armored Fighting Vehicle):** Any armored vehicle designed for use on the battlefield. Includes tanks, personnel carriers, self-propelled artillery, self-propelled anti-aircraft guns, etc.
- AGM-114A (Air-to-Ground Missile, Type 114, Version A, "Hellfire"):** Standard U.S. Army laser-homing armor-piercing missile.
- AIM-9L (Air Interception Missile, Type 9, Version L, "Sidewinder"):** Standard U.S. Air Force IR-homing air-to-air missile.
- Anti-Torque Rotor:** Also known as the "tail" rotor, used to stabilize yaw on a helicopter.
- APC (Armored Personnel Carrier):** An armored vehicle designed to carry and protect infantrymen. It may have wheels or tracks, and it may or may not be armed.
- Avionics:** All electronic equipment that either informs a pilot about his flying craft, or helps him control that craft.
- Autorotation:** A technique for landing a helicopter without engine power.
- Ballistics:** Study of projectile performance; i.e., the hows and whys of bullets and shells flying through the air.
- BMP (Boevaya Mashina Peknota — Infantry Fighting Vehicle):** Russian armored personnel carrier with a powerful armament. It permits an infantry squad to fight while riding the vehicle, or fight on foot with the vehicle providing fire support not unlike a tank. Popularly known as the "Bump" by American serviceman.
- Bunker:** A fortification to protect ground troops and weapons. It generally has a very thick side and roof made of earth, concrete, and/or steel.
- Chaff:** Thousands of tiny strips of metal, designed to reflect radar waves. Chaff is scattered in a "cloud" to confuse radar.
- Collective:** Helicopter flight control that changes the angle of attack of the rotor, and thus indirectly changes the lifting force of the rotor.
- CRT (Cathode Ray Tube):** Generic term for any TV and/or computer display screen.
- Cyclic:** Helicopter joystick flight control that controls pitch and roll.
- FFAR (Folding Fin Aerial Rocket):** Abbreviation for lightweight unguided rockets commonly used by ground attack planes and helicopters.
- Flak:** Nickname for anti-aircraft guns or their exploding shells, derived from the German word for anti-aircraft gun.
- Flares:** A generic term for a heat source designed to mimic the heat signature of a flying craft, and thus confusing IR-homing weapons.

- Fore:** Alternate term for “forward” or “ahead”, originally nautical.
- HEDP** (High Explosive, Dual Purpose): A type of high-explosive ammunition that includes an armor-penetrating capability.
- Hellfire:** Standard U.S. Army nickname for a type of air-to-ground missiles.
- HIND:** NATO code-name for the Russian-built Mi-24 series of helicopters
- IFV** (Infantry Fighting Vehicle): Western equivalent of the Russian BMP: an armored personnel carrier with a powerful armament. It permits an infantry squad to fight while riding the vehicle, or fight on foot with the vehicle providing fire support not unlike a tank.
- IHADSS** (Integrated Helmet and Display Sighting Sub-System): Pilot and gunner’s helmets that include position sensors and display monacle.
- INS** (Inertial Navigation System): A device that computes the current location of a craft and displays this position to the pilot. It generally includes a system for selecting a destination point and displaying the proper course to reach that point.
- IR** (Infra Red): An area of the electromagnetic spectrum where sensors detect heat instead of visible light.
- Knots:** A measure of velocity, in nautical miles per hour. 1 knot = 1.14 statue miles per hour.
- Kilometers:** Metric measure of distance, 1609344 kilometers = 1 mile.
- LZ** (Landing Zone): An area of ground where airborne troops will land, including paratroop drops and/or helicopter assaults.
- Port:** Left side of a craft, originally nautical.
- SAM** (Surface-to-Air Missile): A missile designed to destroy flying craft.
- Sidewinder:** Standard U.S. Air Force nickname for a type of IR-homing air-to-air missiles (all AIM-9 missiles).
- Skid:** For a helicopter, “sideways” motion — motion not parallel to the fuselage of the craft.
- Starboard:** Right side of a craft, originally nautical.
- TADS** (Target Acquisition & Designation System): An integrated system for sighting and tracking targets that interfaces with weapons themselves.
- Torque:** Rotational force in a turbine engine.
- TOW** (Tube-launched, Optically-guided, Wire-controlled): Standard U.S. Army armor-piercing missile system of the 1960’s and 1970’s.
- Translational Lift:** Lift caused by motion of the entire helicopter, as opposed to lift caused by blades within the rotor.
- VSI** (Vertical Speed Indicator): Cockpit dial that shows the rate of ascent or descent. If the craft is travelling level, the VSI is zero (level).
- ZSU** (Zenitnaia Samokhodnaia Ustanovka — Self-propelled anti-aircraft mount): Russian armored vehicle armed with anti-aircraft guns. Popularly known as a “Zoo” by American servicemen.

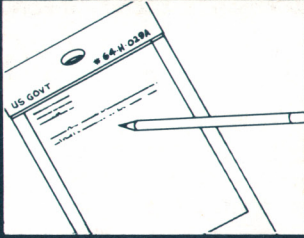

NOTES

At MicroProse GUNSHIP was an enormously long and complex project that took triple the estimated time and quadruple the original number of people. Simulating low-level helicopter combat, especially on 8-bit computers such as the C-64 or Apple II, was an outrageously complex job. Each member of the design team played a crucial role in developing this amazing simulation. Andy Hollis worked his optimizing magic to create a 3-D graphics system that made hills "solid" and yet ran fast enough for smooth real-time flight, not to mention his realistic handling of helicopter flight mechanics. Expert artists Michael Haire and Michele Mahan worked with programmer Gregg Tavares to conjure up a superb cockpit and the many attractive starting and ending screens. Gregg also contributed the missile flight logic. Sid Meier pulled his usual rabbits out of hats when it came to handling weapons logic and the "artificial intelligence" of the enemy. Credit (or blame) for the concepts, research, game scenarios, and overall coordination goes to Arnold Hendrick.

MicroProse could have taken the easy way out, like most software publishers now jumping onto the "flight simulator" bandwagon. However, we didn't want GUNSHIP to be another unrealistic arcade-style "shoot 'em up" that bears little resemblance to actual planes or helicopters. For example, one "helicopter simulation" from a well known firm even has the cyclic and collective controls reversed!

Instead, we spent the time and effort to make GUNSHIP a faithful and realistic representation of the actual AH-64A, the most sophisticated combat helicopter in the world. Unfortunately, this means GUNSHIP cannot be played like an arcade game. Don't expect to immediately fly around Western Europe blasting top quality Soviet troops off the map.

This simulation includes all the major systems and capabilities of the actual AH-64A. The only major concession to playability we added was the INS mapping system. The current AH-64A only has a simplified INS system. On the actual machine the pilot does not have a computerized map. He keeps a paper map in his lap, looks up coordinates on it, and punches them into his digital unit. However, the latest AH-1 variants have a more sophisticated INS system similar to one shown here. It's not unlikely that this will be added to the Apache too. As you can see, it's extremely convenient!

In GUNSHIP the tasks of pilot and gunner are combined into one activity and a single cockpit layout. The battle area is about 80 square miles in size. In addition to showing the major terrain features, such as hills, roads, and streams, the visibility logic includes incidental ground cover such as bushes, trees, small rolls in the ground, etc. in its internal calculations.

The actual AH-64A helicopter is quite new. Parts of it are still secret. MicroProse does not wish to compromise military security and needlessly endanger the lives

of gunship crews. We were careful to research all information from unclassified sources. Although we talked to real helicopter pilots, we did not solicit or use any classified information. In some cases this forced us to make educated guesses, rather than using hard data. However, a vast array of material about modern weaponry and warfare has been published in the USA and abroad, especially in England. In some cases our conclusions differ with the public position of the United States Department of Defense and/or the U.S. Army.

We're sure you'll enjoy the challenge of flying GUNSHIP, a "real" combat simulation. Spread the word if you prefer the authenticity of GUNSHIP, rather than unrealistic fast-action games. Let us know and let your software dealer know. Your purchasing dollar is your "vote" for future products. Each enthusiast who buys GUNSHIP helps us create more great simulations. This "dollar vote" is the real importance of software piracy. People who use pirated copies literally discourage us from producing future products of that type. Naturally we try to discourage piracy, but your help and support is much appreciated.

Good flying in the Apache's happy hunting grounds. May you win the Congressional Medal of Honor!

— the Gunship design team:
Arnold Hendrick, Andy Hollis, Gregg Tavares and Sid Meier

CREDITS

Game Design:

Arnold Hendrick & Andy Hollis

Software Development:

Andy Hollis, Gregg Tavares, Sid Meier

Software Graphics:

Michael Haire, Michele Mahan, Kimberly Disney

Technical Advisors:

William Force Jr., James Noe

Playtesting:

Bruce Meier, Jim Karl, Alan Roireau, John Harris, Bill Stealey,
Guy Watkins, Steve Byrne, Frank Szilagyi

Documentation: Arnold Hendrick

Manual Graphics: Michael Haire, Kimberly Disney

Cover Painting: Ed Valigursky, David Phillips

Typography & Layout: The Composing Room, Inc.

COPYRIGHT NOTICE

COPYRIGHT ©1986 BY MICROPROSE SOFTWARE INC., ALL RIGHTS RESERVED. This manual and the computer programs and audiovisuals on the accompanying floppy disks, which are described by this manual, are copyrighted and contain proprietary information belonging to MICROPROSE SOFTWARE, INC. No one may give or sell copies of this manual or the accompanying disks or of listings of the programs on the disks to any person or institution, except as provided for by the written agreement with MICROPROSE SOFTWARE, INC. No one may copy, photocopy, reproduce, translate this manual or reduce it to machine readable form, in whole or in part, without the prior written consent of MICROPROSE SOFTWARE, INC. Any person/persons reproducing any portion of this program, in any media, for any reason, shall be guilty of Copyright Violation, and shall be subject to civil liability at the discretion of the copyright holder.

WARRANTY AND LIABILITY

Neither MICROPROSE SOFTWARE, INC., nor any dealer or distributor makes any warranty, express or implied, with respect to this manual, the disk or any related item, their quality, performance, merchantability, or fitness for any purpose. It is the responsibility solely of the purchaser to determine the suitability of the products for any purpose. To the original purchaser only, MICROPROSE SOFTWARE, INC. warrants the media to be free from defects in material for 90 days. If during that period a defect should occur, the software may be returned to MICROPROSE SOFTWARE, who will replace the media at no charge. If at any time after the initial 90 day period your media becomes defective, the media may be returned to MICROPROSE SOFTWARE for replacement at a \$10 service charge. To ensure identification the original purchaser must complete and mail the Registration/Warranty card enclosed in this product. In no case will MICROPROSE SOFTWARE, INC. be held liable for direct, indirect or incidental damages resulting from any defect or omission in the manual, or other related items and processes, including, but not limited to, any interruption of service, loss of business, anticipated profit, or other consequential damages.



2, Market Place, Tetbury, Gloucestershire GL8 8DA

Tel:(0666)54326

Fax:(0666)54331 Tlx:43422MPS UK G



2, Market Place, Tetbury, Gloucestershire GL8 8DA

Tel:(0666)54326

Fax:(0666)54331 Tlx:43422MPS UK G