

TECHNICAL  
ORDER NO: **F19-M035-1**

SEPTEMBER 1987  
CHANGE 0

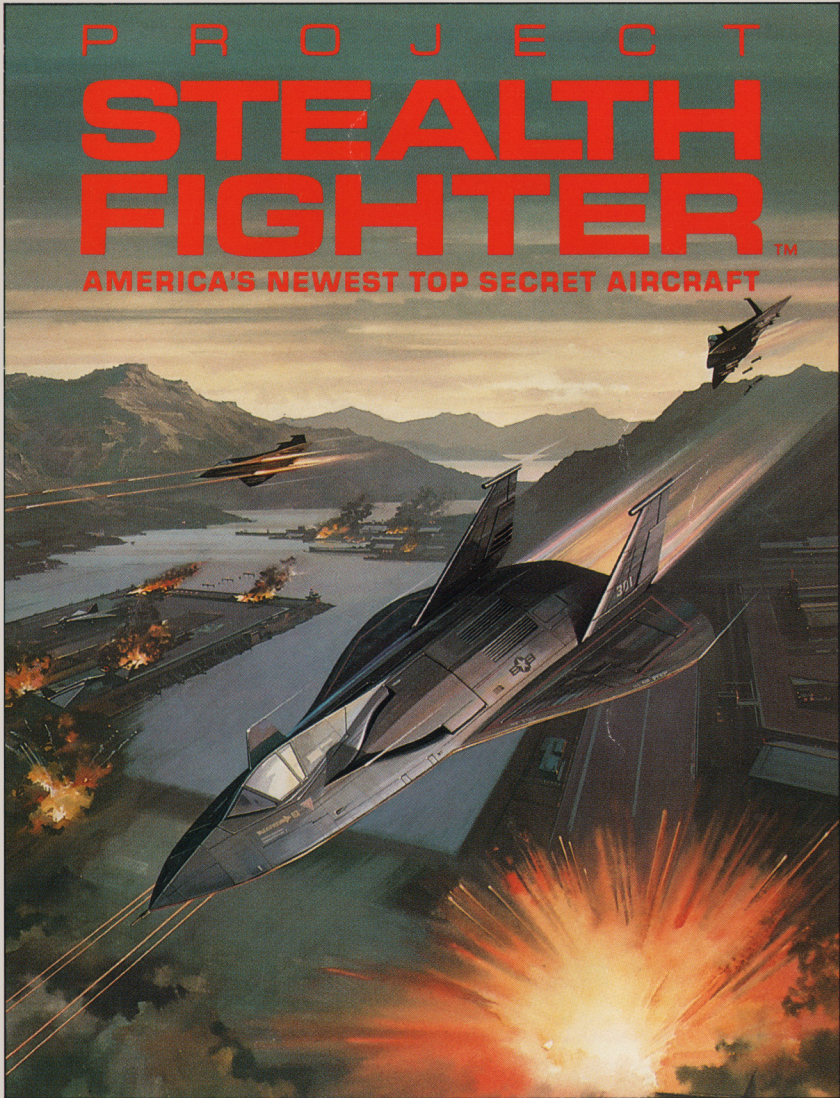

**OPERATIONS MANUAL**

PROJECT:  
**STEALTH FIGHTER**

The F-19 Simulation  
from MicroProse

**Project: Stealth Fighter** is MicroProse's simulation of the most sophisticated aircraft design in the world. You control the modern high-tech wizardry of the most formidable fighting plane in the world today: the all-but-invisible *Stealth Fighter*.

**Project: Stealth Fighter** gives you full aerodynamic control and 3-D out-the-cockpit graphics combined with a realistic HUD (head-up display). Your modern cockpit has color and monochrome screens, threat display and strip gauges. Aside from the control stick itself, this sophisticated warplane has over 30 other controls including dual tracking modes, jammers, four weapon bays and fully functional INS (inertial navigation system)!

**Project: Stealth Fighter** includes training for bombing and aerial dogfighting, as well as general flying skills. Once you master these skills, you can fly the "real thing" in one of four regions in the world: Libya, the Persian Gulf, the North Cape, and Central Europe. You select your armament from a host of missiles, laser-guided bombs, cluster weapons, fuel-air explosives, cannons, or peaceful reconnaissance cameras! Included are more than 100 different missions and thousands of armament options.

---

---

# PROJECT: STEALTH FIGHTER™

F-19 Stealth Fighter Simulation

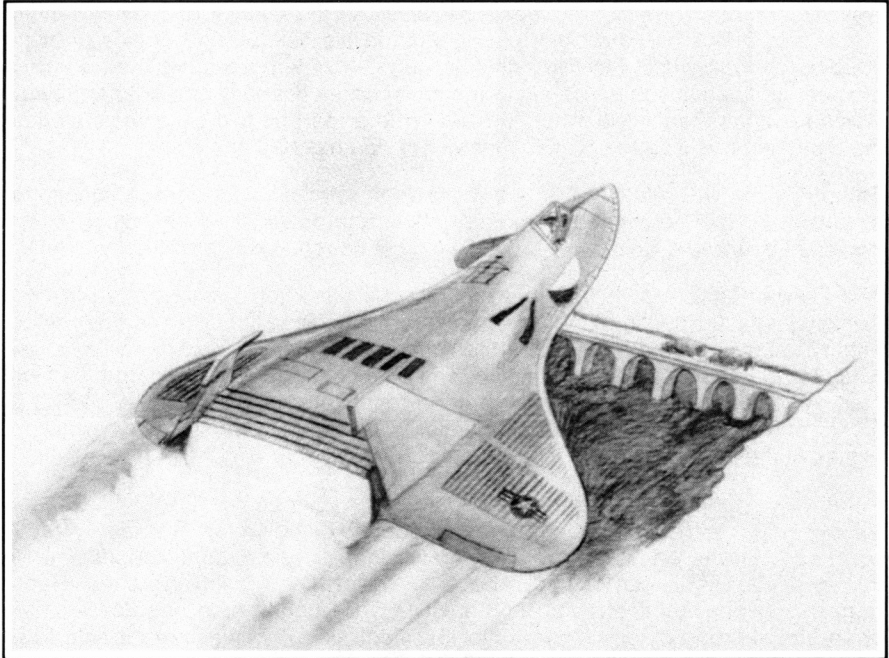

## **OPERATIONS MANUAL F19-M035-1**

Change 0, September 1987

Copyright ©1987 MicroProse Software  
180 Lakefront Drive, Hunt Valley, MD. 21030  
(301) 771-1151

PROJECT: STEALTH FIGHTER is a trademark of MicroProse Software, Inc.

Tandy, Atari, Apple, IBM, Commodore 64 and Amiga are registered trademarks of Tandy Corporation, Atari Inc.,  
Apple Computers Inc., International Business Machines Inc., and Commodore Business Machines Inc.

---

---

---

---

## Introduction



On a moonless night a huge C-5A Galaxy transport plane touches down in Saudi Arabia and taxis to a distant hanger guarded by DIA (Defense Intelligence Agency) operatives. A large black object is rolled from the Galaxy into the hanger. Under red night-lights the hydraulic whine of unfolding wings is counterpointed by the hum of fuel tanker trucks pumping aviation gas, while sweating ground crewmen hoist bombs and missiles into weapons bays. As the Galaxy rolls away, an Air Force pilot climbs into the black plane, puts on his helmet, and begins preflight checkout. Minutes later the distinctive whine of F404 turbofans fills the hanger. A strange, rounded shape noses out of the dark hanger doorway and onto a runway. A hand pushes the throttle to full forward. With a roar the two big turbojets hurtle the craft airborne. Another Stealth Fighter mission has begun.

Tomorrow the U.S. Navy will stage air raids in retaliation for Iranian-sponsored terrorism. To prevent interceptions, air battles and potential military disaster, the Iranian planes at the Shiraz military airfield must be rendered harmless.

The Persian Gulf rolls 35,000 feet beneath the black jet. Off to the left are the twinkling lights of dueling Iraqi and Iranian artillery. Blue light bathes the cockpit: enemy radar is awake tonight, but the American fighter is returning a signal too weak for the enemy radar to perceive. The pilot checks his position and his flight plan. A yellow light blinks: they got a good radar return then. Will they alert their SAMs and interceptors? It's all academic as the fighter's nose rolls downward, aiming at the military base on the outskirts of Shiraz.

Plunging downward at full throttle, a sonic boom rolls behind the dark avenger. Yellow goes to red as the Iranians suddenly discover an intruder directly overhead. Sirens erupt, sleepy SAM crews leap to their radar consoles while fighter pilots tumble out of bed. Above, the pilot flips arming switches. Radar targeting symbology flashes up on his HUD while underneath bay doors whine open and weapon pylons extend into the night sky. A Maverick missile's FLIR sensor turns on and the pilot guides it onto the heat signature of an the Iranian HAWK battery controller. In a few seconds the missile's brain locks onto the target and its engine flares bright in the sky. Simultaneously below an alert Shi'ite commander launches his first HAWK missile at the intruder.

The HAWK's control-guidance beams flash warnings in the cockpit. An IR strobing decoy erupts behind the intruder within a cloud of aluminum chaff. The HAWK attacks the cloud and explodes far behind the stealth fighter. Seconds later the slower-travelling Maverick hits the SAM controller in its concrete bunker, wrecking it and disabling the entire battery.

The black fighter rolls steeply, airbrakes out. Its sonic boom explodes ahead of it, crashing over the airfield like the thunder of the gods. At 1,200 feet altitude two Durandals drop from the weapons pylon, chutes springing free at the tail of each. The bombs nose downward, floating in air over the runway. Then rocket motors

---

---



---

---

explode and the bombs leap toward the ground, armored heads cutting through the thick concrete. Three feet down the warheads go off, hurling slabs of concrete in all directions.

The American pilot loops around and dives over the runway again. Two huge craters sit squarely on the middle, while nearby a number of carelessly parked jets are crumpled under pieces of concrete. A major unit of the Iranian air force is now grounded, unable to fly until major repairs are made to the runway. In a single blow over forty enemy aircraft have been rendered harmless.

The American climbs back to 35,000 feet, closes his bays and switches off his targeting radar. To the military search radars below, watching in helpless fury, the intruder seems to climb into space and disappear. Interceptors vectoring in from other bases block the airwaves with confused chatter. The American pilot smiles and throttles back for the slow cruise home, another Stealth Fighter mission accomplished.

---

---

# Table of Contents



02	Introduction	34	Equipment & Tactics
06	Quickstart	34	Aerodynamics & Flight
		36	Basic Forces
06	Operating Instructions	36	How Lift Varies
06	Preflight Briefing	36	The Effect of Roll
08	Controls	37	Special Situations
08	Head-Up Display (HUD)	37	Military Landings
10	Cockpit Control Panel	39	Radar & Stealth Tactics
13	Flight Controls	39	Radar
14	Combat Systems Controls	40	Stealth Technology
16	Basic Flying	41	Stealth Tactics
16	Takeoff	43	Weapons & Combat Tactics
17	Flight	43	Air-Ground Attack Techniques
18	Straight-in Landing	45	Air-Air Duels
19	Basic Weapons Use	53	Surface-Air Missiles (SAMs)
19	Types of Weapons	55	Weapons Data
19	Identifying Targets	55	USAF Ordnance
20	Firing 20mm Cannons	63	Surface-Air Missiles (SAMs)
21	Firing Air-to-Air Missiles	63	Air-Air Missiles (AAMs)
22	Firing Air-to-Ground Missiles		
23	Dropping Laser-Guided Bombs	66	Regional Briefings
24	Dropping Unguided Bombs	66	ONC Map Coordinates
25	Using Recon Cameras	66	Libya Training
26	Using Extra Fuel	67	Libya
26	Postflight Debriefing	71	The Persian Gulf
26	Ending a Mission	76	The North Cape
27	Promotions, etc.	80	Central Europe
28	Saving Your Record & Ending		
		86	Common Military Aircraft
29	Tutorial: Training for Libya	86	Key to Aircraft Statistics
30	Planning the Mission	86	American-built Warplanes
30	Takeoff from the CV America	98	Russian-built Warplanes
31	Approaching Ras Lanuf		
32	The Attack	111	Appendix
32	The Return Flight	111	Glossary
		113	Designers' Notes
59	The F-19 Stealth Fighter		

---

---

## Quickstart



To fly your Stealth Fighter as soon as possible, use the following procedure:

- 1. Load the disk:** See the "Loading Instructions" in the Technical Supplement.
- 2. Answer the aircraft identification quiz:** Check the back part of this manual ("Common Military Aircraft") to see what aircraft is illustrated. If you give a wrong answer, you are automatically sent for training. If you give the correct answer, you are given a complete selection of all options.
- 3. Select training:** Among the starting options, select the following choices:
  - Begin a Mission
  - Libya Training
  - Limited War
  - Bombing Practice
  - Green Opponents
  - No Crashes
  - Mission Briefing
  - Arm Your Plane
  - Arming Complete

This starts you in a training simulator. Enemy forces can attack you, but they do not inflict any damage on your craft, allowing you to experiment without risk.

A more detailed description of your starting options appears on pages 06-08.

- 4. Setup to Fly:** While the back side of the disk is loading, put the keyboard overlay on your keyboard and open the Technical Supplement to the cockpit diagram. Get acquainted with the controls.

A more detailed description of the cockpit appears on pages 10-13, a more detailed description of the controls on pages 13-16.

- 5. Find the Pause:** When first learning, you'll want to pause frequently to look up information. Make sure you memorize the position of the PAUSE key!
- 6. Follow the Tutorial** starting on page 29 for your first few flights.

---

---

# I Operating Instructions

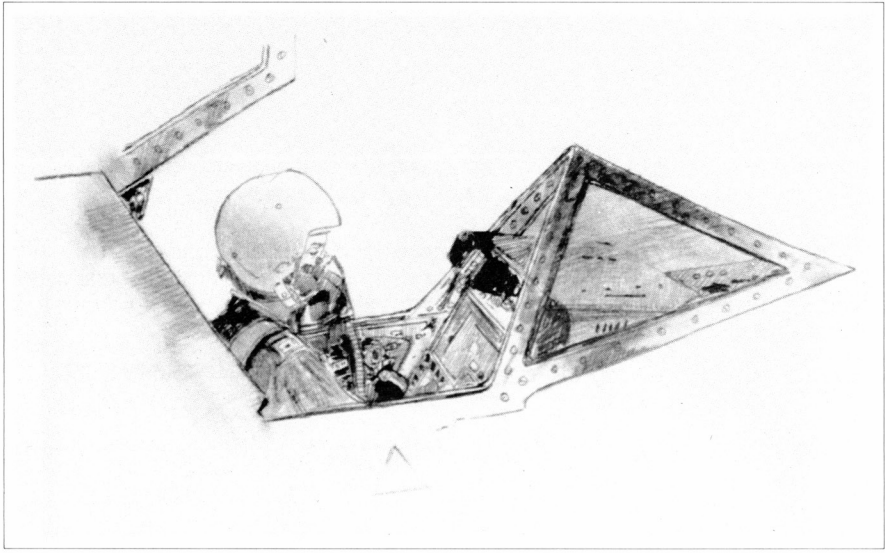

## • Preflight Briefing •

To make choices in the Preflight Briefing, move the *Controller* to highlight your choice. Then press *Selection* to make your selection. See the Technical Supplement for the location of the *Controller* and the *Selection* on your computer.

**Aircraft Identification:** To choose your own mission assignment, you must correctly identify an aircraft. Flip to the back of this manual ("Common Military Aircraft" section) and find the drawing which matches the screen illustration. Observe carefully the shape of the wings, fuselage, nose and cockpit for accurate identification. Select the correct name.

If your identification is wrong, you are automatically assigned to training. If you identification is correct, you have your choice of assignments.

**Pilot Record:** You can start a new career or continue an existing one. If you intend to save your pilot's record, you can format a blank disk before saving the record. You should not save records to your *Project: Stealth Fighter* disk. To continue, select *Begin a Mission*.

**Region of the World:** You can select one of five regions for your next mission.

*Libya Training* is a training simulator of Libya. Like all military simulators, it is only a close approximation of the "real" world. The advantage of *Libya Training* is that enemy hits do not damage to your aircraft! This allows you to experiment with new tactics without penalty. Crashing into the ground has the normal effect, depending

---

---

---

---

on what options you select.

*Libya* (the "real" world) is the least difficult of the four major regions. The *Persian Gulf* is the next least difficult. The *North Cape* and finally *Central Europe* are the most difficult regions.

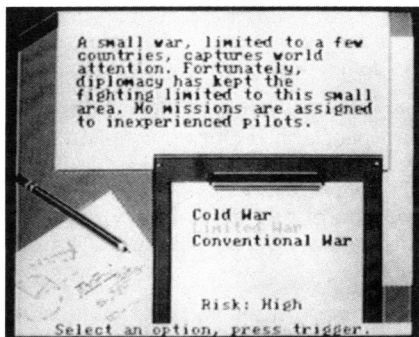

**Level of Conflict:** You can fly in an everyday *cold war* situation (the least difficult), or you can ask for a mission in a war zone. *Limited war* situations are less dangerous than *conventional war* deployments. In cold war missions you must minimize collateral damage (destruction of things other than the target) for political reasons. In limited and conventional warfare you are rewarded for additional damage.

**Type of Mission:** In "real" regions you may select the general category of mission you desire (Airborne, Tactical or Strategic targets). Your commanding officer then makes a specific mission assignment. In the *Libya Training* world you have three practice missions.

In "real" region missions, *Strike Missions* send you against surface targets on land and sea. Photo recon missions are most common in *Cold War*, fairly frequent in *Limited War*, and rare in *Conventional War*. Target destruction missions are the reverse (most common in *Conventional War*, least common in *Cold War*). "Air-Air" Missions involve intercepting and destroying a specific enemy aircraft.

In the *Libya Training*, *Bombing Practice* sends you to the Gulf of Sirte, with no active aircraft or SAM defenses, to practice weapon release runs. In *Air-Air Practice* you are sent to Benghazi, an area protected by simulated Libyan fighters. In *Dress Rehearsal* you are sent to Tripoli, an area with both SAM and aircraft defenses.

**Opponent Quality:** You can select the quality level of the enemy forces. *Green* have no tactical skill or sophistication. *Regular* opponents are faster reacting and show some tactical skill. *Veteran* opponents react with combat-honed reflexes, and will use all their battlewise experience against you.

Higher quality enemy forces will tend to have better equipment. The state of war (cold war, limited war, or conventional war) will also affect the equipment and reaction time of the enemy.

**Flight Performance:** You can select the level of F-19 flight performance you desire. The *No Crashes* option is intended for beginners who need to practice their takeoffs, landings and aerobatics. *Easy Landings*, and ultimately *Realistic Landings* are recommended, depending on your aeronautical skills.

Flight performance affects the damage you suffer from enemy gun and missile hits. *No Crashes* means each enemy hit does very little damage (but enough hits

---

---



still shoot you down!). *Easy Landings* flight performance means hits are less effective (your aircraft is sturdier). *Realistic Landings* performance means hits are fully realistic (slightly more effective than easy flight).



**Mission Briefings:** After selecting your options, you can:

*Go on Leave:* Reject all choices and restart with a new pilot.

*Select New Mission:* This retains the current pilot and region, but restarts the other selection options. Remember, another way to vary missions is to select a new type of mission category (such as air-air instead of strike surface-target missions).

*Mission Briefing:* See detailed instructions about your mission. You should write down the name and coordinates of your target for future reference. Do this now — you may not have another chance!

*Intelligence Briefing:* This instructs you on the enemies you will face.

*Arm Your Plane:* This sends you to the armament options screen. Do not select this option until you're clear on the mission. Once you start arming you can't return to the briefing room.

**Armaments:** A default armament for each bay is suggested. However, you can change armament in any bay to a new weapon by selecting a new bay, then moving the highlight pointer to select a new weapon. In addition, you can also use the keyboard to select a new bay directly. See the Technical Supplement for the keys that apply in your implementation.

For a quick introduction to your weapons, see "Basic Weapons Use" on pages 19-26. For a detailed description of each weapon, see "USAF Ordnance" on pages 55-63. To begin your mission, select "Arming Complete".



## • Controls •

### Head-Up Display (HUD)

The HUD is designed to provide the pilot with all critical flying and weapon targeting information, in a graphic format. This is projected on a wide-angle holographic clear

---

---

pane in the front of the cockpit. The pilot can look “through” the HUD display to see the situation outside his craft.

### HUD Display

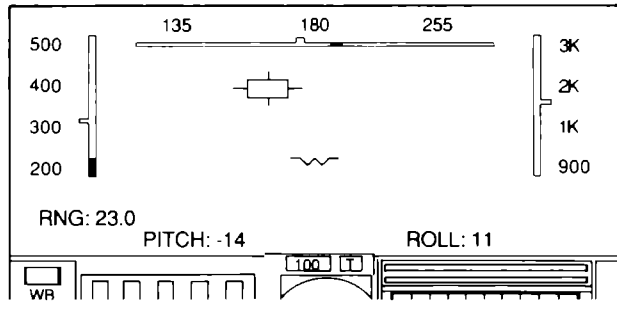

See your Technical Supplement for a detailed depiction of the HUD and cockpit.

**Airspeed:** The vertical scale on the left is your airspeed in knots. The black section of the scale represents stall speed. If your speed drops to the black range, you will lose aerodynamic control. The plane will suddenly yaw and pitch down. This can be fatal at low altitudes. Note that stall speed varies as you maneuver the plane.

**Altitude:** The vertical scale on the right is your altitude in feet, showing your altitude above sea level. At 1,000' and higher the scale changes to thousands ("2K" means 2,000' altitude, "13K" means 13,000' altitude, etc.).

**Heading:** The horizontal scale across the top is your heading in degrees. North is 000°, East is 090°, South is 180°, and West is 270°. The black mark on the scale shows the heading you should fly to reach the currently selected INS point.

**Plane Indicator:** This is a reference mark in the center of your HUD, showing what direction your nose points. The plane is geometrically level when the top of the plane indicator touches the horizon (pitch reads 0°). However, don't confuse this with *level flight*. To achieve level flight, you may need to pitch up or pitch down somewhat, depending on your throttle setting and altitude. See "Basic Flying", pg 16, and "Aerodynamics", pg 34, for details.

**Pitch:** This describes the vertical facing of the aircraft, in degrees. Positive pitch means nose up, negative pitch means nose down. For example, a pitch of 17 means the plane is angled upward 17°, while a pitch of -4 means the plane is angled downward 4°.

**Roll:** This shows left-right (port-starboard) motion around the aircraft's axis. Roll to the right (starboard) is positive, roll left (to port) is negative. For example, a roll of 45 means the plane is banked to the right 45°. A roll of -6 means the plane is banked left 6°.

**Target Box/Oval:** Your tracking system is constantly functioning, picking up potential targets within view of your HUD. A potential target is outlined by a box on the HUD.

---

---

When using guided missiles or bombs, the tracking box changes to oval when the weapon locks on. Guided weapons are very inaccurate unless locked on. If the lock-on is maintained and the range gets closer, accuracy will increase further, indicated by a the oval changing color.

**Gunsight:** When the cannon is the active weapon, the gunsight circle appears on the HUD. The gunsight shows where your shells could hit. See "Basic Weapons Use", page 19 below, for more detail. **WARNING:** Guns are only effective at ranges of 2.5 miles or less (see Range, below).

**Bombsight:** When unguided bombs are your active weapon, the bombsight appears as a line extending from the plane indicator, with a circle at the end of this line. The line represents the fall of the bomb, the center of the circle where the bomb will hit.

**135mm/IR Camera Frames:** When the 135mm/IR cameras are active and ready to use, two indicators appear at the top of the HUD. The film indicator to the left is the amount of film frames left in the camera. The frame indicator to the right is the number of good frames taken in the target area. At least 300 frames of the target are required for success.

**Range to Target:** This shows the range to the current target in miles. This figure is of vital importance with guns, since they are only effective to a 2.5 mile range. You can fire at enemies further away, but the guns won't do any damage.









## Cockpit Control Panel

Like many modern aircraft, the F-19 cockpit is dominated by multi-purpose CRT screens. Elsewhere easy-to-read bar gauges are used instead of older, hard-to-read round dials. The main cockpit display complements the information already present on the HUD.

See your Technical Supplement for a detailed depiction of the cockpit display and a list of the colors used in your implementation.

**Monochrome Text CRT:** This screen displays incoming radio messages automatically. It can be switched to show the status of your weapons status, internal

## HUD Tracking & Weapons Symbols

	Plane indicator
	Target (airborne tracking)
	Target (ground tracking)
	AAM Target (no lock-on)
	AAM Target (locked on)
	AGM or Laser Bomb Target (no lock-on)
	AGM or Laser Bomb Target (locked on)
	Bombsight for unguided bombs
	Cannon Gunsight

---

---

systems status (including damage to your plane and defenses remaining), or to identify targets.

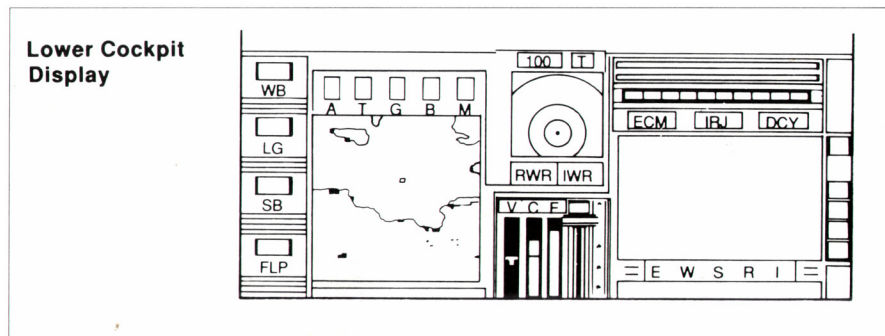

**Monochrome CRT Status Lights:** Below the Monochrome CRT are a row of status lights, showing which function is currently active on the CRT. The status lights read as follows:

- E = enemy identification being displayed
- R = radio message being displayed
- W = weapons data being displayed
- S = systems information and damage being display
- I = Inertial Navigation System (INS) Set-mode on

In addition, to the right of the CRT are weapons selection lights. These show which weapon is active.

**Color CRT:** This shows the INS (Inertial Navigation System) strategic and tactical maps. These maps are always oriented so North (000°) is to the top, East (090°) to the right, South (180°) down, and West (270°) to the left.

**EMV Bar Gauge:** This shows the current Electro-Magnetic Visibility of the F-19. The lights illuminated indicate your "visibility" to the enemy. Just one light indicates very low visibility, while all ten indicates maximum visibility. The bar gauge changes color as an additional reminder. Bar gauge colors vary with implementation, see your Technical Supplement for the latest information.

**Defenses Status Lights:** Beneath the EMV are three status lights showing the status of your defensive systems. When a light is off, that defense is inactive. When the light burns brightly the defense is active and running. When the light is dim, the jammer is off and cooling down. Only jammers (ECM and IRJ) require cooling after each use. They cannot be turned on while cooling. These lights are labelled as:

- ECM = Radar Jammer status light
- IRJ = Infrared Jammer status light
- DCY = Decoy status light

Although decoys do not require cooling, you only have a limited number of decoys. Jammers can be used any number of times.

---

---

---

---

**Threat Display:** This shows enemy radar and thermal sources. Enemy ground radars and missiles are dots of different colors. Enemy aircraft are small aircraft symbols. The aircraft symbol color changes, depending on whether the enemy plane is above or below you. See the Technical Supplement for the dot and symbol colors used on your display.

*Threat Display Scales:* The threat display has three scales; the current scale appears above the display. The largest is 100 miles, the second 25 miles, the third 12 miles. On the 100-mile scale, the inner circle represents the area seen by the 25-mile scale. On the 25-mile scale, the middle arc represents the area seen by the 12-mile scale.

**Warning Lights:** These prominent lights, below the threat display, warn of enemy radar and Infrared homing threats. The color of the light determines the level of threat.

Below is a list of conditions for the radar warning receiver. Warning light colors vary, see the Technical Supplement for details.

<i>Warning Light:</i>	<i>Typical Color:</i>	<i>Meaning:</i>
Off	Black	No enemy radar in range
Search Warning	Blue	Enemy search radar in range, has not seen you
Search Detection	Yellow	Enemy search radar has found you
Firing Warning	Red	Enemy SAM radar tracking you
Firing Detected	Flashing Red	Enemy SAM launched & flying at you

The Infrared warning receiver only shows firing detect, since IR homing missiles don't reveal themselves until they are in flight toward you.

**Throttle:** This indicator shows the current throttle position. The top position represents maximum throttle for maximum power. The bottom position represents engine idling power (virtually no power).

**Fuel Supply Bar Gauge:** This bar gauge shows the fuel supply remaining in the main tanks. When the tanks are full, the bar is solid to the top. It drops down as fuel is used. It changes color when fuel is low.

The bar gauge only shows the main fuel tanks. If the plane carries extra fuel in a weapons bay, this extra fuel is not shown until transferred to a main tank.

**Fuel Consumption Bar Gauge:** This bar gauge shows the rate fuel is being consumed. The taller the bar, the faster fuel is consumed. The throttle setting dramatically affects fuel consumption.

Fuel tank damage (leaks) increase fuel consumption. Flying at higher altitudes decreases fuel consumption.

**VVI (Vertical Velocity Indicator) Bar Gauge:** This bar gauge shows the rate of climb or descent. If the bar is invisible, you are flying level at a constant altitude. If the bar is above the middle line, you are climbing (the taller the bar, the faster the climb). If the bar is below the middle line, you are descending (the further down the bar, the faster the descent).

---

---



---

---

**Avionics Status Lights:** These lights, above the Color CRT, show the status of your avionics systems. The specific indicators are:

- A = Acceleration warning; you are flying in accelerated flight mode.
- T = Tracking Mode\*
- G = Gunsight system for cannon active on HUD
- B = Bombsight system active on HUD
- M = Missile system active on HUD

\*The color shows whether you are tracking ground or air targets. Normally ground target mode shows green, air target mode blue, but colors can vary. See the Technical Supplement for your implementation.

**Flight Controls Status Lights:** These lights show the status of your flight controls. The indicators are:

- WB = Weapon bay doors are open
- LG = Landing gear is extended (down)
- SB = Speed brake is extended (out)
- FLP = Flaps are extended (out)

## Flight Controls

The specific device or key for your flight controls varies between implementations. See your Technical Specifications for details. In addition, included is a controls overlay for your standard control configuration.

**Engines On/Off:** This switch *toggles* your jet engines on or off. You must turn on the engines before you can take off. You must turn off the engines after landing. If you run out of fuel, the engines turn off automatically.

**Control Stick:** This controls the pitch and roll of the aircraft. Stick forward pitches the nose down, stick back pitches it up. Stick right rolls the plane to the right, stick left rolls it left. Moving the stick diagonally gives both pitch and roll in the appropriate direction.

**Increase Throttle:** This increases your engine power.

**Decrease Throttle:** This reduces your engine power.

**Look Ahead:** You look out the cockpit front, viewing through the HUD.

**Look Left:** You look out the cockpit's left side.

**Look Right:** You look out the cockpit's right side.

**Speed Brakes & Gear Brakes:** In flight this *toggles* the speed brake (air brake) between extended (out) and retracted (in) position. When the speed brake is extended (indicated by the light labelled "SB") your airspeed is reduced. When the speed brake is off (retracted) the aircraft flies faster.

On the ground, this automatically activates landing gear brakes as needed. Turn the brake off when you wish to roll freely.

**Flaps Extended/Retracted:** This *toggles* your flaps between extended (out) and retracted (in) position. When the flaps are extended (indicated by the light

---

---

---

---

labelled "FLP" ) the aircraft gains lift but slows down. Stall speed is also reduced. The flaps automatically extend to the maximum position possible for the current airspeed.

**Landing Gear Up/Down:** This *toggles* your landing gear between extended (down) and retracted (up). The landing gear must be down (indicated by the light labelled "LG") for a safe landing. As a safety feature the landing gear cannot be extended at speeds over 350 knots. On the ground, pressure sensors prevent accidental retraction of the landing gear.

**INS Set-mode On/Off:** This *toggles* on/off your ability to change INS (Inertial Navigation System) waypoints. When turned on, the control stick is disconnected from flight control. Instead it controls the flashing INS navigation point on the strategic map (appearing in the Color CRT). When turned off, the control stick is reconnected to the flight controls and functions normally.

*Warning:* Do not engage the INS Set-mode in the middle of a flight maneuver, since you lose control of the aircraft while the stick is disconnected. Only engage INS Set-mode when you are in level flight.

*Default:* At the start of each mission, the INS waypoints are set to your mission objective and your destination airbase. You can leave them there or adjust them to suit your own battle plan.

**Switch INS Nav Waypoints:** Your INS system can store two different waypoints. This switch *toggles* between these waypoints. The currently active point flashes on the strategic map.

**Strategic Map:** This displays the overall regional map on the Color CRT. INS navigation waypoints and your current location also appear on this map. The currently active INS waypoint flashes on this map.

**Tactical Map:** This displays a closeup map of the local area on the Color CRT. The INS system is *not* linked to this map.

**Pilot Ejection:** This ejects you from the aircraft. The zero-zero ejection seat's optimal use is at altitudes of 2,000 to 14,000 feet with the aircraft in a moderate, level climb (pitched upward at 5° to 25° with 0° roll). The most dangerous ejections are at very low altitudes (under 500 feet), in steep dives, or when inverted.

**Accelerated Time:** This switch *toggles* on and off the rate at which time passes. When turned on (avionics "A" status light is on), time moves four times faster than normal. This helps make long flights pass quickly. This option automatically stops, sending you back to normal time, if the enemy detects your plane, you activate weapons, or your landing gear is down.

**Pause:** This *toggles* the simulation into and out of a "freeze". While frozen the simulation is halted. When released from freeze, the simulation continues.

## Combat Systems Controls

The specific device or key for your flight controls varies between implementations. See your Technical Specifications for details. In addition, included is a controls

---

---

---

---

overlay for your standard control configuration.

**Change Threat Display Scale:** This *toggles* the threat display range scale. The threat display has three scales: 100 miles, 25 miles and 12 miles.

**Switch Tracking Mode:** This *toggles* between the two tracking modes: ground and air. Note that the ground mode may not function reliably at high altitudes, while the air mode turns on your radar, increasing your EMV enormously.

*Important Note:* If you have guided missiles or laser-guided bombs active, tracking is "locked" to the appropriate mode. Switching modes is disabled until you change or turn off the weapon.

**ID Target:** This displays the name of the current tracking target on the Monochrome CRT.

**Switch Targets:** This *toggles* through all ground or all air targets on the HUD, but does not change the tracking mode. Note that you cannot switch between ground and air targets unless you switch tracking modes (see above).

**Display Weapons:** This shows on the Monochrome CRT, the weapons and ammunition currently available. If a weapon is active, the light to its right is on.

**Weapons Bay #1, #2, #3 or #4 Armed:** This opens the weapon bay doors and activates the appropriate bay. The tracking mode automatically switches to the appropriate one (ground or air) for weapons in that bay.

**Cannon Armed:** This activates guns and gunsight system. The tracking mode (ground or air targets) remains in that most recently used. If you wish to switch and track the other type of target, you must use the *Switch Tracking Mode* key. Remember, cannons have a maximum range of 2.5 miles.

**Fire/Launch/Drop Weapon:** This fires, launches or drops the currently active weapon. That is, it fires one burst from the 20mm cannon, launches one missile, or drops one bomb. If the 135mm/IR cameras are active, the cameras run while the button is held down.

**Drop Decoy:** This drops one general-purpose decoy, suitable for use against both IR and Radar-guided missiles. The decoy confuses the missile, causing it to explode harmlessly out of range.

**IR Jammer On/Off:** This *toggles* your IR jammer on and off. When running, the jammer confuses Infrared homing missiles, causing them to explode harmlessly out of range.

**Radar Jammer On/Off:** This *toggles* your radar jammer on and off. When running, the jammer confuses radar homing missiles, causing them to explode harmlessly out of range.

*Warning:* Each jammer is prone to overheating. If run too long, it will automatically turn off. Once turned off, the jammer cannot be turned on until it cools down. Use the status lights to monitor the condition of each jammer. Note that the longer a jammer runs, the longer it takes to cool down.

---

---

---

---

**Bay Doors Open/Close:** This *toggles* your weapon bay doors open or closed. Note that open doors increase your EMV.

**Weapons Shutdown:** This automatically closes the weapon bay doors and switches to ground tracking (i.e., turns off air radar). This is known as EMCON (emissions control), since all EMV-increasing weapons functions are shut down.

**Display Systems Status & Damage:** This shows, on the Monochrome CRT, the status of your aircraft and its defenses. The various systems include:

*Decoys:* This shows the number of general-purpose decoys remaining, or if the entire decoy launcher is knocked out.

*Jammers:* If your jammers are knocked out, neither the radar nor the IR jammer can function. However, your decoys are unaffected by jammer damage.

*Fire Cntl:* If your fire control computer and radar system are knocked out, you cannot fire any of your offensive weapons.

*Flgt Cntl:* If your flight controls are damaged the plane's responses are sluggish. If the damage is heavy, the plane flies erratically.

*Fuel Tank:* A damaged fuel tank will leak. The rate of leakage may be light or heavy. If the tank is leaking the fuel consumption gauge increases appropriately.

*Bay Doors:* If your weapons bay doors are jammed, they cannot move. If the doors are currently closed, all bay weapons are now ineffective (they cannot be deployed). If the doors are open, weapons can be used but your EMV is permanently higher (open doors increase your EMV) and your airspeed is slightly reduced.

---

---

## • Basic Flying •

### Takeoff

The preflight checklist for your F-19 Stealth Fighter is:

**1. Set INS System:** The standard technique for using the INS (Inertial Navigation System) is to set one point at the target, the other at your return destination. This is the default setup when you begin a mission.

If you wish to set different INS points, to guide a more complex course, then switch to the INS nav point you wish to change, then turn on the INS Set-mode and move the flashing point using the control stick. Turn off the INS Set-mode.

**2. Check Armament:** Display your weapons on the Monochrome CRT, reviewing the type and quantity of ordnance in each bay.

**3. Light Off the Engines:** Turn on your engines. Don't touch the throttle until the engines are warmed up and you're cleared for takeoff.

---

---

---

---

**4 (Sea):** If you are on an aircraft carrier, follow this procedure:

- A. Extend (open) your flaps.
- B. Increase the throttle to the maximum.
- C. Release the brakes to fire the catapult.
- D. Just before you cross the bow, pull back to pitch up in an 8° to 20° climb.
- E. Retract (close) your flaps.
- F. Retract your landing gear.
- G. Turn onto course. Avoid rolls more than 25° until airspeed passes 400 kts.

**4 (Land):** If you are on a runway, follow this procedure:

- A. Release the brakes.
- B. Increase the throttle to the maximum.
- C. When your speed reaches 200 knts, pull back in an 8° to 20° climb.
- D. Retract your landing gear.
- E. Turn onto course. Avoid rolls more than 25° until airspeed passes 400 kts.

## Flight

**Straight & Level Flight:** A good pilot must first master level flight. To do this, climb to the cruising altitude you desire (for example, 35,000 feet, or 35K on the HUD altimeter). Then level the aircraft so the HUD plane indicator is at the horizon. Next reduce the throttle until fuel consumption gauge drops to about 50% maximum (just one color shows on the strip gauge).

Although the plane indicator on the HUD may appear level with the horizon, a glance at the VVI bar gauge and HUD altimeter may show that you're gradually climbing or descending. If you're gradually climbing, push forward lightly on the Control Stick until the VVI gauge strip disappears. If you're descending pull back light on the Control Stick. Small adjustments to the throttle may be required for perfectly level flight.

This adjustment of pitch to achieve level flight is called changing your "angle of attack" (the angle at which your wings slice through the air). See "Aerodynamics & Flight", page 34, for a detailed explanation .

**Maneuvering:** As your roll angle (when turning right or left) increases beyond 45°, your stall speed rises from the normal 200 knot range to 350 knots (in a 90° roll). Since tight turns often "bleed off" airspeed, a long, tight turn can reduce your airspeed below the stall speed. Keeping an eye on the airspeed and stall speed is especially important when making tight turns at low altitude. If you're only a few hundred feet from the ground, a stall means a crash!

Loops are easy in your F-19 Stealth Fighter, but ballistic ("straight up") climbs can only be maintained for short periods, as the engines are insufficient for a prolonged ballistic climb. Both of these maneuvers can reduce your airspeed rapidly, and possibly provoke a stall. Do not attempt either unless you start with at least 500 knots of airspeed.

Above all, use a light touch on your *Control Stick*. The most common pilot error is a ham-fisted use of the stick, throwing the plane around the sky in uncontrolled abandon. While some can maneuver that way, it's virtually impossible to line-up a

---

---



---

---

weapons attack unless you maintain fine, precise control of your aircraft.

**Low Altitude Flying:** At altitudes under 750 to 800 feet you can expect increased buffets, downdrafts and other irregularities that make flying difficult. At altitudes under 350' to 400' this becomes a serious problem. The F-19 does not have terrain-following radar with automatic flight control, making control at low altitudes quite challenging.

## Straight-in Landing

*Important Warning to Experienced Pilots:* The F-19 does not use speed brakes when landing (unlike most planes). The speed brakes greatly reduce the responsiveness of the control stick at low speeds. The brakes are only used in combat, or when stopping on runways.

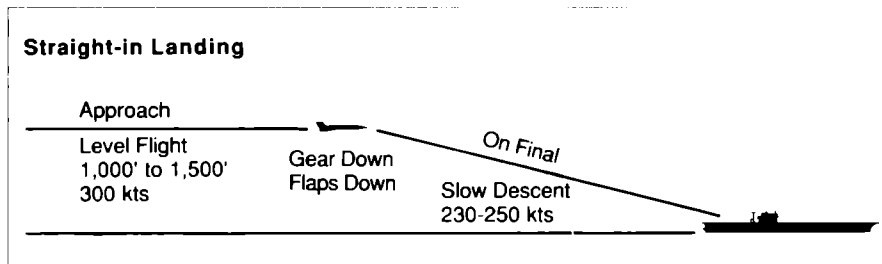

**1. The Approach:** Approach the runway or carrier at 1,000' to 1,500' altitude. Fly to a position *far* beyond the end of the runway, or the stern of the carrier, and then turn directly toward it. Runways and carriers are all oriented on a north-south axis for simplicity, so if you position yourself correctly, a course of 000° or 180° will bring you straight in. It's wise to set up your approach as far away as possible when first learning. Always approach a carrier from the south (its stern).

**2. Level Flight at 300 kts:** Now reduce your throttle until the airspeed shows 300 knots (this is about 70% of maximum). You'll need to raise the nose a little to maintain level flight. Typically a 7° pitch up is required. Your altitude should be 1,000' (1K) to 1,250' altitude. If you're too low, raise the nose a bit more to climb back to the proper altitude. If you're too high, drop the nose to descend.

**3. Gear and Flaps Down:** Next lower the landing gear and extend the flaps. This will slow the plane further, to about 230-250 knots. Now drop the nose to reduce your pitch a few degrees and reduce the power until you are at a very slight descent on the VVI strip gauge.

**4. Descend 'On Final':** You're now flying straight toward the runway or carrier stern, gradually descending. You can adjust the rate of descent by adding or subtracting a tiny bit of throttle power (the civilian technique), or by raising or dropping your nose a tiny amount (the military technique). Try to setup your descent so you cross the stern of the carrier at just under 50', or the end of the runway just under 100'.

**5. Touchdown:** You can continue your descent and touch down (the easiest

---

---

---

---

method). However, "real" pilots reduce the throttle and pull on the stick slightly to "flare" on touchdown. This scrubs extra speed and softens the landing. However, it can be tricky — novices sometimes "porpoise" or "bunny hop" down the runway because of too much stick movement!

**Runway Layout:** For simplicity, runways you will use have a north-south orientation and a center stripe down their middle. On approach your course of 000 (if coming from the south) or 180 (if coming from the north) should be aiming your directly at the runway. The runway is more than twice as long as your safe landing distance at 200 kts. You have a large safety margin.

**Carrier Deck Layout:** When landing on a carrier, you'll notice the rear deck has a slightly diagonal stripe. That line represents the "center-line" of the stern runway. You should try to land along the line. Crossing the middle of the line is the main arrestor wire. Actually, other smaller arrestor wires are also present on the deck. As long as you touch down near the arrestor wire, you'll probably be caught and held fast. However, do not attempt to land on the bow of the ship. There are no arrestor wires there, so you may roll overboard! Furthermore, arrestor wires may not work in reverse: landing from bow to stern may result in you rolling off the stern!

**Aborted Landings:** If you get in trouble landing, open the throttle to full power, then retract the flaps and landing gear. Climb away and come around for another try. Do not make wild movements with the control stick while landing or aborting. Wait until your airspeed gets up past 350 knots before making any big turns or similar maneuvers. Until then, gross maneuvers with the control stick, causing a radical change in pitch or roll, may stall the plane and cause a fatal crash.

---

## • Basic Weapons Use •

To first learn the use of each weapon, you are advised to find the correct category and follow the "by the book" instructions for that weapon. For further explanations and hints on advanced tactics, refer to the "Equipment & Tactics" section.

### Identifying Targets

Before using weapons you should check your possible targets. Switch between ground or air targets by pressing *Switch Tracking Mode*. Identify a target by pressing the *ID Target* key. If multiple targets exist on the HUD, rotate through those available (for that tracking mode) by pressing the *Switch Targets* key.

Note that tracking and identifying ground targets has no effect on your EMV, since you're using an imaging system. However, tracking and identifying aircraft targets requires the use of your radar, which greatly increases your EMV and thus your visibility to the enemy.

### Types of Weapons

The vast array of possible weaponry for your F-19 can be categorized as follows:

---

---

---



---

<i>Grouping</i>	<i>Includes these weapons:</i>
Cannon	M61A1 20mm Cannon
Air-to-air Missiles (AAMs)	AIM-9M Sidewinder AIM-120A AMRAAM
Air-to-ground Missiles (AGMs)	AGM-65E Maverick AGM-88A HARM Penguin-3 ASM AGM-85A Harpoon
Laser-guided Bombs	GBU-12 Paveway Mk 20 Rockeye II
Unguided Retarded Bombs	Durandal Mk 82-1 Snakeye Mk 20 Rockeye CBU-72 FAE ISC B-1 Minelets Mk 35 IN Cluster
Unguided Free-fall Bombs	Mk 82-0 Slick Mk 122 Fireye
Reconnaissance Camera	135mm/IR Cameras
Extra Fuel	1500 lb Extra Fuel Tank

Each of these weapons is only effective against certain types of targets. In addition, most weapons are only effective if launched at certain altitudes. Otherwise they miss (the hit is a dud). If you score a successful hit, but use the wrong type of weapon, you are informed of an "Ineffective Hit".

## Firing 20mm Cannons

**In Principle:** Cannon range is 2.5 miles. When activated, the cannon gunsight appears on your HUD. This sight shows where your shells would be exploding, now, if you had fired at the correct instant in the past (usually a bit over one second ago). Since it takes about one second for shells to travel 2.5 miles, every time you fire, you're guessing where the sight will be about a second from now, because that's where the shells will hit.

Cannons can be fired at air or ground targets. Simply select the appropriate tracking mode (press *Switch Tracking Mode*). When firing against ground targets, the common error is to fire at targets too far away.

**In Practice:** The standard engagement procedure for using the M61A1 20mm cannon is:

1. Maneuver your plane so the target is ahead of you, visible on the HUD.
  2. Switch tracking mode to air or ground, depending on the target. The target is enclosed by a rectangular box. Then ID the target ("just to be sure").
  3. Activate cannon armament and your circular gunsight appears on the HUD.
  4. The cannon has a maximum range of 2.5 miles. Firing at targets beyond this
- 
-

### Firing 20mm Cannon

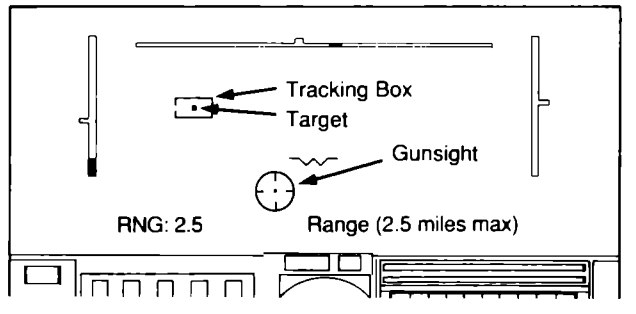

range is a waste of ammunition.

5. As the target and your gunsight move together, fire a burst about one (1) second *before* the sights intersect. If you have guessed correctly, the shells will arrive just as the sight crosses the target. Shells that hit show brightly colored explosions, shells that miss show dark smudges of smoke.

Enemy fighter aircraft cannot survive more than one or two cannon bursts, but larger enemy aircraft may require numerous bursts for a kill. Almost all ground targets must be hit by multiple bursts before they are destroyed.

6. When finished, turn off the weapon system and return to EMCON (maximum stealth) configuration.

### Firing Air-to-Air Missiles (AAMs)

**In Principle:** Both AAMs available are "fire and forget" types. Switch your tracking mode to air targets, ID the target, then activate your weapon. While the target box remains rectangular missile accuracy is very poor. When it changes to an oval (missiles is "locked on") accuracy is reasonably good. If you wait longer, the oval changes color, indicating an even better accuracy. The highest possible accuracy occurs by waiting as long as possible after the oval changes color.

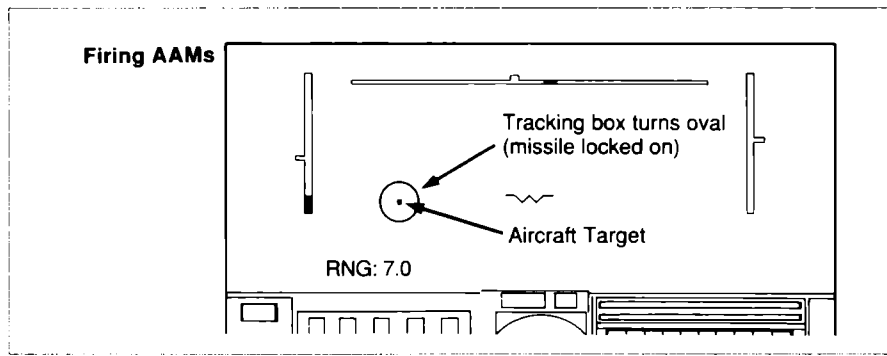

---

---

Neither the Sidewinder nor the AMRAAM are effective against ground targets.

**In Practice:** The standard target engagement procedure for using either AIM-9M Sidewinder or AIM-120A AMRAAM air-to-air missiles is:

1. Identify the aircraft target on the threat display.
2. Maneuver your plane so the target is ahead of you (directly above the center of the threat display).
3. Switch your tracking mode to air targets. A box appears around an enemy plane on the HUD. If it doesn't, the enemy may be above or below you, maneuver accordingly. If multiple enemies are present switch between targets until the box is around the target you wish to destroy.
4. Display weapons on Monochrome CRT and activate the weapons bay containing appropriate air-to-air missile. AMRAAM missiles are advised at ranges over 10.0 miles, Sidewinders at ranges under 10.0 miles.
5. Wait for the target box to turn oval. This indicates missile accuracy is good. If you wait, the oval changes color, indicating higher accuracy. You can still wait, to the last minute, for absolute maximum accuracy.
6. After releasing the weapon, you may maneuver freely. You should turn off your weapons system and return to EMCON (maximum stealth) configuration. The results of your attack will appear on the Monochrome CRT.

### **Firing Air-to-Ground Missiles (AGMs)**

**In Principle:** AGMs also are "fire and forget" weapons. Switch your tracking mode to ground targets, ID the target, then activate your weapon. While the target box remains rectangular missile accuracy is very poor. When it changes to an oval (missiles is "locked on") accuracy is reasonably good. If you wait longer, the oval changes color, indicating an even better accuracy. The highest possible accuracy occurs by waiting as long as possible after the oval changes color.

Missiles can be released at any altitude between 300' and 30,000'. The only exception is the HARM, which is ineffective if released below 1,000' altitude.

*HARM* missiles are excellent against any enemy radar.

*Maverick* missiles are good against armored land radars, headquarters bunkers and armored vehicles (such as the armored fighting vehicle (AFV) SA-8, -9, -11 or -13). They are NOT effective against normal buildings and simple missile emplacements.

*Penguin* and *Harpoon* missiles are designed to sink warships. The Harpoon is heavier, but is harder to stop and has longer range (see USAF Ordnance, pages 55-63, for details).

**In Practice:** The standard target engagement procedure for using any guided air-to-ground missiles (HARM, Maverick, Penguin, or Harpoon) is:

1. Identify the target on the threat display (if it has radar), or visually (the tactical
- 
-



---

---

## Firing AGMs or Dropping Laser-Guided Bombs

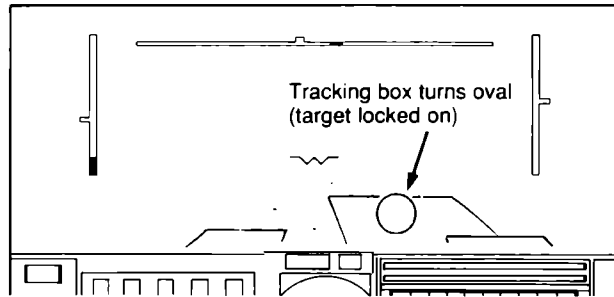

navigation map can be a useful aid).

2. Maneuver your plane so the target is ahead of you, visible through your HUD. Switch to ground target tracking and select ID target. If multiple targets exist, switch between them to find your target.
3. Display weapons on the Monochrome CRT. Activate the weapons bay containing the appropriate missile.
4. Make sure your altitude is between 300' and 30,000'; firing outside these limits may cause the missile to miss. HARM missiles should not be launched under 1,000' of altitude.
5. Wait for the target box to turn oval. This indicates missile accuracy is good. If you wait, the oval changes color, indicating higher accuracy. You can still wait, to the last minute, for absolute maximum accuracy.
6. After releasing the weapon, you may maneuver freely. You should turn off your weapons system and return to EMCON (maximum stealth) configuration. The results of your attack will appear on the Monochrome CRT.

## Dropping Laser-Guided Bombs

**In Principle:** Laser-guided bombs are dropped like guided missiles. You must release at an altitude between 500 and 2,000'. However, their lock-on range is very short (since the bomb glides to target without power). After releasing the bomb you must maintain the laser guidance of the bomb. You do this by not pitching or rolling more than 60° until the bomb hits the ground.

*GBU-12 Paveway* bombs are excellent against buildings, bunkers, and armored vehicles of all types (including SA-8,-9,-11 and -13).

*Mk 20 Rockeye II* cluster bombs are excellent against radar installations of all types, normal buildings, and simple missile emplacements.

**In Practice:** The standard target engagement procedure for using any laser-guided bombs (*Paveway* or *Rockeye II*) is:

---

---

1. Locate the target either using your threat display (if the target has radar), or visually (the tactical navigation map can be useful).
2. Maneuver your plane so the target is ahead of you, visible through your HUD. Switch to ground target tracking and select ID target. If multiple targets exist, switch between them to find your target.
3. Display weapons on the Monochrome CRT. Activate the weapons bay containing the appropriate weapon.
4. Make sure your altitude is between 500' and 2,000'; launching outside these limits may cause a miss.
5. Wait for the target box to turn oval. This indicates missile accuracy is good. If you wait, the oval changes color, indicating higher accuracy. You can still wait, to the last minute, for absolute maximum accuracy.
6. After releasing the weapon, do not pitch up or down more than  $\pm 60^\circ$ , and do not roll more than  $\pm 60^\circ$  until the weapon lands. Otherwise the laser guidance may be disturbed.
7. When finished turn off your weapons system and return to EMCON (maximum stealth) configuration. The results of your attack will appear on the Monochrome CRT.

## Dropping Unguided Bombs (Retarded or Free-fall)

**In Principle:** Place the center of the circular bombsight on the target and release. The bombs will fall along the line indicated on the sight and land at the center of the circle. Free-fall bombs must be released between 2,000' and 8,000', retarded bombs must be released between 500' and 2,000'.

Different bombs have different capabilities, see the USAF Ordnance section for details, or follow the recommendations for your mission. The bombsight only functions below 8,000' (above that altitude its accuracy is quite poor).

**In Practice:** The standard target engagement procedure is used for any unguided ("iron") bombs. It applies to both retarded and free-fall bombs.

### Dropping Unguided Bombs

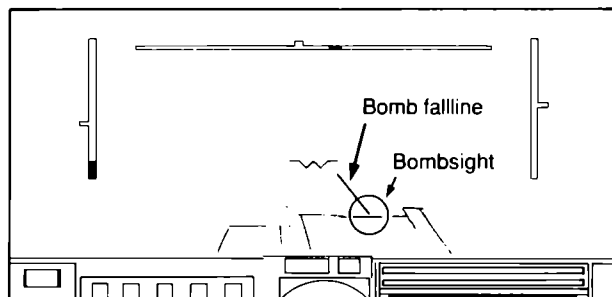

1. Identify the target on threat display (if it has radar), or visually (the tactical navigation map can be a useful aid).
2. Maneuver your plane so the target is ahead of you, visible through your HUD. Switch to ground target tracking and select ID target. If multiple targets exist, switch between them to find your target.
3. Display weapons on the Monochrome CRT. Activate the weapons bay containing the appropriate weapon.
4. Fly at 500' to 2000' over the target if using retarded bombs, or 2,000' to 8,000' if using free-fall bombs. As you fly, keep the "fall line" (line on the HUD from the plane indicator to the circular bombsight) on the target.
5. When the HUD bombsight circle is on the target, release the bomb. Various bombing techniques can be used to improve sighting and bomb placement, see USAF Ordnance section for details.
6. After releasing the bomb you may maneuver freely with one restriction: do not dive below minimum release altitude before the weapon hits. Release altitude is your safe fly-over altitude. Flying lower may cause damage to your aircraft.
7. When firing is completed, turn off your weapons systems and return to EMCON (maximum stealth) configuration. The results of your attack will appear on the Monochrome CRT.

## Using the Reconnaissance Cameras

**In Principle:** Fly level over the target area between 20,000' and 24,000'. When you are in the target area, a message appears on your monochrome CRT. Activate your 135mm/IR cameras and expose film by holding down the *Fire Weapons* button. You need to expose at least 300 frames over the target.

**In Practice:** The standard photo recon overflight procedure is:

1. Identify the target visually (using strategic and tactical navigation maps), or for the rare enemy using radar, on the threat display.
2. Maneuver your plane so the target is ahead of you.

Using Cameras

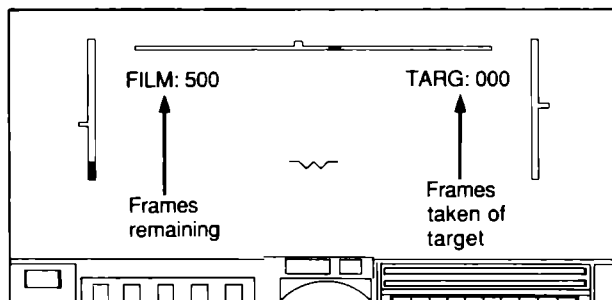

---

---

3. Fly so you'll pass over the target at 20,000' to 24,000' altitude. This means the target will be invisible below as you fly over.

4. As you approach the target, display weapons on the Monochrome CRT. Activate weapon bay containing the 135mm/IR cameras. This opens the bay door, but does NOT turn on the camera. It displays, on the HUD, film frames remaining (upper left) and frames taken over target (upper right).

5. As you overfly the target area, a message to that effect appears on the Monochrome CRT. Make sure that both your roll and pitch are 20° or less as you fly over the target.

6. Hold down the *Fire* button to run the cameras. Release the button as soon as you stop flying over the target (message disappears). This avoids wasting film.

7. When photography is complete, close the weapon bay doors. You are free to maneuver as desired.

## Using Extra Fuel

When you select an extra fuel tank, this automatically transfers the tank's fuel to your main tank.

## Hits & Misses

You will see reports on whether you weapon hit or missed the target. Note that misses can be caused by launching a weapon at the wrong altitude, as well as normal inaccuracy.

An *ineffective hit* is a weapon that strikes the target, but fails to do damage because you selected the wrong type of weapon. The briefings about each region later in this manual list each type of target you could encounter, and the weapons effective against each.

---

---

## • Postflight Debriefing •

### Ending a Mission

**Safe Landings:** When you land, stop, and shut down your engine the mission is over. Once you land, you *cannot* refuel or rearm to continue the mission. All stealth missions are costly, carefully planned "one shot" special flights. If a mission fails, higher-ups will decide later whether to try again, and if so, when, where and how. You may even get the same mission again some day!

**Crashes:** If you are using easy or realistic flight, crashing the aircraft ends the mission. It also ends your career. To remain alive, you must eject before the plane crashes.

**Bailing Out:** Safe ejection occurs between 2,000' and 14,000' altitude with the plane in a gentle climb. Ejecting outside of these limits, especially from a plane

---

---

under 2,000' altitude, may cripple or kill you.

Where you eject also is important. Ejecting over water, away from an enemy coastline, is the ideal location. You can be rescued and the aircraft sinks out of sight. The next best location is over friendly territory. Again, you can be rescued, but fragments of the wreckage could be found by the public or enemy spies. Bailing out over enemy territory is the worst option. You will probably be captured, and fragments of the wreckage will certainly be found by the enemy, helping them learn the secrets of American stealth technology. Furthermore, if you are captured, you may suffer a public trial and other humiliations before the Air Force manages an exchange to get you back again.

## Promotions, Decorations and Your Reputation

After a mission you are debriefed. Although theoretically confidential, debriefings have a habit of becoming squadron gossip. Based on your performance, your commander will make numerical ratings in your file.

**Ratings:** Your commander always is pleased when you accomplish the mission. All else is secondary. If you perform the mission and get the plane home safely (more or less) he'll be happy. How much incidental destruction and mayhem you performed (good or bad) is *always* of lesser importance.

*In Cold War* situations, you get little credit for other targets destroyed. Public opinion and the striped-pants "embassy set" don't favor gratuitous violence and indiscriminate mayhem. It makes America look bad. Sometimes you may need to destroy a SAM here or enemy fighter there. Maybe it's silly that destroying one target is OK, while destroying another causes trouble, but that's part of the job during "peacetime".

*In Limited and Conventional War* situations, you are rewarded for additional enemy ground and air targets destroyed. However, these rewards almost never compensate for failing to achieve your assigned mission. Always seek to perform the mission first. Additional destruction of enemy equipment is purely secondary.

**Stealth Percentage:** Your flight recorder maintains a record of all enemy radar signals received, and their strength. This is translated into a "stealth percentage". The higher your percentage, the more successful you were in using the stealth technology of your aircraft. The lower the percentage, the more you were seen by the enemy. A high percentage means that either you had an easy mission, or you're a very good pilot.

**Decorations:** If your rating on a single mission is extremely high, your commander may recommend you for a decoration. Since your missions are invariably secret, getting formal recognition through decorations is rare, but it can occur for exceptional heroism. The five possible decorations, from easiest to most difficult to achieve, are:

AM	Airman's Medal, recognizing good performance
BS	Bronze Star for Valor, for valor in combat
SS	Silver Star for Valor, for heroism in combat
DFC	Distinguished Flying Cross, for extreme heroism

---

---

---

---

CMOH Congressional Medal of Honor, America's highest military decoration.

**Promotions:** Your starting rank is 2nd Lieutenant. If your average performance (per mission) is good, and your rating has a sufficiently high average, you are promoted to the next rank. Ranks, from lowest to highest, are:

2nd Lt	Second Lieutenant (lowest)
1st Lt	First Lieutenant
Capt	Captain
Maj	Major
Lt.Col	Lieutenant Colonel
Col	Colonel
B.Gen	Brigadier General (highest)

Promotion from 2nd to 1st Lieutenant requires some success and at least two missions experience. Promotion to Captain requires a better record and at least five missions total experience. After that promotions require an improving record and increasing amounts of experience. After 99 missions you're asked to retire from front-line flying. But if you're a colonel with an excellent record, you could be promoted to Brigadier General the final and highest possible rank. Very few pilots survive to 99 missions, much less have a record good enough get to General. Getting a general's star with every possible decoration should be your ultimate objective.

Officers frequently forget that their *entire* record is considered when it's time for promotion. A few bad missions can affect your record by lowering the average. In active fighter squadrons, most pilots are First Lieutenants and Captains. Majors serve as flight leaders, Lieutenant Colonels as higher squadron officers or commanders, and full Colonels as squadron or wing commanders. Promotion to Major or above is very difficult. Above all, be patient about promotions. Don't expect a promotion after every successful mission (life just *isn't* like that!).

**Comparing Records:** In the Officer's Club ("O-club") bar, a flier's reputation is based primarily on how many missions he's flown. A 50-mission veteran has much greater prestige than a 3-mission greenhorn. Veterans of similar seniority may sometimes compare ratings, but nobody worries much about ranks or medals: as a fighter pilot, you're already a member of a very exclusive club.

## **Saving Your Record & Ending the Simulation**

To save your current pilot's record, continue past the scene in the officer's club bar. You'll return to the starting options, including the option to save your pilot. Do so. Once you have saved the pilot, you can begin another mission or turn off the simulation.

No fighter pilot is expected to fly more than 99 missions. After your 99th mission, you'll be requested to retire to either a nice desk job in Washington or a civilian job. The Air Force doesn't want pilots to keep flying until they're KIA — Killed In Action, the fate of all too many wartime pilots.

---

---

## II Tutorial

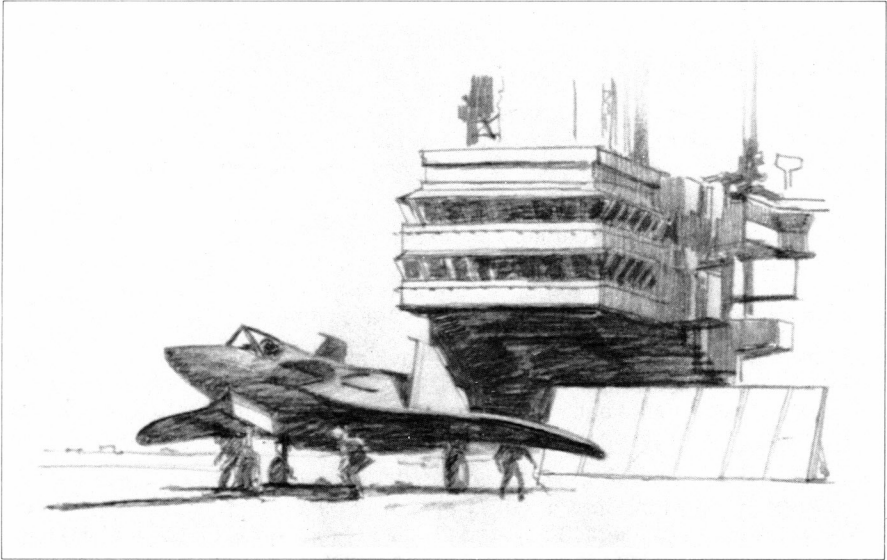

### • Training for a Libya Mission •

This tutorial helps you fly Bombing Practice when in Libya Training. First see your Technical Supplement for how to load the disk. Then correctly identify the Aircraft shown by referring to the "Common Military Aircraft" section in the rear of this manual (pages 85-110).

Next either start a new pilot, or recall an existing one (if you have one already saved). Then select the following options: *Begin a Mission; Libya Training; Limited War; Bombing Practice; Green Opponents; No Crashes; Mission Briefing; Arm Your Plane; Arming Complete.*

You should be familiar with the cockpit and controls of your plane. Open the Technical Supplement to the cockpit diagram. Place the overlay on your keyboard. If the cockpit or controls confuse you, refer to "Flight Controls" (pgs 13-14).

You'll want to fly as you read the tutorial. The best method is to read a paragraph or two, fly a little, then tap the *pause* key and read on. If things go badly just start again.

*A Note About Controls:* The placement of controls varies from one implementation to another. Consult the Technical Supplement and keyboard overlay for control locations.

---

---

**A Note About Enemy Fire:** The Libya Training scenario is only a simulation. Although enemy missiles and guns fire realistically and appear to hit your craft, they do no damage. However, you can still crash into the ground if you have selected easy or realistic flight instead of the “no crash”.

## Planning the Mission

**Familiarize Yourself:** Flip to page 66 in this manual and skim the information about Libya Training. It's especially important to locate Ras Lanuf (ONC coordinates UC82) on the map of Libya, since your mission is to bomb targets there!

Now take a minute to plan your mission. In this tutorial, your plan will be a straight-in attack from your aircraft carrier to the target, then straight out again. You'll fly at 35,000 feet until you reach the strike area, then dive to 1,250' altitude and use your Snakeye retarded bombs against the central oil terminal.

**Set the INS:** Check your INS (Inertial Navigation System) by activating the Strategic Map (press *Strategic Map* key). Now press the *Switch INS Nav Points* key to see the location of each INS waypoint, which flash in turn. These waypoints should be at your target and your return destination.

If they are not, turn on the INS Set-mode [*INS Set-mode On/Off* key] and move the flashing dot [using the *Control Stick*] on the strategic map to the appropriate location. Then turn off the INS set-mode [*INS Set-mode On/Off* key]. Make sure the currently flashing navigation point is at the target [if not, press *Switch INS Nav Points* key until the active INS point is at Ras Lanuf].

The currently flashing INS waypoint is linked to your HUD display. You'll notice a black mark on the HUD heading indicator (across the top of the HUD). If you turn the plane until this black mark is under the center tic on the indicator, you are flying toward the flashing dot (INS waypoint).

**Weapons Checkout:** Next bring up the weapon display [*Display Weapons* key] to remind you which weapons are in which bays. You should see:

- Bay #1: four Sidewinder air-to-air missiles
- Bay #2: two Maverick air-to-ground missiles
- Bay #3: three Snakeye retarded bombs
- Bay #4: three Slick free-fall bombs

If you turn on your weapons now, just to check them out, be sure to turn them off again [press *Weapons Shutdown* key]. Takeoffs with armed weapons can be very dangerous. Furthermore, active weapons can increase your EMV. To be “stealthy” you must maintain a low EMV.

## Takeoff from the CV America

Turn on your engines [*Engines On/Off* key]. While waiting for them to warm up and get takeoff clearance, extend your flaps [*Flaps Extended/Retracted* key]. Once you have takeoff clearance, increase the throttle to maximum [hold down *Increase Throttle* key until indicator reaches the top]. To launch your plane, release the

---

---



---

---

brakes [*Speed Brakes & Gear Brakes* key] which also fires the catapult.

As your airspeed rises above stall speed (i.e., moves out of the black range on the airspeed gauge), pull back gently on the *control stick* until you are climbing with 8 to 12° pitch up. Now retract the flaps [*Flaps Extended/Retracted* key] and retract your landing gear [*Landing Gear Up/Down* key]. You're airborne.

When your airspeed exceeds 400 knots, it's time to turn and get on course. For simplicity, we'll keep the plane at full throttle, but as you gain experience, you may wish to reduce the throttle now, to begin saving fuel.

Now you're flying due north on course 000 (your carrier was sailing north and you just launched from the carrier's bow). Pull back until pitch is 21°, then roll right [move the *control stick* to the right] into a 45° bank. Center the *control stick* so the plane remains stable with 21° pitch and 45° roll. Watch the heading indicator on the HUD. When black mark moves beneath the vertical tic mark (on the center of the heading line) you are on-course to Ras Lanuf. Move the *control stick* to the left, banking left until the roll is 0° again. You're now flying straight ahead. If you INS is set correctly, you should be heading about 170° (between 135 and 180 on the HUD).

However, you're still climbing. When you reach 35,000' (35K on the HUD altimeter) drop the nose and level out. Next cut back your throttle a few notches until the fuel consumption rate (the "C" strip gauge beneath the threat display) is half maximum. Your airspeed should be 500 to 550 knots.

Now it's time to achieve level flight. You're flying level when nothing shows on the VVI gauge ("V" strip gauge beneath the threat display). You may need to nose up or down a bit, so the pitch reads 1° or -1°, and/or adjust the throttle slightly, to achieve this goal.

Normally you'd just leave the plane like this and fly to your target. On a lengthy flight you can use the *accelerated time* key to reach the action faster.

However, on this practice flight, you may wish to experiment with speed and pitch. Notice that from level flight, increasing the throttle causes you to climb, and that you must drop the nose a bit to compensate. Similarly, decreasing the throttle causes you to descend, requiring you to raise the nose a bit. The lesson is simple: a pitch of zero does not necessarily mean level flight. If you're interested in the reason why, turn to Aerodynamics on page 35-36. You may also wish to experiment with opening and closing your speed brakes too.

## Approaching Ras Lanuf

Soon your radar warning receiver (RWR) will pick up incoming radar signals. The RWR light turns on dimly when you pick up weak signals that can't reveal your location. Consult the Technical Reference for the different RWR colors.

**Minimizing Your EMV:** Now that the enemy radar is awake, you must watch your own EMV carefully. A glance at that gauge should show you at level three (with three lights showing). This is pretty good, but if you gradually decrease the throttle [*Decrease Throttle* key], you can reduce it to level two. However, you'll

---

---

---

---

have to raise the nose to maintain lift. Otherwise the reduced speed will cause a descent (which is not good because your EMV rises if you drop below 32,000').

As you approach closer, enemy radar sites become visible at the top of your threat display. Each active airfield radar and SAM radar appears as a dot. Turn on your tactical map to see a detail of the Libyan coastline. When Ras Lanuf is completely in view on the tactical map, it's time to start your attack run.

## The Attack

Begin your attack by making sure your tracking system is on ground targets (the "T" light should show ground tracking color, if not, press the *Switch Tracking Mode*. Next switch your Monochrome CRT to enemy target ID mode [press *Target ID*].

Now increase the throttle to maximum and dive to 2,000' altitude. As you dive past 20,000', rotate through the various targets [press the *Switch Targets* key] to get a feeling for enemy positions. You may want to turn left and right to bring more targets into view. You may find it useful to extend your speed brakes [*Speed Brakes* key] to give you more time to view targets and grasp the situation.

At Ras Lanuf your target is the oil terminal along the coast. Activate your Snakeye bombs [press *Weapons Bay #3 Armed* key]. If your dive is still steep, the bombsight may be off the HUD. Try to level out just under 2,000' and open your speed brakes [press the *Speed Brakes* key] if they aren't already open.

As the round oil tanks of the terminal come toward you, go into a very shallow dive. Do not dive below 500', otherwise the bombs won't arm correctly. When the center of the bombsight circle crosses the oil tanks, press the *Fire* button to release a bomb. If you released the bomb on target, at an altitude between 500' and 2,000', you should be rewarded with an explosion and appropriate radio message shortly. Your mission is accomplished!

**Additional Targets:** For practice, you may wish to turn and come overhead again and again, dropping other bombs. Your *Mk 82-0 Slick* bombs should be dropped from a 2,000' to 8,000' altitude. The usual technique is to start at 10,000', nose down to a pitch of -40° to -60° pitch with speed brakes out, and release about 5,000'. Level out immediately after release.

Your *Maverick* missiles are aimed by activating the weapon and waiting until the target box turns oval. That indicates good missile accuracy. If you're brave, wait until the oval turns color, since that indicates better accuracy. For the best accuracy, you can wait a few seconds longer.

Should enemy planes appear, you'll see them on the threat display first. To engage them with missiles, arm your Sidewinders. These air-to-air missiles operate like the *Maverick*, complete with square and oval targeting box. Note that tracking air targets turns on your radar, greatly increasing your EMV (visibility to the enemy) .

## The Return Flight

To return, switch to the other INS navigation point — the one over your own aircraft carrier [use the *Switch INS Nav Points* key]. Using the HUD heading indicator as

---

---

---

---

reference, turn to the proper course (usually in a vicinity of 270° to 315°). Shut down your weapons [press *Weapons Shutdown* key] and cut back the throttle until the fuel consumption gauge shows half maximum. If your fuel level is low, nose up to a pitch 20° or more and climb back to 35,000' altitude for maximum fuel efficiency.

**Landing on the Aircraft Carrier:** The carrier is steaming from south to north. You land by crossing its stern and touching down on the rear area of its deck.

Approach the carrier from the south. As soon as you can see it on the tactical map [press *Tactical Map* key], quickly get to 1,000' altitude. Do not get too close to the carrier. If you do, circle around and try again.

Now reduce your throttle until the airspeed shows 300 knots (this is about 70% of maximum). You'll need to nose up to maintain level flight at 1,000'. Typically a 7° pitch is required.

When the carrier's deck is visible as a shape, lower the landing gear and extend the flaps. This will slow the plane further, to about 230-250 knots. Now reduce the pitch a few degrees and reduce the thrust until a very slight descent shows on the VVI gauge.

You're now flying straight at the carrier's stern, gradually descending. You can control the descent by adding or subtracting a tiny bit of throttle. You want to come over the stern of the carrier at just under 50'. Don't descend too fast, you'll end up taking a bath in the carrier's wake.

Continue your descent and try to touch down on the main arrestor wire, which runs across the deck in front of you. There are other, less visible wires so if you touch down a bit ahead or behind you'll still stop.

After touchdown, reduce the throttle to idle and turn off the engines. Mission accomplished!

---

---

## III Equipment & Tactics

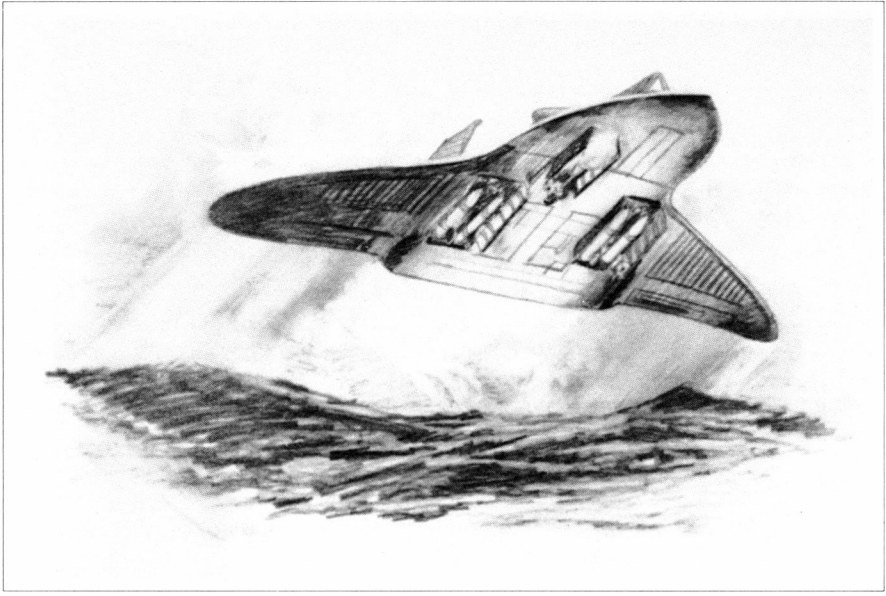

### • Aerodynamics and Flying Technique •

This discussion of lift and flight is not rigorous or precise in a scientific sense. It only provides a rudimentary portrayal of the physics of flight and its practical effect on aircraft handling.

#### The Four Forces

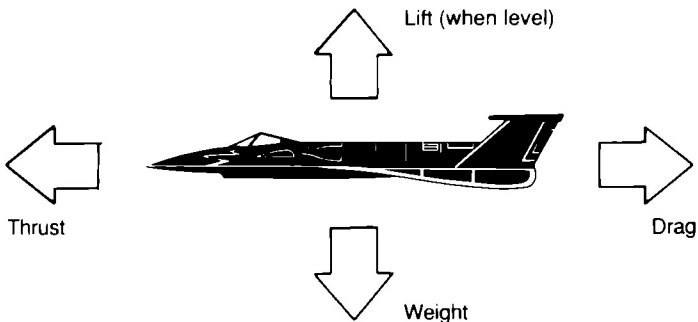

---

---

## Lift

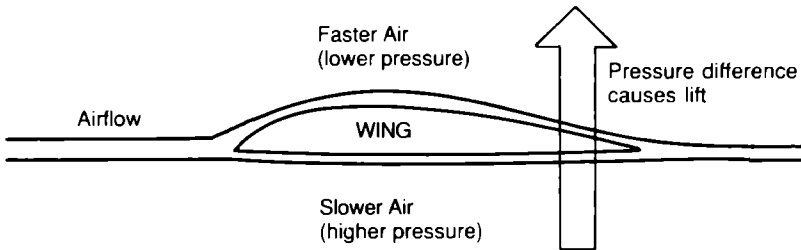

## Basic Forces

**Lift:** Aircraft fly because of a pressure difference as air flows over and under the wing. The wing design and airflow result in air moving faster over the top than over the bottom. This causes high pressure beneath the wing and low pressure above it. The wing is pushed upward, providing lift. If the pressure difference is great enough, the upward lift is greater than the plane's weight (which gravity pulls downward), and the aircraft flies.

Aircraft in flight have four basic forces acting on them. Thrust pushes the plane forward; it varies with engine power. Drag reduces the effect of thrust, but is relatively constant. Therefore, when horizontal, more thrust means faster forward velocity. Gravity pulls the plane toward the ground, regardless of the plane's attitude. Lift pushes upward from the wings, directly opposing gravity when the wings are level.

## How Lift Varies

**Speed & Lift:** The amount of lift generated by the wing varies with airspeed. The faster the plane flies, the faster the air flows, and the greater the pressure difference. If your plane is in level flight at a certain speed, reducing the speed reduces lift, causing a descent (even though you didn't nose down).

**Angle of Attack & Lift:** The amount of lift generated also varies with the angle between the wings and the airflow. If you pitch up a few degrees, you increase the pressure difference across the wing, increasing the lift. If you pitch down the nose, the reverse occurs. This difference between the airflow direction and a line through the wing (the wing "chord") is the "angle of attack" (AoA).

To achieve "level" flight at a given power setting, a pilot raises or lowers the nose until the VVI shows zero (i.e., no ascent or descent appears on the "V" strip gauge). Note that a pitch of  $0^\circ$  may show ascent or descent. Nosing up or down to a new "angle of attack" adds or subtracts lift to achieve level flight. *Never* assume that a pitch of zero automatically means level flight. Chances are it doesn't!

---

---

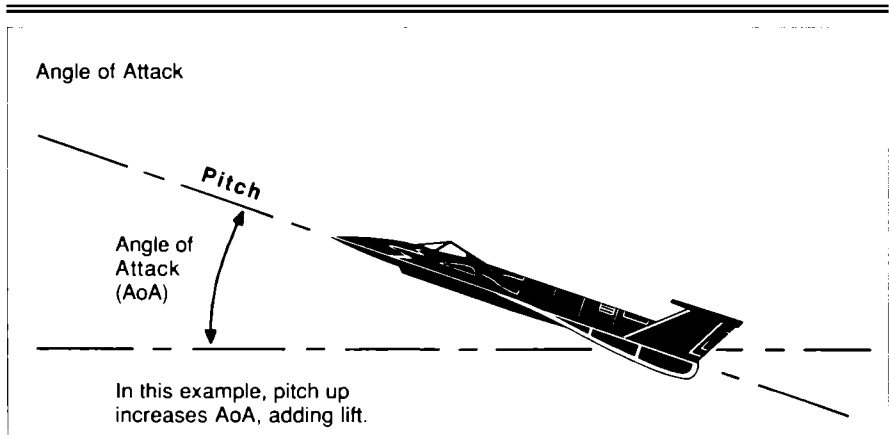

To achieve "level" flight at a specific airspeed, the pilot first gets into level flight, next adjusts his throttle to achieve the desired speed, then adjusts his nose to find level flight for the new airspeed.

## The Effect of Roll

Lift is a force perpendicular to the wing. If the wings are tilted (aircraft rolling or banking) the lifting force is no longer straight up. Instead it has two components, one moving the aircraft sideways, the other straight up. This causes the plane to

### Effect of Roll on Lift

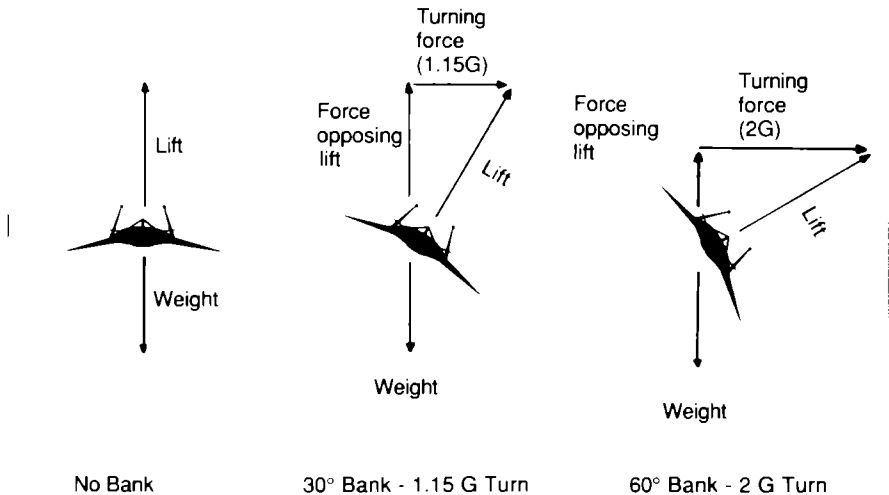

---

---

turn. However, it also reduces your lift.

As the bank increases, more and more force is needed to keep the plane flying level, since a smaller and smaller part of the force counteracts gravity. This force is measured in Gs, and is the reason pilots are pressed into their seats during a tight turn. Normal gravity and weight, standing on earth, is 1G. Pilots normally cannot survive more than 7Gs (any more and they black out, losing control and crashing).

Fine adjustments to angle of attack during turns can be achieved by trim and control stick backpressure. To simplify the job of piloting the F-19, this occurs automatically.

## Special Situations

**Stalls:** An aerodynamic stall occurs when the wing's angle of attack becomes too large. The air stops flowing smoothly over the wing, and instead part breaks away onto an independent path. This erases the pressure difference, vastly reduces lift, and generally causes the nose to drop. Stall speed varies considerably depending on aircraft attitude, flaps configuration, etc. A high stall speed (which occurs in tight turns) can be dangerous, since turns decrease your speed. It is quite possible that turns, climbs or damage may reduce your airspeed to the point where a tight turn causes a stall.

Some versions of the F-19 have an audible stall warning horn. All versions show a stall range on the HUD's airspeed indicator.

The F-19 includes an automatic computerized stall recovery governor that instantly reconfigures the wing edges for recovery, making your job much easier. To recover from a stall, first level the wings, then bring the pitch back to normal. A stall invariably costs you altitude, so a stall at low altitude is often fatal.

**Flaps:** Lowering flaps extends the wing surface and increases the pressure difference, adding more lift. They also increase drag, which lowers your speed. However, flaps are only useful at low speeds (under 350 knots).

## Military Landings

The "straight-in" landing technique described in the Operation Instructions (page 18) is used by Air Force pilots who are wounded or are flying damaged aircraft. Military pilots normally use a 360° Overhead Pattern for maximum speed and efficiency. Pilots who fancy themselves "real Air Force men" should use real military landings, not straight-in landings.

**Initial:** Start your "initial" at 400 knots, a slight pitch up (usually just 1°), at 1,500' to 2,000' altitude. Adjust your throttle to this speed, and then nose up (use a greater angle of attack) to maintain level flight. Approach the runway in the direction you wish to land, with the runway sliding beneath you.

**Pitch Out:** As the runway slides beneath you to the right, begin the "pitch out" turn by banking gradually to a 45 to 60° roll (a left bank is preferred by many pilots). This will be a full 180° turn. Your speed should drop to about 300 knots while in the

---

---

## Military 360° Overhead Pattern

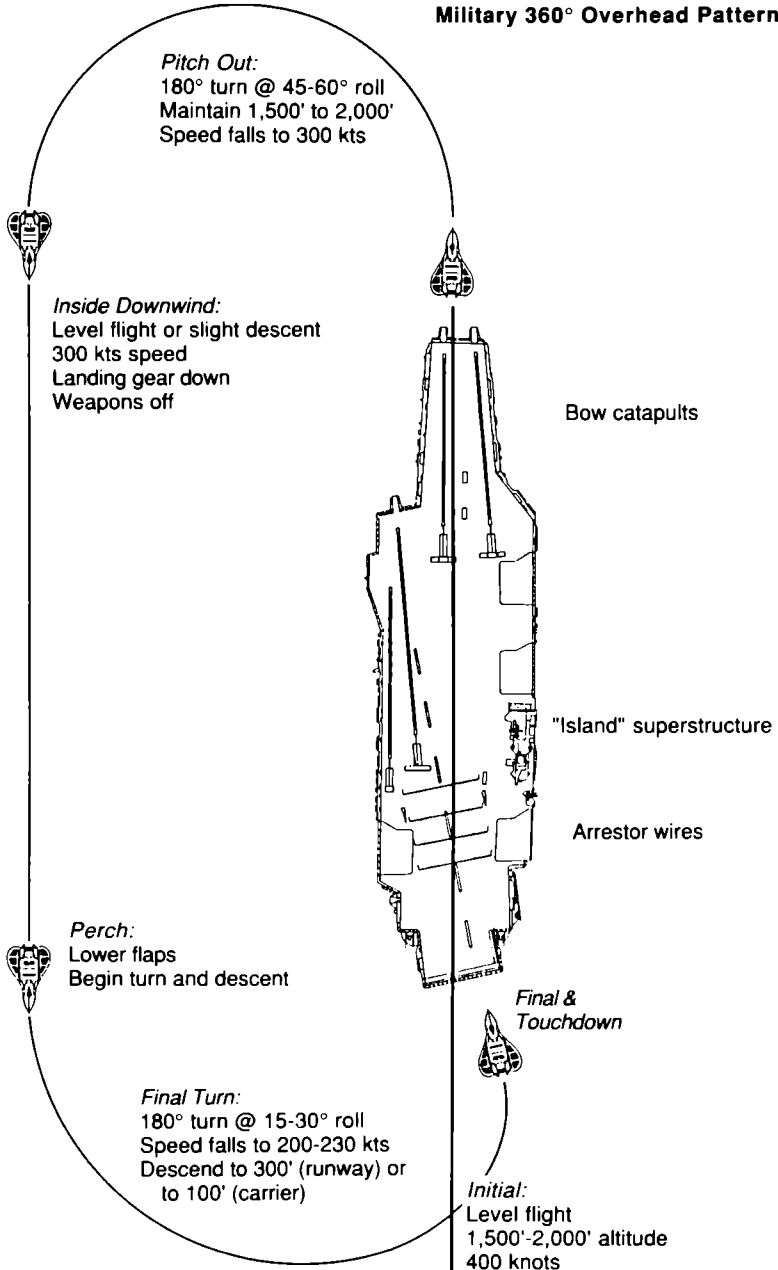



---

---

turn. You may need to raise or lower your nose in the turn to maintain your altitude in the turn.

**Inside Downwind:** When you finish the turn and level out, you're on the "inside downwind" leg of the landing. Immediately reduce the throttle and nose up a bit more to maintain level flight speed at 300 kts, then lower your landing gear. Make sure all your weapons are off (landing with armed weapons is considered very bad form).

**Perch:** Look to the side at the runway. When you are even with the end of the runway or carrier deck, you've finished the inside downwind and are at "the perch", ready to start the final turn. Don't be surprised if the first time you look, you're already at the perch — it comes up fast!

At this point you lower your flaps. Now pitch the nose down until your VVI indicates a descent. As you drop the nose begin your final turn.

**Final Turn:** This is a slow 180° descending turn. You will descend to about 300' (for a runway) or 100' (for an aircraft carrier) at 200 to 230 knot airspeed. Your roll should be 15° to 30° in the turn. Notice that the altitude gauge on the HUD gains speed and detail once you pass the 1,000' (1K) mark. Make sure you don't start out with too fast a descent.

Change your nose pitch up or down to control the rate of descent in this final turn. You should finish the turn with the runway or carrier deck dead ahead.

**Final:** When you finish the final turn lined up with the runway/carrier, pull the nose up to gain level flight, then back off a tiny bit for a very gentle descent. Change pitch to adjust your descent, and your throttle to adjust your speed. However, regulating your descent rate with pitch changes is the hard part. If you're too fast you can always cut the throttle or use the speed brake at the last minute, or come around again for another try.

**Touchdown on Runways:** When the wheels touch down on the runway, cut the throttle, lower the nose wheel to level, and apply the brakes. When you stop rolling turn off the engine.

**Touchdown on Aircraft Carriers:** When the wheels touch down on the stern of the carrier, you should snag an arrestor cable and stop immediately. Cut the throttle and turn off the engines.

---

---

## • Radar & Stealth •

### Radar

Radar sends high frequency electro-magnetic waves through the atmosphere at virtually light speed. These waves bounce off solid objects. Some bounce back toward the radar set, which includes a signal receiver. By measuring the strength of the returning signal, angles of returning waves, etc., radars estimate the range, position, and size of an object.

---

---

---

---

Radar waves bounce best from solid, dense, flat and perpendicular surfaces. Traditional aircraft shapes, especially aircraft engine intakes, slab-sided fuselages, and vertical tail surfaces make excellent radar reflectors.

## **Stealth Technology**

The radar reflections of an object are greatly reduced if its shape minimizes the returning waves. This does not make the object invisible, but does make it very hard to "see". For example, if a normal airplane is visible to a radar at 200 miles away, a carefully shaped airplane might be visible within 50 miles! Creating this shape in a form that is also aerodynamic requires extremely complex computer modeling. As the world's leader in computer applications, it's inevitable that America would be first in this field. The SR-71 spy plane is an early example of such shapes in aerodynamics, the redesign of the B-1 bomber fuselage is another example.

In addition to shape, certain rubber and ceramic compounds tend to "absorb" radar waves, making the return signal weaker than normal. Known generically as RAM (Radar Absorbent Material), it can be incorporated in paints, or planted in "wedges" along the surface of a wing or fuselage.

Finally, an airplane's heat signature is an important consideration. Many airplane-killing missiles home on heat sources. The newer longer-wavelength sensors see warm parts of the craft (such as leading edges of the wings, tail, and air intakes) heated by air friction. The main defense against heat-seekers is to incorporate heat-resistant materials onto edges that "cut" through the air, and to mask and disperse the hot engine exhaust as much as possible

"Stealth" is the combination of superior shapes and RAM materials that vastly minimizes the radar and infrared visibility of an aircraft. The F-19 design sacrifices speed, maneuverability, and payload for maximum stealth. The air intakes to the twin turbofan engines are masked. The fuselage is molded into the wing shape to eliminate hard angles, as well as letting the fuselage itself act as a "lifting body". The tail is twinned and tilted inward to reduce reflections. Upper and lower hull and wing surfaces are covered with RAM inserts. All weapons are carried internally, since external pylons and armaments are excellent radar reflectors. All leading edges incorporate heat-resistant surfaces. The jet exhaust is directed through slats that absorb heat and mix in cooler air to break up the rearward heat signature.

Stealth also demands a new approach to combat operations. For decades jet aircraft have carried radars of increasing power, using them to aim weapons, check altitude, and to fly low at high speeds. All this radar broadcasting often reveals a plane long before enemy radars discover it. A stealth aircraft must fly without active radar emissions. Any radar it carries should be reserved for brief periods of weapon use, after which the radar is turned off. Of course, the lack of terrain-avoidance or terrain-following radar makes low-level flying much more difficult.

Overall, the F-19 is most difficult to detect at very high or very low altitudes. Even at middle altitudes (10-20,000') it is far less visible on radar than a normal aircraft.

---

---

---

---

This not only allows the F-19 to “sneak up” on the enemy, it also reduces the range and accuracy of enemy weapons.

## Stealth Tactics

The F-19's stealth configuration is most effective when flying at very low altitudes (under 2,000', and preferably under 500'), or at very high altitudes (over 32,000'). It is least effective at medium altitudes, such as 15,000'. The EMV is further reduced if the engines are throttled back to cruise speed, and can be slightly improved if the engines are throttled back to well below cruise.

On the negative side, opening the weapons bay, firing a weapon, using jammers, or dropping decoys all raise the EMV, making the plane more visible. Tracking airborne targets turns on your air-to-air radar, increasing your EMV enormously. Note that some weapons automatically turn on your targeting radar. Check your EMV after arming a weapon, and make a habit of shutting down weapons if you don't need them.

On the plus side, if you want to deliberately “decoy” the enemy to a certain location, orbiting there with aerial tracking running is a fairly easy way to attract enemy attention (assuming they have good enough equipment and operators to see you at all!).

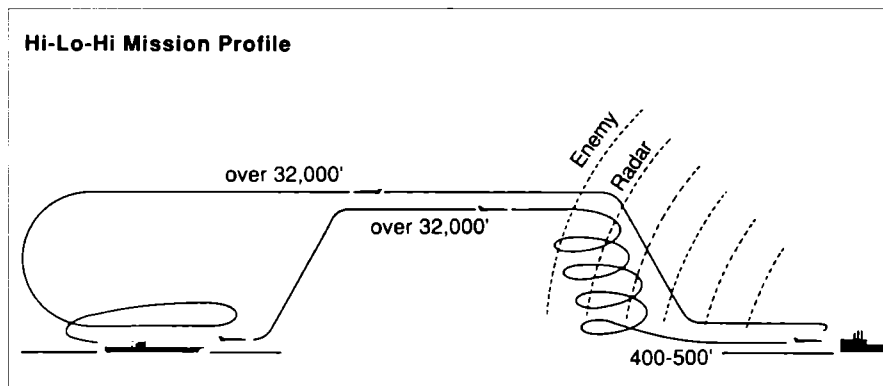

**Hi-Lo-Hi Mission Profile:** This mission technique also optimizes fuel, but uses a low-level final penetration. Begin the mission by climbing to 32,000'+ and flying fuel efficiently toward the target (“Hi”). At the first radar warning make a steep spiral dive to 400-500', then continue forward. Approach the mission area at very low altitude (under 500') with maximum use of terrain masking, such as flying between mountains (“Lo”). As the target comes into view, climb to attack altitude, release weapons, then dive away and exit radar range as quickly as possible. When the radar warning receiver indicates you are beyond enemy radar detection range, climb again to a high cruising altitude (over 32,000' - “Hi”) and return home.

**All-Lo Mission Profile:** This mission technique maintains a minimum EMV throughout, but is more costly in fuel. Begin with a climb to only 1,000-1,500', then

---

---

fly to the target at cruise speed. At the first sign of enemy radar or activity, drop to 450' and continue at low speed. All-manual low-level flight in the F-19 is rather difficult, since the plane needs constant small corrections, and at low power you have little margin for error. Once detected and under attack you may wish to climb above 1,000' and go to full throttle, since the extra altitude and power may prove vital when launching weapons, dogfighting, or making radical maneuvers to evade enemy attacks. After completing the mission, exit the area at 500', returning to 1,000-1,500' once the enemy radars lose you. If fuel is a problem, consider returning at high altitude (over 32,000') to conserve fuel.

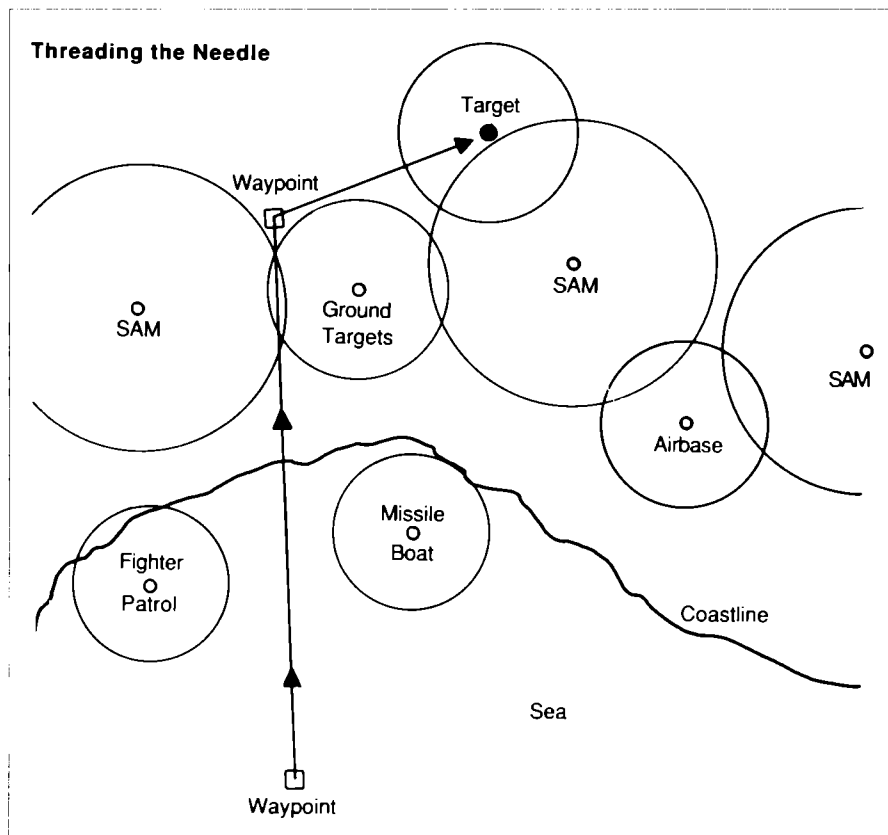

**Threading the Needle:** This technique is especially useful in deep-penetration raids where you must fly past front-line SAMs and airbases to more distant targets. Use a compass and on your map trace out circles showing the maximum search radar range of enemy SAMs and airbase radars along your course. Note areas of minimal overlap and outright gaps. Change your INS waypoints to guide you outside radar circles if possible, or if not, minimize the time you're within radar range. The less time you're in radar range, the less your chance of detection.

---

---

Enemy warships, fighter patrols and AEW&C radar planes still may cause unforeseen surprises. The AEW&C "Mainstay" is especially nasty: it may "see" you beyond the range of your threat display. You could be "pinged" by a Russian radar and not know where he is! The only answer is to make your best guess and minimize your EMV.

---

## • Weapons & Combat Tactics •

### Air-Ground Attack Techniques

Different weapons require different attack techniques. The standard techniques are explained below. Once you are skilled in these, feel free to experiment with your own methods and variations.

**Strafing Run:** This technique is used when firing your cannons at a ground target. In a strafing attack you fly low (under 500') and level, frequently with your speed brakes open. To attack a target, dip slightly and open fire, "walking" your cannon bursts across the target. Be sure to pull up before you hit the ground. When the run is complete, close the speed brakes, open the throttle to maximum, and turn away.

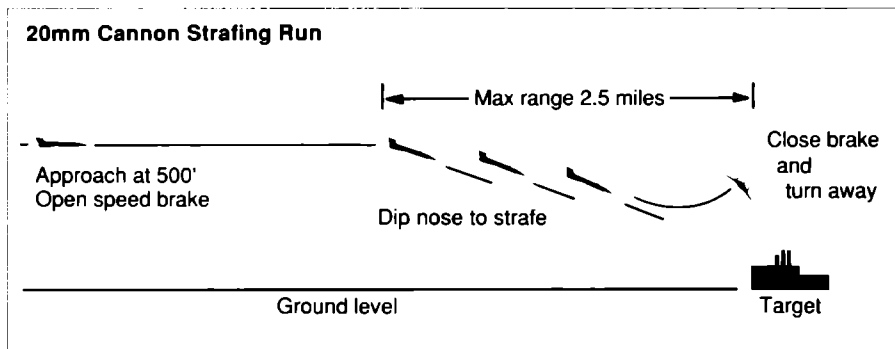

The most difficult problem in strafing runs is that your cannon range is only 2.5 miles, while ground targets visible out your cockpit may be considerably further away. Also bear in mind that many targets need more than one burst to destroy them. Finally, it's easy to become "target fixated" and fly into the ground because you ignored your altimeter.

**Fire-and-Forget Launch:** Make sure you're tracking the right target (ID targets and switch targets as necessary), make sure you're within the launch altitude parameters, and arm the weapon system.

Your accuracy is very low while the target box is still rectangular. When it turns oval, accuracy is reasonably good. If the oval turns color, accuracy is superior. If you wait another few seconds, accuracy continues to improve. The delays in this

---

---

**Fire-and-Forget Launch**  
(ground target illustrated)

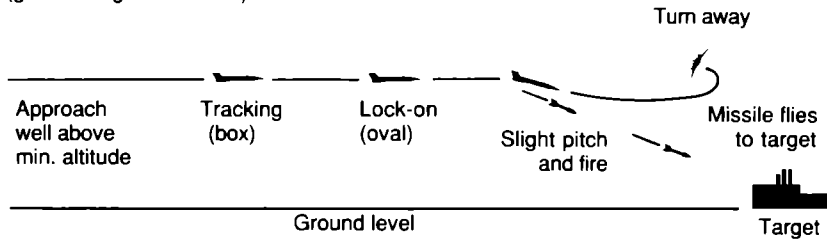

process occur because either (a) the missile isn't in range yet, or (b) the missile isn't locked onto the target yet. All this is calculated automatically by the HUD, you need not worry about ranges or timing.

Just before launching, if the target is below, nose down into a gentle dive; if the target is above, nose up into a gentle climb. This makes sure the missile starts with a useful vertical velocity.

Once the missile is launched you can change to new targets, new weapons, and maneuver as you wish. *Note:* The AGM-88A HARM missile has a 1,000' minimum altitude; don't waste one by launching it too low.

**Laser-guided Toss Bombing:** This technique is similar to fire-and-forget launches, except you should start well below maximum launch altitude. When you are ready to launch, make sure your plane has zero roll and is level or pitched up. A little pitch up while launching will "toss" the bomb, giving it greater glide range.

After you launch the bomb, do not roll or pitch more than 60 degrees. If you do, the laser may lose target lock. If the laser loses its lock, the bomb almost always misses. Once the bomb explodes, you're free to maneuver.

**Toss Bombing**

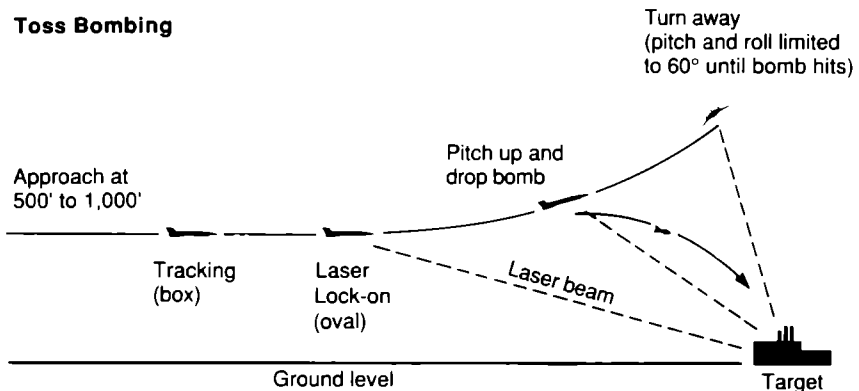

---

---

**Low-altitude Level Bombing:** This technique is used with retarded bombs. Approach the target in level flight between 500 and 2,000', preferably close to the upper limit. Try to fly so the "fall line" of your bombs is across the target. Flying with speed brakes out is often useful. Just before the target comes under the circular bombsight, drop down a little, bring the sight onto the target, and release the weapon. Once the bomb is dropped clear the area as quickly as possible to avoid blast effects.

If the bombsight moves off the HUD, it means the bomb is aimed at a point you can't see! You're flying too fast, climbing too steeply, or maneuvering too wildly. A gentle dive with wings level usually brings the bombsight back into view. If not, check your altitude, you may be much too high.

**Dive Bombing:** This technique is used with free-fall bombs. These bombs cannot be safely dropped below 2,000'. At higher altitudes the bomb aiming point is often invisible (off the HUD). Therefore, to place a bomb accurately you must dive. The traditional dive bombing attack starts around 10,000 feet. Dive-brake equipped aircraft might pitch down as much as -70°, but a plane with speed brakes (such as the F-19) should use -50° to -60°. After you drop below 8,000', release the bomb as soon as the bombsight circle is on the target, then begin your pull-out. For safety, either pull out or shallow your dive below 4,000'. See the illustration on the following page for additional details.

**Medium Altitude Level Flight:** This technique is used with your 135mm/IR cameras. You must fly medium-high (20,000' to 24,000') and perfectly level across the target area. Your INS system informs you when you're in the target area. While over the target run your cameras until all frames are used or you leave the area. On a good pass you can expend all your film within the target area. On a bad pass, you may leave the target area before expending all your film. In that case, come around for another pass.

Remember: A successful photographic mission requires a safe landing to deliver the film.

## **Air-to-Air Duels**

*Warning:* When tracking air targets, or when air-to-air weapons are armed, your air radar is running. This greatly increases your EMV. In effect, finding or shooting at air targets ruins your "stealthiness". Therefore, shut down to EMCON as quickly as possible after firing.

**Active Radar-Homing AAMs:** These "fire and forget" radar-guided missiles are intended for use at medium and long ranges. The aircraft carrying them identifies a target using its radar, and activates the missile. The missile carries its own radar set, which also locks onto the target. Once locked on it can be launched. Once launched the missile guides itself; the firing aircraft can turn off its own radar and/or maneuver freely. The American AMRAAM and Russian AA-10 are the only operational missiles of this type.

**Semi-Active Radar-Homing AAMs:** These are older, more common long-range radar-guided missiles. To use this missile, the aircraft carrying it identifies a

---

---

## Dive Bombing

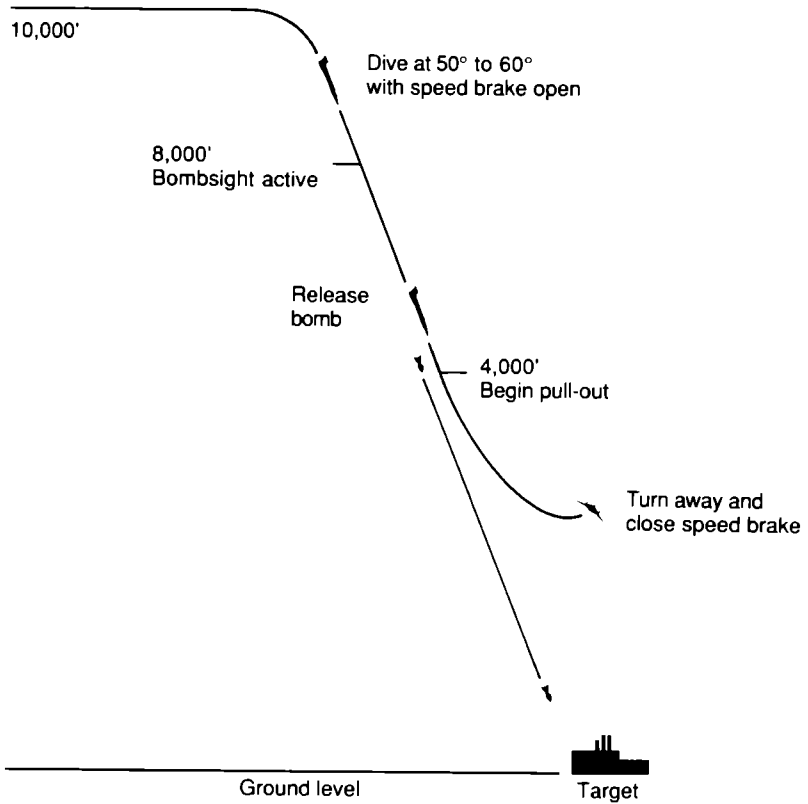



---

---

target with its radar and activates the missile. The missile carries only a radar receiver, which locks onto the radar waves bouncing back from the target. After the missile is launched the pilot must continue to "paint" the enemy with his radar while the missile flies to target. If the pilot turns off his radar, the missile gets no radar signal, "goes stupid" and misses. Most fighter aircraft radars only point ahead, so guiding these missiles forces the fighter to keep flying toward the target.

Russian AA-6, AA-7 and AA-9 missiles all are semi-active radar homers. The AIM-7F Sparrow, available to Iranian F-4's, is also a semi-active radar homer. No semi-active radar homing missiles are available to the F-19 (a stealth aircraft has no use for a missile that requires it to fly at the target, broadcasting loud radar signals).

**Infrared (IR) Homing AAMs:** To launch an IR AAM the firer activates the missile. The missile's IR seeker in the nose turns on and searches for a heat source. Modern IR seekers have special filters, logic circuits, and cryogenic cooling to make sure they only "see" aircraft type heat sources. (Earlier, less sophisticated missiles sometimes locked onto the sun, common flares, greenhouses, or even hot rocks and sand). Once the seeker is locked on, the missile steers itself to the target. Therefore IR missiles are "fire and forget" missiles.

Originally IR missiles locked onto the hot exhaust of a jet engine. This required getting behind the enemy to achieve lock-on. More sensitive and sophisticated seekers can now lock onto any hot surface, including the leading edges of wings, air scoops, etc., where air friction heats the plane's metal skin. (The AIM-9M Sidewinder is the most sophisticated of these missiles.) These surfaces are visible at all angles, but a nose-on or top-down shot is best.

**Aircraft Guns:** Jet aircraft travel so quickly that conventional machine guns and cannons cannot fire quickly enough to guarantee a hit: a plane could literally fly between the shells. Therefore, modern aircraft cannon are either a group of guns (such as the twin 23mm cannons in many Russian MiGs) or a multi-barrel gatling gun (such as the six-barrel 20mm M61A1 on most American jets). Cannons also fire explosive shells, while machine guns fire less destructive solid lead slugs. Aircraft cannons have an effective range of 0.3 to 2.5 miles. Within 0.3 miles the explosion of an enemy plane could damage your craft.

The traditional radar gunsight is a "predicting" gunsight. The sight predicts where shells will hit if you fired right now. Cannon shells take about a second to travel 2.5 miles. Therefore, to make the "prediction" come true, the enemy must stay within the gunsight for that second of time. From the firer's standpoint, therefore, he must shoot and hope the enemy remains aligned with his gunsight "pipper" until the shells arrive. Any change in the enemy's course tends to cause a miss.

A recent development is the "historical" sight, used on some of the latest USAF planes, including the F-19. Here the sight shows where shells would now exploding, *if* the pilot fired at the correct time in the past (about one second ago for a 2 mile range). As a pilot, you wait until your gunsight and the enemy plane are about to converge, then fire. Your eyeball and brain can time the convergence far, far better than any computer system, especially since convergence depends on both planes are maneuvering. Novice pilots, unskilled at estimating closing rate, can still use the "hold the sight on the target" technique with this sight.

---

---

---

---

## Immelmann Turn

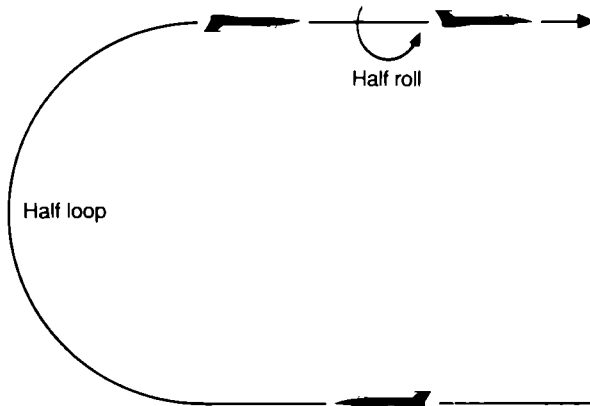

**Tracers:** This ammunition is mixed with regular shells so that a pilot can see where his guns are firing. However, tracers are visible to the enemy as you fire. Often the first clue a pilot has of an attack are the tracer shells going past him. Removing tracers from the ammunition, standard practice for the F-19, gives the enemy no warning until your shells hit. Robert Shaw, USN, quotes WWII ace Colonel Charles King as saying: "[The commanding officer] ordered the tracer ammo removed... I'll never forget the spectacular results we got. Our kill rate went up from 50 to 100 per cent."

**The Bounce:** The best way to start air-to-air combat is to surprise your opponent. If your stealth fighter has been discovered and enemy planes approach, go to minimum EMV and try to escape enemy radar detection. Once invisible to the enemy, you can use your threat display to guide you toward the enemy planes and ambush them. Wait as long as possible before activating your air targeting and weapons.

If the enemy "bounces" you, immediately evade any incoming missiles. Then you can either begin dogfighting to get the upper hand, or attempt to escape.

**The Missile Exchange:** If the enemy equipment is too good and/or their operators too skillful, you will be forced into a head-to-head duel with enemy planes. These duels usually begin with an exchange of radar-missiles. Be prepared to jam or decoy such a missile, and begin turning early so that as you and the enemy pass, your turn for another "pass" has already started. Of course, if you turn too early, the enemy will simply turn onto your tail!

Sometimes planes have time for two missile exchanges: first an exchange of long-range radar missiles, then short-range IR missiles.

---

---

---

---

**Dogfighting:** The essential rule in dogfighting is to get on the enemy's tail. On all fighter aircraft, guns and missile guidance systems only face forward. If you're on the enemy's tail, you can shoot and he cannot. If you can't get on his tail, at least try to place his aircraft ahead of you as much as possible, so you have the maximum number of firing opportunities.

Maintaining higher speed or altitude is valuable in a dogfight. A plane slower and lower can only dodge attacks. A plane faster or higher can attack or retreat as desired. Having a higher speed or altitude is termed the "energy advantage".

If the enemy is behind you, there are various classic escape maneuvers: Turning Inside, the Scissors, the Immelmann, the Split-S, and the Yo-Yo. Not all of these are useful to the F-19, but you may see an opponent try them.

**Immelmann Turn:** This maneuver is an excellent way to reverse direction quickly. First you perform a half loop upwards to reverse direction, then a half roll to right your aircraft. If an enemy aircraft is behind you, an Immelmann can bring you nose-to-nose with him. The original Immelmann; a German WWI fighter pilot, reputedly rolled while climbing, rather than rolling afterward, to make his plane harder to hit during the maneuver.

Note that an Immelmann causes you to gain altitude but lose speed, since a half-loop upward slows you down significantly.

**Split-S Turn:** This maneuver complements the Immelmann. Begin by rolling inverted, then pull the stick back to half-loop downward. Many pilots begin the loop before the roll is completed, rolling the plane while looping. The split-S causes you to lose considerable altitude, so it's often wise to reduce throttle and/or use speed brakes to minimize altitude loss.

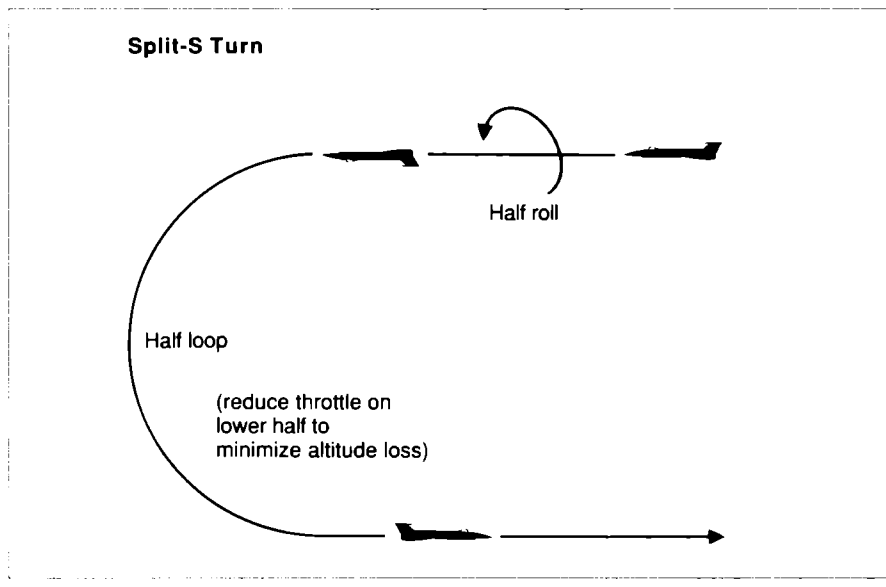

**Early Turn**  
on a head-to-head pass

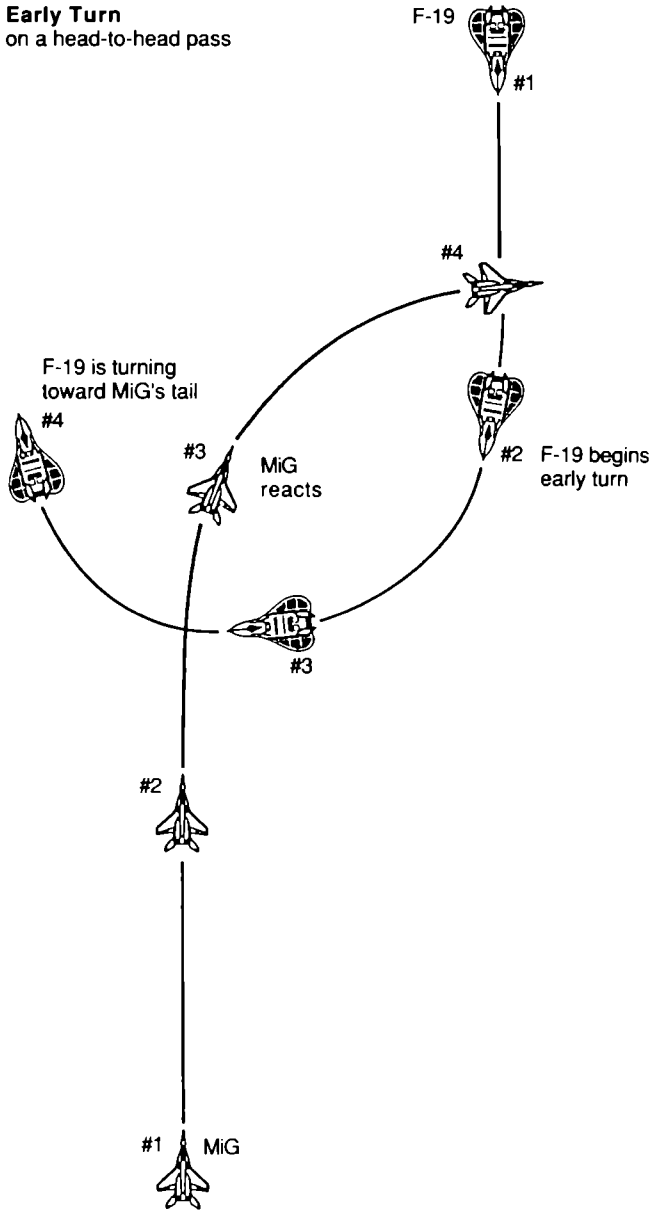

The Split-S complements the Immelmann because you gain speed and lose altitude. Unwary pilots fighter pilots have sometimes tried to Split-S into or away from the enemy without remembering their altitude. The result can be a Split-S right into the ground!

**Turning Inside:** The simplest solution to an enemy plane coming up behind you is: turn toward him (i.e., turn in the direction of the enemy aircraft). If you're turning faster than he, the enemy plane will appear to "revolve" around the threat display toward your front, eventually appearing in front of you on your HUD.

However, if the enemy is turning faster than you, he will appear to drift further and further behind you on the threat display. This is dangerous, since he's lining up for a shot at your tail!

**Yo-Yo Turn:** This maneuver is used mainly by higher speed jets against slower opponents. Therefore the relatively slow F-19 has little occasion to use it dogfighting. However, you may see enemy MiGs attempting it against you! This turn also requires excellent cockpit visibility, something that both the F-19 and early MiGs lack.

In a Yo-Yo turn you climb and roll toward the enemy — until he's visible out the top of your canopy. Then pull over into a dive while still turning. The enemy plane will shift to the left or right as you pull over, then gradually rotate around to your nose as you complete the curving dive. In effect, the Yo-Yo plane has made a very big

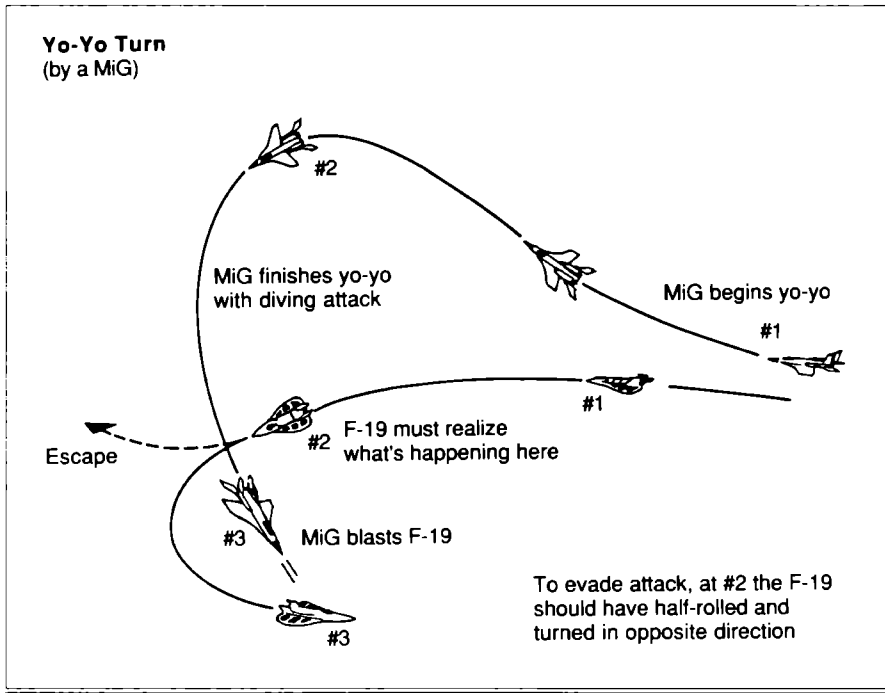

# Scissors Turn

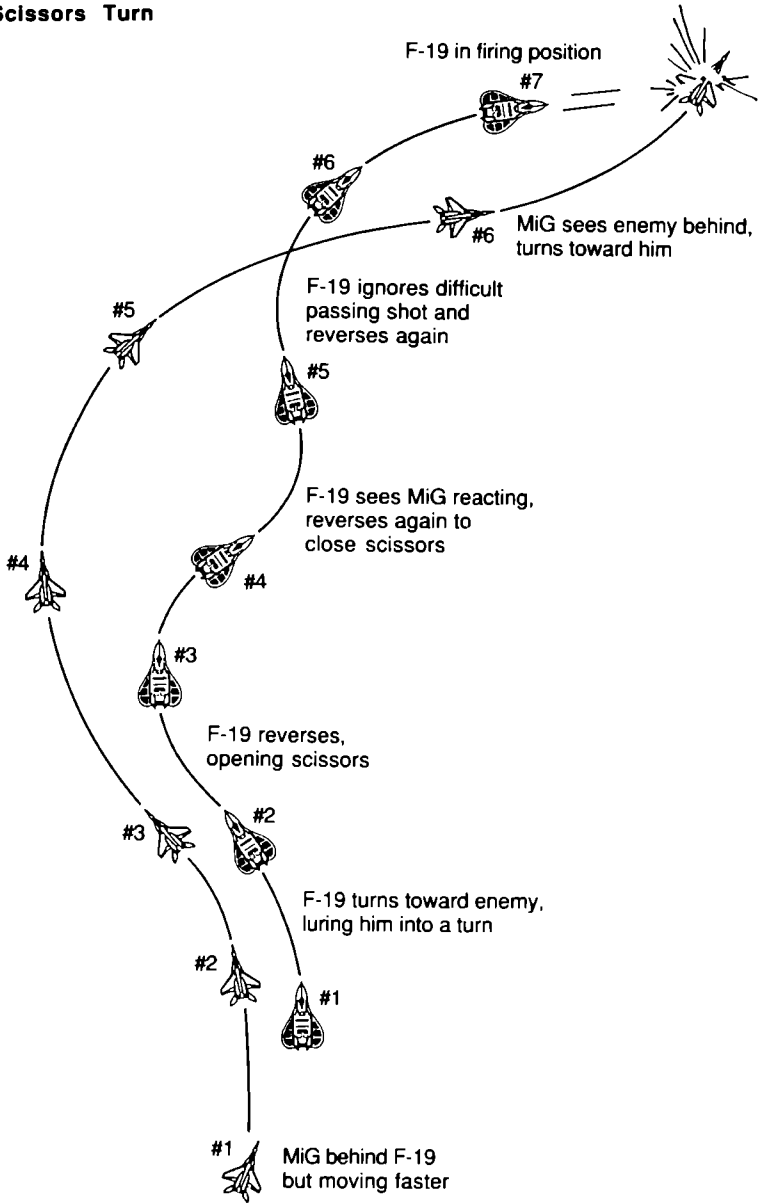

---

---

turn, but most of it was "consumed" with the climbing and diving, allowing a faster plane to travel further and turn wider, yet still come out on the tail of the slower plane. American F-4 Phantom pilots used this maneuver with great success against slower but more maneuverable MiG-21's over North Vietnam during the Vietnam war.

**Scissors:** A more complex way to out-turn an enemy aircraft is the scissors maneuver. Begin a turn toward him, but once he begins to turn with you, quickly roll over to turn in the other direction. This opens the scissors. As the enemy realizes you've turned away and turns toward you again, you reverse the procedure and roll back toward him again. If your turns were quicker and tighter than his, and/or you're a slower plane, he will eventually pass in front of you. This allows you to get onto his tail.

Novice pilots trying to keep turning with you can be lured into a scissors with ease. Sharp enemy pilots may avoid the tactic by anticipating a turn and blasting you (if they're less maneuverable), or by pulling up and over in a yo-yo (if they're faster).

## **Surface-to-Air Missiles (SAMs)**

To cope with enemy SAMs, you should understand the principles of their operation. Then you can intelligently apply the appropriate defense.

**Radar-Controlled SAMs** are the standard long-range SAM. First the search radar scans the sky to find your plane, often supplemented by passive radar receivers and thermal detectors, not to mention normal eyesight.

When the search system finds your plane, it "hands off" to a narrow-beam fire control radar, usually running on a different frequency. This narrow beam locks onto your craft. When the fire control operators are sure their beam is tracking correctly, they launch a missile.

After the missile is launched the fire control radar still must track you, guiding the missile toward your aircraft. Some missiles home on the radar reflecting from your craft ("semi-active homing"), for others the fire control center receives the reflections and then sends the missile mid-course corrections ("command guidance"). In the final stages of flight the missile may activate an infrared homer to insure a kill.

Some very modern SAMs use cameras or lasers to track the target, instead of fire control radar. Of course, cameras and lasers are blinded by bad weather and have a short range compared to radar.

**Infrared (IR) SAMs** search and find a target just like a radar SAM. Long range IR SAMs are linked to a search radar system, but cheap, short-range IR SAMs often rely on the gunner finding the target by eyesight alone.

Once acquired, the target may be tracked by eyesight, cameras, or radar. The missile is aimed along the tracking line and its infrared seeker turned on. When the seeker locks onto your plane, the missile is launched. From that point onward the missile steers itself, using its seeker.

---

---

---

---

Infrared seekers home on heat sources. Early versions could be confused by the sun, common distress flares, even greenhouses or sun-heated rocks. More modern missiles have filters, improved seeker technology and computer logic to make them more accurate and sensitive. Meanwhile, decoys now are sophisticated strobing heat-sources (IR jammers) that "convince" a seeker that it is malfunctioning or locked onto the wrong target.

**Stealth & Missile Defense:** Classic missile defense measures such as jammers and decoys have a annoying habit of increasing your EMV while the defenses are running.

Running away from missiles may seem a good strategy, since many missiles lack the fuel to reach you in a "tail chase". However, this burns up lots of fuel flying in the wrong direction, while high speed increases your EMV as much as jammers or decoys.

A more sophisticated tactic is to fly low (under 500') and throttle back your engines. This gives the lowest possible radar profile (absolute minimum EMV). If a radar installation loses you, their missile also loses you.

**Jamming or Decoying Radar Missiles:** When the RWR alerts you to enemy SAM fire control tracking, it's time to consider countermeasures. If you're close to the SAM site (within 12 miles), activate your ECM jammer quickly. If you wait for the missile guidance warning, it may be too late! If the enemy SAM launcher is further away, wait until the missile is within 12 miles, or closer, before using your jammer.

If the jammer is damaged, or the missile is still maneuvering toward you with the jammer running, turn off the jammer and drop a decoy. If that doesn't work, outmaneuver it instead.

**Jamming or Decoying IR Missiles:** When your IRW lights up, a missile has been launched against you. Most are launched at close range: your first reaction should be turning on IR jammer. Then check the threat display. If the missile is beyond 12 miles or so, wait until the missile is closer.

If the jammer is damaged, or the missile is clearly tracking toward you with the jammer running, turn off the jammer and drop a decoy. If that doesn't work, try outmaneuvering it.

**Defensive Timing:** Remember, jammers only run so long before overheating shuts them down. Decoys also have a finite time limit. Timing is everything: if you use defenses too soon they run out at just the wrong time and you're toast. If you wait too long, the missile will get within range of its proximity warhead and damage your craft anyway. Ideally you should run the decoy and/or jammer from 2-3 seconds before the missile arrives to 2-3 seconds after it misses you.

**Outmaneuvering a SAM:** If your normal jammers and decoys are damaged, or you're trying to maintain a minimal EMV, you can still outmaneuver the missile. The turning arc of a missile is larger than your plane. If the missile is trying to fly up your tail, roll over into as tight banking turn. The missile will turn wider, flying past you on the outside.

---

---



## Evading a Missile

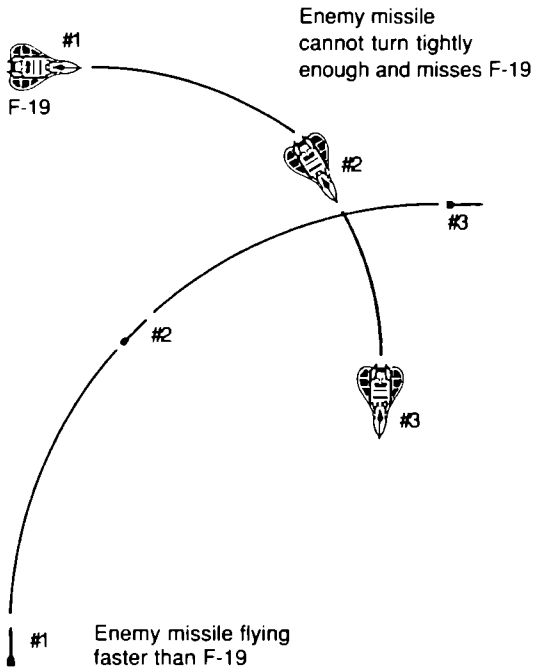

If a SAM approaches from the side, turn toward it, increasing the tightness of your turn as it comes closer. Keep the missile's course at right angles (perpendicular) to your own. If the missile cannot turn with you, it will gradually fall behind, ultimately zooming past behind you.

If a SAM approaches you from the front, wait until it's within 15 to 25 miles range. Then make a quick turn to place the missile facing your side. Once it's facing your side, you can bank back toward it, outmaneuvering it like any other side-attacking missile.

**The Cautious Pilot** turns on his jammer, drops a decoy and outmaneuvers the missile too. It's often difficult to determine whether if missile is confused by a jammer or still flying toward you. A cautious pilot assumes the worst and uses more defense. A bold pilot assumes the missile has "gone stupid" and ignores it. It's a common maxim that there are no old, bold pilots.

## • Weapons Data •

### USAF Ordnance

#### M61A1 20mm Cannon

*Quantity:* 1 fixed internally

*Targets:* Aircraft

*Effective Range:* 2.5 miles

*Maximum Speed:* Mach 3 muzzle velocity

*Minimum Altitude:* Effectively unlimited

*Maximum Altitude:* Effectively unlimited

*Attack Technique:* Dogfighting attack or strafing run

This six-barrel gatling-gun type cannon is the standard internal armament of most

---

---

US fighters today, including the F-4, F-14, F-15, F-16 and F-18. It can fire 6,000 rds/minute, but ammo storage is limited on fighter aircraft (the F-19 has 650 rds).

### **AIM-9M Sidewinder**

Infrared air-to-air homing missile

*Quantity on rack:* 4

*Targets:* Aircraft

*Effective Range:* 11 miles

*Maximum Speed:* Mach 3+

*Minimum Launch Altitude:* 300'

*Maximum Launch Altitude:* Effectively unlimited

*Attack Technique:* Dogfighting attack

Almost every aspect of this missile has been redesigned and upgraded numerous times. The "M" model is the latest, with a greatly improved all-aspect seeker head, a new warhead and an improved rocket engine. Although an "N" model exists, it represents rebuilds of early "B" and "E" models and is less reliable.

### **AIM-120A AMRAAM**

Radar guided air-to-air homing missile

*Quantity on rack:* 3

*Targets:* Aircraft

*Effective Range:* 18 miles

*Maximum Speed:* Mach 4

*Minimum Launch Altitude:* 150'

*Maximum Launch Altitude:* Effectively unlimited

*Attack Technique:* Dogfighting attack

This the West's first radar-guided "fire and forget" missile. The AMRAAM (advanced medium range air-to-air missile) has its own inertial guidance, on-board track-while-scanning radar, and computerized target discrimination. Preproduction and early production models are becoming available to Stealth units.

### **AGM-88A HARM**

High speed anti-radiation ("homes on radar") missile

*Quantity on rack:* 1

*Targets:* Ground or Sea based radars

*Effective Range:* 11 miles

*Maximum Speed:* Mach 2+

*Minimum Launch Altitude:* 1,000'

*Maximum Launch Altitude:* 60,000'

*Attack Technique:* Fire-and-forget launch

This is America's most advanced anti-radar missile. It can lock and home on hostile radars even if they jump frequencies or not transmitting — by homing on radar set components. It can also be fired "blind" and will loiter airborne, waiting until a hostile radar appears, then attack it. This last "blind fire" mode is not available to F-19 HARM launches.

### **Penguin-3 ASM**

Medium altitude infrared homing anti-ship missile

*Quantity on rack:* 2

*Targets:* Ships

*Effective Range:* 16 miles

---

---

---

---

*Maximum Speed:* Mach 0.8  
*Minimum Launch Altitude:* 300'  
*Maximum Launch Altitude:* 30,000'  
*Attack Technique:* Fire-and-forget launch

Designed by Norway, this modest missile is launched under inertial guidance. At a pre-designated point slightly before the target it switches to an infrared homer for the final attack. The missile is not a sea-skimmer, making it easier to shoot down. However the missile does not broadcast its presence with radar. Maximum range is supposedly over 50 miles with a high-altitude launch, but a closer range is necessary on F-19 missions.

### **AGM-84A Harpoon**

Sea-skimming radar & inertial guided anti-ship missile

*Quantity on rack:* 1  
*Targets:* Ships  
*Effective Range:* 30 miles  
*Maximum Speed:* Mach 0.8  
*Minimum Launch Altitude:* 300'  
*Maximum Launch Altitude:* 30,000'  
*Attack Technique:* Fire-and-forget launch

The Harpoon is the standard anti-ship missile of the American Navy and Air Force. This weapon is more powerful, longer ranged and harder to stop than the Penguin. It is launched under inertial guidance with considerable computer assistance, flies at sea-skimming altitude to avoid detection, then it uses radar to home-in on the target. The end of the flight it pops up and dives steeply into the target ship.

### **AGM-65D Maverick**

Thermal imaging air-to-ground guided missile

*Quantity on rack:* 2  
*Targets:* Bunkers, tanks and AFVs, missile revetments, ships  
*Effective Range:* 16 miles  
*Maximum Speed:* Mach 1+  
*Minimum Launch Altitude:* 300'  
*Maximum Launch Altitude:* 30,000'  
*Attack Technique:* Fire-and-forget launch

The Maverick is America's standard air-to-ground guided missile. The original version locked on a TV image and flew toward that. Later versions added zoom lenses, lasers, and ultimately in the "D" model, a forward-looking infrared (FLIR) thermal imaging system. The missile carries a shaped-charge warhead designed to penetrate hardened targets. A naval version has a variant warhead for use against ships.

### **GBU-12 Paveway**

Laser-guided glide bomb

*Quantity on rack:* 2  
*Targets:* Buildings, bunkers, oil facilities  
*Effective Range:* 0.5 miles  
*Maximum Speed:* Glide bomb  
*Minimum Launch Altitude:* 500'  
*Maximum Launch Altitude:* 3,500'

---

---

---

---

*Attack Technique:* Laser-guided toss bombing

In this weapon, the pilot locks the laser illuminator on the target, then launches the bomb, which glides to the target point illuminated by the laser. The laser is mounted on gyroscopic gimbals underneath the plane's nose. It tracks the target independent of the plane's maneuvering. However, the pilot should neither roll nor pitch more than 60°, the limit of the gimbal's train. As with all laser weapons, rain, snow, dust and smoke can weaken the laser beam, reducing accuracy.

### **Mk 20 Rockeye**

Retarded fragmentation cluster bomb

*Quantity on rack:* 2

*Targets:* Buildings, missile revetments, ships, oil facilities

*Effective Range:* Nil

*Maximum Speed:* Retarded bomb

*Minimum Launch Altitude:* 500'

*Maximum Launch Altitude:* 2,000'

*Attack Technique:* Low-altitude level bombing

This cluster bomb breaks open about 100' above the surface, spinning out 247 shaped-charge bomblets that destroy buildings, armored vehicles, and people. The opening height and pattern can be pre-set for various types of targets. The U.S. Navy used this bomb with great effect against warships. In 1986 a single cluster bomb wrecked a Libyan Nanuchka-class missile boat.

### **Durandal Bomb**

Parachute-deployed runway penetration bomb

*Quantity on rack:* 2

*Targets:* Runways and roadways

*Effective Range:* Nil

*Maximum Speed:* Retarded bomb

*Minimum Launch Altitude:* 500'

*Maximum Launch Altitude:* 2,000'

*Attack Technique:* Low-altitude level bombing

This French-made anti-runway weapon is standard in the USAF (no satisfactory equivalent is made in the USA). When released over target, the Durandal deploys a parachute to float nose-down and roughly stationary over the runway surface. Then it fires a rocket motor and blasts straight down through the runway concrete, exploding about a yard below the surface. This heaves up large sections of concrete. Heavy equipment and considerable time is then needed to make the runway functional once more.

### **Mk 82-0 "Slick"**

Free-fall high-explosive ("iron") bomb

*Quantity on rack:* 3

*Targets:* Buildings, bunkers, missile revetments, ships, oil facilities

*Effective Range:* Nil

*Maximum Speed:* Free-fall bomb

*Minimum Launch Altitude:* 2,000'

*Maximum Launch Altitude:* 8,000'

*Attack Technique:* Dive bombing

This weapon is the traditional 500 pound high explosive bomb, virtually unchanged

---

---

---

---

in concept since WWII. It can be placed with fairly good accuracy in a dive-bombing attack. At altitudes below 2,000' the fuse may not arm correctly, causing duds. This occurred frequently in the Falklands war of 1982: Argentine pilots hit British ships from 50', but their bombs failed to explode!

### **Mk 82-1 Snakeye**

Retarded high-explosive ("iron") bomb

*Quantity on rack:* 3

*Targets:* Buildings, ships

*Effective Range:* Nil

*Maximum Speed:* Retarded bomb

*Minimum Launch Altitude:* 500'

*Maximum Launch Altitude:* 2,000'

*Attack Technique:* Low-altitude level bombing

Retarded bombs use a parachute or vanes to slow their descent. As a result, they are dropped at lower altitudes than free-fall bombs. However, they are less accurate, and therefore unsuitable against some targets. The Snakeye is the standard vane-type retarder unit for many US bombs, here attached to a standard 500 lb. high-explosive bomb.

### **Mk 20 Rockeye II**

Laser-guided high-explosive cluster bomb

*Quantity on rack:* 2

*Targets:* Buildings, bunkers, missile revetments, oil facilities

*Effective Range:* 0.5 miles

*Maximum Speed:* Glide bomb

*Minimum Launch Altitude:* 500'

*Maximum Launch Altitude:* 3,500'

*Attack Technique:* Laser-guided toss bombing

This weapon uses a Rockeye cluster bomb combined with the Pave Tack laser guidance system (similar to that used in the GBU-12 Paveway). The result is a cluster bomb that can be dropped with pin-point accuracy.

### **Mk 122 Fireye**

Free fall incendiary ("fire") bomb

*Quantity on rack:* 2

*Targets:* Buildings, bunkers, armored vehicles, radar stations, missile revetments, oil facilities

*Effective Range:* Nil

*Maximum Speed:* Free-fall bomb

*Minimum Launch Altitude:* 2,000'

*Maximum Launch Altitude:* 8,000'

*Attack Technique:* Dive bombing

This weapon contains incendiary gel that spreads a burning liquid over a wide area. The liquid can flow into vents, grates, weapon slits, etc., making it effective against vehicles and fortifications as well as more open targets.

### **CBU-72 FAE**

Retarded triple fuel-air explosive overpressure bomb

*Quantity on rack:* 2

*Targets:* Bunkers, submarine pens

---

---

## F-19 Steath Fighter

Created at the Lockheed 'Skunk Works' in Burbank, California, this novel aircraft sacrifices almost everything to a nearly invisible radar signature. The shape minimizes radar reflections, and a large quantity of RAM (Radar Absorbent Material) panels, wedges and coatings are located on the ventral and dorsal surfaces, including the wings. All leading edges are cased in heat-resistant ceramics for minimum infrared signature, while engine exhausts are directed through low-signature slats.

The aircraft is designed for all-weather reconnaissance and strike missions, but can use its internal 20mm cannon, AIM-9 Sidewinder, or AIM-120 AMRAAM missiles for air-to-air interception and combat. The aircraft is air-transportable in C-5A Galaxy transports, and can be launched and recovered from US Navy aircraft carriers.

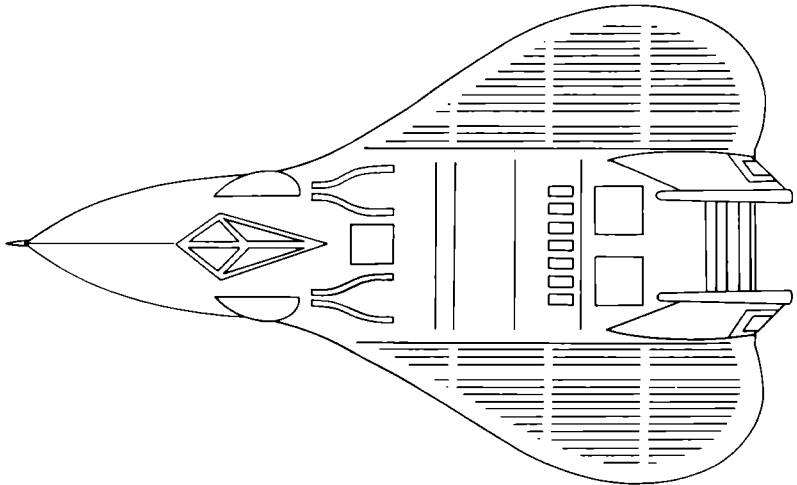

*Designer/Manufacturer:* Lockheed, USA

*Role:* Stealth strike fighter

*Crew:* One

*Wing Span:* 31'8"

*Overall Length:* 59'0"

*Overall Height:* 13'2"

*Mission Weight at Takeoff:* 17 tons

*Engine(s):* Two General Electric F404-GE-100A turbofans with  
no afterburners for 34,000 lbs thrust

*Range:* 520 miles

*Ceiling:* 64,000'

*Maximum Speed in level flight at 0':* 530 kts (Mach 0.8)

*Maximum Speed in level flight at 36,000':* 640 kts (Mach 1.1)

*Armament:* 6-barrel 20m cannon, 4 internal weapon bays with  
maximum combined load of 6,000 lbs

*Air-Air Radar Quality:* Medium quality and range doppler radar

*Maneuverability:* Fair to good

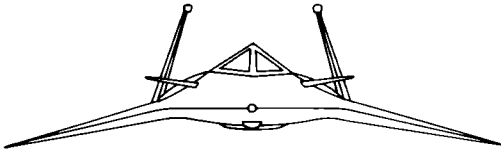
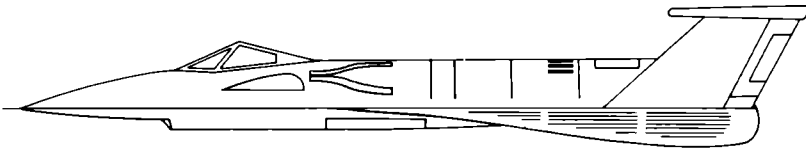

*Effective Range:* Nil

*Maximum Speed:* Retarded bomb

*Minimum Launch Altitude:* 500'

*Maximum Launch Altitude:* 2,000'

*Attack Technique:* Low-altitude level bombing

This bomb dispenses three 100-lb. cannisters of incendiary gas that is slightly heavier than air. A delayed-action fuse ignites the gas. The result is a high pressure explosion. In the open, this sets off mines, and flattens men and other soft objects. If the gases penetrate and explode in an enclosed area, such as a bunker or underground submarine pen, the effect is greatly magnified. Walls, floor and roof crack and blow outward, while anything within is thoroughly pulverized.

### **Mk 35 IN Cluster**

Retarded incendiary cluster bomb

*Quantity on rack:* 2

*Targets:* Buildings, radars, missile revetments, oil facilities

*Effective Range:* Nil

*Maximum Speed:* Retarded bomb

*Minimum Launch Altitude:* 500'

*Maximum Launch Altitude:* 2,000'

*Attack Technique:* Low-altitude level bombing

This cluster bomb is similar to the Rockeye, but filled with 57 incendiary bomblets. When the cluster breaks open, bomblets fly out and explode. Each one spreads a burning liquid wherever it lands. The result is a wide area of coverage, but a less concentrate effect at the target point.

### **ISC B-1 Minelets**

Parachute-deployed minelet dispenser

*Quantity on rack:* 1

*Targets:* Buildings, missile revetments, runways and roadways

*Effective Range:* Nil

*Maximum Speed:* Retarded bomb

*Minimum Launch Altitude:* 500'

*Maximum Launch Altitude:* 2,000'

*Attack Technique:* Low-altitude level bombing

This extremely new weapon breaks open at altitude and dispenses a variety of anti-personnel and anti-vehicle minelets. Used on airfields, they prevent flight operations until cleared. Clearing the mines is difficult because of the anti-personnel mines and delayed fuse weapons mixed in.

### **135mm/IR Cameras**

Photographic reconnaissance cameras

*Quantity on rack:* 1

*Targets:* Any

*Effective Range:* Nil

*Maximum Speed:* Remains internal

*Minimum Altitude:* 20,000'

*Maximum Altitude:* 24,000'

*Attack Technique:* Medium-high altitude level flight

This pallet contains a 135mm high-resolution camera for use in visible light, and a



---

---

second camera for infrared (IR) thermal photography. Each camera has a 500-frame magazine, and both cameras run simultaneously, to achieve coordinated coverage.

### **1500 lbs Extra Fuel**

Additional fuel for extended range flying

*Quantity on rack:* 1

*Other Data:* Not Applicable

This fuel container gives extra range with the minimum container weight. It replaces the weapons mounting equipment in one bay. The fuel can be transferred to the main tanks with a flip of the switch. The F-19 fuel lines run only to the main tanks, the engines *cannot* be fed directly from an extra tank.

## **Surface-to-Air Missiles (SAMs) Weapons Table**

A detailed tabular listing of various SAMs appears on page 64.

**Systems:** The SA-series are Russian ground SAMs. The SA-N- series are Russian SAMs on warships. Libya and Warsaw Pact nations also use these weapons. The Hawk, Rapier, Tigercat and Seacat are western SAMs used by the Iranian armed forces in the Persian Gulf.

**Mounting:** *AFV* weapons are mounted on armored fighting vehicles that are difficult to knock out. *Unarmored* weapons are mounted on light vehicles that are easier to destroy. Therefore, they are often entrenched in revetments and the radars sited in bunkers. *Warship* weapons are mounted on naval ships.

**Search:** The SAM's search system must find you before the SAM can fire. Radar systems are rated for quality and range. Lower quality radars are less likely to find your craft. Ranges in small ONC map coordinates are noted in parenthesis. Note that some weapons have no search radar. These SAMs rely on old-fashioned eyeballing-the-enemy to find their target.

**Firing:** The firing system may use radar or IR (infrared) guidance. The quality of the guidance affects the likelihood of successful jamming and decoys. For example, a missile with poor radar guidance is easier to jam than a missile with great radar guidance. Missiles with visual guidance and joystick control are especially inaccurate due to operator errors.

**Max Speed:** The maximum speed, given in Mach (speed of sound) values, is purely approximate.

**Max Altitude:** Missiles cannot hit targets flying significantly higher than the maximum altitude of that missile. Maximum altitude of the F-19 is 64,000'.

**Flight Maneuverability:** This is a general measure of how fast the missile turns. Missiles with poor maneuverability are easier to evade.

## **Air-to-Air Missile (AAMs) Weapons Table**

A detailed tabular listing of common AAMs appears on page 65.

---

---

### Surface-to-Air Missile (SAM) Weapons

System Name	Mounting	Search Guidance	Max Range for Search	Firing Guidance	Max Range for Firing	Max Speed	Max Altitude	Maneuvering
SA-2 Guideline	Unarmored	Poor radar	200 km (3)	Poor radar	125 km (2)	Mach 3+	55,000'	Very poor
SA-5 Gammon	Unarmored	Poor radar	350 km (5.5)	Poor radar	200 km (3)	Mach 3	95,000'	Poor
SA-8B Gecko	AFV	Fair radar	125 km (2)	Fair radar	65 km (1)	Mach 2	25,000'	Good
SA-9B Gaskin	AFV	Visual	65 km (1)	Fair IR	30 km (0.5)	Mach 1.5	20,000'	Very good
SA-10 Grumble	Unarmored	Great radar	350 km (5.5)	Great radar	125 km (2)	Mach 3	70,000'	Average
SA-11 Gadfly	AFV	Fair radar	200 km (3)	Good radar	100 km (1.5)	Mach 2.5	45,000'	Good
SA-12	Unarmored	Good radar	300 km (5)	Great radar	150 km (2.5)	Mach 3+	70,000'	Average
SA-13 Gopher	AFV	Poor radar	125 km (2)	Good IR	65 km (1)	Mach 1.5	20,000'	Very good
SA-N-4	Warship	Good radar	200 km (3)	Fair radar	30 km (0.5)	Mach 2	25,000'	Good
SA-N-5	Warship	Poor radar	varies	Poor IR	30 km (0.5)	Mach 1.5	20,000'	Very good
SA-N-6	Warship	Great radar	350 km (5.5)	Great radar	125 km (2)	Mach 3	70,000'	Average
SA-N-7	Warship	Good radar	200 km (3)	Good radar	100 km (1.5)	Mach 2.5	45,000'	Good
MIM-23B Hawk	Unarmored	Good radar	175 km (3)	Good radar	125 km (2)	Mach 1.5	52,000'	Good
Rapier	Unarmored	Good radar	125 km (2)	Good radar	65 km (1)	Mach 2+	24,000'	Very good
Tigercat	Unarmored	Visual	65 km (1)	Visual	30 km (0.5)	Mach 1.5	12,000'	Good
Seacat	Warship	Poor pulse	200 km (3)	Visual	30 km (0.5)	Mach 1.5	12,000'	Good

---

---

**Systems:** The AIM- series weapons with USA nationality are available to the F-19 and other advanced warplanes of the USA and its current allies. The AIM- series weapons noted as "West" are older models available throughout the Western world, including former US allies such as Iran.

The AA- series weapons are available to the USSR and Eastern nations, such as Libya. Some of these weapons are limited to a specific plane (such as the AA-6 with the MiG-25, or the AA-9 with the MiG-31).

**Guidance:** *Infrared* (IR) homing missiles guide themselves to target. The quality of the IR homing system indicates how well it locks onto front and side aspects, and how hard it is to jam. *Active radar* homing missiles also guide themselves to target. *Semi-active radar* homing missiles require the firing plane to keep it's radar on the target (you), otherwise the missile will miss.

**Effective Range:** At this range the missile can be fired with a good chance of hitting. Note that this range is often less than the theoretical maximum range of the missile found in many reference books.

The AIM-7F Sparrow, used occasionally by Iranian F-4E Phantom II's, is rather inaccurate at any range, while the AA-8 Aphid has a very small warhead.

**Max Speed:** The maximum speed, in Mach (speed of sound) values, is purely approximate.

**Flight Maneuvering:** This is a general measure of how fast the missile turns. Missiles with poor maneuverability are easier to evade.

---

## Air-to-Air Missile (AAM) Weapons

<i>System Name</i>	<i>Nation /plane</i>	<i>Guidance</i>	<i>Effective Range</i>	<i>Max Speed</i>	<i>Flight Maneuvering</i>
AIM-9H Sidewinder	USA	Good Infrared (IR)	11 miles	Mach 3+	Excellent
AIM-120A AMRAAM	USA	Active Radar	18 miles	Mach 4	Very good
AA-2 Atoll	USSR	Poor Infrared (IR)	7 miles	Mach 2.5	Very good
AA-8 Aphid	USSR	Fair Infrared (IR)	6 miles	Mach 3	Excellent
AA-6 Acrid	MiG-25	Semi-active Radar	25 miles	Mach 4	Fair
AA-7 Apex	USSR	Semi-active Radar	17 miles	Mach 3	Average
AA-9	MiG-31	Semi-active Radar	41 miles	Mach 3+	Good
AA-10	USSR	Active Radar	32 miles	Mach 3+	Very good
AIM-9H Sidewinder	West	Fair Infrared (IR)	6 miles	Mach 3+	Excellent
AIM-7F Sparrow	West	Semi-active Radar	32 miles	Mach 4	Very good

---

---

---

---

## IV Regional Briefings

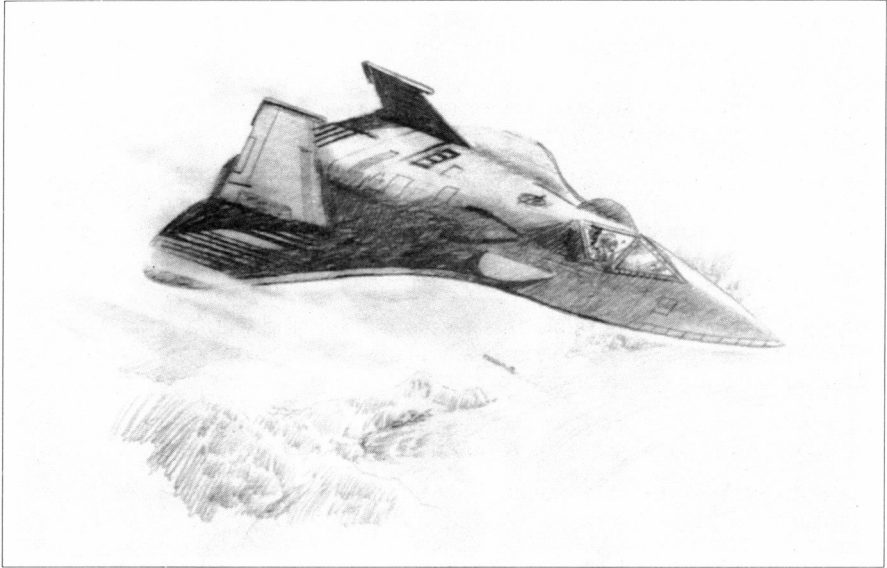

### • ONC Maps •

Four ONC maps are included: Libya, Persian Gulf, North Cape, and Central Europe. These maps all use the standard US Army military grid system for locating positions anywhere on the globe.

The maps are divided into large squares. Each square is identified by a two-letter code, such as WX, JC, etc. Within each square are smaller rows and columns, ruled into smaller squares. These smaller squares are identified by column and row number from 0 to 9. Following the "read right and up" rule, the column number appears first, then the row number. This is the same as basic algebra, where the "x" horizontal value is given first, then the "y" vertical value.

For example, coordinate JC79 means large map square JC, column 7, row 9.

### • Libya Training •

#### Introduction

This region is designed as a USAF computer simulation of Libya. Pilots training for action against Libya routinely use this simulator first. The simulation functions like real life except enemy hits do no damage.

The simulator is a close approximation of Libyan forces and defenses. However,

---

---

---

---

on a real mission the enemy may have SAMs, fighters and warships in other and/or additional positions. Training simulators are never exact duplicates of real life.

For additional details, consult the "Libya" briefing on the following pages.

## Training Options

**Bombing Practice** sends you to the Gulf of Sirte, with no active aircraft or SAM defenses, to practice weapon release runs. Your objective is to destroy the central *oil terminal* at Ras Lanuf (ONC UC83). However, if the enemy is alerted to your presence, active aircraft may appear eventually from the Benina airbase near Benghazi, and/or from the Idris airbase near Tripoli.

**Air-Air Practice** is over Benghazi (ONC VC16) and the Benina airbase (ONC VC15), where a simulated Libyan fighter is on patrol. SAMs are not functional in this area. Your objective is to eliminate the enemy *fighter patrol* airborne over the city.

**Dress Rehearsal** is over Tripoli (ONC TC87), where you must attempt weapons release runs with enemy SAMs firing at you. Also beware of enemy fighter interceptors, including additional interceptors scrambling from the Idris airbase just south of the city. Your objective is to destroy the *HQ (headquarters) bunker* within the city.

## • Libya •

### Introduction

**Politics:** Libya is ruled by Col. Mu'ammar al-Qadhaffi, leader of the secret army organization that deposed the former king in 1969. The capital city is Tripoli and the nation's chief source of wealth is oil sold to western nations.

**Military Forces:** Rich by third world standards, Libya buys most of its armaments from the Soviet Union. Personnel are trained by Soviet military advisors, but national pride has prohibited (so far) any significant Soviet presence. Soviet advisors are not invited on combat operations.

The Libyan Army has approximately 60,000 men, the Navy has over 50 ships and 6,500 men, while the Air Force has about 530 planes, 30 combat helicopters, and 8,500 men. A paramilitary "Pan-African Legion" of about 10,000 also exists.

**Geography:** Libya is a desert nation. Along the coastal region it has only one mountain region that is visually distinctive: the Jabal al Akbar to the east of Benghazi. These mountains greatly restrict the capabilities of Benghazi and Benina radars. Deep in the desert, east of Sabha, are the more desolate and isolated mountains of the Al Haruj al Aswad.

### Level of Conflict

**Cold War:** Libya is the number two backer of international terrorist organizations

---

---

---

---

in the modern world. It provides funds, arms, military training, and base camp sites for a variety of Arab and other terrorist groups. America has already attacked tactical military targets in retaliation for Libya's role in numerous incidents of international terrorism in Europe and the Mediterranean.

**Limited War:** The Libyan army has fought minor border clashes against Egypt to the east. Egypt is an American ally, and so far has proved considerably superior, militarily, to Libya. The Libyan army has also attempted an invasion of Chad to the south. After a protracted campaign against Chad and her ally France, Libyan supply lines through the Sahara desert were cut, forcing a Libyan retreat. Future limited wars between Libya and any of her neighbors are possible.

**Conventional War:** In the event of NATO-Warsaw Pact conflict in the Mediterranean and/or Europe, Libya is expected to provide bases for Soviet aircraft and warships operating in the Mediterranean. These bases would become the westernmost outposts of Russian forces contesting the Mediterranean, making Libya "center stage" for climactic naval battles.

### **Friendly Bases**

**Ragusa on Sicily (ONC UD15):** The USA maintains a military base at Trapani, on western Sicily. It can also stage aircraft through Ragusa in southeastern Sicily. The Ragusa runway could be used for launching and recovering Stealth aircraft missions.

**CV America at Sea (ONC UD70):** This 60,000-ton "Kitty Hawk" class conventional aircraft carrier, designated CV66, often serves with the US 6th Fleet in the Mediterranean. It participated in the 1986 raids against Tripoli and Benghazi. The carrier is ideally positioned for launching and recovering strikes against Benghazi, the Gulf of Sirte, or targets deep in the Libyan desert. Here it cruises on a northerly course with two missile cruisers as close escorts. The carrier remains well north of the Gulf of Sirte to avoid SSM attacks from enemy ships and aircraft.

**Akrotiri on Crete (ONC VD52):** This airfield, near the city of Khania, is not an American base. No mission plans call for launch or recovery here. However, it can be used as an emergency strip. It has the advantage of being both closer and less public than equivalent airfields in Greece or Egypt.

### **Libyan SAM Batteries**

**Search Radars:** The standard SA-2 and SA-5 air defenses are guided by older pulse-type search radars. However, if Russia ships SA-10s or 12s, these systems will include modern doppler radars.

**Tripoli:** East of the city is a major missile complex defending the capital. Until recently, long-range SA-5 Gammons have been sited here. However, in the case of Limited or Conventional War, intelligence is concerned that veteran Russian military advisors may replace these with the formidable SA-12.

**Benghazi-Benina:** This city is the site of Libya's second-largest military base, including the Benina airfield. The SAM battery was recently reported as armed with

---

---

---

---

SA-2 Guidelines. Intelligence estimates that veteran Russian advisors may replace these with SA-5 Gammons in Cold War situations, while at higher levels of conflict SA-10 Grumbles may appear instead.

**Gulf of Sirte:** Between the oil terminals at Ras Lanuf and Port Brega, a military SAM battery guards the Libyan coastline and the Gulf of Sirte. This is an old and second rate battery whose SA-2 Guidelines will probably never be upgraded.

## Naval Forces

The Libyan Navy is primarily composed of Missile Corvettes and Missile Patrol Boats. The largest of these are the 770-ton Russian-built Nanuchka II class armed with Styx surface-to-surface missiles, SA-N-4 surface-to-air missiles, and a twin 57mm gun turret. The other boats include the Russia Osa-class, Italian-built Wadi M'ragh class and the French-built La Combattante II types; these have poorer missiles and SA-N-5 SAMs, or no SAMs at all.

The Nanuchkas are the best boats in the Libyan Navy. They perform the most aggressive patrols, making them the primary threat. Patrols occur frequently in the Gulf of Sirte, south of the "Line of Death." Sometimes the Libyan air force flies fighter missions in support of the patrols.

## Air Forces

**Fighters:** The Libyan Air Force is primarily composed of MiG-23MF "Flogger" fighters, with over 140 craft in inventory. It also has a smaller number of MiG-25 "Foxybats" for reconnaissance and long-range interception, as well as some antiquated MiG-21s. The Air Force also has various Mirage 5D fighter-bombers for ground attack missions.

Intelligence expects that MiG-23s and 25s will be the primary air-to-air opponents, although in a Conventional War situation Russia may ferry in MiG-29 "Fulcrum" fighters flown by veteran Soviet pilots.

**Reconnaissance Bombers:** Although Libya does not possess any Tu-95 "Bear" reconnaissance bombers, Russian planes may periodically operate from Libyan bases.

**Airborne Early Warning & Control:** Libya has no AEW&C craft. No Russian Il-76 "Mainstays" are expected to use Libyan bases, since they are too precious and secret for peacetime use. In wartime Libya is a "front line" region where aircraft losses could be high. Russia would be unwilling to risk losses to the rare and costly AEW&C "Mainstay".

**Air Transports:** It is suspected that Libya's antiquated fleet of C-130H and C-47 air transports (built in America) will be replaced with Russian equipment, perhaps including the new An-72 "Coaler" jet transport.

## Installations of Tactical & Strategic Importance

**Army Headquarters:** This multi-story bunker is located in downtown Tripoli. It

---

---

---

---

frequently serves as a home for Col. Qadhaffi and his family, as well as his seat of government.

**Airbases:** *Idris*, on the southern outskirts of Tripoli, is the largest military airbase as well as providing an international-class civilian airport. *Benina* is the second largest, being a purely military field southeast of Benghazi. Smaller military-civilian fields exist at *Port Brega* and *Sabha*.

**Oil Terminals:** *Ras Lanuf* is Libya's largest and newest oil facility. The majority of all oil for export is stored here. Numerous piers and deepwater oilheads exist for loading regular and "super" tankers. From a military standpoint the central of the three sites is the most vital.

*Port Brega* is Libya's older oil facility, still in operation despite the completion of *Ras Lanuf*. *Brega* has two docks of equal importance. *Tripoli* itself also has an oil terminal, but its dimensions and importance are modest in comparison to *Ras Lanuf* and *Port Brega*.

**Oil Fields:** In the desert regions southeast of the oil terminals are the great oil fields of Libya. The wells of these vastly productive fields are connected by various overland pipes to the oil terminals. The well heads themselves are more valuable than the pipes, especially given the multiple piping connections. The largest and most famous fields are at *Raguba*, *Gialo*, *Amala*, *Waha*, *Jalo Oasis*, and *Sarir*.

## Targets & Ordnance Loading

Below is a list of target assignments and the various types of ordnance that could successfully execute the mission against that target.

Mission Targets:

*Photograph any installation:* 135mm/IR Cameras.

*Destroy oil terminal or oil wells in oil fields:* GBU-12 Paveway, Mk 20 Rockeye, Mk 82-0 Slick, Mk 82-1 Snakeye, Mk 20 Rockeye II, Mk 122 Fireye, Mk 35 In Cluster, ISC B-1 Minelets.

*Sink missile boat:* AGM-88A HARM, AGM-84A Harpoon, Penguin-3 ASM.

*Destroy airbase runway:* Durandal, ISC B-1 Minelets.

*Destroy SAM battery radar bunker:* AGM-88A HARM, AGM-65D Maverick, GBU-12 Paveway, Mk 82-0 Slick, Mk 20 Rockeye II, Mk 122 Fireye, CBU-72 FAE, Mk 35 In Cluster.

*Destroy HQ (headquarters) bunker:* AGM-65D Maverick, GBU-12 Paveway, Mk 122 Fireye, CBU-72 FAE.

*Destroy any aircraft:* AIM-9M Sidewinder, AIM-120A AMRAAM.

Other Targets:

*Destroy airbase control tower:* GBU-12 Paveway, Mk 20 Rockeye, Mk 82-0 Slick,

---

---



---

---

Mk 82-1 Snakeye, Mk 20 Rockeye II, Mk 122 Fireye, Mk 35 In Cluster, ISC B-1 Minelets.

*Destroy SAM missile launcher:* AGM-65D Maverick, Mk 20 Rockeye, Mk 82-0 Slick, Mk 20 Rockeye II, Mk 35 In Cluster, ISC B-1 Minelets.

---

## • The Persian Gulf •

### Introduction

**Politics:** Iran has been ruled by Shi'ite (Moslem) religious radicals since their overthrow of the pro-American Shah in 1979. In September, 1980 Iraq attacked Iran, beginning a long, costly war between those nations. Both contestants are viewed with distrust by the Arab states along the south of the Persian Gulf. Iran's use of international terrorism as a tool of foreign policy has not helped either (Iran is the world's foremost supporter of terrorism).

Iran also calls for a Shi'ite religious revolutionary throughout the Islamic world. This naturally bothers the leadership of the Arab states, since their governments are officially Sunni. However, Iran is populated by Persians, not Arabs. So far this cultural and linguistic barrier has hindered the spread of Iranian Shi'ite radicalism across the Persian Gulf to the Arab states.

**Military Forces:** Under the Shah, Iran's oil-rich finances permitted massive investment in military forces, mostly from the USA. Since the revolution many complex weapons have failed for lack of spare parts and maintenance, while most of the rest were damaged or destroyed in the war with Iraq. Iran has some sophisticated aircraft and missiles remaining, but these are deployed to protect key cities on the interior, rather than as a border defense.

**Geography:** Iran is a large nation with varied geography. The Elbruz and Zagros mountain ranges run from the northwest corner (where Iran touches Turkey and the Soviet trans-Caucasus) diagonally southeast, along the border with Iraq, and then parallel to the Persian Gulf. South of these mountains, at the head of the Gulf, are Iran's oilfields. North of the mountains the nation is divided into two regions. The western part, near Iraq, Turkey, and trans-Caucasus Russia, is fertile, heavily populated, and includes most of the major cities and industrial plants. The eastern part, bordering Pakistan, Afghanistan, and Soviet Central Asia, is mostly barren deserts and mountains with a small, impoverished, undereducated population.

### Level of Conflict

**Cold War:** Iran's use of terrorism has been very effective to date. America's confused policy response, culminating in the Iran-Conra scandal, is one example. However, eventually the continued violence will provoke an a military response from the Western nations.

**Limited War:** Iran and Iraq have been fighting a limited war since 1980. The

---

---

---

---

cities of Abadan and Basra, on the national border where the Tigris-Euphrates rivers empty into the Gulf, are largely ruined by the fighting. Running northward are two opposing lines of trenches and bunkers with a “no-man’s land” between.

Each side has attempted to discourage Persian Gulf shipping from aiding the opposition, resulting in missile and rocket attacks on many freighters and tankers. As American fleet escort operations in late 1987 demonstrate, it’s easy to get involved in the fighting.

**Conventional War:** Russia could invade Iran as part of a wider NATO-Warsaw Pact conflict, or as a counter to the Shi’ite radicals. America may be drawn into invading Iran by its confused foreign policy. The vast and often hostile geography, not to mention a large and hostile population, argue against traditional military invasions. Instead, a gradual escalation from limited war, including bigger and deeper air attacks, are more probable .

## **Friendly Bases**

**Kuwait City in Kuwait (ONC JZ12):** Although studiously neutral in the past, Iranian attacks on Kuwait have caused that nation to seek US military aid and support. The Kuwait airport could be used to occasionally stage a mission that demonstrated America’s support to Kuwait.

**Ras as Saffaniyah (ONC JY29):** This is Saudi Arabia’s northernmost oil terminal and port along the Gulf. Its airfield is in a useful strategic location. Basing privileges for a secret “stealth” mission can be arranged with the pro-American Saudi monarchy.

**Dhahram (ONC JY55) & Al Hufuf (ONC JY44):** Dhahram is Saudi Arabia’s largest port city on the Persian Gulf, making its airfield an unwise choice for stealth aircraft operations. However, the Al Hufuf airfield slightly inland is a strategically useful and less public position for basing missions and raids.

**As Salamiyah (ONC JY01):** This small airbase outside of the capital Riyadh is a nice, quiet location where clandestine missions can be organized easily.

**Bahrain (ONC JY65):** This small island nation is strongly pro-American, providing large naval and air base facilities for American military forces. It is fairly easy to operate stealth missions from here.

**Ruweiss (ONC JY91) & Tarif (ONC KY11):** These small, western oil ports of the United Arab Emirates are primarily emergency landing bases. However, in circumstances of need, America could pressure the UAE to permit a launch or recovery, especially in these relatively remote locations.

**Abu Dhabi (ONC KY32):** Political considerations restrict the use of this international airfield to emergency landings only. Abu Dhabi is the major city of the United Arab Emirates (UAE), where the appearance of neutrality is most important.

**Al Khafi at Dubai (ONC KY54):** This large airfield, outside the city of Dubai, is the most strategically useful of all UAE airfields. It is the base closest to south-central Iran, and as such an important launching or retrieval point for deep

---

---

---

---

missions. However, political considerations and difficulties greatly restrict the use of this field.

**Muscat in Oman (ONC KY90):** Oman is careful to remain neutral in all affairs, but is strongly pro-western. For example, much of its army is trained and officered by "retired" British military personnel. The military portion of the Muscat airfield is available for missions, provided everything remains secret.

**The American Fleet:** Aircraft carriers and their close escorts remain in the Indian Ocean, where they can sail into launching range or retreat far out to sea, as circumstances require. Only smaller ships (frigates, destroyers and sometimes a cruiser) venture into the Persian Gulf itself. As a result, Arabian land airbases must be the final launching point for stealth missions across the Persian Gulf into Iran.

### **Iranian SAM Batteries**

**Equipment:** HAWK batteries are Iran's longest ranged surface-to-air missiles. Nearly exhausted in fighting with Iraq, these weapons are formidable defenders of Iran once more. The reason is the shipment of parts and spare missiles by Colonel Oliver North, USMC. Think about that every time one fires at you!

Rapier batteries, sold by Britain to Iran, are nearly as good as the HAWK, but have a shorter range. They too use modern doppler radars.

The Tigercat, an antiquated British design with pulse search radars appear in less-important areas. The Seacat is a naval version of the Tigercat, found on Iranian Vosper Mk 5 type frigates.

**Defended Areas:** The Harun highlands (in the Ahvaz-Masjed Soleyman-Dezful triangle), Bushehr overlooking Kharg Island, Esfahan, and Bandar 'Abbas (the main military complex on the Straits of Hormuz) all have HAWK missiles.

The main airbase at Shiraz and the nearly front-line city of Bandar Khomeyni may have Rapiers, HAWKs, or Tigercats, depending on current resources and the level of fighting. Bandar-e Lengeh (at the western end of the Straits of Hormuz), Yazd, and the troops along the Iran-Iraq front line are expected to have the lowest grade SAMs, generally Tigercats.

### **Iranian Naval Forces**

The Iranian Navy has suffered greatly in the Iran-Iraq war, since most resources go into the army and air force. Many ships were damaged in the fighting and remain unrepaired, others have deteriorated badly for lack of maintenance. The great naval base at Khorramshahr, near Abadan, was destroyed early in the war and remains a no-man's land.

It is known that at least one of the four Vosper Mark 5 frigates is still functional. These 1,100-ton ships include an SSM surface-to-surface missile, Seacat SAM surface-to-air missiles, and a 4.5" gun turret. Occasional patrols by these or smaller ships can be expected in the region of Kharg Island or in the Straits of

---

---

Hormuz. If functional, the Vosper frigates pose a significant military threat.

## Iranian Air Force

This service arm is composed primarily of American-built aircraft acquired during the Shah's rule. Before the outbreak of the Iran-Iraq war the Air Force had a nominal strength of 75 F-14 Tomcats, about 200 F-4D and F-4E Phantom IIs, 140 F-5E Tiger IIs, and various transport and reconnaissance planes and helicopters, including C-130 Hercules transports and P-3F Orion reconnaissance bombers.

**Fighters:** Iran lacks the sophisticated technicians and parts to keep its F-14s operational. Within a year after the revolution fewer than five were believed functional. Today none are flyable. The inferior F-4s and F-5s are easier to maintain. They continue to attempt sorties against Iraq, intercept Iraqi air-raids, and frighten enemy-bound shipping in the Straits of Hormuz.

These fighters are equipped with AIM-9H Sidewinders, shorter range and less accurate than the new AIM-9M available to the F-19. The F-4E Phantom jets are equipped to carry the AIM-7F Sparrow, a longer-ranged radar-homing missile. The less sophisticated F-5E Tigers cannot use the complex Sparrows.

**Reconnaissance Bombers:** Iran has few P-3 "Orion" naval reconnaissance bombers purchased from the USA during the Shah's reign. Some of these are still flying, although their electronic equipment is probably not fully functional. A variety of smaller, informal patrol planes are also used, including lighter planes that double as air transports.

**Airborne Early Warning & Control:** Iran has no "AWACS" or other AEW&C aircraft. No Russian planes of this type currently operate in the Persian Gulf, and none are expected in the immediate future.

**Air Transports:** Iran has a variety of small, medium and large air transports, including the American C-130 Hercules, German Fokker F.27, French Dassault-Breguet Falcon 20, and Boeing 707 and 747 transport models. The exact types available vary greatly, depending on the supply of spare parts and the presence of knowledgeable mechanics.

## Installations of Tactical & Strategic Importance

**Main Air Force Base & Southern Military Headquarters:** These are found in Shiraz, housed in large buildings, not bunkers. Therefore bunker-busting weapons useful in Libya are of no use here. Be advised and select your ordnance accordingly.

**Airbases:** *Shiraz* has the largest Iranian military airbase and remains the central headquarters of the Iranian Air Force in the south, including aircraft involved in the Iraq war and Persian Gulf operations. The cities of *Esfahan*, *Yazd*, *Kerman*, *Bandar 'Abbas* and *Bushehr* also have significant airbases capable of military operations. Cities near the Iraq war border have been subjected to artillery and/or air attacks. Their airbase facilities are largely destroyed or abandoned. This is certainly true of *Dezful* and *Ahvaz*, but runways at *Masjed Soleyman* and *Bandar*

---

---

---

---

*Khomeyni* still may be operational. It is possible for planes to operate from *Bandar-e Lengeh*, but this is considered unlikely as long as the much larger Bandar 'Abbas base remains operational only 100 miles away.

**Oil Terminals:** *Kharg Island* was Iran's great oil terminal, designed for convenient refining, storage and loading of oil from the large fields north of Bushehr, as well as from offshore platforms. However, the Island has been repeatedly raided by Iraqi planes, leaving the facilities partly functional at best. In response, Iran is constructing an overland pipe toward ports further south in the Gulf, out of range of Iraqi raids.

**Oil Fields:** The oil fields of Iran are located somewhat north of Bushehr (in ONC JZ72), and are among the richest in the world. Some offshore oil platforms exist in the vicinity of *Kharg Island*.

## **Targets & Ordnance Loading**

Below is a list of target assignments and the various types of bay ordnance that could successfully execute the mission against that target.

Mission Targets:

*Photograph any installation:* 135mm/IR Cameras.

*Destroy oil terminal or oil wells in oil fields:* GBU-12 Paveway, Mk 20 Rockeye, Mk 82-0 Slick, Mk 82-1 Snakeye, Mk 20 Rockeye II, Mk 122 Fireye, Mk 35 In Cluster, ISC B-1 Minelets.

*Sink warship:* AGM-88A HARM, AGM-84A Harpoon, Penguin-3 ASM.

*Destroy airbase runway:* Durandal, ISC B-1 Minelets.

*Destroy SAM site (Bandar Komeyni, Shiraz or Yazd only):* AGM-65D Maverick, Mk 20 Rockeye, Mk 82-0 Slick, Mk 20 Rockeye II, Mk 35 In Cluster, ISC B-1 Minelets.

*Destroy SAM battery radar bunker:* AGM-88A HARM, AGM-65D Maverick, GBU-12 Paveway, Mk 82-0 Slick, Mk 20 Rockeye II, Mk 122 Fireye, CBU-72 FAE, Mk 35 In Cluster.

*Destroy HQ (headquarters) building:* GBU-12 Paveway, Mk 20 Rockeye, Mk 82-0 Slick, Mk 82-1 Snakeye, Mk 20 Rockeye II, Mk 122 Fireye, Mk 35 In Cluster, ISC B-1 Minelets.

*Destroy any aircraft:* AIM-9M Sidewinder, AIM-120A AMRAAM.

Other Targets:

*Destroy airbase control tower:* GBU-12 Paveway, Mk 20 Rockeye, Mk 82-0 Slick, Mk 82-1 Snakeye, Mk 20 Rockeye II, Mk 122 Fireye, Mk 35 In Cluster, ISC B-1 Minelets.

*Destroy SAM missile launcher (other locations):* AGM-65D Maverick, Mk 20 Rockeye, Mk 82-0 Slick, Mk 20 Rockeye II, Mk 35 In Cluster, ISC B-1 Minelets.

---

---

---

---

## • NORTH CAPE •

### Introduction

**Politics:** The North Cape area is shared by four nations. West to east, they are Norway, Sweden, Finland, and the Soviet Union. Their political orientations parallel their geographic locations: Norway belongs to NATO, Sweden is a pro-Western neutral, neutral Finland accomodates the Soviets. The Soviet Union, of course, is the leader of the Eastern Bloc.

**Military Forces:** In terms of global politics, the North Cape is the single most important piece of military real estate in the Soviet Union. Murmansk is Russia's only year-round open-sea access to the Atlantic ocean. Russian SSBNs (ballistic missile nuclear submarines), the heart of nuclear deterrence, sail from here into the Atlantic and Arctic oceans. The Soviet Northern Fleet protects these invaluable weapons, as well as maintaining a credible threat to NATO's Atlantic lifelines.

The Northern Fleet includes, roughly, one aircraft carrier, 75 other major surface warships, one marine brigade, 133 submarines, and 446 naval aircraft. The protection of its bases is the duty of 12 Divisions of army troops (about 300,000 men total) and 150 planes of Frontal Aviation (air force planes supporting the army) and the PVO (air force interceptors guarding the border).

Norway fields a large, tough force tailored for a dogged defense of its mountainous homeland. Reasonably well-equipped, the majority of the forces guard the populous southern regions, but northern bases are garrisoned too. In addition, NATO troops are earmarked to aid Norway in time of war.

Sweden's armed forces are designed to make the Russians (or anyone) think twice about violating that country's neutrality. These forces are well equipped. However, the northern part of Sweden is almost unpopulated, so the defenses are considerably lighter. A low-visibility plane such as the F-19 would have little trouble sneaking through.

Finland fields a much smaller and less sophisticated force than its neighbors. Although fiercely independent, Finland has learned to accomodate the desires of its powerful neighbor. Even if Finland could detect F-19 overflights in its northern regions, it's unclear whether it would bother informing it's neighbor immediately.

**Geography:** This entire region is a harshly cold climate. Northern Norway is a long, mountainous country with a harsh climate and "iron" (rocky) seacoast. In this terrain a small group of determined defenders could stop an army for years. The "open" areas of Finland and Sweden are deceptive. On the map it may appear to be an open plain, perfect for attack. In reality it's a frigid wilderness in the winter and a vast, marshy bog in the summer.

### Level of Conflict

**Cold War:** Because of the potential threat posed by the Northern Fleet's ships

---

---

---

---

and aircraft to the shipping lanes in the Atlantic, NATO and Russian forces are constantly sparring with each other, testing the other's responses and jockeying for position should hostilities break out. Officially at peace, the two sides wage a covert conflict of intelligence gathering and military posturing.

**Limited War:** If Russian or American foreign policy was conducted with greater hostility, the North Cape would be an ideal place for Western raids or retaliations against the Soviets. Similarly, their air and sea defenses could get excessively "trigger happy" and shoot before asking questions. Even among men of good faith, there is always a temptation to send in a secret mission to "take out" something that really bothers you. For example, Israel has done this from time to time.

**Conventional War:** The balloon's gone up. NATO and the Warsaw Pact are officially shooting at each other in this part of Europe (perhaps elsewhere too). The Northern Fleet is making a sortie into the Atlantic, Soviet troops have crossed the border into Norway, Mainstays and MiGs are clouding the skies. Now missions are no joke at all. Getting in and out with your skin intact will be very, very tricky!

## Friendly Bases

**Bardu (ONC WX21):** The main Norwegian base in the Northern Region, Bardu is a main staging area for US NATO warplanes, as well as a base for any limited or covert commitment.

**Banak (ONC WX44):** Smaller than Bardu, Banak is the military airfield closest to the sealanes the Northern Fleet would use if moving against Norway or into the Atlantic.

**Kautokeino (ONC WX61):** Kautokeino is the major inland airfield. It is closest to Murmansk and the Kola peninsula, and therefore would serve as the jumping-off point for missions deep into the Kola Peninsula.

**Lakselv (ONC WX94):** Lakselv is not a military airfield. However, because of its proximity to the Soviet positions, it could be used to stage deep reconnaissance probes in peacetime, or quick strikes in wartime. It is always available as an emergency strip after a particularly rough mission.

**Lulea (ONC WW33):** The main Swedish military base in the Northern Region, Lulea is not normally available to NATO forces. Nevertheless, relations between Sweden and the USSR are often strained. Sweden might cooperate with NATO, especially if the mission remained secret and the aircraft was virtually invisible.

## Russian SAM Batteries

The Kola peninsula is vital to the Soviet Union because of the access it affords to NATO's lines of communications, but its very proximity also makes it particularly vulnerable to NATO counterstrokes. Consequently, the Kola peninsula is likely to prove one of the most challenging anti-aircraft environments in the world today.

**Light SAMs:** For point defense against air attack the Soviets have a variety of SAMs mounted on armored fighting vehicles. These include the IR SA-9 and SA-

---

---

---

---

13, and the radar-guided SA-8 and SA-11. All are a serious hazard to low-level flight, especially in the region between Norway and Murmansk.

**Long Range SAMs:** These are area defense weapons that, along with fighters, are your primary opposition. One major battery is located near the port and airfield at *Kem*; another protects the critical rail-junction and logistical base at *Kandalaksha*; two more are stationed to protect the naval installations around *Murmansk*. All are armed with powerful missiles. Green opponents typically use the older SA-5s, Regulars and Veterans commonly have SA-10s and SA-12s.

**Other Radars:** In addition to the radars specifically associated with SAM systems, you may also be spotted by airport control tower radars. These are quite inferior in quality, but just may register your plane if you pass nearby. Of course, sometimes the operators are asleep, and won't see you even if you pass overhead (or assume you're Soviet, or whatever other rationalization they select to continue with their nap).

## Naval Forces

Russia's Northern Fleet offers both tempting targets and a significant threat. Its modern Sovremennyy-class destroyers carry SA-N-7 missiles. The larger Kiev-class carrier has the long-ranged SA-N-6, the sea-going equivalent to the SA-10. These warships are more than capable of defending themselves. Stationed off the northern coast, they significantly extend the Soviet anti-aircraft umbrella.

In addition to these ships' SAMs, the Kiev carries a complement of Yak-38 "jump-jet" fighter aircraft. While they are less capable aircraft than ground-based fighters, the British Harriers in the Falklands taught the world not to underestimate the capabilities of such planes.

## Air Forces

**Fighters:** If you're facing green air defenses, they may rely on the Northern Fleet air arm to have planes operational, so the prime opponent is probably the Yak-38. However, regular or veteran Air Force staffs will insure, despite frigid conditions, that the MiGs and Sukhois will be operational. You may encounter PVO MiG-25 or MiG-31 long-range interceptors with long-range radar AAMs, or frontal aviation MiG-29 and Su-27 dogfighters with shorter range radar and IR missiles.

**Reconnaissance Bombers:** Many long-range Tu-95D "Bears" are based in this area, to keep tabs on NATO naval activity in the North Atlantic. A nuisance in peacetime, these planes pose a serious threat in a war. Eliminating these craft is always a high priority in NATO war plans. Eliminating the "Bears" effectively blinds the Russian high command to activities in the Atlantic and Norwegian seas.

**Transports:** Russia possesses numerous air transports for its huge force of airborne units. The most modern of these is the jet propelled An-72 "Coaler," which is particularly suited to fast, high priority missions like inserting commando teams or transporting critical command personnel.

**AEW&C Aircraft:** The Soviets routinely deploy Il-76 "Mainstay" aircraft in this

---

---



---

---

region. The 300+ mile radars on this plane may be your most formidable enemy. If you're spotted and can't discover how or by whom, chances are it's a Mainstay.

## Installations of Tactical & Strategic Importance

**Northern Fleet Headquarters:** The Northern Fleet's command center is in Severomorsk, near Murmansk. Although considerable administration occurs in unfortified buildings, the vital personnel and communications facilities are protected in hardened bunker-like shelters.

**Airbases:** The Kola peninsula contains many important military airfields. The principal ones are *Pechenga*, *Polyarnyy*, *Kilpyaur*, *Kildenstroy*, *Olengorsk*, and *Monchegorsk*. *Pechenga* and *Polyarnyy* serve both as advanced bases near Norway and as a first line of defense for Murmansk. *Kilpyaur* and *Kildenstroy* guard Murmansk closer in, while *Olengorsk* and *Monchegorsk* lie further to the south. In addition, there is an airfield south of the Kola peninsula at *Kem*.

**Depots:** The Kola peninsula contains substantial logistical facilities to support the naval, air, and ground forces stationed there. The primary facilities are located at *Murmansk*, but a second substantial site is believed to exist at *Kandalaksha*, where the constricted lines of ground communication up the western coast of the White Sea broaden out to the northeast and northwest.

**LPAR Radar:** The Soviet Union deploys an extensive network of Large Phased-Array Radars (LPAR) that provide almost complete coverage of the air and space approaches. These are ostensibly for early-warning purposes, but could be quickly integrated into an Anti-Ballistic Missile (ABM) system, despite treaties to the contrary. Surveillance of these facilities is critical in peacetime, and their destruction could be vital in wartime.

**Submarine Pens:** The Soviet force of ballistic missile submarines is based here. At any given time part of the force is at sea, acting as nuclear deterrent, while the remainder is refitting here at the pens. Northern Fleet anti-ship missile and attack submarines also use this base recessed into a sea-side cliff. In wartime this base is a target of the utmost importance.

## Targets & Ordnance Loading

Below is a list of target assignments and the various types of ordnance that could successfully execute the mission against that target.

Mission Targets:

*Photograph any installation:* 135mm/IR Cameras.

*Sink warship:* AGM-88A HARM, AGM-84A Harpoon, Penguin-3 ASM.

*Destroy airbase runway:* Durandal, ISC B-1 Minelets.

*Destroy SAM battery radar bunker (SA-5,-10,-12):* AGM-88A HARM, AGM-65D Maverick, GBU-12 Paveway, Mk 82-0 Slick, Mk 20 Rockeye II, Mk 122 Fireye, CBU-72 FAE, Mk 35 In Cluster.

---

---

---

---

*Destroy HQ (headquarters) bunker:* AGM-65D Maverick, GBU-12 Paveway, Mk 122 Fireye, CBU-72 FAE.

*Destroy Depot:* GBU-12 Paveway, Mk 20 Rockeye, Mk 82-0 Slick, Mk 82-1 Snakeye, Mk 20 Rockeye II, Mk 122 Fireye, Mk 35 In Cluster, ISC B-1 Minelets.

*Destroy LPAR radar:* AGM-65D Maverick, GBU-12 Paveway, Mk 122 Fireye, CBU-72 FAE, AGM-88A HARM.

*Destroy Subpens:* CBU-72 FAE.

*Destroy any aircraft:* AIM-9M Sidewinder, AIM-120A AMRAAM.

Other Targets:

*Destroy airbase control tower:* GBU-12 Paveway, Mk 20 Rockeye, Mk 82-0 Slick, Mk 82-1 Snakeye, Mk 20 Rockeye II, Mk 122 Fireye, Mk 35 In Cluster, ISC B-1 Minelets.

*Destroy fixed SAM missile launcher (SA-5,-10,-12):* AGM-65D Maverick, Mk 20 Rockeye, Mk 82-0 Slick, Mk 20 Rockeye II, Mk 35 In Cluster, ISC B-1 Minelets.

*Destroy mobile SAM AFVs (SA-8,-9,-11,-13):* AGM-65D Maverick, GBU-12 Paveway, Mk 122 Fireye, CBU-72 FAE.

---

---

## • Central Europe •

### Introduction

**Politics:** Central Europe is where the full force of East and West meet. Since World War II Europe has been divided between two hostile blocs, with a few neutrals precariously balanced between. On one side are the communist East European nations, created in the wake of Soviet armies at the end of WWII. On the other side are democratic Western European nations, created by the USA and Britain in the wake of *their* armies during WWII. Since 1949 the West has been linked by NATO. In 1955 the East formalized an equivalent organization, the Warsaw Pact, dominated by the USSR. From then until now the two greatest military organizations on earth have uneasily eyed each other.

**Military Forces:** The Warsaw Pact can deploy almost three million men, about 80,000 armored fighting vehicles, and 6,000 combat aircraft. Against this juggernaut, the Western powers can field around two million men, 40,000 AFV's, and 4,000 combat aircraft. The numerical imbalance is partially offset by the higher quality of the Western troops and equipment, presumably along with the traditional advantages of being the defender.

Together, the two sides have almost ten thousand nuclear weapons for battlefield use in Europe. These range from small, sub-kiloton shells designed to wipe out troop concentrations to multi-megaton city busters. Artillery, planes, and missiles of all types and ranges can deliver these weapons. At one time NATO felt it had to use nuclear weapons to compensate for numerical inferiority. Today it has an

---

---

---

---

alternative plan: "Air-land battle, 2000." In this NATO uses superior technology, including its Stealth planes, to attack deep in the rear of the Warsaw Pact armies, destroying their logistical support. If this innovative strategy works NATO need not use nuclear weapons to stem the Red tide. However, if this fails, NATO must choose between a nuclear holocaust and the conquest of Europe by the USSR.

**Geography:** The "Central Front" stretches 1000 kilometers through the middle of Germany, bordered on the north by the North Sea and Baltic Sea, and on the south by the Alps. The initial strategic objective of a Russian invasion would almost certainly be crossing the Rhine river, only 150 kilometers from the frontier (at the closest point). West German terrain is mildly favorable to the defender, especially in the forested and hilly southern half. The broad, flat North German Plain is the traditional invasion route. But today it is so densely settled that every few kilometers is a town, village, or city that could become a new defensive bastion.

One often neglected geographic consideration is the terrain to the *east* of the frontier. With the development of the "Air-land battle" this region takes on a new significance. The North German plain broadens toward the east, encompassing most of East Germany and Poland. It is crossed by a number of major rivers flowing northward, channeling road and rail traffic into a variety of bridges. This combination of open countryside and numerous "choke points" is well suited to air operations.

## Level of Conflict

**Cold War:** This is the situation of the last 40 years. The two sides maintain a wary posture, generally trying to avoid overt provocations, probing each other to gain information, stir discontent in the enemy population, and gain psychological advantages. The Stealth fighter, designed for clandestine penetration, is the perfect aircraft for the secret operations common in this situation.

**Limited War:** Now the conflict is at the brink of open warfare, but armies have not yet crossed any borders. As military acts escalate, the opportunity for stealth missions increases as well. Military actions are political signals that urge the other to back away in forceful terms. Unfortunately, sometimes fighting just escalates. This technique was successful for America on Grenada and against Libya, but it failed in Vietnam. Well, you're just a Stealth pilot, carrying out orders.

**Conventional War:** This is it! Russian tanks pour over the West German border while NATO forces scramble to stem the onrushing tide. On one side lies conventional defeat, on the other the disaster of thermonuclear war. "Air-land battle, 2000" goes into effect. Stealth aircraft, airmobile raiding groups, and long range "smart" munitions make the dangerous crossing over the front to hammer Soviet rear echelons. If they can isolate the Russian spearheads from their base, they may give the politicians an opportunity to avert disaster.

## Friendly Bases

West Germany, Holland, and Denmark are studded with airfields that could serve

---

---

---

---

as bases for Stealth raids into Eastern Europe. They form a gentle, north-south crescent bulging west in the middle. Which is the most suitable starting point for a particular airstrike depends mainly on the location of the target. However, the Stealth fighter's unique characteristics will be most effective in the areas only thinly covered by radar to the north and south of the main arena. Therefore, deep penetration raids will usually start from Denmark or Southern Germany. Shorter tactical strikes, however, must fly directly into the mouth of the tiger.

## **Soviet SAM Batteries**

**Equipment:** Since the "Central Front" forms the focal point of the war, the anti-aircraft defenses on both sides are the most intensive in the world. The Soviets are certain to deploy large quantities of their most modern weapons, SA-10s and -12s for area defense, with -11s and -13s for point defense of important targets. Some older -5s, -8s, and -9s may still be around if the Soviets are not on a wartime footing or using green troops. But however you slice it, this is very dangerous airspace indeed!

**Defended Areas:** The whole region is alive with lethal metal. The areas immediately behind the central portion of the front lines are the most intensively defended. The extreme northern and southern flanks will be less densely covered. The deep areas over Poland may be slightly easier to handle. But don't get cocky just because you make it past the front. These are relative assessments, not absolute. Let down your guard, and your aircraft will undoubtedly follow.

## **Soviet Air Force**

The Soviet Air Force is the largest in the world, and one of the most modern. It deploys a wide variety of interceptor, bomber, and support aircraft. Some are obsolescent, but many can meet the best of the West. The Soviets know the value of air superiority. They'll give high priority to the air battle in Europe.

**Fighters:** As always, the primary foe is another pilot. With 6,000 combat aircraft to chose from, you can bet that the Red Air Force will find a few to spare for you. They'll also have the hot new models. If you're lucky, you'll only run into MiG-23's, but more likely you'll encounter MiG-29's and Su-27's, or perhaps some rear area interceptors like the MiG-25 and MiG-31.

**Bombers:** The Russians have a number of bomber aircraft. Although the F-19 isn't really an interceptor, the Russians may put high-endurance cruise-missile carriers into orbit deep behind their lines, protected by SAMs and fighters. Getting this plane, the Tu-95 "Bear" H, would take a stealth mission.

**Airborne Early Warning & Control:** The Soviet "Mainstay" AEW&C can be found flying "racetrack" orbits deep behind their lines, watching NATO air operations with their radars. These valuable planes will naturally be sitting on top of the biggest SAM concentrations with plenty of fighter escort. Mainstays may be a nuisance to you, but they're flying death to the rest of the NATO air arm. The only way to get them is to sneak up on them - with a Stealth Fighter!

**Transports:** Thousands of air transports will be shuttling back and forth on both

---

---

---

---

sides of the front line, carrying troops, raiding parties, munitions, staff officers, etc. The new workhorse that flies anywhere and carries almost anything is the An-72 "Coaler". Its high speed and short-field capability make it the natural choice for secretive missions, and a natural target for Stealth Fighter missions.

## Installations of Tactical & Strategic Importance

**Western TVD Headquarters:** One of the salient lessons of the Vietnam War was the importance of disrupting enemy command, control, and communications. Any offensive against NATO's Central Front will be coordinated by the headquarters of the Western Theatre of Operations (Western TVD in Soviet parlance). The precise location is unknown, but once pinpointed it will be a prime target for a sneak airstrike.

**Airbases:** East Germany and Western Poland are awash in military airfields, which menace both NATO aircraft and ground forces. Putting them out of action, at least temporarily, will help those hard-pressed grunts below, not to mention aiding deep strikes by other Stealth and conventional strike aircraft.

**Depots:** A heavily armored army like the Russia's has an umbilical cord of unarmored trucks, unfortified facilities, and unprepared personnel trailing off to the rear. These are the prime targets in "Air-land 2000". Bombing depots and supply dumps is a prime activity of the Stealth aircraft on the Central Front. Destroying depots may not be as glamorous as dogfighting or tank busting, but in the end it may prove far more decisive.

**OTH Radar:** Long-range phased array over-the-horizon radar is a powerful tool for watching what's happening 600 to 1,000 miles behind enemy lines. It is believed the Soviets are constructing a facility of this type. In peacetime it's important to keep an eye on it, in wartime its elimination is a strategic priority.

## Targets & Ordnance Loading

Below is a list of target assignments and the various types of ordnance that could successfully execute the mission against that target.

Mission Targets:

*Photograph any installation:* 135mm/IR Cameras.

*Destroy airbase runway:* Durandal, ISC B-1 Minelets.

*Destroy SAM battery radar bunker (SA-5,-10,-12):* AGM-88A HARM, AGM-65D Maverick, GBU-12 Paveway, Mk 82-0 Slick, Mk 20 Rockeye II, Mk 122 Fireye, CBU-72 FAE, Mk 35 In Cluster.

*Destroy HQ (headquarters) bunker:* AGM-65D Maverick, GBU-12 Paveway, Mk 122 Fireye, CBU-72 FAE.

*Destroy Depot:* GBU-12 Paveway, Mk 20 Rockeye, Mk 82-0 Slick, Mk 82-1 Snakeye, Mk 20 Rockeye II, Mk 122 Fireye, Mk 35 In Cluster, ISC B-1 Minelets.

---

---

---

---

*Destroy OTH radar:* AGM-65D Maverick, GBU-12 Paveway, Mk 122 Fireye, CBU-72 FAE, AGM-88A HARM.

*Destroy any aircraft:* AIM-9M Sidewinder, AIM-120A AMRAAM.

Other Targets:

*Destroy airbase control tower:* GBU-12 Paveway, Mk 20 Rockeye, Mk 82-0 Slick, Mk 82-1 Snakeye, Mk 20 Rockeye II, Mk 122 Fireye, Mk 35 In Cluster, ISC B-1 Minelets.

*Destroy fixed SAM missile launcher (SA-5,-10,-12) :* AGM-65D Maverick, Mk 20 Rockeye, Mk 82-0 Slick, Mk 20 Rockeye II, Mk 35 In Cluster, ISC B-1 Minelets.

*Destroy mobile SAM AFVs (SA-8,-9,-11,-13):* AGM-65D Maverick, GBU-12 Paveway, Mk 122 Fireye, CBU-72 FAE.

---

---

## V Common Military Aircraft

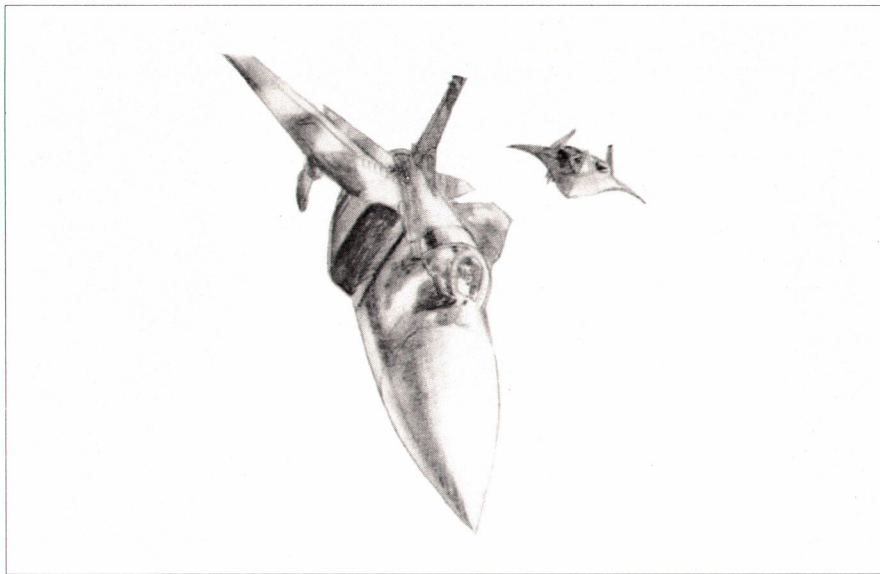

### • Key to Aircraft Statistics •

During a Stealth combat mission, you could encounter a variety of Russian-built craft, not to mention the American F-4 Phantoms and and F-5 Tigers flown by the Iranian Air Force. Information about aircraft is organized as follows:

**Role:** A “fighter” plane specializes in air-to-air combat, where the objective is destroying enemy aircraft. An “interceptor” is a fighter designed to fly long distances and attack distant enemy aircraft. A “strike” plane is designed to hit surface targets in enemy territory. “Close support” strikes are against enemy front-line troops, “interdiction” strikes are against military rear areas (head-quarters, supply dumps, columns on roads, etc.), while “deep strikes” attack enemy installations far behind the front line (railroad yards, bridges, airbases, etc.). Strike aircraft designed to attack warships are sometimes termed “attack” planes. “Bombers” are designed for interdiction, deep strike, and/or naval attack, as well as carrying nuclear weapons for strategic (nuclear war) missions.

**Crew:** If a plane has a crew of one man, cockpit aids are important. The workload for one man in a jet warplane is quite high.

**Mission Weight:** This is the typical total weight of the plane, with fuel and weapons, at takeoff. If the plane can serve in both fighter and strike role, the fighter (air-to-air) weight is given. In a strike role a plane often carries 15-35% additional weight.

---

---

**Engines:** The total thrust of the engines (on afterburners if available) is important. Airplanes with greater thrust than weight can fly "ballistically", a useful advantage in air combat. A high thrust-weight ratio is desired by all fighter pilots.

**Range:** This is the combat radius of the plane when loaded for action, but using only internal tanks (no extra fuel tanks). Often the figure is an approximation.

**Ceiling:** Maximum altitude of the plane, using afterburners if available.

**Maximum Speed at 0':** Sea-level maximum speed is often much less than high altitude maximum speed, especially in high-speed jets.

**Maximum Speed at 36,000':** Above this altitude Mach 1 is a constant 573 knots. However, the optimum turning speed for most aircraft is Mach 0.75 to 0.90 (i.e., 550-650 knots, depending on the plane and altitude); higher speeds are only good for chasing opponents, escaping from them, or quick dashes into and out of enemy airspace.

**Armament:** Often weapons pylons can be fitted to carry multiple bombs or lightweight missiles. The number of pylons need not limit the number of ordnance items.

**Air-Air Radar Quality:** As a stealth aircraft, you are naturally interested in the range and quality of enemy airborne search radar.

**Maneuverability:** This is a comparative rating of how well the plane can maneuver in a dogfight. All aircraft are rated on the same standard: the superb maneuverability of the F-16 Falcon.

---

## • American-Built Warplanes •

### F-4E Phantom II

*Designer/Manufacturer:* McDonnell Douglas, USA

*Role:* Fighter & strike fighter

*Crew:* Two

*Mission Weight at Takeoff:* 27 tons

*Engine(s):* Two General Electric J79-17 turbojets for 35,800 lbs thrust

*Range:* 520 miles

*Ceiling:* 58,750'

*Maximum Speed at 0':* 800 kts

*Maximum Speed at 36,000':* 1260 kts

*Armament:* 6-barrel 20mm cannon, 4 missile recesses, 5 weapon pylons

*Air-Air Radar Quality:* Fair quality and range pulse radar

*Maneuverability:* Fair to good

This all-purpose plane served the US Navy and Air Force as both a fighter and a strike fighter throughout the 1960s and early 1970s. In the USAF it is now obsolescent, serving mainly for reconnaissance and electronic warfare ("Wild Weasel"). However, hundreds were sold to western nations worldwide, including Iran under the Shah. For air-to-air combat the plane can carry four AIM-9 Sidewinders and four AIM-7 Sparrows.

---

---



F-4E Phantom II

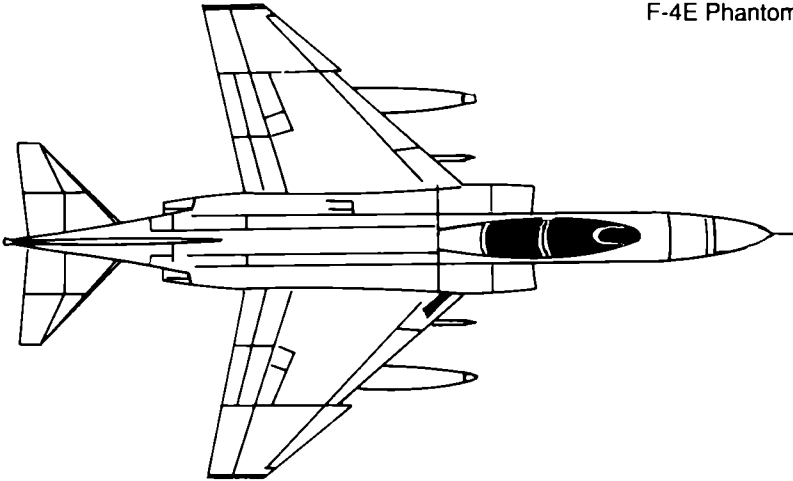

F-5E Tiger II

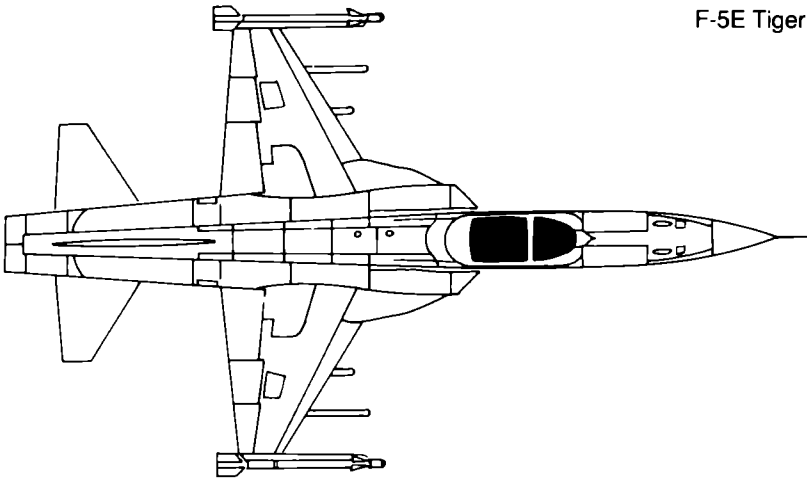

**F-5E Tiger II**

*Designer/Manufacturer:* Northrop, USA

*Role:* Fighter & strike fighter

*Crew:* One

*Mission Weight at Takeoff:* 12 tons

*Engine(s):* Two General Electric J85-GE-21B turbojets for 10,000 lbs thrust

*Range:* 138 miles

---

---

*Ceiling:* 51,000'

*Maximum Speed at 0':* Not listed, probably 500-600 kts

*Maximum Speed at 36,000':* 950 kts

*Armament:* Two 20mm cannon, 5 weapon pylons

*Air-Air Radar Quality:* Poor quality and range pulse radar

*Maneuverability:* Fair

This inexpensive and unsophisticated fighter was never adopted by US combat arms, but has been widely sold abroad, including 138 to Iran. Underpowered, with poor avionics, it is useful only against obsolete opponents. It can carry AIM-9 Sidewinders, but not AIM-7 Sparrows.

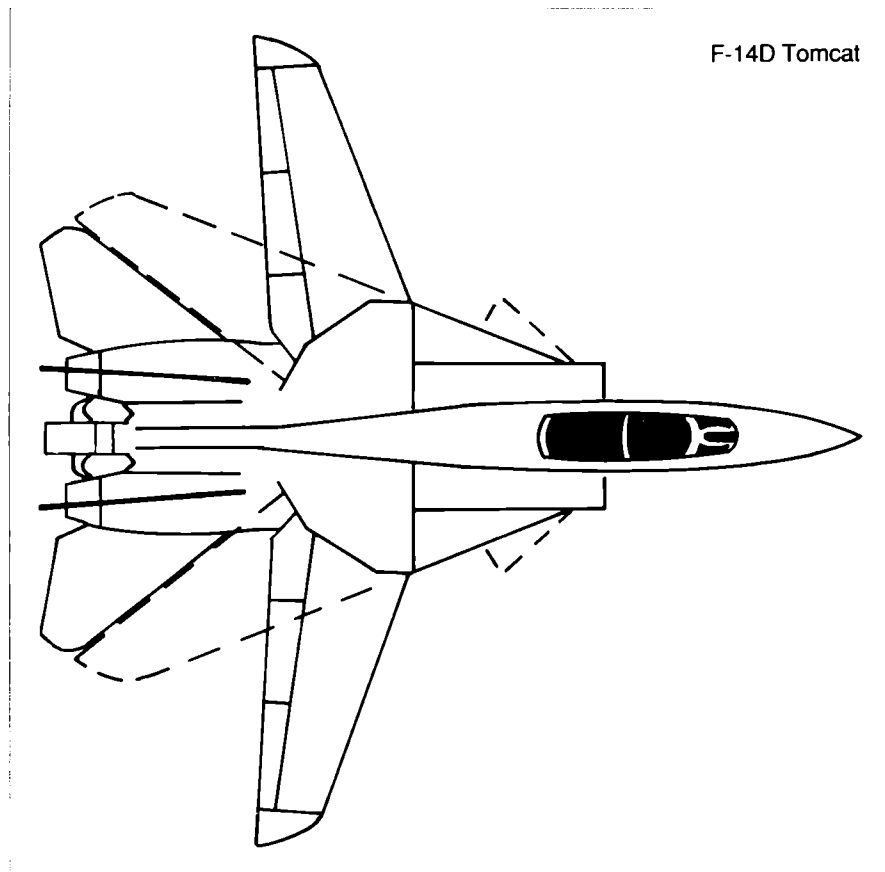

### **F-14D Tomcat**

*Designer/Manufacturer:* Grumman, USA

*Role:* Fighter & interceptor

*Crew:* Two

*Mission Weight at Takeoff:* 35 tons

---

---

---

---

*Engine(s)*: originally two Pratt & Whitney TF30-412A turbofans for 41,800 lbs thrust, upgraded in D model to two General Electric F110-400 turbofans for 54,000 to 58,000 lbs thrust

*Range*: 800 miles

*Ceiling*: over 56,000'

*Maximum Speed at 0'*: 800 kts with TF30, higher with F110

*Maximum Speed at 36,10'*: 1350 kts with TF30, higher with F110

*Armament*: 6-barrel 20mm cannon, 4 weapons pallets, 2 weapons pylons

*Air-Air Radar Quality*: Excellent range, high quality doppler radar

*Maneuverability*: Good

This heavy, long-range interceptor has extremely powerful avionics for use with the AIM-54 Phoenix semi-active radar-homing missile, which has a 125 mile effective range. The aircraft is the US Navy's long-range defender of carrier battle groups. Standard USN armament is four Phoenix and four Sidewinder missiles (two per pylon). The swinging wings are computer controlled for maximum performance, but their swing also show the plane's energy state to the enemy. In 1987 the Navy began a program that upgraded the original TF30 engines with the newer, more powerful F110's. About 80 TF30-engined F14s were supplied to Iran, but engine troubles, complexities in the avionics system, and the delicacy of the Phoenix missiles have rendered all militarily useless.

---

F-15C Eagle

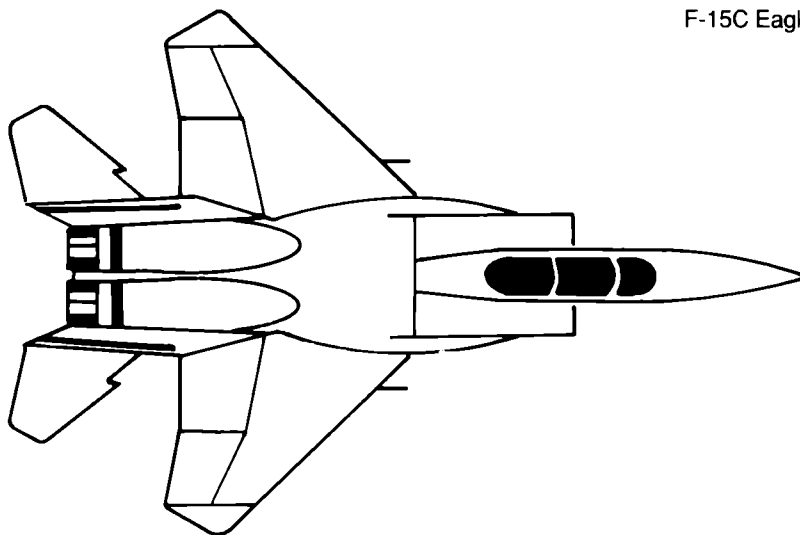

---

### **F-15C Eagle**

*Designer/Manufacturer*: McDonnell Douglas, USA

*Role*: Fighter

*Crew*: One

*Mission Weight at Takeoff*: 22 tons

---

---

---

---

*Engine(s):* Two Pratt & Whitney F100-100 turbofans for 47,660 lbs thrust

*Range:* 750 miles

*Ceiling:* 63,000'

*Maximum Speed at 0':* 810 kts

*Maximum Speed at 36,000':* 1260 kts or greater

*Armament:* 6-barrel 20mm cannon, 4 missile ejectors, 4 weapons pylons, 2 FAST pallet points

*Air-Air Radar Quality:* Medium range, high quality doppler radar

*Maneuverability:* Very good

This large, powerful dogfighter is the dream plane of many USAF pilots. Although not as nimble as the lightweight F-16, it has longer ranged avionics, plus a brute size and power unmatched by any fighter until the new Russian Su-27 appeared.

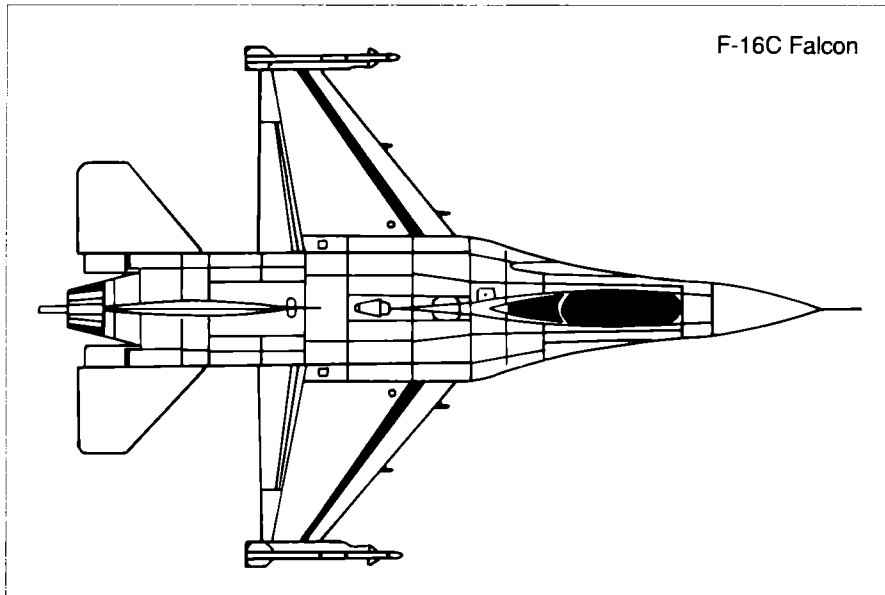

### **F-16C Falcon**

*Designer/Manufacturer:* General Dynamics, USA

*Role:* Fighter & strike fighter

*Crew:* One Pratt & Whitney F100-200 turbofan for 23,830 lbs thrust

*Mission Weight at Takeoff:* 12.5 tons

*Engine(s):* One

*Range:* 340 miles

*Ceiling:* over 50,000'

*Maximum Speed at 0':* 800 kts

*Maximum Speed at 36,000':* 1190 kts

*Armament:* 6-barrel 20mm cannon, 7 weapon pylons

*Air-Air Radar Quality:* Medium range, high quality doppler radar

*Maneuverability:* Excellent

---

---

---

---

The latest production fighter added to the US Air Force, the F-16 is the most maneuverable dogfighter in the world (possibly excepting the MiG-29). The inherently unstable airframe that gives this ability would be uncontrollable except for the computerized electronic controls, hence its nickname "Electric Jet". The plane is also remarkably accurate in a strike role. Advanced avionics and defenses are all "extras", making the basic aircraft relatively cheap. Many western nations have purchased F-16s. However, until the AIM-120 AMRAAM it had no long-range AAM.

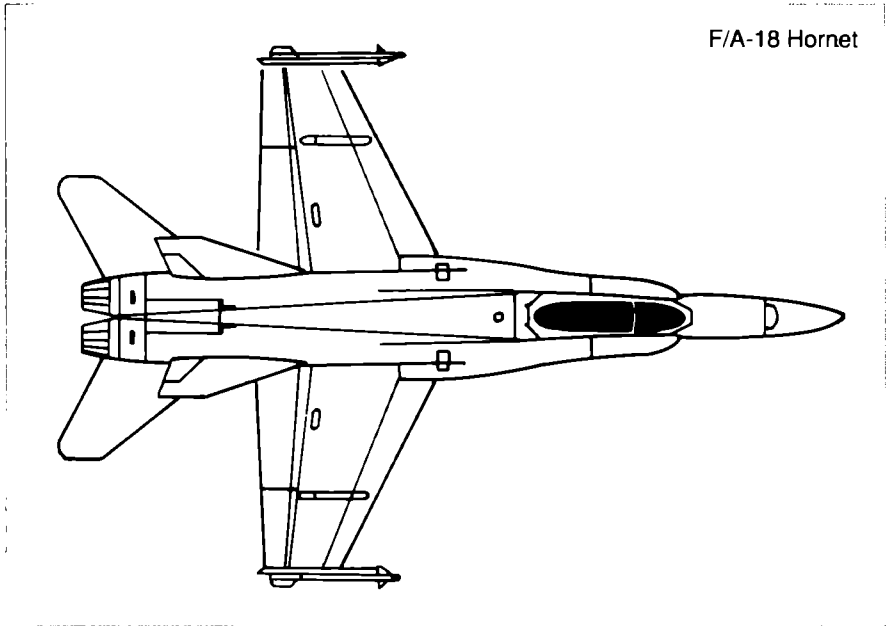

### **F/A-18A Hornet**

*Designer/Manufacturer:* McDonnell Douglas/Northrop, USA

*Role:* Fighter & strike fighter

*Crew:* One

*Mission Weight at Takeoff:* 18 tons

*Engine(s):* Two General Electric F404-400 turbofans for 32,000 lbs thrust

*Range:* 461 miles

*Ceiling:* 50,000'

*Maximum Speed at 0':* Less than 660 kts

*Maximum Speed at 36,000':* 1050 kts

*Armament:* 6-barrel 20mm cannon, 9 weapons pylons

*Air-Air Radar Quality:* Medium range, high quality doppler radar

*Maneuverability:* Good to very good

Although not as maneuverable as the F-16, this heavier multi-role fighter has numerous avionic and defensive aids built in. These were required by the US Navy, its main user, who needed an all-purpose fighter and attack bomber able to fire a

---

---

---

---

variety of sophisticated weapons. Like the F-16, it also has been sold to various western nations.

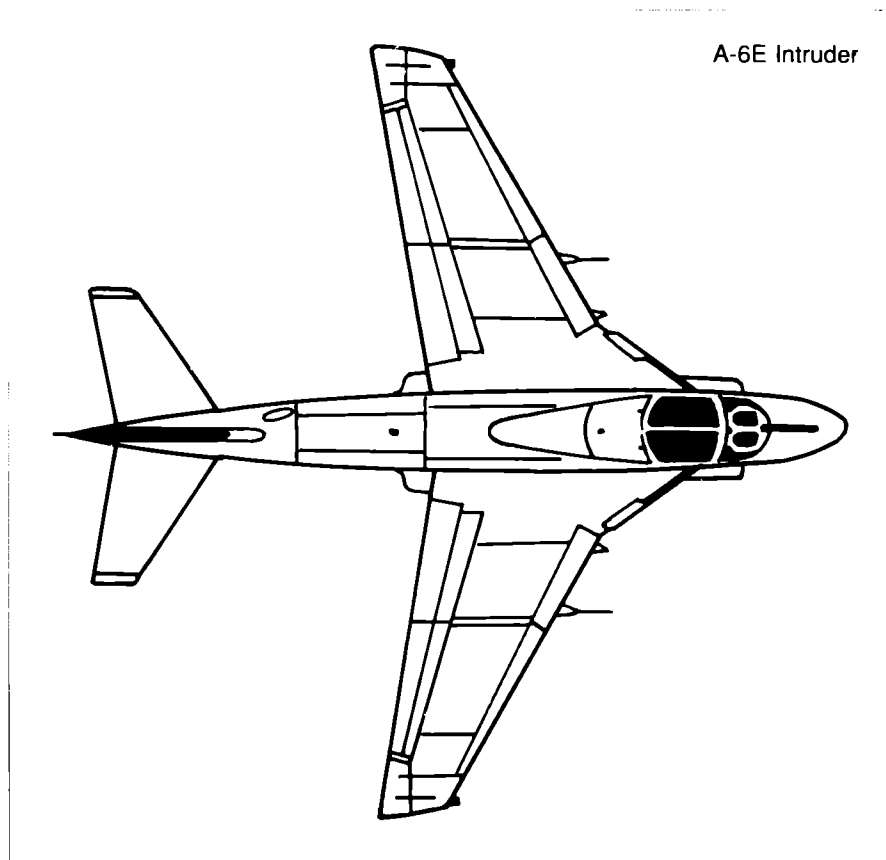

### **A-6E Intruder**

*Designer/Manufacturer:* Grumman, USA

*Role:* Attack & interdiction bomber

*Crew:* Two

*Mission Weight at Takeoff:* 13 tons

*Engine(s):* Two Pratt & Whitney J52-8A turbojets for 18,600 lbs thrust

*Range:* 540 miles

*Ceiling:* 44,600'

*Maximum Speed at 0':* 570 kts

*Maximum Speed at 36,000':* 540 kts

*Armament:* 5 weapons pylons

*Air-Air Radar Quality:* Poor, but superb air-ground weapons radars

*Maneuverability:* Fair to poor

---

---

Designed at the end of the 1950's as a low-level attack bomber for use in bad weather or at night, this plane remains an unqualified success. Avionics and weapons have been rebuilt more than once to maintain the "state of the art", with upgrades under development. Electronic warfare (EA-6 and EA-6B) and aerial tanker (KA-6D) versions exist.

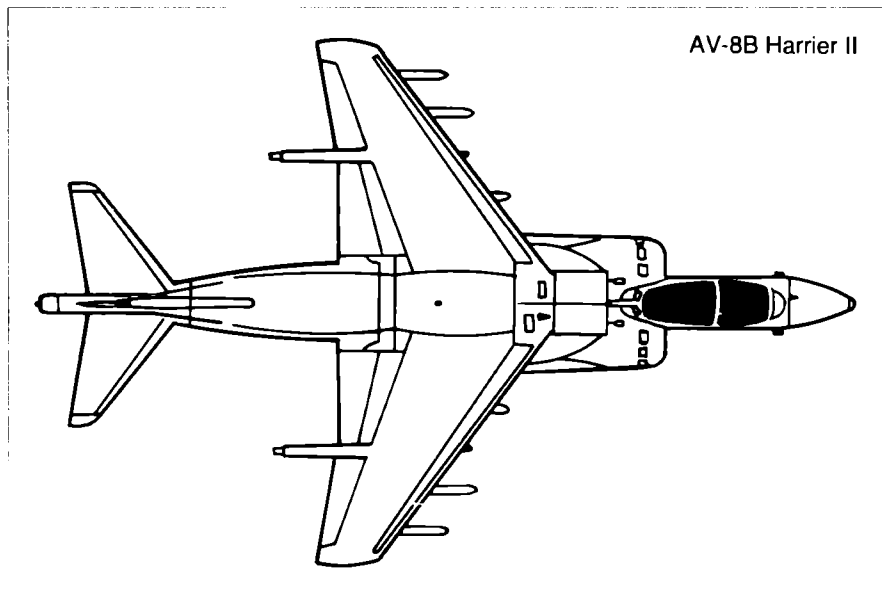

### **AV-8B Harrier II**

*Designer/Manufacturer:* British Aerospace, UK (original design) and McDonnell Douglas, USA (American version)

*Role:* S/VTOL Fighter & strike fighter

*Crew:* One

*Mission Weight at Takeoff:* 15 tons STOVL, 10 tons VTOL

*Engine(s):* One Rolls Royce/Pegasus 11-21E for 22,000 lbs vectored thrust (no afterburner)

*Range:* 150 miles

*Ceiling:* 55,000'

*Maximum Speed at 0':* 585 kts

*Maximum Speed at 36,000':* 520 kts

*Armament:* one 25mm cannon, 7 weapon pylons

*Air-Air Radar Quality:* Poor, target acquisition is usually visual

*Maneuverability:* Very good

Originally designed as a strike fighter, the American-British co-redesign greatly enhanced maneuverability. The avionics are designed for ground attack rather than air-to-air combat. Despite this, Harriers were successful as interceptors and combat air patrol in the 1982 Falklands war. The Harrier is the primary fighter of the US Marines, the British Royal Navy, and frontline squadrons of the British Royal

---

---

---

---

Air Force (RAF) in Germany. Usually it uses short segments of roadway or a "ski-jump" deck for rolling takeoffs, and later lands vertically, like a helicopter.

A-10A Thunderbolt II

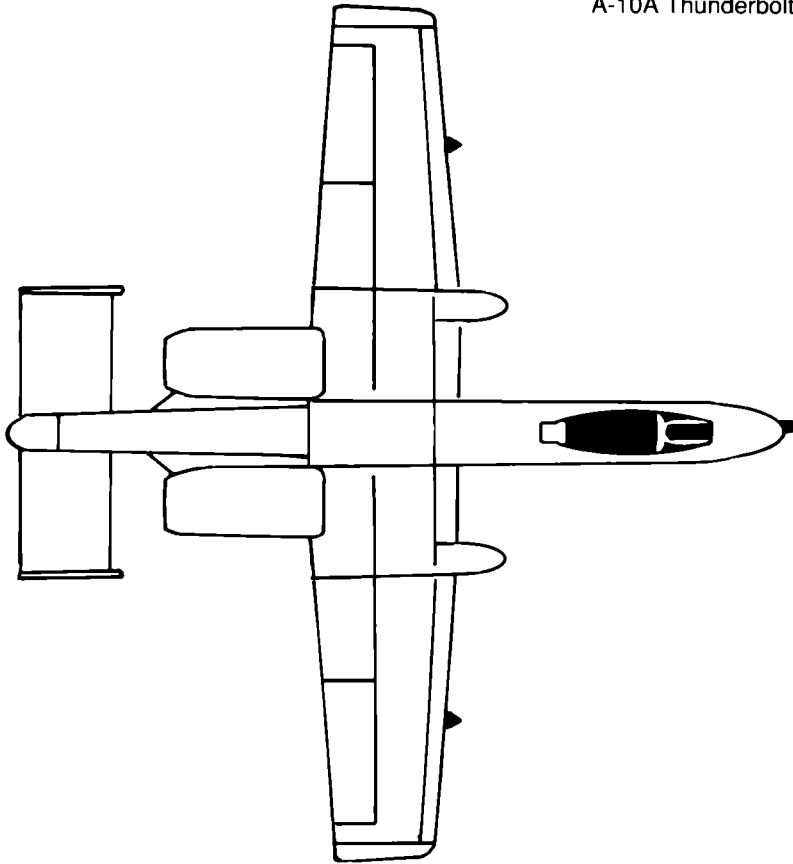

**A-10A Thunderbolt II**

*Designer/Manufacturer:* Fairchild Republic, USA

*Role:* Close support aircraft

*Crew:* One

*Mission Weight at Takeoff:* 20 tons

*Engine(s):* Two General Electric TF34-100 turbofans for 18,130 lbs thrust

*Range:* 600 miles

*Ceiling:* probably under 40,000'

*Maximum Speed at 0':* 370 kts

*Maximum Speed at 36,000':* Unknown, probably less than 370 kts

---

---



---

*Armament:* 7-barrel 30mm cannon, 11 weapon pylons  
*Air-Air Radar Quality:* Poor, air-ground avionics quite basic  
*Maneuverability:* Very good

This slow, heavily armored plane was designed purely for frontline ground attack with "tank busting" its speciality. This role (unglamorous to the USAF) along with its peculiar appearance, earns it the unofficial nickname "Warthog". Although intended for combat in Europe where low clouds and bad weather are frequent, the A-10 is a fair-weather day-only plane. The manufacturer hopes to interest the USAF in a night-flying variant, currently without success. Unless protected by good fighters (F-15s and F-16s), this plane is doomed if sent into airspace contested by USSR fighters.

EF-111A Raven

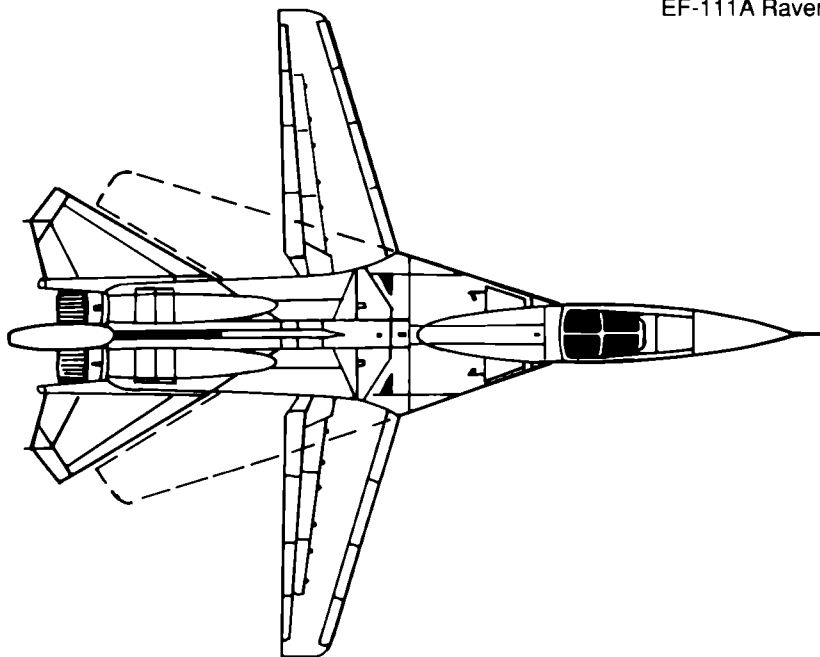

### **EF-111A Raven**

*Designer/Manufacturer:* General Dynamics, USA

*Role:* Electronic warfare escort

*Crew:* Two

*Mission Weight at Takeoff:* 43.5 tons

*Engine(s):* Two Pratt & Whitney TF30-3 turbofans for 37,000 lbs thrust

*Range:* 1,200 miles

*Ceiling:* 54,700'

*Maximum Speed at 0':* 700 kts

---

---

---

*Maximum Speed at 36,000':* 1020 kts

*Armament:* ALQ-99E electronic warfare system, no other weapons

*Air-Air Radar Quality:* Medium-long range, high quality pulse & doppler

*Maneuverability:* Fair

This is a specially built electronic warfare version of the F-111 strike and interdiction bomber. The original concept of the F-111 was a high-speed bomber for deep strikes at high and/or low altitude, especially at night or in bad weather. The EF-111 is popularly known as the "Electric Fox" or "Spark Vark" (the unofficial nickname of the F-111 is "Aardvark" or "Vark"). It is designed to accompany deep strike and interdiction missions, providing electronic screening and jamming. It is the fastest, most powerful such craft in the world.

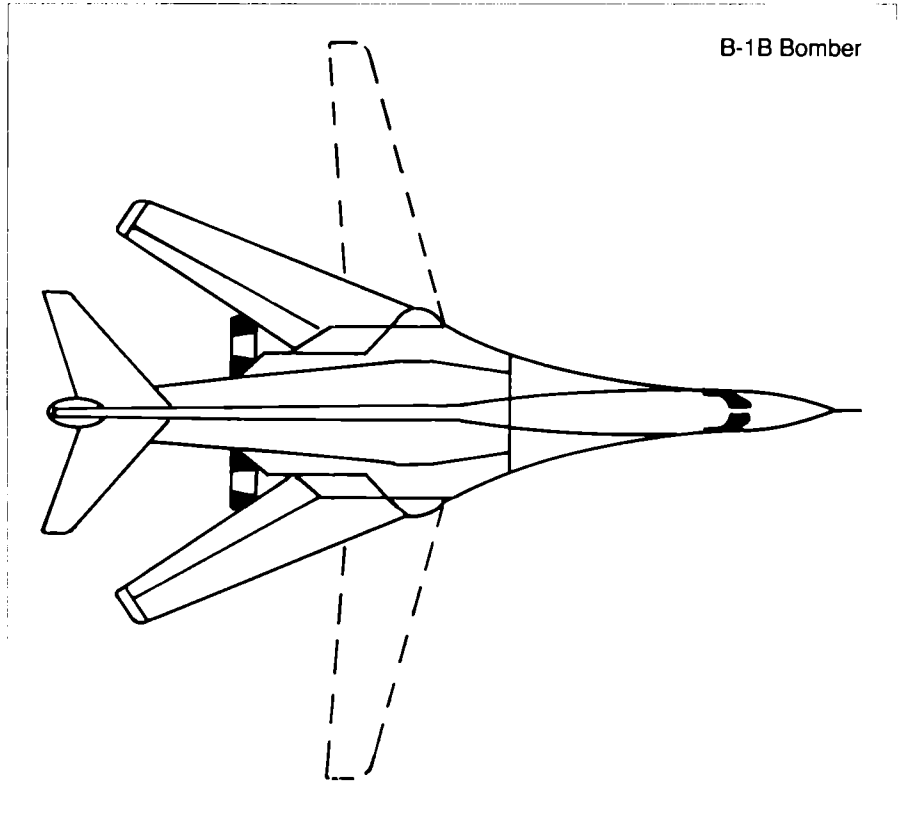

---

---

### **B-1B Bomber**

*Designer/Manufacturer:* Rockwell International, USA

*Role:* Strategic bomber

*Crew:* Four

*Mission Weight at Takeoff:* 225 tons with internal load only

*Engine(s):* Four General Electric F101-102 turbofans for 120 lbs thrust

---

---

---

---

*Range:* 3,700 miles

*Ceiling:* Unknown, probably under 50,000'

*Maximum Speed at 0':* 530 kts

*Maximum Speed at 36,000':* 725 kts

*Armament:* 37.5 ton capacity bomb bay, 29.5 tons additional on external mounts if desired

*Air-Air Radar Quality:* Medium range, high quality doppler radar

*Maneuverability:* Poor

This redesign of the B-1A (cancelled in the late 1960s) emphasizes low-level attack and minimal radar signature. The aircraft is now seriously overloaded by the numerous revisions, and is still waiting for some of its electronic defensive gear. Despite the usual carping from the US press, in combat against first-line Russian aircraft this bomber has some hope of survival. The obsolescent B-52's it replaces would have no chance whatsoever.

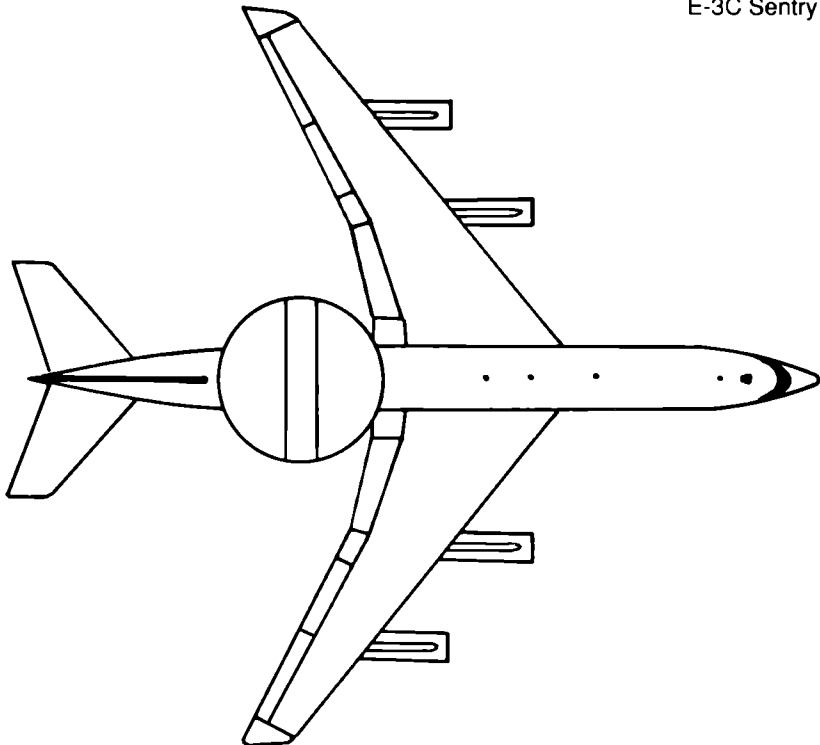

E-3C Sentry

### **E-3C Sentry "AWACS"**

*Designer/Manufacturer:* Boeing, USA

*Role:* Airborne Early Warning & Control

---

---

---

---

*Crew:* 15 to 17

*Mission Weight at Takeoff:* 162.5 tons

*Engine(s):* Four Pratt & Whitney TF33-100/100A turbfans for 84,000 lbs thrust

*Range:* 1,925 miles (11 hours unrefueled endurance)

*Ceiling:* over 29,000'

*Cruise Speed at Altitude:* over 350 kts

*Maximum Speed at Altitude:* 460 kts

*Armament:* Surveillance radar, communications, air traffic control, and electronic defenses; weapons pylons may be added.

*Air-Air Radar Quality:* Excellent range and quality radars.

*Maneuverability:* Poor

This 707 airliner frame holds the most sophisticated and effective airborne radars in the world. No other nation has a plane of equivalent effectiveness (the British Nimrod and Russian Moss are failures, the new Russian Mainstay is still unproven). Flying "racetrack" circles behind friendly lines at 25-30,000', this AWACS can watch and direct aircraft out to 300 miles range. Until the "C" model upgrade, too many aircraft and limited computer power caused temporary "blind spots". In wartime weapons pylons carrying AIM-9 Sidewinders or AIM-120 AMRAAMs could be added. In addition each Sentry carries various electronic defenses and always has a fighter escort.

---

## • Russian-Built Warplanes •

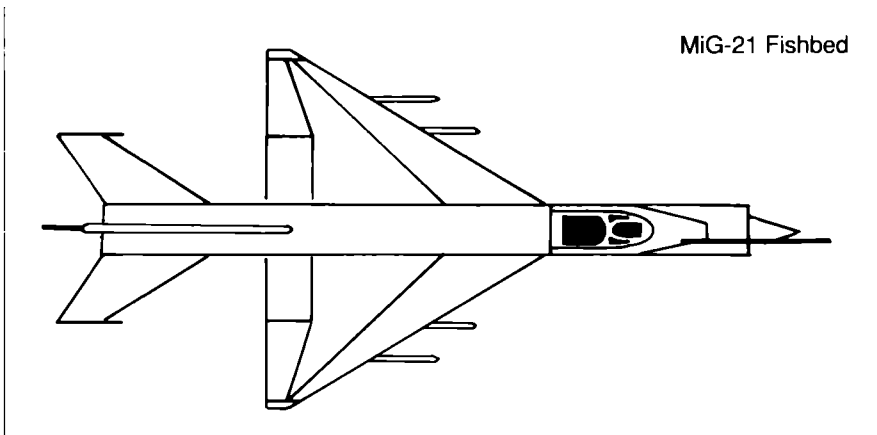

### **MiG-21 Fishbed**

*Designer/Manufacturer:* Mikoyan-Gurevich, USSR

*Role:* Fighter

*Crew:* one

*Mission Weight at Takeoff:* 9 tons

*Engine(s):* One Tumansky R-11F2S-300 turbofan for 14,550 lbs thrust

*Range:* 395 miles

---

---

---

---

*Ceiling:* 59,000' (often only 50,000')

*Maximum Speed at 0':* 700 kts

*Maximum Speed at 36,000':* 1220 kts

*Armament:* Two 23mm cannon, 4 weapons pylons, 1 fuel tank pylon

*Air-Air Radar Quality:* Very short range, low quality pulse radar

*Maneuverability:* Good

This agile, maneuverable, easy-flying fighter was the premier dogfighting plane of the 1960s and early 1970s. It has simple avionics and a standard armament of 2 or 4 AA-2s (now often replaced by AA-8's), making it inexpensive to buy, arm and maintain. However, it has little or no HUD, weak radars, and low quality defenses, making it obsolete as a fighter. Unfortunately, it's limited carrying capacity makes it poor as a strike fighter.

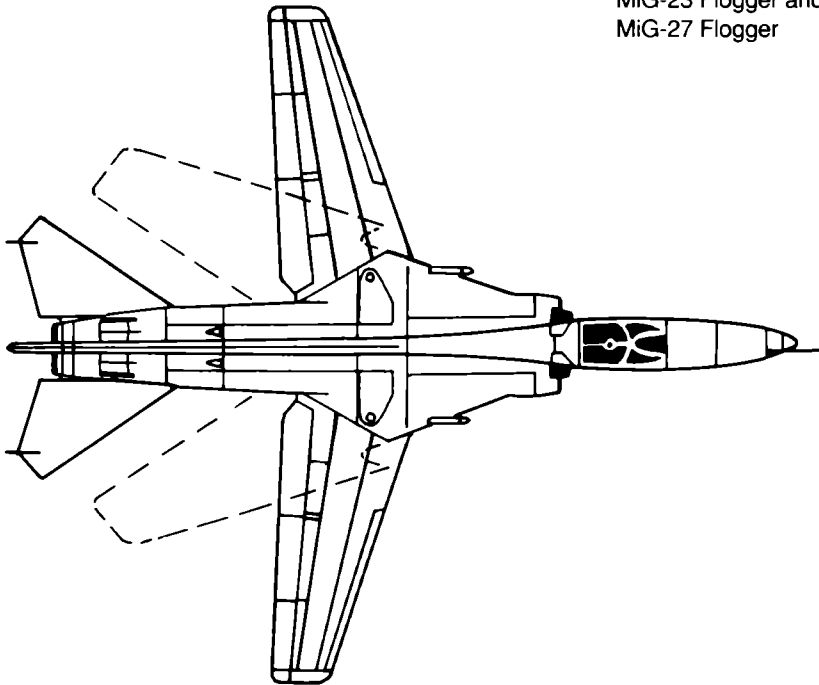

MiG-23 Flogger and  
MiG-27 Flogger

### **MiG-23 Flogger**

*Designer/Manufacturer:* Mikoyan-Gurevich, USSR

*Role:* Fighter

*Crew:* One

*Mission Weight at Takeoff:* 16 tons

*Engine(s):* One Tumansky R-29B turbofan for 27,500 lbs thrust

*Range:* 560 miles

---

---

---

---

*Ceiling:* 61,000'  
*Maximum Speed at 0':* 740 kts  
*Maximum Speed at 36,000':* 1190 kts  
*Armament:* Two 23mm cannon, 4 weapon pylons, 1 fuel tank pylon  
*Air-Air Radar Quality:* Very poor, short range range pulse radar  
*Maneuverability:* Fair

This swing-wing fighter replacement for the MiG-21 originally had few avionics and a 22,485 lb. R-27 engine. This variant, incapable of firing sophisticated weapons and with serious performance flaws, is often sold abroad. The more advanced models, listed above, are mediocre performers. All commonly carry AA-2 and/or AA-8 missiles. With its MiG-27 brother, this plane has huge production runs, making it the cheapest fighter available today. This alone makes it one of the world's most popular aircraft.

### **MiG-27 Flogger**

[Physical appearance equivalent to MiG-23]

*Designer/Manufacturer:* Mikoyan-Gurevich, USSR  
*Role:* Strike Fighter  
*Crew:* One  
*Mission Weight at Takeoff:* 22 tons  
*Engine(s):* One Tumanski R-29 turbofan for 25,353 lbs thrust  
*Range:* 240 miles  
*Ceiling:* 52,500'  
*Maximum Speed at 0':* 635 kts  
*Maximum Speed at 36,000':* 925 kts  
*Armament:* One 6-barrel 23mm cannon, 5 weapon pylons, 2 bomb racks  
*Air-Air Radar Quality:* Very poor, very short range pulse radar  
*Maneuverability:* Fair

This is the ground-attack variant of the MiG-23. In Russian frontline units it includes a laser designator for laser-guided munitions and simple terrain-avoidance radars for low-level attacks. Improved jammers and decoys are added as well. However, many sophisticated attack aids common on western strike fighters are not present. Presumably the MiG-27s compensate for this with quantity, as huge production runs greatly lower its cost.

### **MiG-25 Foxbat**

*Designer/Manufacturer:* Mikoyan-Gurevich, USSR  
*Role:* PVO Interceptor  
*Crew:* One  
*Mission Weight at Takeoff:* 40 tons  
*Engine(s):* Two Tumansky R-31 turbofans for 48,500 lbs thrust  
*Range:* 700 miles  
*Ceiling:* 80,000'  
*Maximum Speed at 0':* 570 kts  
*Maximum Speed at 36,000':* 1860 kts  
*Armament:* 4 weapons pylons  
*Air-Air Radar Quality:* Medium quality, medium range pulse radar  
*Maneuverability:* Poor

This plane is designed purely to defend the distant borders of the USSR from air

---

---

---

---

MiG-25 Foxbat

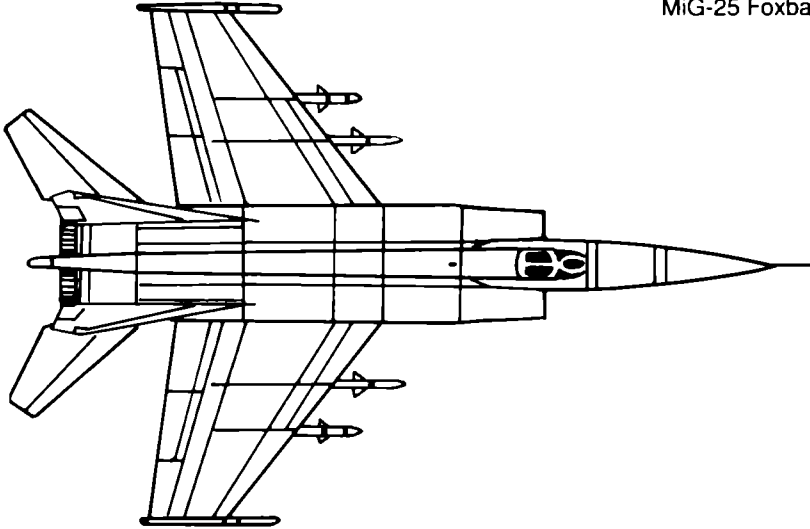

attack (the USSR has a special service arm for this purpose, the PVO). It is designed to work with ground radars, fly long and fast to find enemy bombers, then engage them with a specially designed long-ranged radar missile (the AA-6). A few are bought by client states for status reasons, but the reconnaissance version (MiG-25R) is more popular with client states, since it's 88,000' ceiling makes it immune to normal SAM or fighter interception.

### **MiG-29 Fulcrum**

*Designer/Manufacturer:* Mikoyan-Gurevich, USSR

*Role:* Fighter

*Crew:* One

*Mission Weight at Takeoff:* 18 tons

*Engine(s):* Two Tumansky R-33D turbofans for 36,600 lbs thrust

*Range:* 375-400 miles

*Ceiling:* Probably 55-65,000'

*Maximum Speed at 0':* 700 kts

*Maximum Speed at 36,000':* 1260 kts

*Armament:* One multi-barrel cannon, 6 weapons pylons

*Air-Air Radar Quality:* Medium quality and range doppler radar

*Maneuverability:* Very good to excellent

Designed to outfight the F-15, this plane is a very modern, lightweight dogfighter with superlative agility. It has engine power in excess of its weight. Common armament is AA-10 "fire-and-forget" radar-homers along with some AA-8 IR missiles. The degree of sophistication in the avionics is still unknown, but in the author's opinion it is unlikely to match the F-16.

---

---

MiG-29 Fulcrum

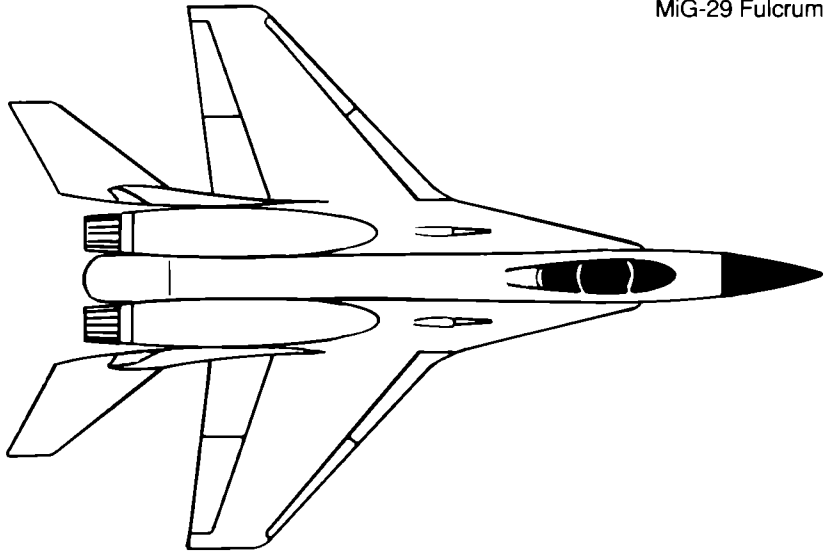

MiG-31 Foxhound

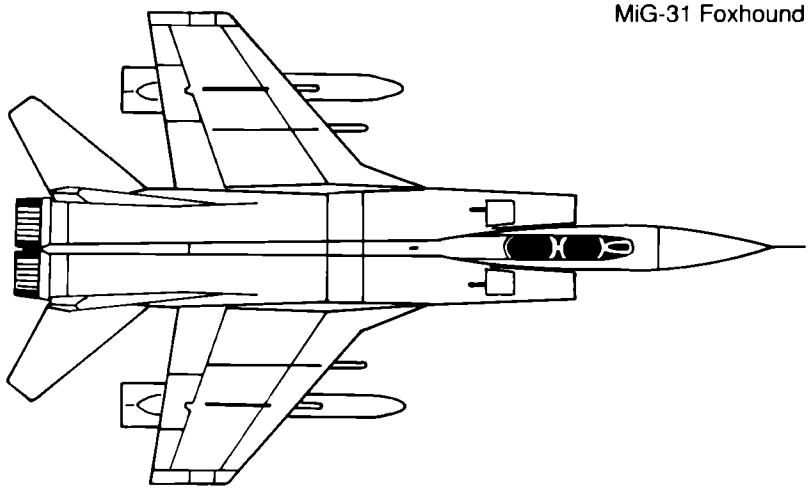

**MiG-31 Foxhound**

*Designer/Manufacturer:* Mikoyan-Gurevich, USSR  
*Role:* PVO Interceptor  
*Crew:* One



---

---

*Mission Weight at Takeoff:* 45 tons

*Engine(s):* Two turbofans or turbojets, estimated thrust 50-60,000 lbs

*Range:* 930 miles

*Ceiling:* 75,500'

*Maximum Speed at 0':* 790 kts

*Maximum Speed at 36,000':* 1400 kts

*Armament:* 4 missile recesses, 4 weapons pylons

*Air-Air Radar Quality:* Superior quality and range doppler radar

*Maneuverability:* Fair

This aircraft is a redesigned MiG-25. Although slightly slower, it is greatly improved in all other categories, especially low-altitude interceptions against both planes and cruise missiles. It is believed to carry a mix of AA-9 and AA-8 missiles, and sometimes the AA-10 as well. It probably has an internal gun too.

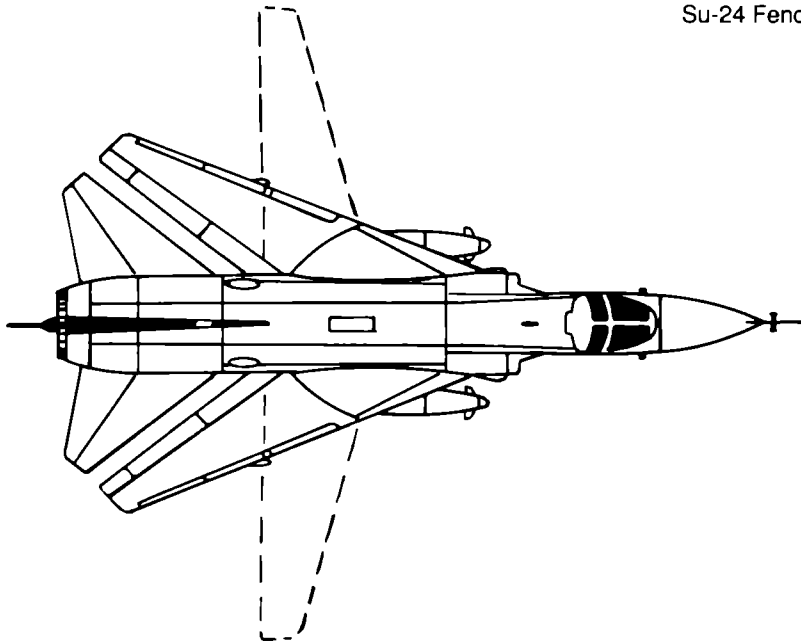

Su-24 Fencer

### **Su-24 Fencer**

*Designer/Manufacturer:* Sukhoi, USSR

*Role:* Strike Fighter & Interdictor

*Crew:* Two

*Mission Weight at Takeoff:* 43.5 tons

*Engine(s):* Two Tumansky R-29B turbofans for 50,700 lbs thrust

*Range:* 200-1100 miles (varies with mission profile and load)

*Ceiling:* 57,400'

---

---

---

---

*Maximum Speed at 0': 765 kts*

*Maximum Speed at 36,000': 1400 kts*

*Armament: 6-barrel 23mm cannon, 8 weapon pylons*

*Air-Air Radar Quality: nil, avionics designed purely for air-ground role*

*Maneuverability: Fair*

This is the most advanced air-ground attack plane built by the USSR. Externally it appears similar to the F-111, including the side-by-side seating in the cockpit. However, its armament and avionics are designed for front-line and rear-area strikes, into the teeth of enemy air defenses. Western air and ground commanders fear the Su-24 more than any other Soviet aircraft. The aircraft may carry a few AA-8's for self-defense, but it is not designed for air-to-air combat.

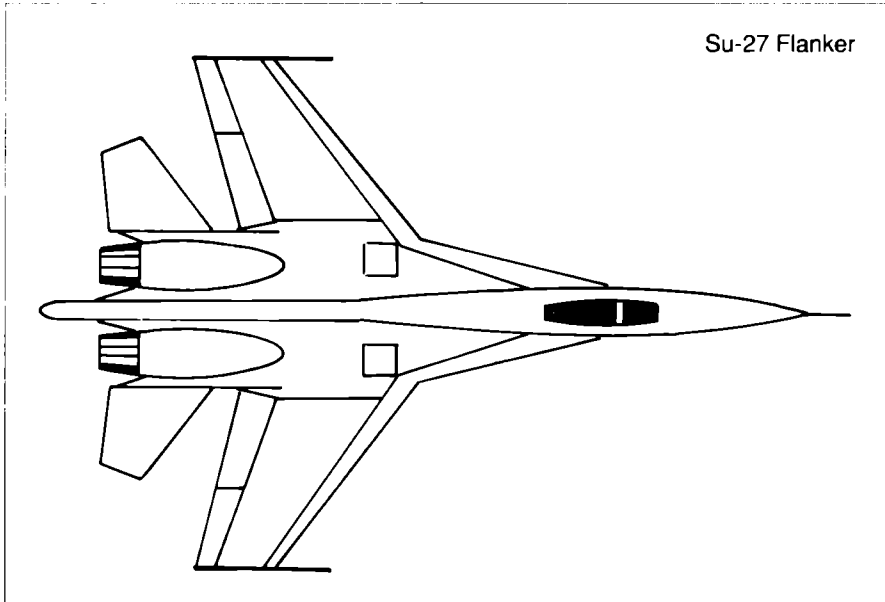

### **Su-27 Flanker**

*Designer/Manufacturer: Sukhoi, USSR*

*Role: Fighter*

*Crew: One*

*Mission Weight at Takeoff: 25 tons*

*Engine(s): Two unknown turbojets for estimated 60,000 lbs thrust*

*Range: 715 miles*

*Ceiling: Unknown, probably 60,000' or more*

*Maximum Speed at 0': 725 kts*

*Maximum Speed at 36,000': 1350 kts*

*Armament: Probably a cannon, 6 weapons pylons*

*Air-Air Radar Quality: Above average quality and range doppler radar*

*Maneuverability: Very good to excellent*

This aircraft was designed to defeat the F-14 and F-15 fighters. It is a large,

---

---

---

---

powerful dogfighter whose usual armament is probably four AA-8 and four AA-10 missiles. In comparison to the MiG-29, the Su-27 is a larger, heavier plane. It's avionics and flight controls are truly modern, the Su-27 may be the superior plane. However, in purely maneuverability the MiG-29 and ultimately F-16 should have the edge.

---

Yak-38 Forger

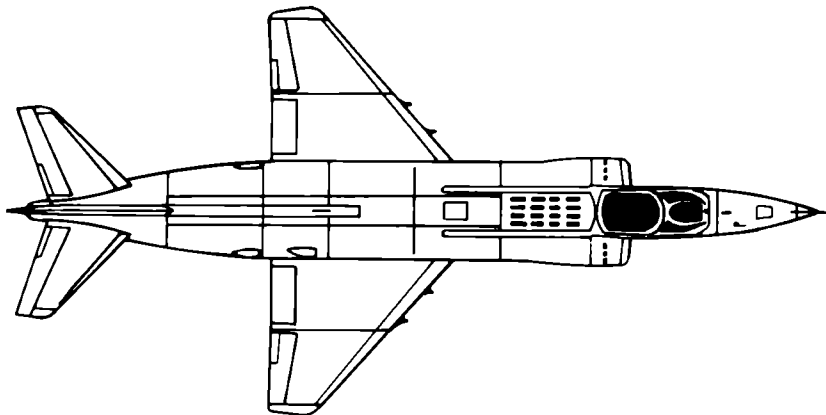

### **Yak-38 Forger**

*Designer/Manufacturer:* Yakovlev, USSR

*Role:* VTOL Fighter

*Crew:* One

*Mission Weight at Takeoff:* 12 tons

*Engine(s):* One Lyulka AL-21 vectored-thrust turbojet for 17,985 lbs thrust (no afterburner), plus two Koliesov liftjet engines

*Range:* 230 miles

*Ceiling:* 39,370'

*Maximum Speed at 0':* 535 kts

*Maximum Speed at 36,000':* 550 kts

*Armament:* 4 weapons pylons

*Air-Air Radar Quality:* Poor quality and range pulse radar

*Maneuverability:* Fair

Originally known as the Yak-36MP, this vertical take-off fighter operates from the Kiev-class aircraft carriers. These lack the equipment and deck space for conventional jets. Initially thought to be a Russian equivalent of the Harrier, the Yak-38 is considerably inferior. It has limited interception ability and very limited strike capacity. However, until this plane the Russian navy only had nothing bigger than helicopters on its warships.

---

---

---

---

Tu-26 Backfire

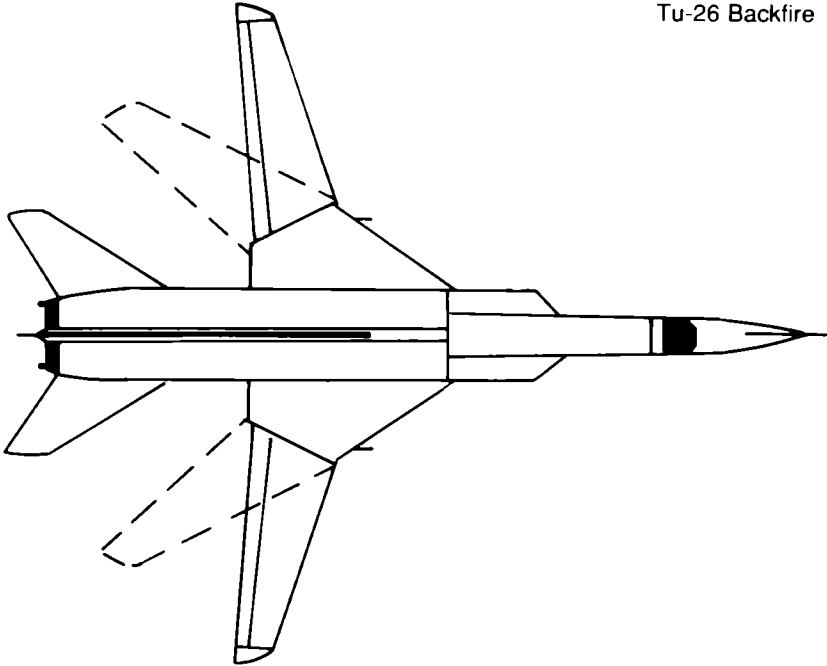

---

### **Tu-26 Backfire**

*Designer/Manufacturer:* Tupolev, USSR

*Role:* Bomber

*Crew:* Four

*Mission Weight at Takeoff:* 61 tons

*Engine(s):* Two uprated Kuznetsov NK-144 turbofans for 88,180 lbs thrust

*Range:* 3,400 miles

*Ceiling:* 55,000'

*Maximum Speed at 0':* 525 kts

*Maximum Speed at 36,000':* 970 kts

*Armament:* Three heavy Air-Surface missiles or 13 tons of bombs

*Air-Air Radar Quality:* Fair, with excellent air-surface avionics

*Maneuverability:* Very poor

Many of these swing-wing bombers are in service with the Soviet naval-air arm, carrying long-range missiles to attack hostile warships up to 2,000 miles out to sea. The Backfire's exceptionally long range and high speed, plus its powerful missiles make it a mortal threat to USN aircraft carriers. With aerial refueling it has sufficient range to get within cruise-missile-launch position of the USA. As a gesture to arms control, the USSR has removed air refueling equipment from its Air Force Backfires.

---

---

Tu-95D Bear

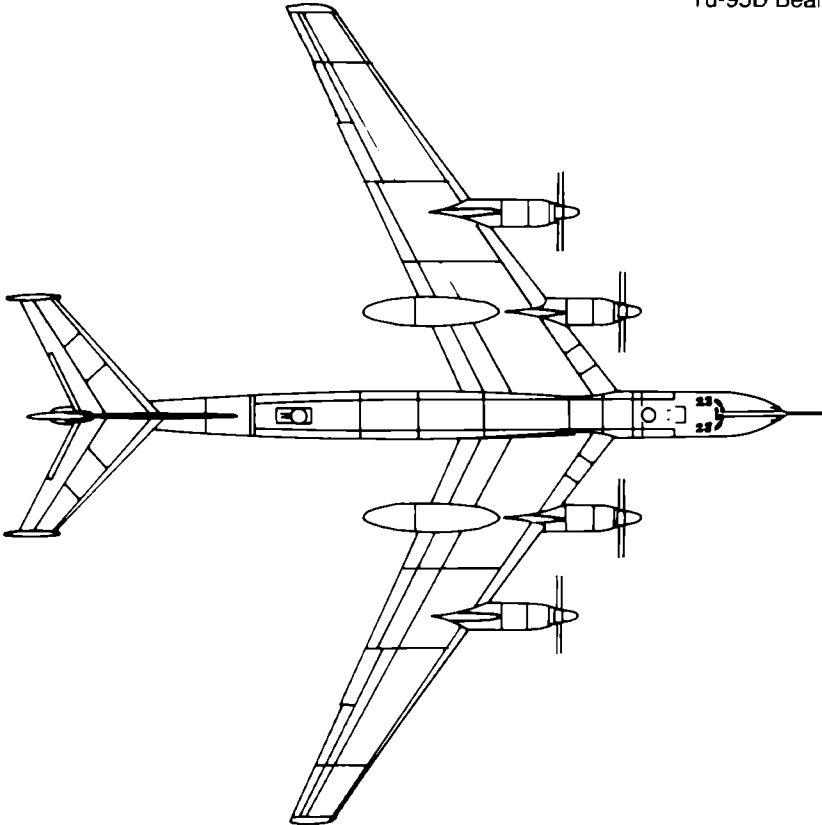

### **Tu-95D Bear**

*Designer/Manufacturer:* Tupolev, USSR

*Role:* Reconnaissance bomber

*Crew:* 7-12

*Mission Weight at Takeoff:* unknown, about 145-165 tons

*Engine(s):* four Kuznetsov NK-12MV turboprops

*Range:* 5,150 miles (7 hours endurance)

*Ceiling:* 41,000'

*Maximum Speed at 0':* 410 kts

*Maximum Speed at 36,000':* 475 kts

*Armament:* unarmed

*Air-Air Radar Quality:* Very good long-radar pulse radars

*Maneuverability:* Terrible

The Tu-95 has been the world's most sophisticated turboprop bomber for over

---

---

thirty years (it entered service in 1955). They are primarily used for long-range reconnaissance, electronic intelligence, electronic warfare (jamming) carriers, anti-ship missile carriers, and cruise-missile carriers. The "D" model is a reconnaissance version, the "H" model (on a slightly modified airframe) a cruise-missile carrier.

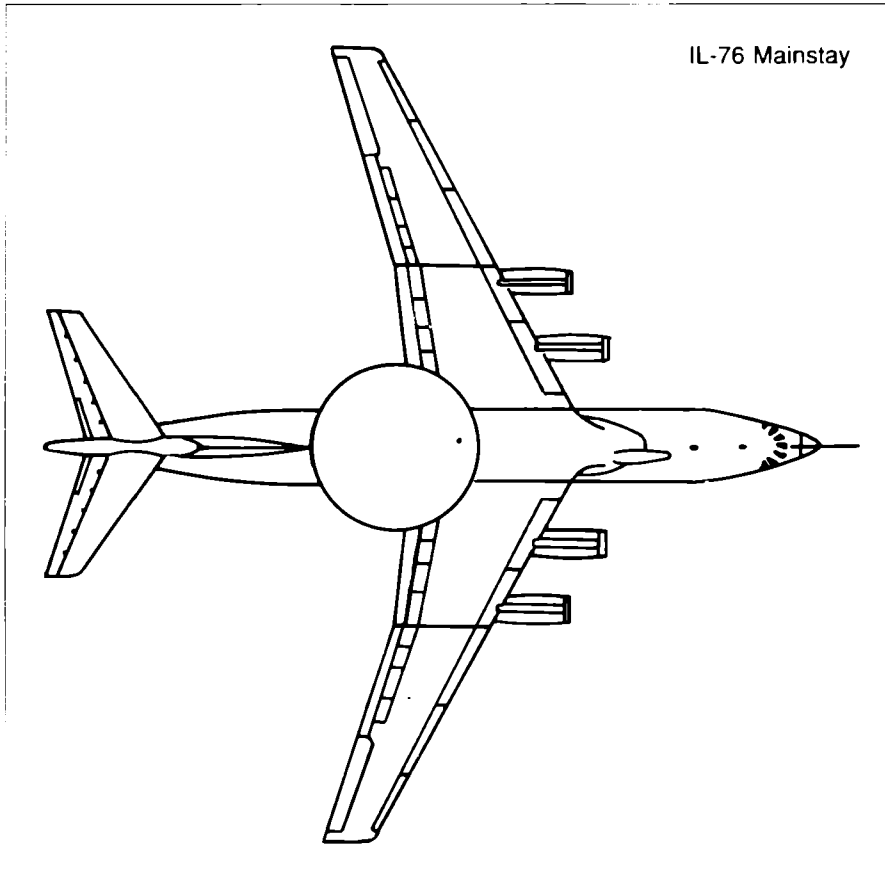

### **IL-76 Mainstay**

*Designer/Manufacturer:* Ilyushin, USSR

*Role:* Airborne Early Warning & Control (AEW&C)

*Crew:* Estimated at 15 to 20

*Mission Weight at Takeoff:* About 150 tons

*Engine(s):* four Soloviev D-30KP turboprops for 106,000 lbs thrust

*Range:* About 4,000 miles (7 hours endurance)

*Ceiling:* About 40-50,000'

*Maximum Speed at 0':* 400 kts

---

---

*Maximum Speed at 36,000':* 460 kts

*Armament:* Possibly twin 23mm tail cannon, 2-4 weapons pylons

*Air-Air Radar Quality:* Excellent long-radar doppler radars

*Maneuverability:* Terrible

The "Mainstay" is a conversion of the huge IL-76 Candid transport plane to "AWACS" duties. Its purpose is to detect enemy aircraft and low-flying missiles, and act as a mobile, airborne command post that controls friendly aircraft engaging such threats. The earlier Tu-126 "Moss" AEW&C with turboprops was a disastrous failure. Like many AEW&C planes, the IL-76 could carry a few AAMs (AA-8s or AA-10s) for self defense, as well as extensive jammers, decoys, etc.

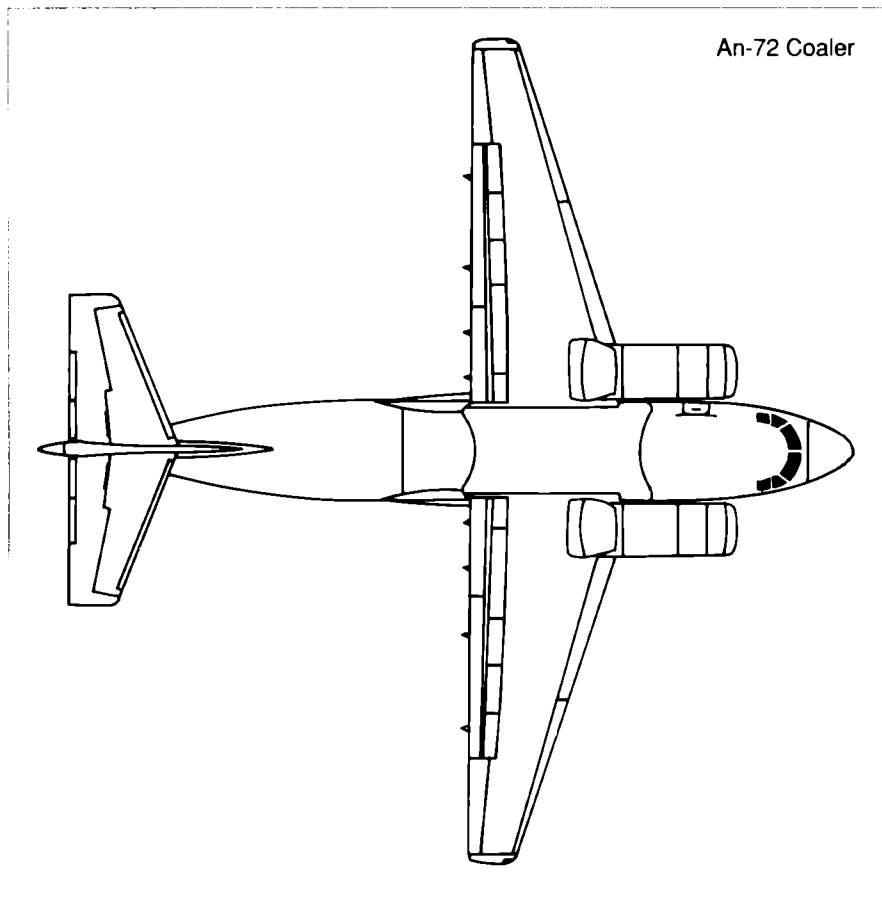

### **An-72 Coaler**

*Designer/Manufacturer:* Antonov, USSR

*Role:* Air transport

*Crew:* 3

---

---

---

---

*Mission Weight at Takeoff:* 28 tons

*Engine(s):* Two Lotarev D-36 turbofans for 28,660 lbs thrust

*Range:* 620 miles (max cargo) to 2,360 miles (no cargo)

*Ceiling:* 36,100'

*Maximum Speed at 0':* 350 kts

*Maximum Speed at 36,000':* 410 kts

*Armament:* Unarmed; can carry 32 passengers or 11 tons cargo

*Air-Air Radar Quality:* Navigational only

*Maneuverability:* Terrible for a fighter, but good for a transport

This is the latest general-purpose medium air transport of the Soviet Union. Its jet engines and short-takeoff performance make it an outstanding utility craft for transporting all types of personnel and cargo between remote airfields.



---

---

## VI Appendix

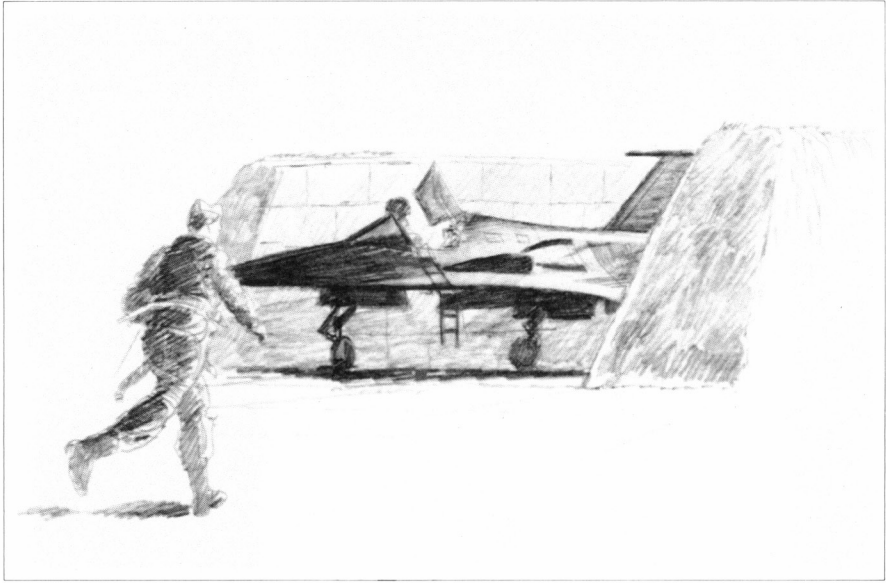

### • Glossary •

**Ace:** Pilot with five or more confirmed kills of enemy aircraft.

**Ace-of-the-Base:** Best flyer in the squadron.

**AFV:** Armored Fighting Vehicle, an armored vehicle designed for front line combat. This includes tanks, armored personnel carriers, anti-aircraft tanks, SAM missile carriers, etc.

**AGM:** Air-to-Ground Missile. Originally used by the US Air Force for missiles designed to hit land surface targets, but commonly extended to mean missiles designed for use against land or sea targets.

**ARM:** Anti-radiation Missile. Missile designed to home on enemy radar sets.

**ASM:** Air-to-Surface Missile. Often used for missiles designed to attack ships, but sometimes generalized to mean any missile launched against targets on the surface of the earth.

**Bravo Sierra:** Military words for BS, which in turn is an abbreviation for a common expletive, here indicating something especially unpleasant or unbelievable. For example: "Doing the bunny hop down the runway to a belly-flop landing, then complaining about wind sheer, is a true Bravo Sierra!"

**BVR:** Beyond Visual Range. Any engagement where you cannot visually

---

---

---

---

distinguish the target. During peacetime pilots are often prohibited from firing BVR, for fear of hitting the wrong target.

**CAP:** Combat Air Patrol. Aircraft patrolling over friendly forces. Originally it meant fighters launched from aircraft carriers, and assigned to patrol over those carriers, protecting them from air attack.

**Check your six:** Watch your tail; literally, watch the six o'clock position of your aircraft.

**Ditch:** Bail out, esp. over water.

**Driver:** Pilot.

**ECM:** Electronic Counter-measures. Devices designed to jam or fool ("spoof") enemy electronic sensors, notably radar.

**ECCM:** Electronic Counter-counter-measures. Devices designed to protect against jamming or "spoofing" by enemy ECM.

**Ego Drivers:** Pilots of the F-15 Eagle.

**Electric Jet:** F-16 Falcon.

**Fangs Out:** Seeking air-to-air victory in a dogfight, regardless of other dangers or considerations, such as worry about other enemy aircraft, your EMV, or even your altitude. See Knife Fight.

**FEBA:** Forward Edge of the Battle Area. Older NATO abbreviation for the front line or battle line with the enemy.

**FitRep:** Fitness Report. A report by commander that recommends subordinates for promotion (or not, as appropriate).

**FLOT:** Forward Line of Troops. Current NATO abbreviation for the front line or battle line with the enemy.

**Flying a desk:** Staff or command job with no flying duties.

**Frisbee:** Unofficial nickname of the F-19 Stealth Fighter.

**Knife fight:** Dogfight to the death — what happens when you go "fangs out." This situation is advantageous to low-speed, highly maneuverable planes and disadvantageous to higher speed but less maneuverable planes. However, either or both contestants can be surprised by other fighters and SAMs.

**IR:** Infrared. A portion of the electro-magnetic spectrum where the intensity of the signal is directly related to the heat of the object.

**Mike Mike:** Military words for "mm", generally referring to 20mm cannon shells. Ex: "Then I placed some Mike Mike right up his tail".

**MiG:** Mikoyan-Guryevich design bureau, which specializes in the design and construction of jet fighters for the Soviet Union. Often used as a generic name for all Soviet-built fighter aircraft (even though other bureaus contribute fighter designs).

---

---

---

---

**Niner:** Reference to the AIM-9 Sidewinder missile. The 9L version is known as the "Niner Lima", the 9M version as the "Niner Mike".

**Obsolescent:** Outdated but not yet useless; not quite obsolete.

**Promo:** Promotion.

**Pucker Factor:** Level of fear (e.g., "When those 20 Flankers jumped us, the pucker factor sure went up!").

**SAM:** Surface-to-Air Missile.

**Short Off:** Destroy an enemy airplane.

**Sierra Hotel:** Military expansion of the letters "SH", here abbreviating heat excrement. Curiously, the expression denotes admiration and excitement. For example, "Sierra Hotel, look at that guy smoke MiGs!".

**Skunk Works:** Quasi-official nickname of the Lockheed plant in Burbank, California that designs and builds top-secret aircraft.

**Smoke:** To destroy. Originally from the smoke plume emitted by burning aircraft as they fall to earth.

**Steve Canyon:** Comic strip hero who is a superlative fighter pilot.

**VVI:** Vertical Velocity Indicator. A gauge that indicates how fast a plane is ascending or descending.

**Whiskey Delta:** Derogatory and insulting description of a fighter pilot (e.g., "that Whiskey Delta couldn't even find his own airbase, much less hit it with a bomb."). Regrettably, the etymology of this term is too impolite for general publication.

**Wing Weenie:** Administrative staff officer attached to a fighter unit, but with no combat or flying duties. A mildly derogatory term.

**Zero-Zero:** Nickname for the zero-zero type ejection seat. So named because, in theory, a pilot can eject safely from a plane with zero speed and zero altitude (i.e., sitting on a runway).

## • Designers' Notes •

### The Concept

Although MicroProse is famous for its flight simulations, the last warplane simulation we released was three years ago, in 1984. During the long hiatus we debated what new plane to simulate. One group urged the F-16 "Electric Jet", an excellent close-in dogfighter and strike plane, but ultimately too similar to our famous *F-15 Strike Eagle*. Another camp suggested the ATF (Advanced Tactical Fighter). Since the Air Force hadn't selected a design, we could design all the features we thought valuable for the next generation fighter plane. But then, if we

---

---

---

---

just waited a few years, we'd probably have a real plane to simulate instead. Ultimately the F-19 partisans were victorious. Why?

We selected the stealth fighter partly for the design challenge. Much of the plane is still unknown or conjectural. Lockheed's "Skunk Works" does have a contract to design such a craft, but how many were built, much less what they look like is still highly classified.

More importantly, the stealth fighter is a unique flying experience. It is the only aircraft designed for solo missions. Modern air raids are complex operations full of specialized craft. The F-19 is the exception: it flies alone, sneaks into the heart of the enemy's defenses, accomplishes its mission, and sneaks out again. It's something like James Bond or a submarine in the air. Not since 1916 have fighter pilots gone off to duel the enemy single-handed. The challenge of an F-19 mission was just too exciting for us to ignore!

## The Design

Since 1984 MicroProse has spent considerable time and effort advancing the "state of the art" in 3-D graphics technology, especially for 8-bit microcomputers (such as the Commodore C64 and Apple II). We have never accepted that you can have either sufficient speed for flight control *or* realistic 3-D graphics, but not both on "lowly" 8-bit processors. The 8-bit versions of *Project: Stealth Fighter* bear out our belief that you can have your cake *and* eat it too!

Like all MicroProse products, this one had more ideas than the computer had memory. We sometimes joke that a game is finished when you run out of memory. Actually it's not nearly finished until you run out of memory the fifth or sixth time! You see, each time you run out of memory, you rewrite and crunch things down a little more...

Why did we include so many weapons? Well, we wanted to try dive bombing, toss bombing, strafing, missile dogfighting, photo-recon runs, and more. Part of the fun and challenge of *Project: Stealth Fighter* is discovering how each weapon works, its strengths and weaknesses, and your own tactics for your favorites.

The four regions included represent a small selection of the possibilities. Given America's global interests, a stealth fighter could be transported almost anywhere for a variety of reasons. In fact, we're pondering the wisdom of releasing additional "scenario disks" with new regions. Let us know if you want more, and your personal favorites for new scenarios.

## The Design Team

Simulations such as *Project: Stealth Fighter* require a creative team to produce. Here the keystone man was the chief programmer and designer, Jim Synoski. This simulation was his daily companion for a year and a half. Jim's a quiet guy, but he's one of the best in the America when it comes to real-time 6502 code! Jim was ably assisted by Edward "Chip" Hill, who set up the 3-D data tools and data processing, not to mention Dan Chang's yeoman work putting together the data structures, screen output, and logic for the starting and ending options. Dan also worked with

---

---

---

---

graphics expert Gregg Tavares and artist Michele Mahan to create the title screen.

Speaking of artists, the chief of computer graphics at MicroProse, Michael Haire, was the deft hand behind many of the screen designs. Michele Mahan handled the rest. After more than a year in development, Michael's predictable reaction to more art demands was "What? You want *more* graphics for *Stealth*?" Another unsung artist is composer and programmer Ken Lagace, who created the theme music and sound effects.

All three of MicroProse's game designers/researchers were involved. Arnold Hendrick hung around the longest, being in at the start and finish, while Lawrence Schick contributed his ideas during a middle period. Ed Bever set up the Central Europe and North Cape scenarios despite some tough deadlines. Incidentally, the descriptions of those regions in this manual are written by him. Even Sid Meier couldn't resist getting into the act, tossing around algorithms and making pungent suggestions — a favorite pastime of almost everyone in the MicroProse R&D group!

Finally, the testing and quality control staff at MicroProse did everything possible to insure that bugs were found and exterminated before the product reached you. We hate it when games lock up or crash unexpectedly, especially in the middle of a CMOH mission! People like Larry Martin and Al Roireau work day and night (literally) to insure it doesn't happen to you!

## Secrets & Politics

When creating simulations of military equipment that are partly or entirely classified, such as the Stealth Fighter, MicroProse has a standing policy: use only unclassified sources. Although we talk to real pilots and military personnel, we neither solicit nor use any classified information. Naturally, we must make some educated guesses. However, the amount of information available to the public is quite remarkable. In the past our "guesses" have turned out correct more often than we imagined.

Our selection of regions for game scenarios is not intended to convey a political viewpoint, or promote antipathy toward any nationality or race. Military forces are required to fight whomever their government says is the enemy (even other family members in a civil war). In this simulation, as in all our products, political circumstances of the day dictate who is hostile to whom. In the late 1980's problems with Libya, Iran, and the USSR loom large in America's war planning.

In summary, military simulations like *Project: Stealth Fighter* allow us to experience the vicarious thrills of combat flying without have to declare war on anyone, much less hurt anybody. We enjoyed creating *Project: Stealth Fighter*. We're sure you'll enjoy flying her.



---

---

## **Credits**

### **Game Design**

Jim Synoski and Arnold Hendrick

### **Original C-64 Programming**

Jim Synoski  
with Dan Chang, Edward N. Hill III,  
and Gregg Tavares

### **Computer Graphics**

Michael Haire  
with Michele Mahan

### **Music & Sound Effects**

Ken Lagace

### **Game Scenarios**

Arnold Hendrick & Ed Bever

### **Manual**

Arnold Hendrick

### **Quality Assurance**

Alan Roireau, Larry Martin

### **Playtesting**

Alan Roireau, Chris Taormino, Ed Bever, Sid Meier,  
Bill Stealey, Steve Meyer, Larry Martin

### **Cover Art**

Tom Freeman

### **Print Graphics**

Mark Ciola, Art Director  
with Arnold Hendrick, Jeff Johnson and John Emory





---

---

## Limited Warranty

Neither MICROPROSE SOFTWARE, INC., nor any dealer or distributor makes any warranty, express or implied, with respect to this manual, the disk or any related item, their quality, performance, merchantability, or fitness for any purpose. It is the responsibility solely of the purchaser to determine the suitability of the products for any purpose. Some states do not allow limitations on implied warranties or how long an implied warranty lasts, so the above limitation may not apply to you.

As a condition precedent to the warranty coverage provided below and to ensure identification, the original purchaser must complete and mail to MicroProse Software, Inc., 180 Lakefront Drive, Hunt Valley, Maryland 21030, within 30 days after purchase, the Registration/Warranty card enclosed in this product. To the original purchaser only, MicroProse Software, Inc. warrants the media to be free from defects in material for 90 days. If during the first 90 days after purchase a defect in media should occur, the software may be returned to MicroProse Software, Inc., who will replace the media at no charge. If at any time after the initial 90 day period your media becomes defective, the media may be returned to MICROPROSE SOFTWARE for replacement at a \$10 service charge.

In no case will MicroProse Software, Inc. be held liable for direct, indirect or incidental damages resulting from any defect or omission in the manual, or other related items and processes, including, but not limited to, any interruption of service, loss of business, anticipated profit, or other consequential damages. Some states do not allow the exclusion or limitation of incidental or consequential damages, so the above limitation or exclusion may not apply to you.

This warranty gives you specific legal rights, and you may also have other rights which vary from state to state.

**IMPORTANT:** The above warranty does not apply if the you make any unauthorized attempt to modify or duplicate the product, or if the product has been damaged by accident or abuse.



2, Market Place, Tetbury, Gloucestershire GL8 8DA

Tel:(0666)54326

Fax:(0666)54331 Tlx 43422MPS UK G

---

---

## **Copyright Notice**

Copyright ©1987 by MicroProse Software, Inc., all rights reserved.

This manual and the computer programs and audiovisuals on the accompanying floppy disks, which are described by this manual, are copyrighted and contain proprietary information belonging to MicroProse Software, Inc. No one may give or sell copies of this manual or the accompanying disks or of listings of the programs on the disks to any person or institution, except as provided for by the written agreement with MicroProse Software, Inc. No one may copy, photocopy, reproduce, translate this manual or reduce it to machine readable form, in whole or in part, without the prior written consent of MicroProse Software, Inc. Any person/ persons reproducing any portion of this program, in any media, for any reason, shall be guilty of Copyright Violation, and shall be subject to civil liability at the discretion of the copyright holder.



2, Market Place, Tetbury, Gloucestershire GL8 8DA

Tel:(0666)54326

Fax:(0666)54331 Tlx:43422MPS UK G

MicroProse Software enjoys an international reputation for producing realistic simulations on many exciting topics.

**Airborne Ranger™** is MicroProse's new game of real-time man-to-man action. You're dropped behind enemy lines to sneak and fight your way to one of many different objectives. Sensational animated graphics combined with MicroProse's attention to detail will keep you at the battlefield day after day!

**Pirates™** is the smash hit historical adventure on the Spanish Main, 1560-1700. You take the role of a fortune-hunter in the Caribbean, complete with sailing, smuggling, sea battles, land campaigns, duels, political entanglements and love affairs. Will your career lead to beggary in the gutter, or fame and riches?

**Gunship™** is the best-selling simulation of the world's most formidable attack helicopter, the AH-64A "Apache" of the U.S. Army. It includes 3-D "out the cockpit" graphics, hundreds of different missions in five regions of the world, as well as the close attention to realistic detail that is the trademark of MicroProse simulations.

**Silent Service™** simulates undersea warfare in the Pacific during WWII. You command an American submarine in specific convoy battles, or entire two-month war patrols hunting enemy shipping across the vast Pacific.

**F-15 Strike Eagle™** is the world-famous simulation of the world-class fighter used in the U.S. Air Force. It includes scenarios from seven different trouble spots around the world.

**Acro-Jet™** introduces you to the world of competitive aerobatic and stunt flying. The aircraft is the BD-5J jet. You fly in ten different events, a Pentathlon, a Decathlon, plus a "judge your own" event.

The "Command Series" are accelerated-real-time strategic simulations of great historical campaigns. The three titles available are **Conflict in Vietnam™** (the war in Southeast Asia, 1954-72), **Crusade in Europe™** (from D-Day to the Rhine, 1944), and **Decision in the Desert™** (the British against Rommel in the African desert, 1940-42).



2, Market Place, Tetbury, Gloucestershire GL8 8DA

Tel:(0666)54326

Fax:(0666)54331 Tlx:43422MPS UK G